

FOD814 Series, FOD617 Series, FOD817 Series 4-Pin High Operating Temperature Phototransistor Optocouplers

Features

- AC input response (FOD814 only)
- Applicable to Pb-free IR reflow soldering
- Compact 4-pin package
- Current transfer ratio in selected groups:

| | |
|-------------------|-------------------|
| FOD617A: 40–80% | FOD817: 50–600% |
| FOD617B: 63–125% | FOD817A: 80–160% |
| FOD617C: 100–200% | FOD817B: 130–260% |
| FOD617D: 160–320% | FOD817C: 200–400% |
| FOD814: 20–300% | FOD817D: 300–600% |
| FOD814A: 50–150% | |
- C-UL, UL and VDE approved
- High input-output isolation voltage of 5000Vrms
- Minimum BV_{CEO} of 70V guaranteed
- Higher operating temperatures (versus H11AXXX counterparts)

Applications

FOD814 Series

- AC line monitor
- Unknown polarity DC sensor
- Telephone line interface

FOD617 and FOD817 Series

- Power supply regulators
- Digital logic inputs
- Microprocessor inputs

Description

The FOD814 consists of two gallium arsenide infrared emitting diodes, connected in inverse parallel, driving a silicon phototransistor output in a 4-pin dual in-line package. The FOD617/817 Series consists of a gallium arsenide infrared emitting diode driving a silicon phototransistor in a 4-pin dual in-line package.

Functional Block Diagram

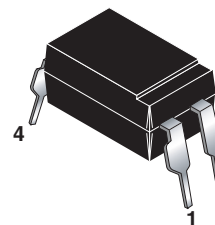
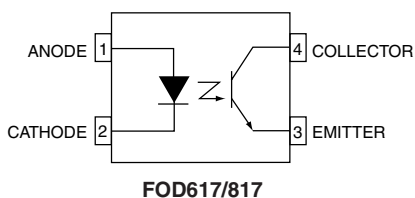
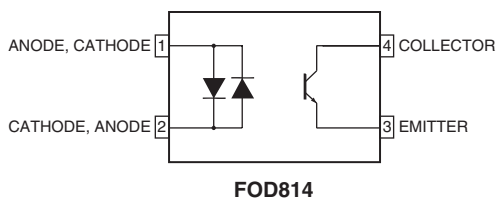

Absolute Maximum Ratings ($T_A = 25^\circ\text{C}$ Unless otherwise specified.)

| Symbol | Parameter | Value | | Units |
|---------------------|----------------------------------|----------------|--------------------------|----------------------------|
| | | FOD814 | FOD617/817 | |
| TOTAL DEVICE | | | | |
| T_{STG} | Storage Temperature | -55 to +150 | | $^\circ\text{C}$ |
| T_{OPR} | Operating Temperature | -55 to +105 | -55 to +110 | $^\circ\text{C}$ |
| T_{SOL} | Lead Solder Temperature | 260 for 10 sec | | $^\circ\text{C}$ |
| P_{TOT} | Total Power Dissipation | 200 | | mW |
| EMITTER | | | | |
| I_F | Continuous Forward Current | ± 50 | 50 | mA |
| V_R | Reverse Voltage | - | 6 | |
| P_D | Power Dissipation | 70 | | mW |
| | Derate above 100°C | 1.7 | | $\text{mW}/^\circ\text{C}$ |
| DETECTOR | | | | |
| V_{CEO} | Collector-Emitter Voltage | 70 | | V |
| V_{ECO} | Emitter-Collector Voltage | 6 | 6 (FOD817) 7 (FOD617) | V |
| I_C | Continuous Collector Current | 50 | | mA |
| P_C | Collector Power Dissipation | 150 | | mW |
| | Derate above 90°C | 2.9 | | $\text{mW}/^\circ\text{C}$ |

Electrical Characteristics ($T_A = 25^\circ\text{C}$ Unless otherwise specified.)

Individual Component Characteristics

| Symbol | Parameter | Device | Test Conditions | Min. | Typ.* | Max. | Unit |
|-----------------|-------------------------------------|-----------|---------------------------------|------|-------|------|---------------|
| EMITTER | | | | | | | |
| V_F | Forward Voltage | FOD814 | $I_F = \pm 20\text{mA}$ | – | 1.2 | 1.4 | V |
| | | FOD617 | $I_F = 60\text{mA}$ | – | 1.35 | 1.65 | |
| | | FOD817 | $I_F = 20\text{mA}$ | – | 1.2 | 1.4 | |
| I_R | Reverse Leakage Current | FOD617 | $V_R = 6.0\text{V}$ | – | 0.001 | 10 | μA |
| | | FOD817 | $V_R = 4.0\text{V}$ | – | – | 10 | |
| C_t | Terminal Capacitance | FOD814 | $V = 0, f = 1\text{kHz}$ | – | 50 | 250 | pF |
| | | FOD617 | $V = 0, f = 1\text{kHz}$ | – | 30 | 250 | |
| | | FOD817 | $V = 0, f = 1\text{kHz}$ | – | 30 | 250 | |
| DETECTOR | | | | | | | |
| I_{CEO} | Collector Dark Current | FOD814 | $V_{CE} = 20\text{V}, I_F = 0$ | – | – | 100 | nA |
| | | FOD617C/D | $V_{CE} = 10\text{V}, I_F = 0$ | – | 1 | 100 | |
| | | FOD617A/B | $V_{CE} = 10\text{V}, I_F = 0$ | – | 1 | 50 | |
| | | FOD817 | $V_{CE} = 20\text{V}, I_F = 0$ | – | – | 100 | |
| BV_{CEO} | Collector-Emitter Breakdown Voltage | FOD814 | $I_C = 0.1\text{mA}, I_F = 0$ | 70 | – | – | V |
| | | FOD617 | $I_C = 100\mu\text{A}, I_F = 0$ | 70 | – | – | |
| | | FOD817 | $I_C = 0.1\text{mA}, I_F = 0$ | 70 | – | – | |
| BV_{ECO} | Emitter-Collector Breakdown Voltage | FOD814 | $I_E = 10\mu\text{A}, I_F = 0$ | 6 | – | – | V |
| | | FOD617 | $I_E = 10\mu\text{A}, I_F = 0$ | 7 | – | – | |
| | | FOD817 | $I_E = 10\mu\text{A}, I_F = 0$ | 6 | – | – | |

Transfer Characteristics ($T_A = 25^\circ\text{C}$ Unless otherwise specified.)

| Symbol | DC Characteristic | Device | Test Conditions | Min. | Typ.* | Max. | Unit |
|---------------|--------------------------------------|---------|--|------|-------|------|------|
| CTR | Current Transfer Ratio | FOD814 | $I_F = \pm 1\text{mA}, V_{CE} = 5\text{V}^{(1)}$ | 20 | – | 300 | % |
| | | FOD814A | | 50 | – | 150 | |
| | | FOD617A | $I_F = 10\text{mA}, V_{CE} = 5\text{V}^{(1)}$ | 40 | – | 80 | |
| | | FOD617B | | 63 | – | 125 | |
| | | FOD617C | | 100 | – | 200 | |
| | | FOD617D | | 160 | – | 320 | |
| | | FOD617A | $I_F = 1\text{mA}, V_{CE} = 5\text{V}^{(1)}$ | 13 | – | – | |
| | | FOD617B | | 22 | – | – | |
| | | FOD617C | | 34 | – | – | |
| | | FOD617D | | 56 | – | – | |
| | | FOD817 | $I_F = 5\text{mA}, V_{CE} = 5\text{V}^{(1)}$ | 50 | – | 600 | |
| | | FOD817A | | 80 | – | 160 | |
| | | FOD817B | | 130 | – | 260 | |
| | | FOD817C | | 200 | – | 400 | |
| FOD817D | 300 | – | | 600 | | | |
| $V_{CE(sat)}$ | Collector-Emitter Saturation Voltage | FOD814 | $I_F = \pm 20\text{mA}, I_C = 1\text{mA}$ | – | 0.1 | 0.2 | V |
| | | FOD617 | $I_F = 10\text{mA}, I_C = 2.5\text{mA}$ | – | – | 0.4 | |
| | | FOD817 | $I_F = 20\text{mA}, I_C = 1\text{mA}$ | – | 0.1 | 0.2 | |

*Typical values at $T_A = 25^\circ\text{C}$

Transfer Characteristics (Continued) ($T_A = 25^\circ\text{C}$ Unless otherwise specified.)

| Symbol | AC Characteristic | Device | Test Conditions | Min. | Typ.* | Max. | Unit |
|--------|----------------------|--------|---|------|-------|------|---------------|
| f_C | Cut-Off Frequency | FOD814 | $V_{CE} = 5\text{V}$, $I_C = 2\text{mA}$, $R_L = 100\Omega$, -3dB | 15 | 80 | – | kHz |
| t_r | Response Time (Rise) | FOD814 | $V_{CE} = 2\text{V}$, $I_C = 2\text{mA}$, $R_L = 100\Omega^{(2)}$ | – | 4 | 18 | μs |
| | | FOD617 | | | | | |
| | | FOD817 | | | | | |
| t_f | Response Time (Fall) | FOD814 | | – | 3 | 18 | μs |
| | | FOD617 | | | | | |
| | | FOD817 | | | | | |

Isolation Characteristics

| Symbol | Characteristic | Device | Test Conditions | Min. | Typ.* | Max. | Units |
|-----------|---|--------|---|--------------------|--------------------|------|----------|
| V_{ISO} | Input-Output Isolation Voltage ⁽³⁾ | FOD814 | $f = 60\text{Hz}$, $t = 1\text{ min}$, $I_{I-O} \leq 2\mu\text{A}$ | 5000 | | | Vac(rms) |
| | | FOD617 | | | | | |
| | | FOD817 | | | | | |
| R_{ISO} | Isolation Resistance | FOD814 | $V_{I-O} = 500\text{VDC}$ | 5×10^{10} | 1×10^{11} | – | Ω |
| | | FOD617 | | | | | |
| | | FOD817 | | | | | |
| C_{ISO} | Isolation Capacitance | FOD814 | $V_{I-O} = 0$, $f = 1\text{ MHz}$ | | 0.6 | 1.0 | pf |
| | | FOD617 | | | | | |
| | | FOD817 | | | | | |

*Typical values at $T_A = 25^\circ\text{C}$

Notes:

1. Current Transfer Ratio (CTR) = $I_C/I_F \times 100\%$.
2. For test circuit setup and waveforms, refer to page 4.
3. For this test, Pins 1 and 2 are common, and Pins 3 and 4 are common.

Typical Electrical/Optical Characteristics ($T_A = 25^\circ\text{C}$ Unless otherwise specified.)

Fig. 1 Collector Power Dissipation vs. Ambient Temperature (FOD814)

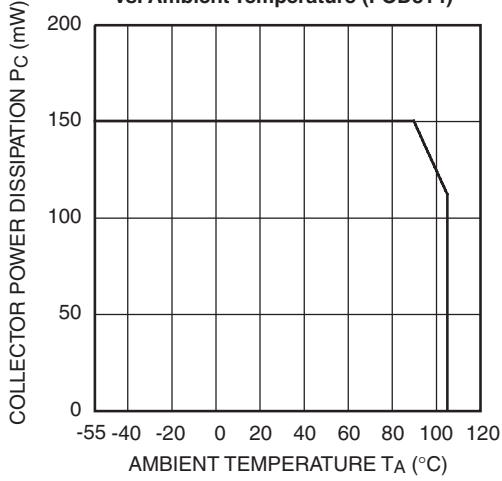

Fig. 2 Collector Power Dissipation vs. Ambient Temperature (FOD617/817)

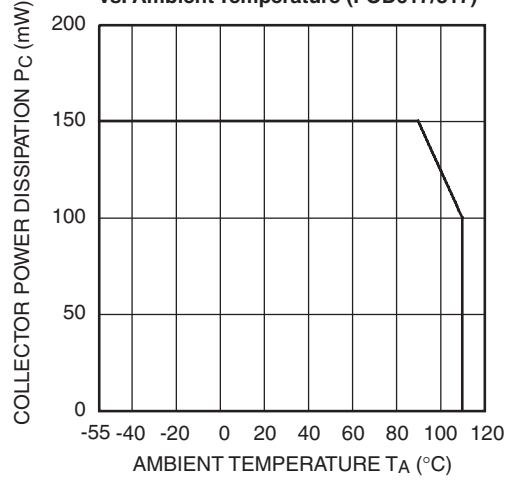

Fig. 3 Collector-Emitter Saturation Voltage vs. Forward Current

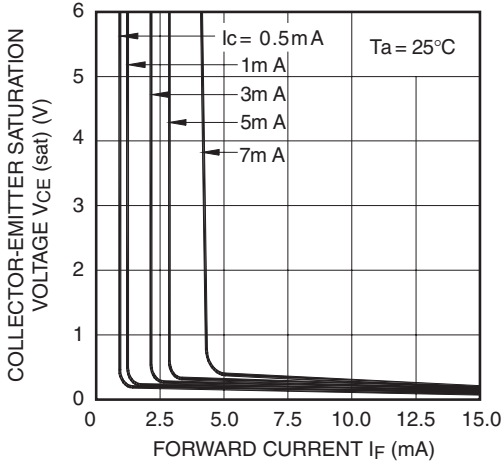

Fig. 4 Forward Current vs. Forward Voltage (FOD814)

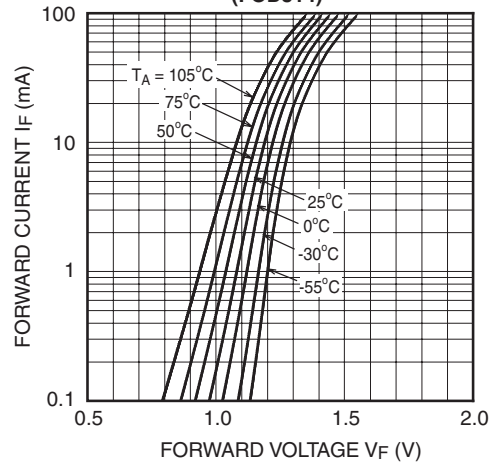

Fig. 5 Forward Current vs. Forward Voltage (FOD617/817)

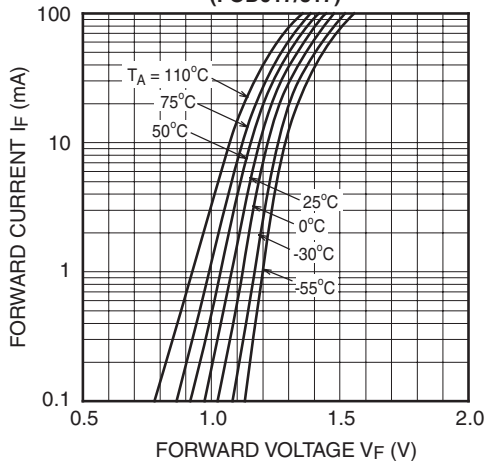
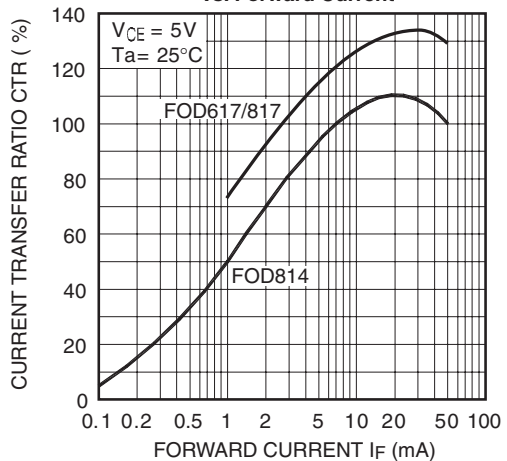

Fig. 6 Current Transfer Ratio vs. Forward Current



Typical Electrical/Optical Characteristics (Continued) ($T_A = 25^\circ\text{C}$ Unless otherwise specified.)

Fig. 7 Collector Current vs. Collector-Emitter Voltage (FOD814)

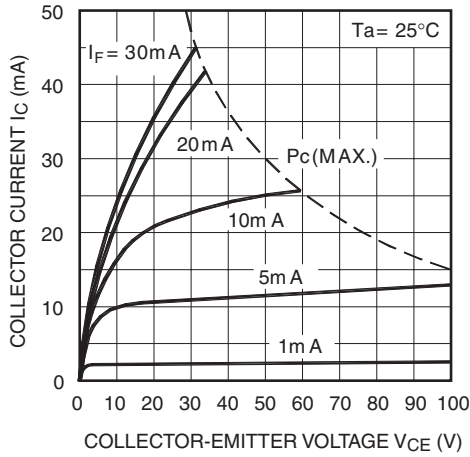

Fig. 8 Collector Current vs. Collector-Emitter Voltage (FOD617/817)

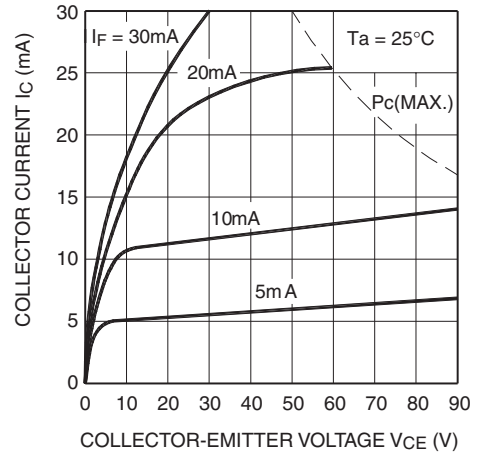

Fig. 9 Relative Current Transfer Ratio vs. Ambient Temperature

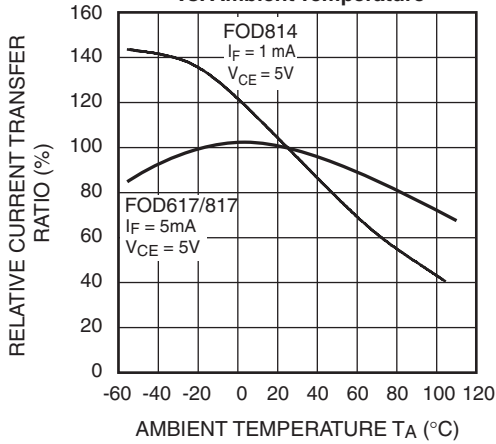

Fig. 10 Collector-Emitter Saturation Voltage vs. Ambient Temperature

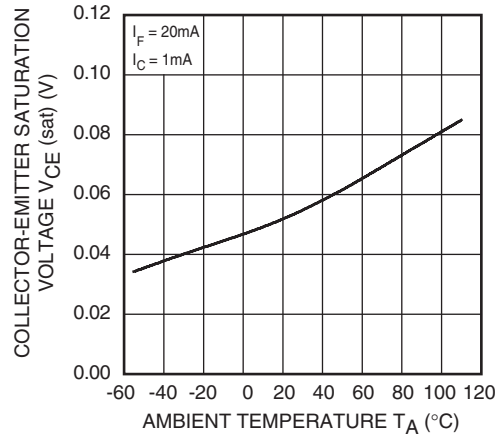

Fig. 11 LED Power Dissipation vs. Ambient Temperature (FOD814)

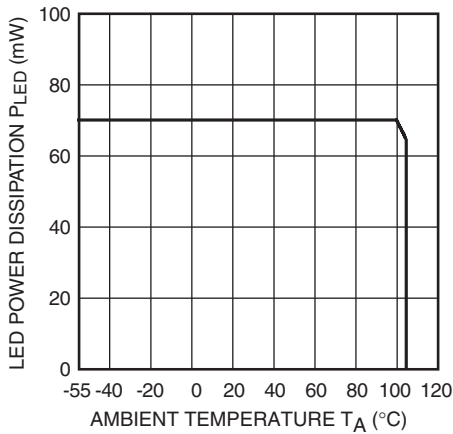
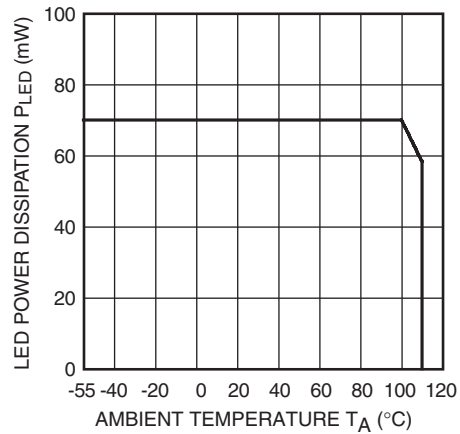

Fig. 12 LED Power Dissipation vs. Ambient Temperature (FOD617/817)



Typical Electrical/Optical Characteristics (Continued) ($T_A = 25^\circ\text{C}$ Unless otherwise specified.)

Fig. 13 Response Time vs. Load Resistance

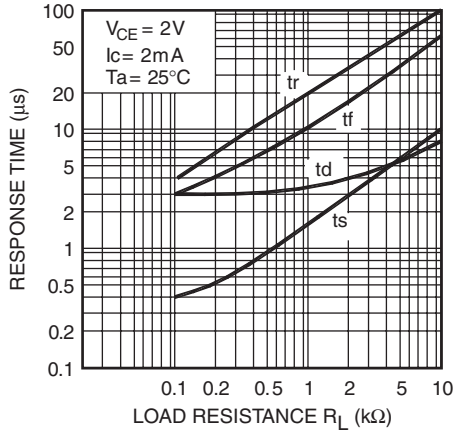

Fig. 14 Frequency Response

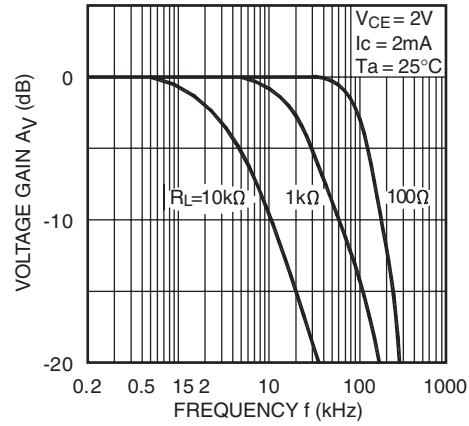
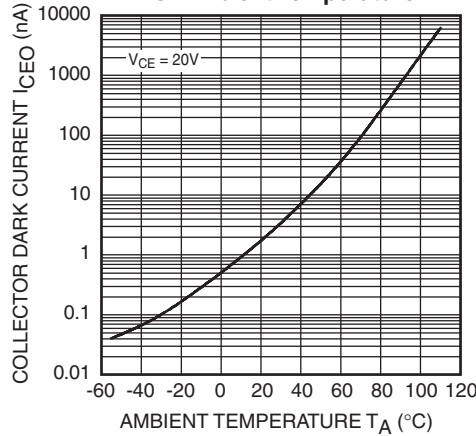
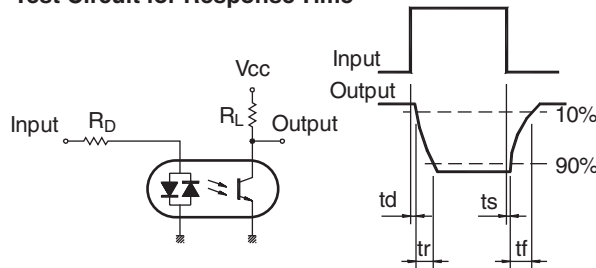

Fig. 15 Collector Dark Current vs. Ambient Temperature



Test Circuit for Response Time



Test Circuit for Frequency Response

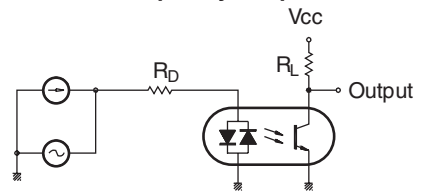

Package Dimensions (Through Hole)

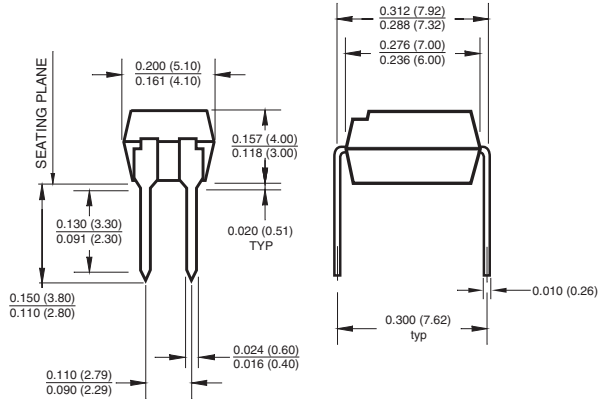

Package Dimensions (Surface Mount)

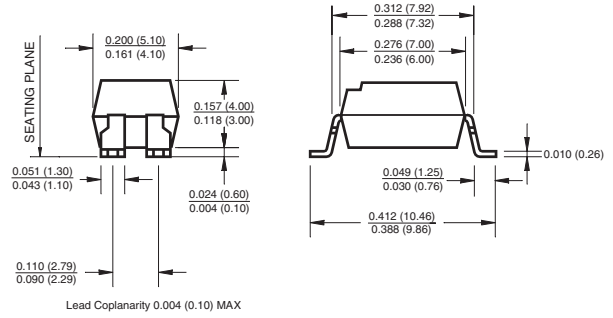

Package Dimensions (0.4" Lead Spacing)

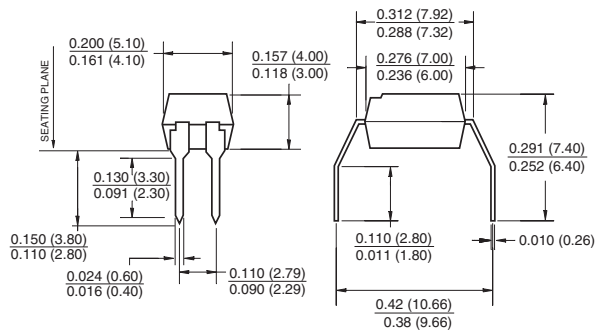

Footprint Dimensions (Surface Mount)

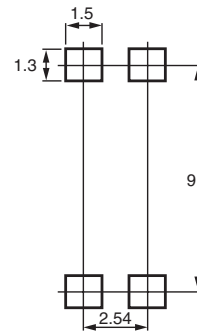

Note:

All dimensions are in inches (millimeters).

Ordering Information

| Option | Part Number Example | Description |
|--------|---------------------|--|
| S | FOD814S | Surface Mount Lead Bend |
| SD | FOD814SD | Surface Mount; Tape and reel |
| W | FOD814W | 0.4" Lead Spacing |
| 300 | FOD814300 | VDE Approved |
| 300W | FOD814300W | VDE Approved, 0.4" Lead Spacing |
| 3S | FOD8143S | VDE Approved, Surface Mount |
| 3SD | FOD8143SD | VDE Approved, Surface Mount, Tape & Reel |

Marking Information

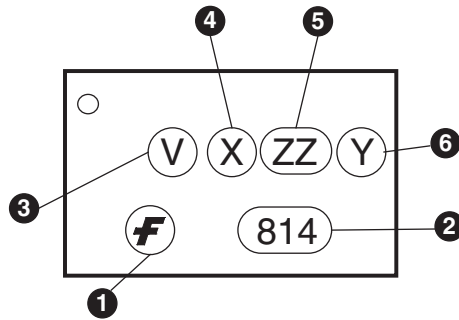

| Definitions | |
|-------------|--|
| 1 | Fairchild logo |
| 2 | Device number |
| 3 | VDE mark (Note: Only appears on parts ordered with VDE option – See order entry table) |
| 4 | One digit year code |
| 5 | Two digit work week ranging from '01' to '53' |
| 6 | Assembly package code |

Carrier Tape Specifications

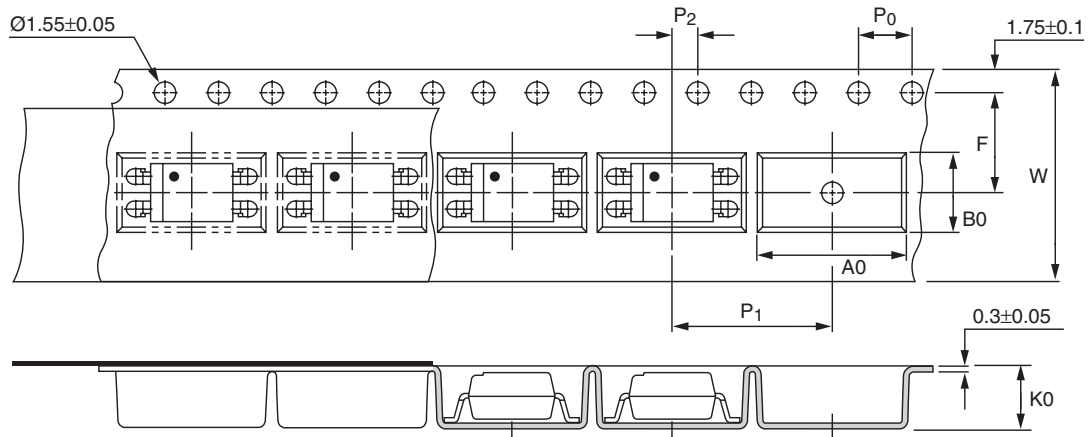

Note:

All dimensions are in millimeters.

| Description | Symbol | Dimensions in mm (inches) |
|--|--------|---------------------------|
| Tape wide | W | 16 ± 0.3 (.63) |
| Pitch of sprocket holes | P_0 | 4 ± 0.1 (.15) |
| Distance of compartment | F | 7.5 ± 0.1 (.295) |
| | P_2 | 2 ± 0.1 (.079) |
| Distance of compartment to compartment | P_1 | 12 ± 0.1 (.472) |
| Compartment | A_0 | 10.45 ± 0.1 (.411) |
| | B_0 | 5.30 ± 0.1 (.209) |
| | K_0 | 4.25 ± 0.1 (.167) |

Lead Free Recommended IR Reflow Condition

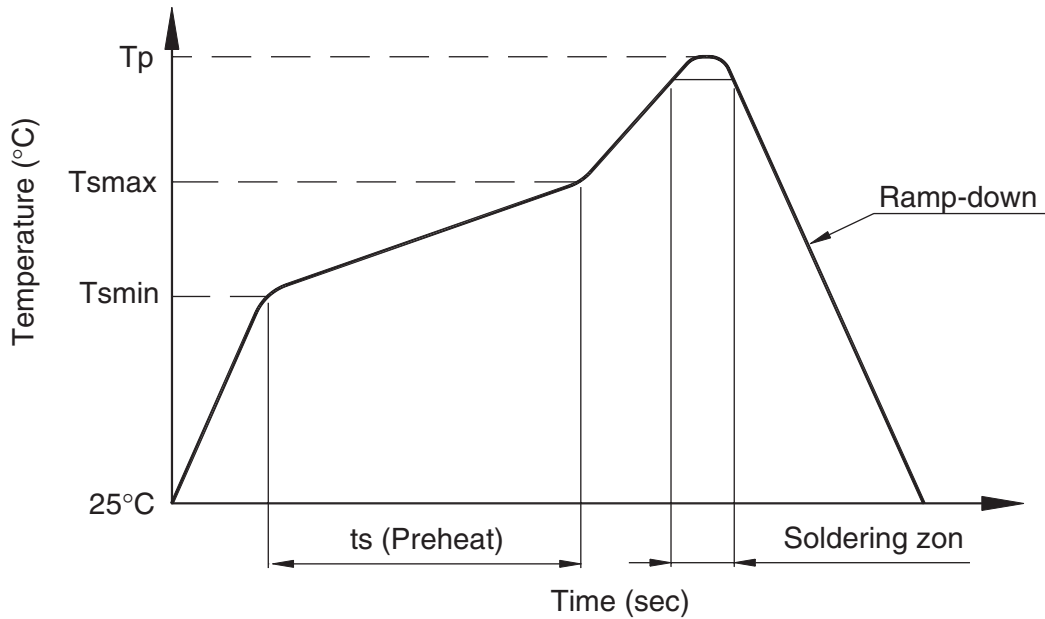

| Profile Feature | Pb-Sn solder assembly | Lead Free assembly |
|---|-------------------------------|-------------------------------|
| Preheat condition (T _{smín} -T _{smáx} / t _s) | 100°C ~ 150°C 60 ~ 120 sec | 150°C ~ 200°C 60 ~ 120 sec |
| Melt soldering zone | 183°C 60 ~ 120 sec | 217°C 30 ~ 90 sec |
| Peak temperature (T _p) | 240 +0/-5°C | 260 +0/-5°C |
| Ramp-down rate | 6°C/sec max. | 6°C/sec max. |

Recommended Wave Soldering condition

| Profile Feature | For all solder assembly |
|------------------------------------|-------------------------|
| Peak temperature (T _p) | Max 260°C for 10 sec |

TRADEMARKS

The following are registered and unregistered trademarks Fairchild Semiconductor owns or is authorized to use and is not intended to be an exhaustive list of all such trademarks.

| | | | | |
|--------------------------------------|---------------------|---------------|---------------------|-----------------|
| ACEx™ | FAST® | ISOPLANAR™ | PowerEdge™ | SuperFET™ |
| ActiveArray™ | FASTr™ | LittleFET™ | PowerSaver™ | SuperSOT™-3 |
| Bottomless™ | FPS™ | MICROCOUPLER™ | PowerTrench® | SuperSOT™-6 |
| Build it Now™ | FRFET™ | MicroFET™ | QFET® | SuperSOT™-8 |
| CoolFET™ | GlobalOptoisolator™ | MicroPak™ | QS™ | SyncFET™ |
| CROSSVOLT™ | GTO™ | MICROWIRE™ | QT Optoelectronics™ | TCM™ |
| DOME™ | HiSeC™ | MSX™ | Quiet Series™ | TinyLogic® |
| EcoSPARK™ | I ² C™ | MSXPro™ | RapidConfigure™ | TINYOPTO™ |
| E ² CMOS™ | i-Lo™ | OCX™ | RapidConnect™ | TruTranslation™ |
| EnSigna™ | ImpliedDisconnect™ | OCXPro™ | μSerDes™ | UHC™ |
| FACT™ | IntelliMAX™ | OPTOLOGIC® | ScalarPump™ | UniFET™ |
| FACT Quiet Series™ | | OPTOPLANAR™ | SILENT SWITCHER® | UltraFET® |
| Across the board. Around the world.™ | | PACMAN™ | SMART START™ | VCX™ |
| The Power Franchise® | | POP™ | SPM™ | Wire™ |
| Programmable Active Droop™ | | Power247™ | Stealth™ | |

DISCLAIMER

FAIRCHILD SEMICONDUCTOR RESERVES THE RIGHT TO MAKE CHANGES WITHOUT FURTHER NOTICE TO ANY PRODUCTS HEREIN TO IMPROVE RELIABILITY, FUNCTION OR DESIGN. FAIRCHILD DOES NOT ASSUME ANY LIABILITY ARISING OUT OF THE APPLICATION OR USE OF ANY PRODUCT OR CIRCUIT DESCRIBED HEREIN; NEITHER DOES IT CONVEY ANY LICENSE UNDER ITS PATENT RIGHTS, NOR THE RIGHTS OF OTHERS. THESE SPECIFICATIONS DO NOT EXPAND THE TERMS OF FAIRCHILD'S WORLDWIDE TERMS AND CONDITIONS, SPECIFICALLY THE WARRANTY THEREIN, WHICH COVERS THESE PRODUCTS.

LIFE SUPPORT POLICY

FAIRCHILD'S PRODUCTS ARE NOT AUTHORIZED FOR USE AS CRITICAL COMPONENTS IN LIFE SUPPORT DEVICES OR SYSTEMS WITHOUT THE EXPRESS WRITTEN APPROVAL OF FAIRCHILD SEMICONDUCTOR CORPORATION.

As used herein:

1. Life support devices or systems are devices or systems which, (a) are intended for surgical implant into the body, or (b) support or sustain life, or (c) whose failure to perform when properly used in accordance with instructions for use provided in the labeling, can be reasonably expected to result in significant injury to the user.
2. A critical component is any component of a life support device or system whose failure to perform can be reasonably expected to cause the failure of the life support device or system, or to affect its safety or effectiveness.

PRODUCT STATUS DEFINITIONS



Definition of Terms

| Datasheet Identification | Product Status | Definition |
|--------------------------|------------------------|---|
| Advance Information | Formative or In Design | This datasheet contains the design specifications for product development. Specifications may change in any manner without notice. |
| Preliminary | First Production | This datasheet contains preliminary data, and supplementary data will be published at a later date. Fairchild Semiconductor reserves the right to make changes at any time without notice in order to improve design. |
| No Identification Needed | Full Production | This datasheet contains final specifications. Fairchild Semiconductor reserves the right to make changes at any time without notice in order to improve design. |
| Obsolete | Not In Production | This datasheet contains specifications on a product that has been discontinued by Fairchild semiconductor. The datasheet is printed for reference information only. |

Rev. I19

Looking for pricing, stock, or lifecycle information?

Click below to explore more details on WIN SOURCE:

-  [View FOD617DSD on WIN SOURCE](#)
-  [Fairchild/ON Semiconductor Information](#)

Optimize Your Supply Chain with WIN SOURCE Solutions

-  Global Sourcing Solution
-  Obsolete Management
-  Cost Control Management
-  Shortage Management
-  Alternative Solution
-  Excess Inventory Management