



**THE DATASHEET OF  
LTC3406AIS5#TRMPBF**



# 1.5MHz, 600mA Synchronous Step-Down Regulator in ThinSOT

## FEATURES

- **High Efficiency: Up to 96%**
- **Very Low Quiescent Current: Only 20 $\mu$ A**
- **Low Output Ripple Voltage During Burst Mode<sup>®</sup> Operation**
- **600mA Output Current**
- **2.5V to 5.5V Input Voltage Range**
- **1.5MHz Constant Frequency Operation**
- **No Schottky Diode Required**
- **Low Dropout Operation: 100% Duty Cycle**
- $\pm 2\%$  0.6V Reference
- Shutdown Mode Draw  $\leq 1\mu$ A Supply Current
- Internal Soft-Start Limits Inrush Current
- Current Mode Operation for Excellent Line and Load Transient Response
- Overtemperature Protected
- Low Profile (1mm) ThinSOT<sup>™</sup> Package

## APPLICATIONS

- Cellular Telephones
- Wireless and DSL Modems
- Digital Still Cameras
- Media Players
- Portable Instruments
- Point of Load Regulation

## DESCRIPTION

The LTC<sup>®</sup>3406A is a high efficiency monolithic synchronous buck regulator using a constant frequency, current mode architecture. Supply current during operation is only 20 $\mu$ A, dropping to  $\leq 1\mu$ A in shutdown. The 2.5V to 5.5V input voltage range makes the LTC3406A ideally suited for single Li-Ion battery-powered applications. 100% duty cycle provides low dropout operation, extending battery runtime portable systems. Automatic Burst Mode operation increases efficiency at light loads, further extending battery runtime.

Switching frequency is internally set at 1.5MHz, allowing the use of small surface mount inductors and capacitors. The internal synchronous switch increases efficiency and eliminates the need for an external Schottky diode. Low output voltages are easily supported with the 0.6V feedback reference voltage. The LTC3406A is available in a low profile (1mm) ThinSOT package.

LT, LTC and LTM are registered trademarks of Linear Technology Corporation. ThinSOT is a registered trademark of Linear Technology Corporation. All other trademarks are the property of their respective owners. Protected by U.S. Patents including 5481178, 6580258.

## TYPICAL APPLICATION

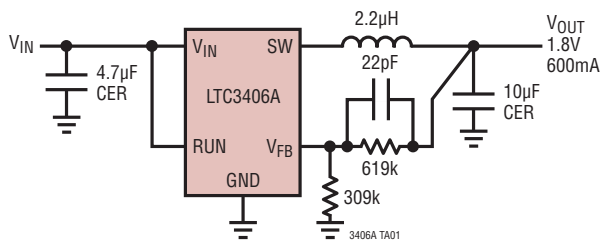

Efficiency vs Load Current

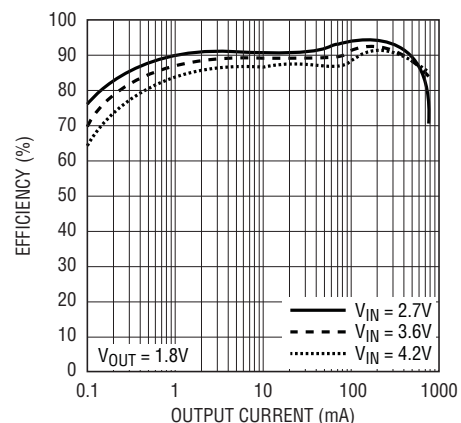

3406A TA01b

# LTC3406A

## ABSOLUTE MAXIMUM RATINGS

(Note 1)

Input Supply Voltage.....	-0.3V to 6V
RUN, V <sub>FB</sub> Voltages .....	-0.3V to V <sub>IN</sub>
SW Voltage (DC) .....	-0.3V to (V <sub>IN</sub> + 0.3V)
P-Channel Switch Source Current (DC) (Note 7).....	800mA
N-Channel Switch Sink Current (DC) (Note 7) .....	800mA
Peak SW Sink and Source Current (Note 7) .....	1.3A
Operating Temperature Range (Note 2) LTC3406AE .....	-40°C to 85°C
LTC3406AI .....	-40°C to 125°C
Junction Temperature (Notes 3, 6).....	125°C
Storage Temperature Range.....	-65°C to 150°C
Lead Temperature (Soldering, 10 sec) .....	300°C

## PIN CONFIGURATION

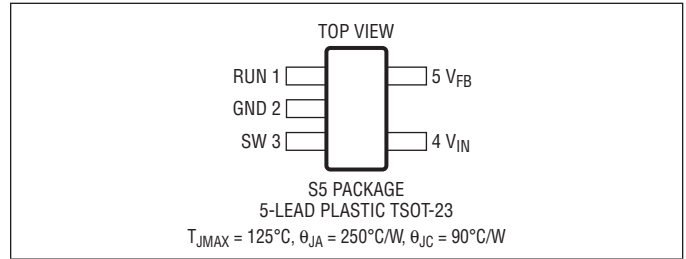

## ORDER INFORMATION

LEAD FREE FINISH	TAPE AND REEL	PART MARKING*	PACKAGE DESCRIPTION	TEMPERATURE RANGE
LTC3406AES5#PBF	LTC3406AES5#TRPBF	LTCWJ	5-Lead Plastic TSOT-23	-40°C to 85°C
LTC3406AIS5#PBF	LTC3406AIS5#TRPBF	LTCWJ	5-Lead Plastic TSOT-23	-40°C to 125°C

Consult LTC Marketing for parts specified with wider operating temperature ranges. \*Temperature grades are identified by a label on the shipping container. Consult LTC Marketing for information on non-standard lead based finish parts.

For more information on lead free part marking, go to: <http://www.linear.com/leadfree/>

For more information on tape and reel specifications, go to: <http://www.linear.com/tapeandree/>

## ELECTRICAL CHARACTERISTICS

The ● denotes the specifications which apply over the full operating temperature range, otherwise specifications are at T<sub>A</sub> = 25°C. V<sub>IN</sub> = 3.6V unless otherwise specified.

SYMBOL	PARAMETER	CONDITIONS	MIN	TYP	MAX	UNITS
I <sub>VFB</sub>	Feedback Current				±30	nA
V <sub>FB</sub>	Regulated Feedback Voltage	(Note 4) LTC3406AE (Note 4) LTC3406AI	0.5880 0.585	0.6 0.6	0.6120 0.615	V V
ΔV <sub>FB</sub>	Reference Voltage Line Regulation	V <sub>IN</sub> = 2.5V to 5.5V (Note 4) LTC3406AE V <sub>IN</sub> = 2.5V to 5.5V (Note 4) LTC3406AI		0.04 0.04	0.4 0.6	%/V %/V
I <sub>PK</sub>	Peak Inductor Current	V <sub>IN</sub> = 3V, V <sub>FB</sub> = 0.5V Duty Cycle < 35%	0.75	1	1.25	A
V <sub>LOADREG</sub>	Output Voltage Load Regulation			0.5		%
V <sub>IN</sub>	Input Voltage Range		2.5		5.5	V
I <sub>S</sub>	Input DC Bias Current	(Note 5) V <sub>FB</sub> = 0V V <sub>FB</sub> = 0.63V V <sub>RUN</sub> = 0V, V <sub>IN</sub> = 5.5V		200 16 0.1	300 30 1	μA μA μA
f <sub>OSC</sub>	Oscillator Frequency	V <sub>FB</sub> = 0.6V	1.2	1.5	1.8	MHz
R <sub>PFET</sub>	R <sub>DS(ON)</sub> of P-Channel FET	I <sub>SW</sub> = 100mA		0.23	0.35	Ω

3406afa

## ELECTRICAL CHARACTERISTICS

The ● denotes the specifications which apply over the full operating temperature range, otherwise specifications are at  $T_A = 25^\circ\text{C}$ .  $V_{IN} = 3.6\text{V}$  unless otherwise specified.

SYMBOL	PARAMETER	CONDITIONS	MIN	TYP	MAX	UNITS
$R_{NFET}$	$R_{DS(ON)}$ of N-Channel FET	$I_{SW} = -100\text{mA}$		0.21	0.35	$\Omega$
$I_{LSW}$	SW Leakage	$V_{RUN} = 0\text{V}$ , $V_{SW} = 0\text{V}$ or $5\text{V}$ , $V_{IN} = 5\text{V}$		$\pm 0.01$	$\pm 1$	$\mu\text{A}$
$t_{SOFT-START}$	Soft-Start Time	$V_{FB}$ from 10% to 90% Full-Scale	0.6	0.9	1.2	ms
$V_{RUN}$	RUN Threshold		● 0.3	1	1.5	V
$I_{RUN}$	RUN Leakage Current			● $\pm 0.01$	$\pm 1$	$\mu\text{A}$

**Note 1:** Stresses beyond those listed under Absolute Maximum Ratings may cause permanent damage to the device. Exposure to any Absolute Maximum Rating condition for extended periods may affect device reliability and lifetime.

**Note 2:** The LTC3406AE is guaranteed to meet performance specifications from  $0^\circ\text{C}$  to  $85^\circ\text{C}$ . Specifications over the  $-40^\circ\text{C}$  to  $85^\circ\text{C}$  operating temperature range are assured by design, characterization and correlation with statistical process controls. The LTC3406AI is guaranteed to meet the specified performance over the full  $-40^\circ\text{C}$  to  $125^\circ\text{C}$  operating temperature range.

**Note 3:**  $T_J$  is calculated from the ambient temperature  $T_A$  and power dissipation  $P_D$  according to the following formula:

$$T_{JC3406A}: T_J = T_A + (P_D)(250^\circ\text{C}/\text{W})$$

**Note 4:** The LTC3406A is tested in a proprietary test mode that connects  $V_{FB}$  to the output of the error amplifier.

**Note 5:** Dynamic supply current is higher due to the gate charge being delivered at the switching frequency.

**Note 6:** This IC includes overtemperature protection that is intended to protect the device during momentary overload conditions. Junction temperature will exceed  $125^\circ\text{C}$  when overtemperature protection is active. Continuous operation above the specified maximum operating junction temperature may impair device reliability.

**Note 7:** Limited by long term current density considerations.

## TYPICAL PERFORMANCE CHARACTERISTICS

(From Front Page Figure Except for the Resistive Divider Resistor Values)

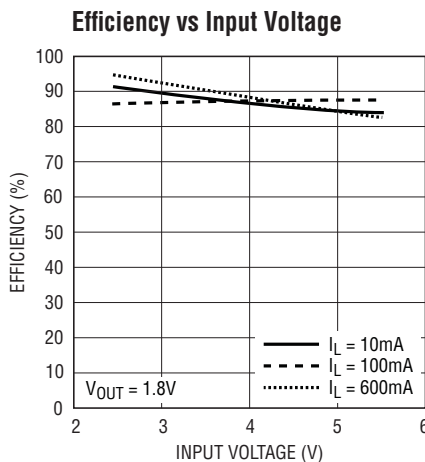

3406A G01

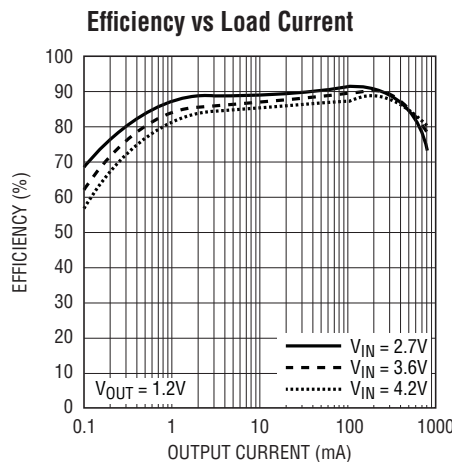

3406A G02

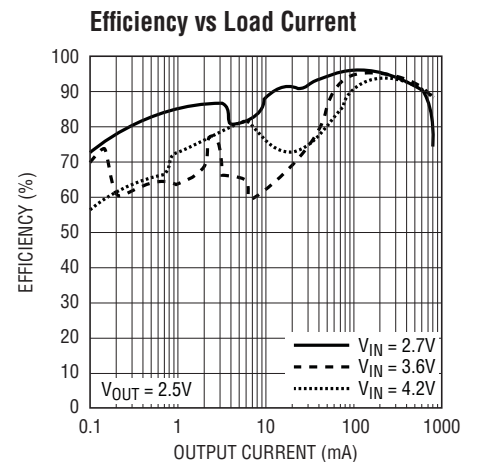

3406A G03

## TYPICAL PERFORMANCE CHARACTERISTICS

(From Front Page Figure Except for the Resistive Divider Resistor Values)

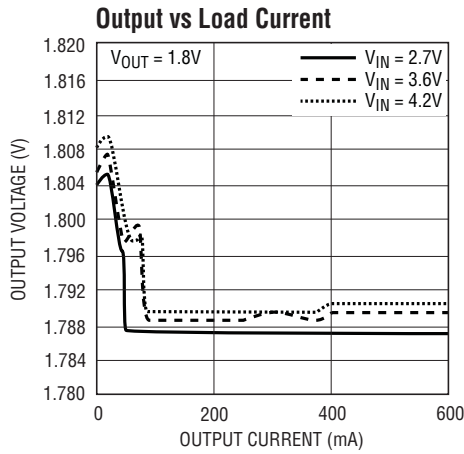

3406A G04

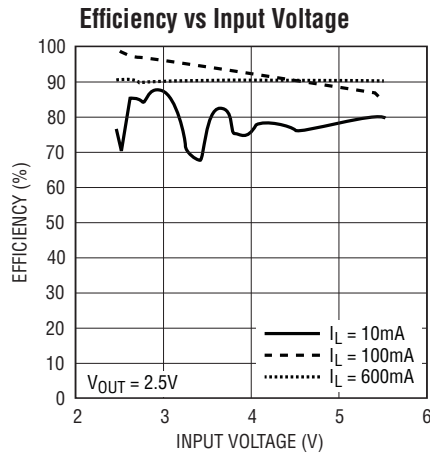

3406A G05

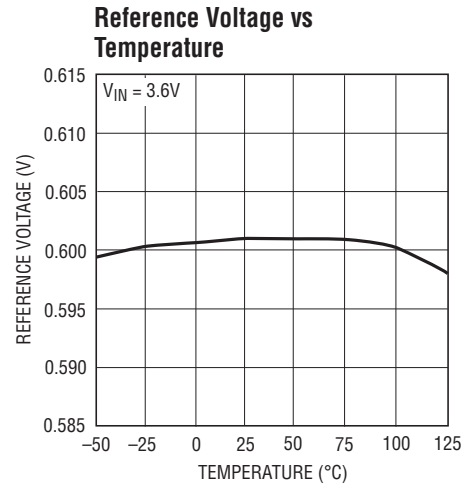

3406A G06

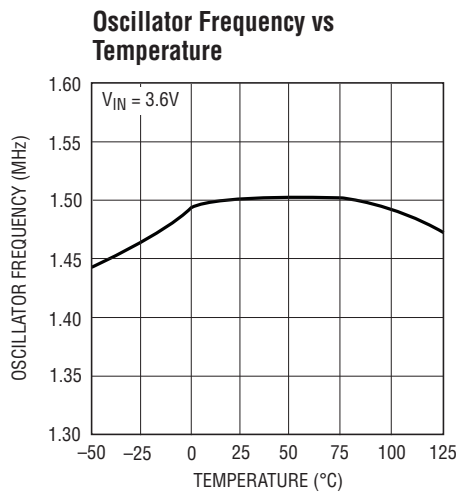

3406A G07

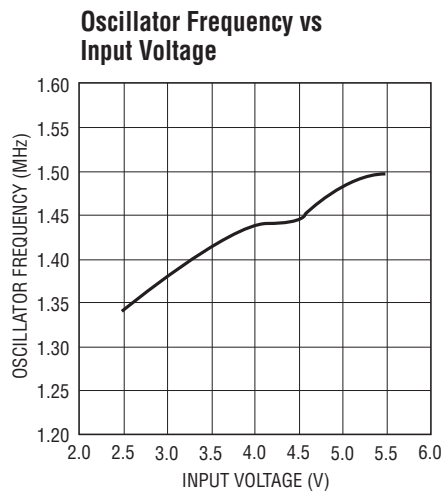

3406A G08

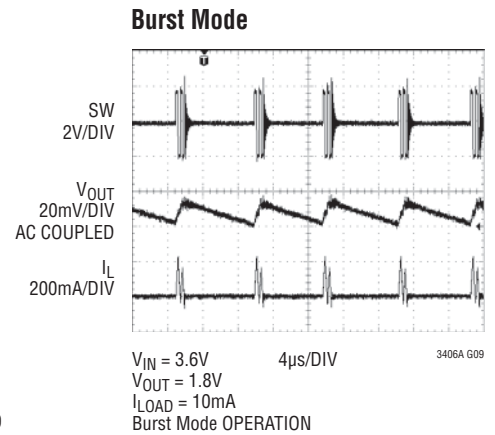

3406A G09

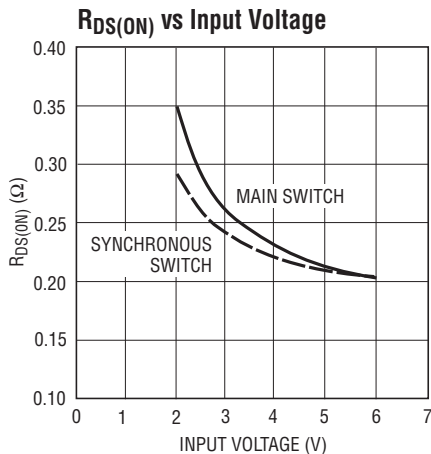

3406A G10

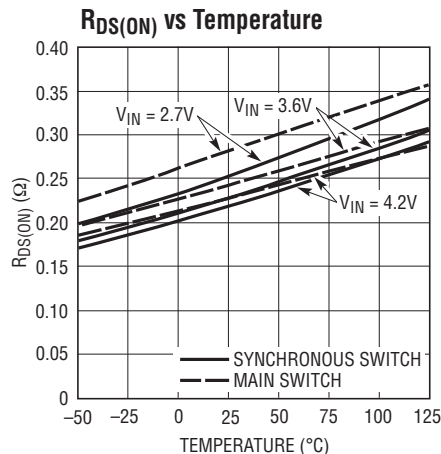

3406A G11

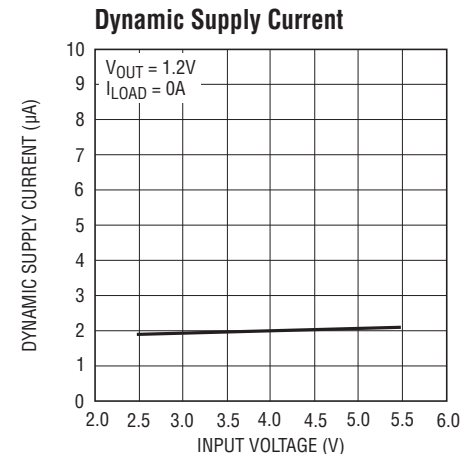

3406A G12

# TYPICAL PERFORMANCE CHARACTERISTICS

(From Front Page Figure Except for the Resistive Divider Resistor Values)

**Dynamic Supply Current vs Temperature**

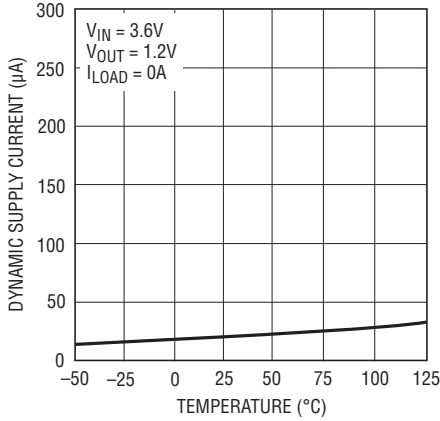

3406A G13

**Switch Leakage vs Temperature**

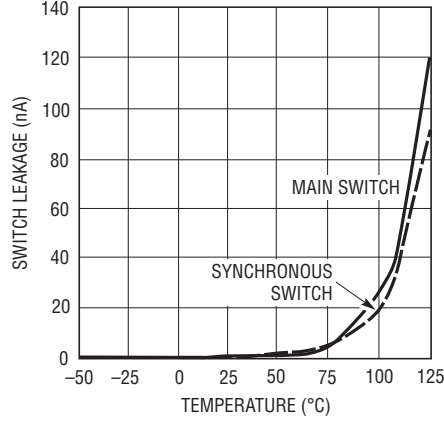

3406A G14

**Switch Leakage vs Input Voltage**

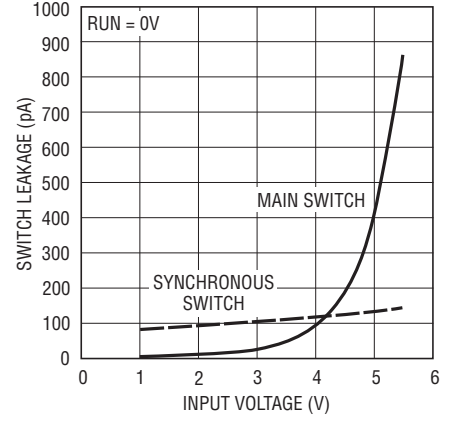

3406A G15

**Start-Up from Shutdown**

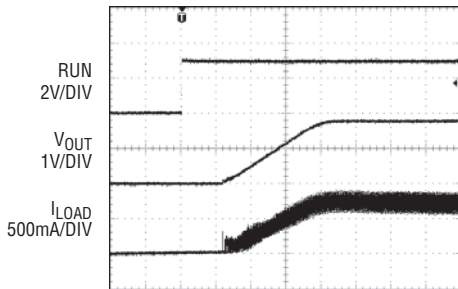

$V_{IN} = 3.6V$   
 $V_{OUT} = 1.8V$   
 $I_{LOAD} = 600mA$  (3Ω RES)

3406A G16

**Load Step**

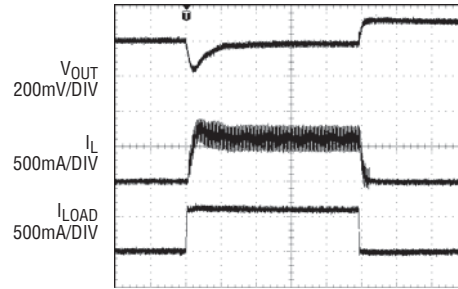

$V_{IN} = 3.6V$   
 $V_{OUT} = 1.8V$   
 $I_{LOAD} = 0mA$  TO 600mA

3406A G17

**Load Step**

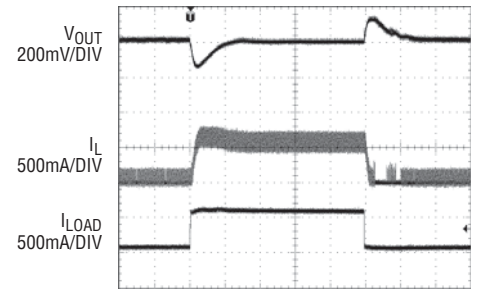

$V_{IN} = 3.6V$   
 $V_{OUT} = 1.8V$   
 $I_{LOAD} = 50mA$  TO 600mA

3406A G18

**Load Step**

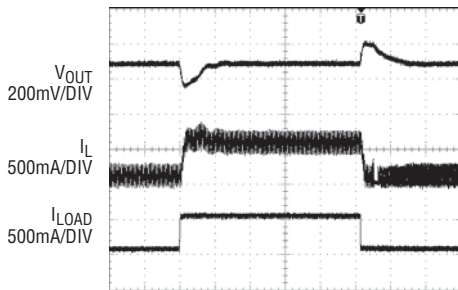

$V_{IN} = 3.6V$   
 $V_{OUT} = 1.8V$   
 $I_{LOAD} = 100mA$  TO 600mA

3406A G19

**Load Step**

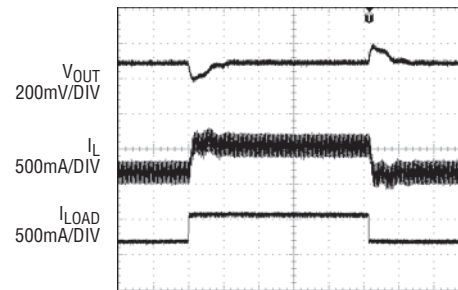

$V_{IN} = 3.6V$   
 $V_{OUT} = 1.8V$   
 $I_{LOAD} = 200mA$  TO 600mA

3406A G20

**Discontinuous Operation**

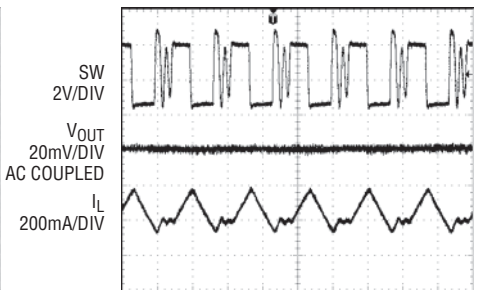

$V_{IN} = 3.6V$   
 $V_{OUT} = 1.8V$   
 $I_{LOAD} = 50mA$

3406A G21

## PIN FUNCTIONS

**RUN (Pin 1):** Run Control Input. Forcing this pin above 1.5V enables the part. Forcing this pin below 0.3V shuts down the device. In shutdown, all functions are disabled drawing  $<1\mu\text{A}$  supply current. Do not leave RUN floating.

**GND (Pin 2):** Ground Pin.

**SW (Pin 3):** Switch Node Connection to Inductor. This pin connects to the drains of the internal main and synchronous power MOSFET switches.

**$V_{\text{IN}}$  (Pin 4):** Main Supply Pin. Must be closely decoupled to GND, Pin 2, with a  $2.2\mu\text{F}$  or greater ceramic capacitor.

**$V_{\text{FB}}$  (Pin 5):** Feedback Pin. Receives the feedback voltage from an external resistive divider across the output.

## FUNCTIONAL DIAGRAM

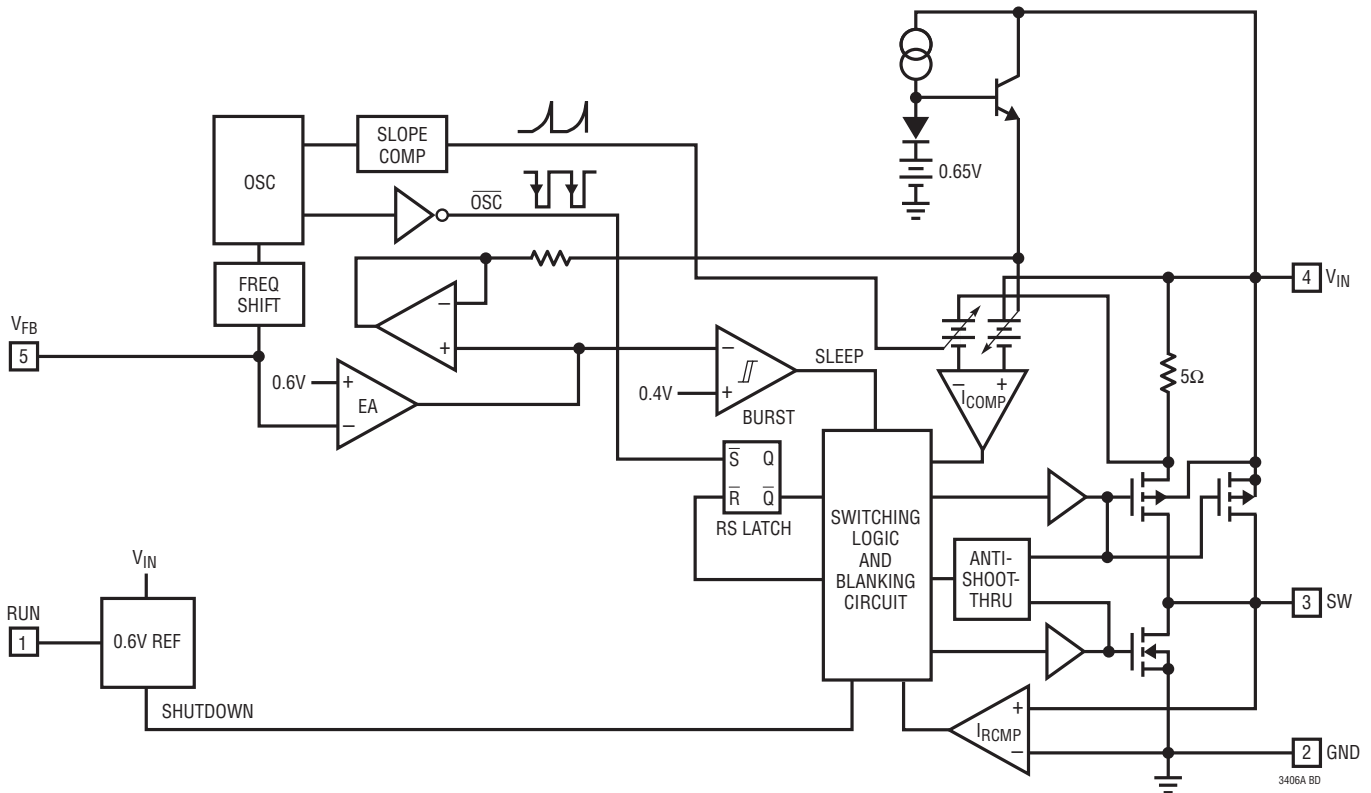

3406A BD

## OPERATION (Refer to Functional Diagram)

### Main Control Loop

The LTC3406A uses a constant frequency, current mode step-down architecture. Both the main (P-channel MOSFET) and synchronous (N-channel MOSFET) switches are internal. During normal operation, the internal top power MOSFET is turned on each cycle when the oscillator sets the RS latch, and turned off when the current comparator,  $I_{COMP}$  resets the RS latch. The peak inductor current at which  $I_{COMP}$  resets the RS latch, is controlled by the output of error amplifier EA. When the load current increases, it causes a slight decrease in the feedback voltage, FB, relative to the 0.6V reference, which in turn, causes the EA amplifier's output voltage to increase until the average inductor current matches the new load current. While the top MOSFET is off, the bottom MOSFET is turned on until either the inductor current starts to reverse, as indicated by the current reversal comparator  $I_{RCMP}$  or the beginning of the next clock cycle.

The main control loop is shut down by grounding RUN, resetting the internal soft-start. Re-enabling the main control loop by pulling RUN high activates the internal soft-start, which slowly ramps the output voltage over approximately 0.9ms until it reaches regulation.

### Burst Mode Operation

The LTC3406A is capable of Burst Mode operation in which the internal power MOSFETs operate intermittently based on load demand.

In Burst Mode operation, the peak current of the inductor is set to approximately 100mA regardless of the output load. Each burst event can last from a few cycles at light loads to almost continuously cycling with short sleep intervals at moderate loads. In between these burst events, the power MOSFETs and any unneeded circuitry are turned

off, reducing the quiescent current to 20 $\mu$ A. In this sleep state, the load current is being supplied solely from the output capacitor. As the output voltage droops, the EA amplifier's output rises above the sleep threshold signaling the BURST comparator to trip and turn the top MOSFET on. This process repeats at a rate that is dependent on the load demand.

### Dropout Operation

As the input supply voltage decreases to a value approaching the output voltage, the duty cycle increases toward the maximum on-time. Further reduction of the supply voltage forces the main switch to remain on for more than one cycle until it reaches 100% duty cycle. The output voltage will then be determined by the input voltage minus the voltage drop across the P-channel MOSFET and the inductor.

An important detail to remember is that at low input supply voltages, the  $R_{DS(ON)}$  of the P-channel switch increases (see Typical Performance Characteristics). Therefore, the user should calculate the power dissipation when the LTC3406A is used at 100% duty cycle with low input voltage (See Thermal Considerations in the Applications Information section).

### Slope Compensation and Inductor Peak Current

Slope compensation provides stability in constant frequency architectures by preventing subharmonic oscillations at high duty cycles. It is accomplished internally by adding a compensating ramp to the inductor current signal at duty cycles in excess of 40%. Normally, this results in a reduction of maximum inductor peak current for duty cycles >40%. However, the LTC3406A uses a patented scheme that counteracts this compensating ramp, which allows the maximum inductor peak current to remain unaffected throughout all duty cycles.

## APPLICATIONS INFORMATION

The basic LTC3406A application circuit is shown on the front page. External component selection is driven by the load requirement and begins with the selection of L followed by  $C_{IN}$  and  $C_{OUT}$ .

### Inductor Selection

For most applications, the value of the inductor will fall in the range of  $1\mu\text{H}$  to  $4.7\mu\text{H}$ . Its value is chosen based on the desired ripple current. Large value inductors lower ripple current and small value inductors result in higher ripple currents. Higher  $V_{IN}$  or  $V_{OUT}$  also increases the ripple current as shown in Equation 1. A reasonable starting point for setting ripple current is  $\Delta I_L = 240\text{mA}$  (40% of 600mA).

$$\Delta I_L = \frac{1}{(f)(L)} V_{OUT} \left( 1 - \frac{V_{OUT}}{V_{IN}} \right) \quad (1)$$

The DC current rating of the inductor should be at least equal to the maximum load current plus half the ripple current to prevent core saturation. Thus, a 720mA rated inductor should be enough for most applications (600mA + 120mA). For better efficiency, choose a low DC-resistance inductor.

The inductor value also has an effect on Burst Mode operation. The transition to low current operation begins when the inductor current peaks fall to approximately 100mA. Lower inductor values (higher  $\Delta I_L$ ) will cause this to occur at lower load currents, which can cause a dip in efficiency in the upper range of low current operation. In Burst Mode operation, lower inductance values will cause the burst frequency to increase.

### Inductor Core Selection

Different core materials and shapes will change the size/current and price/current relationship of an inductor. Toroid or shielded pot cores in ferrite or permalloy materials are small and don't radiate much energy, but generally cost more than powdered iron core inductors with similar electrical characteristics. The choice of which

**Table 1. Representative Surface Mount Inductors**

PART NUMBER	VALUE ( $\mu\text{H}$ )	DCR ( $\Omega$ MAX)	MAX DC CURRENT (A)	SIZE $W \times L \times H$ ( $\text{mm}^3$ )
Sumida CDRH3D16	1.5	0.043	1.55	3.8 × 3.8 × 1.8
	2.2	0.075	1.20	
	3.3	0.110	1.10	
	4.7	0.162	0.90	
Sumida CMD4D06	2.2	0.116	0.950	3.5 × 4.3 × 0.8
	3.3	0.174	0.770	
	4.7	0.216	0.750	
Panasonic ELT5KT	3.3	0.17	1.00	4.5 × 5.4 × 1.2
	4.7	0.20	0.95	
Murata LQH32CN	1.0	0.060	1.00	2.5 × 3.2 × 2.0
	2.2	0.097	0.79	
	4.7	0.150	0.65	

style inductor to use often depends more on the price vs size requirements and any radiated field/EMI requirements than on what the LTC3406A requires to operate. Table 1 shows some typical surface mount inductors that work well in LTC3406A applications.

### $C_{IN}$ and $C_{OUT}$ Selection

In continuous mode, the source current of the top MOSFET is a square wave of duty cycle  $V_{OUT}/V_{IN}$ . To prevent large voltage transients, a low ESR input capacitor sized for the maximum RMS current must be used. The maximum RMS capacitor current is given by:

$$C_{IN} \text{ required } I_{RMS} \cong I_{OMAX} \frac{[V_{OUT}(V_{IN} - V_{OUT})]^{1/2}}{V_{IN}}$$

This formula has a maximum at  $V_{IN} = 2V_{OUT}$ , where  $I_{RMS} = I_{OUT}/2$ . This simple worst-case condition is commonly used for design because even significant deviations do not offer much relief. Note that the capacitor manufacturer's ripple current ratings are often based on 2000 hours of life. This makes it advisable to further derate the capacitor, or choose a capacitor rated at a higher temperature than required. Always consult the manufacturer if there is any question.

## APPLICATIONS INFORMATION

The selection of  $C_{OUT}$  is driven by the required effective series resistance (ESR).

Typically, once the ESR requirement for  $C_{OUT}$  has been met, the RMS current rating generally far exceeds the  $I_{RIPPLE(P-P)}$  requirement. The output ripple  $\Delta V_{OUT}$  is determined by:

$$\Delta V_{OUT} \cong \Delta I_L \left( ESR + \frac{1}{8fC_{OUT}} \right)$$

where  $f$  = operating frequency,  $C_{OUT}$  = output capacitance and  $\Delta I_L$  = ripple current in the inductor. For a fixed output voltage, the output ripple is highest at maximum input voltage since  $\Delta I_L$  increases with input voltage.

Aluminum electrolytic and dry tantalum capacitors are both available in surface mount configurations. In the case of tantalum, it is critical that the capacitors are surge tested for use in switching power supplies. An excellent choice is the AVX TPS series of surface mount tantalum. These are specially constructed and tested for low ESR so they give the lowest ESR for a given volume. Other capacitor types include Sanyo POSCAP, Kemet T510 and T495 series, and Sprague 593D and 595D series. Consult the manufacturer for other specific recommendations.

### Using Ceramic Input and Output Capacitors

Higher values, lower cost ceramic capacitors are now becoming available in smaller case sizes. Their high ripple current, high voltage rating and low ESR make them ideal for switching regulator applications. Because the LTC3406A's control loop does not depend on the output capacitor's ESR for stable operation, ceramic capacitors can be used freely to achieve very low output ripple and small circuit size.

However, care must be taken when ceramic capacitors are used at the input and the output. When a ceramic capacitor is used at the input and the power is supplied by a wall adapter through long wires, a load step at the output can

induce ringing at the input,  $V_{IN}$ . At best, this ringing can couple to the output and be mistaken as loop instability. At worst, a sudden inrush of current through the long wires can potentially cause a voltage spike at  $V_{IN}$ , large enough to damage the part.

When choosing the input and output ceramic capacitors, choose the X5R or X7R dielectric formulations. These dielectrics have the best temperature and voltage characteristics of all the ceramics for a given value and size.

### Output Voltage Programming

In the adjustable version, the output voltage is set by a resistive divider according to the following formula:

$$V_{OUT} = 0.6V \left( 1 + \frac{R2}{R1} \right) \quad (2)$$

The external resistive divider is connected to the output, allowing remote voltage sensing as shown in Figure 1.

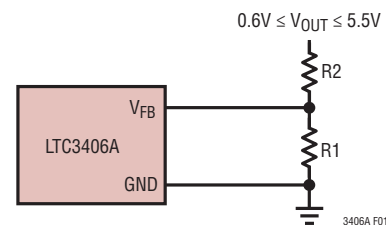

Figure 1. Setting the LTC3406A Output Voltage

### Efficiency Considerations

The efficiency of a switching regulator is equal to the output power divided by the input power times 100%. It is often useful to analyze individual losses to determine what is limiting the efficiency and which change would produce the most improvement. Efficiency can be expressed as:

$$\text{Efficiency} = 100\% - (L1 + L2 + L3 + \dots)$$

where  $L1$ ,  $L2$ , etc. are the individual losses as a percentage of input power.

## APPLICATIONS INFORMATION

Although all dissipative elements in the circuit produce losses, two main sources usually account for most of the losses in LTC3406A circuits:  $V_{IN}$  quiescent current and  $I^2R$  losses. The  $V_{IN}$  quiescent current loss dominates the efficiency loss at very low load currents whereas the  $I^2R$  loss dominates the efficiency loss at medium to high load currents. In a typical efficiency plot, the efficiency curve at very low load currents can be misleading since the actual power lost is of no consequence as illustrated in Figure 2.

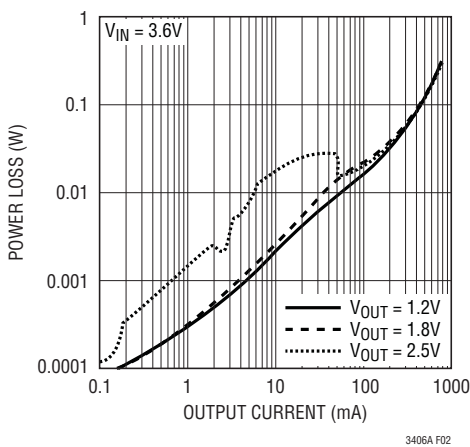

Figure 2. Power Lost vs Load Current

1. The  $V_{IN}$  quiescent current is due to two components: the DC bias current as given in the electrical characteristics and the internal main switch and synchronous switch gate charge currents. The gate charge current results from switching the gate capacitance of the internal power MOSFET switches. Each time the gate is switched from high to low to high again, a packet of charge,  $dQ$ , moves from  $V_{IN}$  to ground. The resulting  $dQ/dt$  is the current out of  $V_{IN}$  that is typically larger than the DC bias current. In continuous mode,  $I_{GATECHG} = f(Q_T + Q_B)$  where  $Q_T$  and  $Q_B$  are the gate charges of the internal top and bottom switches. Both the DC bias and gate charge losses are proportional to  $V_{IN}$  and thus their effects will be more pronounced at higher supply voltages.

2.  $I^2R$  losses are calculated from the resistances of the internal switches,  $R_{SW}$ , and external inductor  $R_L$ . In continuous mode, the average output current flowing through inductor  $L$  is “chopped” between the main switch and the synchronous switch. Thus, the series resistance looking into the SW pin is a function of both top and bottom MOSFET  $R_{DS(ON)}$  and the duty cycle (DC) as follows:

$$R_{SW} = (R_{DS(ON)TOP})(DC) + (R_{DS(ON)BOT})(1 - DC)$$

The  $R_{DS(ON)}$  for both the top and bottom MOSFETs can be obtained from the Typical Performance Characteristics curves. Thus, to obtain  $I^2R$  losses, simply add  $R_{SW}$  to  $R_L$  and multiply the result by the square of the average output current.

Other losses including  $C_{IN}$  and  $C_{OUT}$  ESR dissipative losses and inductor core losses generally account for less than 2% total additional loss.

### Thermal Considerations

In most applications the LTC3406A does not dissipate much heat due to its high efficiency. But, in applications where the LTC3406A is running at high ambient temperature with low supply voltage and high duty cycles, such as in dropout, the heat dissipated may exceed the maximum junction temperature of the part. If the junction temperature reaches approximately 150°C, both power switches will be turned off and the SW node will become high impedance.

To avoid the LTC3406A from exceeding the maximum junction temperature, the user will need to do some thermal analysis. The goal of the thermal analysis is to determine whether the power dissipated exceeds the maximum junction temperature of the part. The temperature rise is given by:

$$T_R = (P_D)(\theta_{JA})$$

where  $P_D$  is the power dissipated by the regulator and  $\theta_{JA}$  is the thermal resistance from the junction of the die to the ambient temperature.

## APPLICATIONS INFORMATION

The junction temperature,  $T_J$ , is given by:

$$T_J = T_A + T_R$$

where  $T_A$  is the ambient temperature.

As an example, consider the LTC3406A in dropout at an input voltage of 2.7V, a load current of 600mA and an ambient temperature of 70°C. From the typical performance graph of switch resistance, the  $R_{DS(ON)}$  of the P-channel switch at 70°C is approximately 0.27Ω. Therefore, power dissipated by the part is:

$$P_D = I_{LOAD}^2 \cdot R_{DS(ON)} = 97.2mW$$

For the SOT-23 package, the  $\theta_{JA}$  is 250°C/W. Thus, the junction temperature of the regulator is:

$$T_J = 70^\circ C + (0.0972)(250) = 94.3^\circ C$$

which is below the maximum junction temperature of 125°C.

Note that at higher supply voltages, the junction temperature is lower due to reduced switch resistance ( $R_{DS(ON)}$ ).

### Checking Transient Response

The regulator loop response can be checked by looking at the load transient response. Switching regulators take several cycles to respond to a step in load current. When a load step occurs,  $V_{OUT}$  immediately shifts by an amount equal to  $(\Delta I_{LOAD} \cdot ESR)$ , where ESR is the effective series resistance of  $C_{OUT}$ .  $\Delta I_{LOAD}$  also begins to charge or discharge  $C_{OUT}$ , which generates a feedback error signal. The regulator loop then acts to return  $V_{OUT}$  to its steady-state value. During this recovery time  $V_{OUT}$  can be monitored for overshoot or ringing that would indicate a stability problem. For a detailed explanation of switching control loop theory, see Application Note 76.

A second, more severe transient is caused by switching in loads with large ( $>1\mu F$ ) supply bypass capacitors. The discharged bypass capacitors are effectively put in parallel with  $C_{OUT}$ , causing a rapid drop in  $V_{OUT}$ . No regulator can deliver enough current to prevent this problem if the load switch resistance is low and it is driven quickly. The only solution is to limit the rise time of the switch drive so that the load rise time is limited to approximately  $(25 \cdot C_{LOAD})$ . Thus, a 10μF capacitor charging to 3.3V would require a 250μs rise time, limiting the charging current to about 130mA.

### PC Board Layout Checklist

When laying out the printed circuit board, the following checklist should be used to ensure proper operation of the LTC3406A. These items are also illustrated graphically in Figures 3 and 4. Check the following in your layout:

1. The power traces, consisting of the GND trace, the SW trace, the  $V_{OUT}$  trace and the  $V_{IN}$  trace should be kept short, direct and wide.
2. Does the  $V_{FB}$  pin connect directly to the feedback resistors? The resistive divider R1/R2 must be connected between the (+) plate of  $C_{OUT}$  and ground.
3. Does  $C_{IN}$  connect to  $V_{IN}$  as closely as possible? This capacitor provides the AC current to the internal power MOSFETs.
4. Keep the switching node, SW, away from the sensitive  $V_{FB}$  node.
5. Keep the (–) plates of  $C_{IN}$  and  $C_{OUT}$ , and the IC ground, as close as possible.

## APPLICATIONS INFORMATION

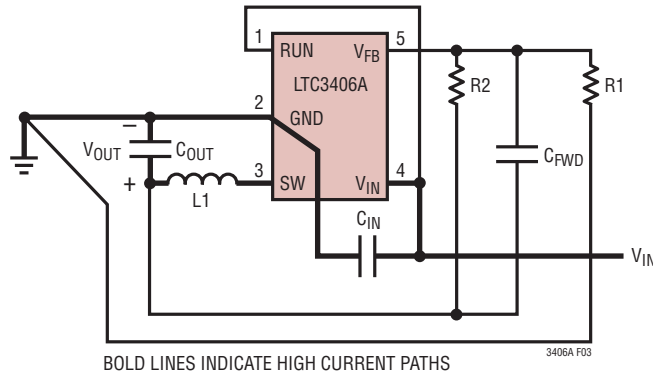

Figure 3. LTC3406A Layout Diagram

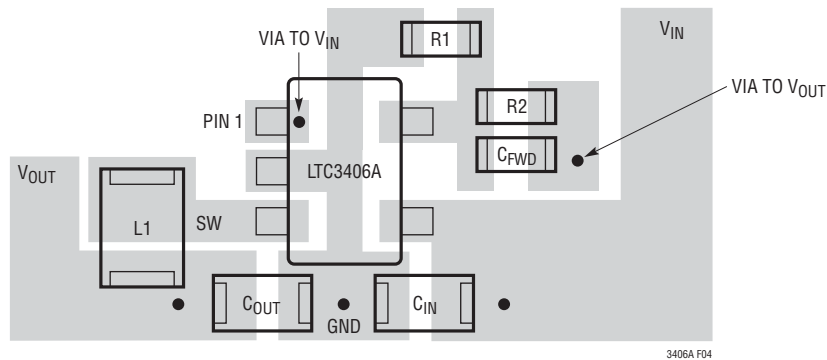

Figure 4. LTC3406A Suggested Layout

### Design Example

As a design example, assume the LTC3406A is used in a single lithium-ion battery-powered cellular phone application. The  $V_{IN}$  will be operating from a maximum of 4.2V down to about 2.7V. The load current requirement is a maximum of 0.6A but most of the time it will be in standby mode, requiring only 2mA. Efficiency at both low and high load currents is important. Output voltage is 2.5V. With this information we can calculate L using Equation (1),

$$L = \frac{1}{(f)(\Delta I_L)} V_{OUT} \left( 1 - \frac{V_{OUT}}{V_{IN}} \right) \quad (3)$$

Substituting  $V_{OUT} = 2.5V$ ,  $V_{IN} = 4.2V$ ,  $\Delta I_L = 240mA$  and  $f = 1.5MHz$  in Equation (3) gives:

$$L = \frac{2.5V}{1.5MHz(240mA)} \left( 1 - \frac{2.5V}{4.2V} \right) = 2.81\mu H$$

A 2.2 $\mu H$  inductor works well for this application. For best efficiency choose a 720mA or greater inductor with less than 0.2 $\Omega$  series resistance.

$C_{IN}$  will require an RMS current rating of at least  $0.3A \cong I_{LOAD(MAX)}/2$  at temperature and  $C_{OUT}$  will require an ESR of less than 0.25 $\Omega$ . In most cases, a ceramic capacitor will satisfy this requirement.

## APPLICATIONS INFORMATION

For the feedback resistors, choose  $R1 = 316k$ .  $R2$  can then be calculated from Equation (2) to be:

$$R2 = \left( \frac{V_{OUT}}{0.6} - 1 \right) R1 = 1000k \quad (4)$$

Figure 5 shows the complete circuit along with its efficiency curve.

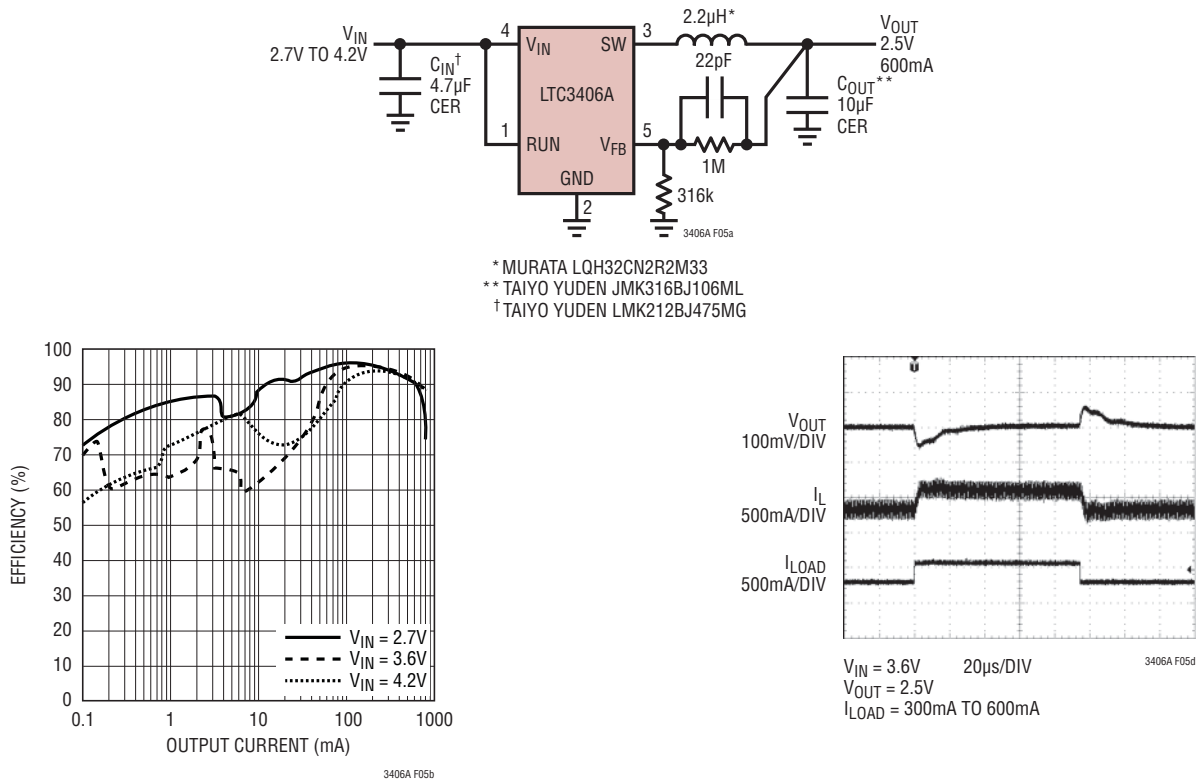
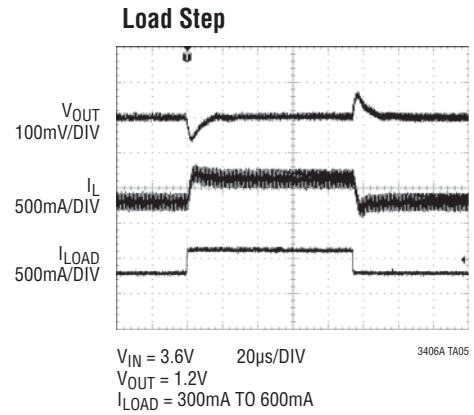
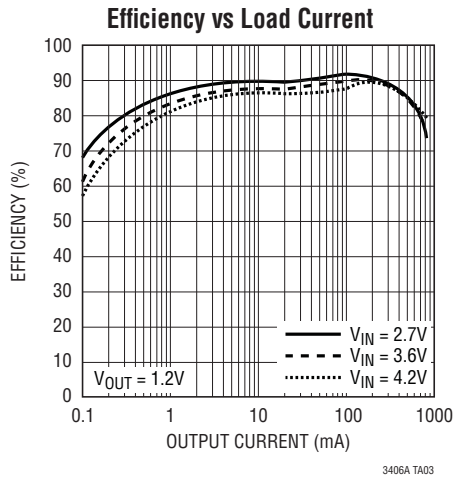
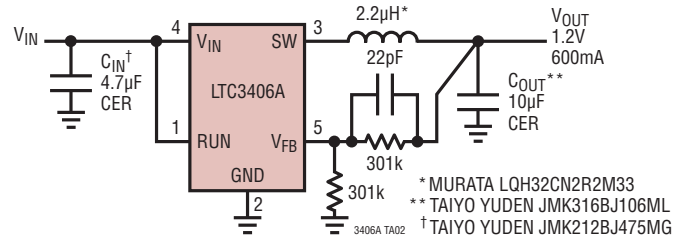

Figure 5.

## TYPICAL APPLICATIONS

### Single Li-Ion 1.2V/600mA Regulator for High Efficiency and Small Footprint



## PACKAGE DESCRIPTION

### S5 Package 5-Lead Plastic TSOT-23 (Reference LTC DWG # 05-08-1635)

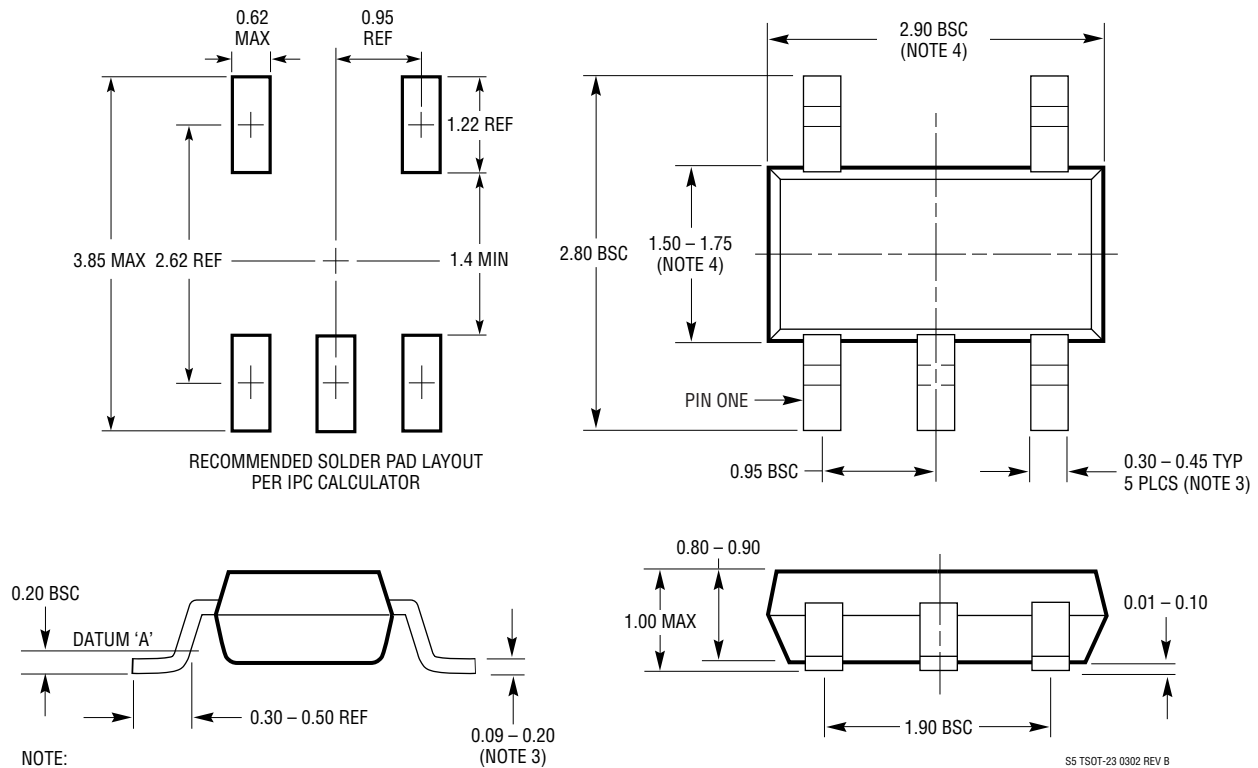

## RELATED PARTS

PART NUMBER	DESCRIPTION	COMMENTS
LTC3406/LTC3406B	600mA ( $I_{OUT}$ ), 1.5MHz, Synchronous Step-Down DC/DC Converters	96% Efficiency, $V_{IN}$ : 2.5V to 5.5V, $V_{OUT(MIN)} = 0.6V$ , $I_Q = 20\mu A$ , $I_{SD} < 1\mu A$ , ThinSOT Package
LTC3407/LTC3407-2	Dual 600mA/800mA ( $I_{OUT}$ ), 1.5MHz/2.25MHz, Synchronous Step-Down DC/DC Converters	95% Efficiency, $V_{IN}$ : 2.5V to 5.5V, $V_{OUT(MIN)} = 0.6V$ , $I_Q = 40\mu A$ , $I_{SD} < 1\mu A$ , MS10E, DFN Packages
LTC3410/LTC3410B	300mA ( $I_{OUT}$ ), 2.25MHz, Synchronous Step-Down DC/DC Converters	95% Efficiency, $V_{IN}$ : 2.5V to 5.5V, $V_{OUT(MIN)} = 0.8V$ , $I_Q = 26\mu A$ , $I_{SD} < 1\mu A$ , SC70 Package
LTC3411	1.25A ( $I_{OUT}$ ), 4MHz, Synchronous Step-Down DC/DC Converter	95% Efficiency, $V_{IN}$ : 2.5V to 5.5V, $V_{OUT(MIN)} = 0.8V$ , $I_Q = 60\mu A$ , $I_{SD} < 1\mu A$ , MS10, DFN Packages
LTC3412	2.5A ( $I_{OUT}$ ), 4MHz, Synchronous Step-Down DC/DC Converter	95% Efficiency, $V_{IN}$ : 2.5V to 5.5V, $V_{OUT(MIN)} = 0.8V$ , $I_Q = 60\mu A$ , $I_{SD} < 1\mu A$ , TSSOP-16E Package
LTC3440	600mA ( $I_{OUT}$ ), 2MHz, Synchronous Buck-Boost DC/DC Converter	95% Efficiency, $V_{IN}$ : 2.5V to 5.5V, $V_{OUT(MIN)}$ : 2.5V to 5.5V, $I_Q = 25\mu A$ , $I_{SD} < 1\mu A$ , MS10, DFN Packages
LTC3530	600mA ( $I_{OUT}$ ), 2MHz, Synchronous Buck-Boost DC/DC Converter	95% Efficiency, $V_{IN}$ : 1.8V to 5.5V, $V_{OUT(MIN)}$ : 1.8V to 5.25V, $I_Q = 40\mu A$ , $I_{SD} < 1\mu A$ , MS10, DFN Packages
LTC3531/LTC3531-3/ LTC3531-3.3	200mA ( $I_{OUT}$ ), 1.5MHz, Synchronous Buck-Boost DC/DC Converters	95% Efficiency, $V_{IN}$ : 1.8V to 5.5V, $V_{OUT(MIN)}$ : 2V to 5V, $I_Q = 16\mu A$ , $I_{SD} < 1\mu A$ , ThinSOT, DFN Packages
LTC3532	500mA ( $I_{OUT}$ ), 2MHz, Synchronous Buck-Boost DC/DC Converter	95% Efficiency, $V_{IN}$ : 2.4V to 5.5V, $V_{OUT(MIN)}$ : 2.4V to 5.25V, $I_Q = 35\mu A$ , $I_{SD} < 1\mu A$ , MS10, DFN Packages
LTC3542	500mA ( $I_{OUT}$ ), 2.25MHz, Synchronous Step-Down DC/DC Converter	95% Efficiency, $V_{IN}$ : 2.5V to 5.5V, $V_{OUT(MIN)} = 0.6V$ , $I_Q = 26\mu A$ , $I_{SD} < 1\mu A$ , 2mm $\times$ 2mm DFN Package
LTC3544/LTC3544B	Quad 300mA + 2 $\times$ 200mA + 100mA, 2.25MHz, Synchronous Step-Down DC/DC Converters	95% Efficiency, $V_{IN}$ : 2.5V to 5.5V, $V_{OUT(MIN)} = 0.8V$ , $I_Q = 70\mu A$ , $I_{SD} < 1\mu A$ , 3mm $\times$ 3mm QFN Package
LTC3547/LTC3547B	Dual 300mA, 2.25MHz, Synchronous Step-Down DC/DC Converters	96% Efficiency, $V_{IN}$ : 2.5V to 5.5V, $V_{OUT(MIN)} = 0.6V$ , $I_Q = 40\mu A$ , $I_{SD} < 1\mu A$ , 2mm $\times$ 3mm DFN Package
LTC3548/LTC3548-1/ LTC3548-2	Dual 400mA/800mA ( $I_{OUT}$ ), 2.25MHz, Synchronous Step-Down DC/DC Converters	95% Efficiency, $V_{IN}$ : 2.5V to 5.5V, $V_{OUT(MIN)} = 0.6V$ , $I_Q = 40\mu A$ , $I_{SD} < 1\mu A$ , MS10E, DFN Packages
LTC3560	800mA ( $I_{OUT}$ ), 2.25MHz, Synchronous Step-Down DC/DC Converter	95% Efficiency, $V_{IN}$ : 2.5V to 5.5V, $V_{OUT(MIN)} = 0.6V$ , $I_Q = 16\mu A$ , $I_{SD} < 1\mu A$ , ThinSOT Package
LTC3561	1.25A ( $I_{OUT}$ ), 4MHz, Synchronous Step-Down DC/DC Converter	95% Efficiency, $V_{IN}$ : 2.5V to 5.5V, $V_{OUT(MIN)} = 0.8V$ , $I_Q = 240\mu A$ , $I_{SD} < 1\mu A$ , DFN Package

## Looking for pricing, stock, or lifecycle information?

Click below to explore more details on WIN SOURCE:

 [View LTC3406AIS5#TRMPBF on WIN SOURCE](#)

 [Linear Technology](#) Information

## Optimize Your Supply Chain with WIN SOURCE Solutions

-  Global Sourcing Solution
-  Obsolete Management
-  Cost Control Management
-  Shortage Management
-  Alternative Solution
-  Excess Inventory Management