



# THE DATASHEET OF SM4T33CAY





### Complies with the following standards

- ISO 10605, C = 150 pF, R = 330 Ω:
  - 30 kV (air discharge)
  - 30 kV (contact discharge)
- ISO 10605, C = 330 pF, R = 330 Ω:
  - 30 kV (air discharge)
  - 30 kV (contact discharge)
- ISO 7637-2<sup>(a)</sup>
  - pulse 1:  $V_S = -100\text{ V}$
  - pulse 2a:  $V_S = +50\text{ V}$
  - pulse 3a:  $V_S = -150\text{ V}$
  - pulse 3b:  $V_S = +100\text{ V}$

### Features

- Peak pulse power:
  - 400 W (10/1000 μs)
  - 2.3 kW (8/20 μs)
- Stand-off voltage range: from 5 V to 70 V
- Unidirectional and bidirectional types
- Low leakage current:
  - 0.2 μA at 25 °C
  - 1 μA at 85 °C
- Operating  $T_{j\text{max}}$ : 150 °C
- High power capability at  $T_{j\text{max}}$ :
  - 270 W (10/1000 μs)
- JEDEC registered package outline
- Resin meets UL 94, V0
- AEC-Q101 qualified

### Description

The SM4TY Transil series has been designed to protect sensitive automotive circuits against surges defined in ISO 7637-2 and against electrostatic discharges according to ISO 10605.

The planar technology makes it compatible with high-end circuits where low leakage current and high junction temperature are required to provide reliability and stability over time. SM4TY devices are packaged in SMA (SMA footprint in accordance with IPC 7531 standard).

**TM:** Transil is a trademark of STMicroelectronics

a. Not applicable to parts with stand-off voltage lower than the average battery voltage (13.5 V)

# 1 Characteristics

Table 1. Absolute maximum ratings ( $T_{amb} = 25\text{ }^{\circ}\text{C}$ )

| Symbol    | Parameter   |   | Value        | Unit               |
|-----------|---|---|--------------|--------------------|
| $V_{PP}$  | Peak pulse voltage                                  | ISO 10605 (C = 150 pF, R = 330 $\Omega$ ) |              | kV                 |
|           |   | Contact discharge                         | 30           |                    |
|           |   | Air discharge                             | 30           |                    |
|           |   | ISO 10605, C = 330 pF, R = 330 $\Omega$ : |              |                    |
|           |   | Contact discharge                         | 30           |                    |
|           |   | Air discharge                             | 30           |                    |
| PPP       | Peak pulse power dissipation <sup>(1)</sup>         | $T_{j\text{ initial}} = T_{amb}$          | 400          | W                  |
| $T_{stg}$ | Storage temperature range                           |   | -65 to + 150 | $^{\circ}\text{C}$ |
| $T_j$     | Operating junction temperature range                |   | -55 to + 150 | $^{\circ}\text{C}$ |
| $T_L$     | Maximum lead temperature for soldering during 10 s. |   | 260          | $^{\circ}\text{C}$ |

1. For a surge greater than the maximum values, the diode will fail in short-circuit.

Figure 1. Electrical characteristics - definitions



Figure 2. Pulse definition for electrical characteristics



Table 2. Electrical characteristics, typical values if not otherwise stated ( $T_{amb} = 25\text{ °C}$ )

| Order code    | $I_{RM} \text{ max @ } V_{RM}$ |       | $V_{BR} \text{ @ } I_R^{(1)}$ |      |      |      | $V_{CL} \text{ @ } I_{PP} \text{ 10/1000 } \mu\text{s}$ |                  | $R_D \text{ 10/1000 } \mu\text{s}$ | $V_{CL} \text{ @ } I_{PP} \text{ 8/20 } \mu\text{s}$ |                  | $R_D \text{ 8/20 } \mu\text{s}$ | $\alpha T^{(2)}$ |      |
|---------------|--------------------------------|-------|-------------------------------|------|------|------|---|------------------|------------------------------------|--|------------------|---------------------------------|------------------|------|
|               | 25 °C                          | 85 °C | min.                          | typ. | max. | max. |   |                  | max.                               |  |                  | max                             |                  |      |
|               | $\mu\text{A}$                  | V     | V                             |      |      | mA   | V <sup>(3)</sup>  | A <sup>(4)</sup> | $\Omega$                           | V <sup>(3)</sup>                                     | A <sup>(4)</sup> | $\Omega$                        | 10-4/<br>°C      |      |
| SM4T6V7AY/CAY | 20                             | 50    | 5                             | 6.4  | 6.74 | 7.1  | 10  | 9.2              | 43.5                               | 0.049  | 13.4             | 174                             | 0.036            | 5.7  |
| SM4T7V6AY/CAY | 20                             | 50    | 6.5                           | 7.2  | 7.58 | 8.0  | 10  | 11.2             | 35.7                               | 0.091  | 14.5             | 160                             | 0.041            | 6.1  |
| SM4T10AY/CAY  | 20                             | 50    | 8.5                           | 9.4  | 9.9  | 10.4 | 1   | 14.4             | 27.7                               | 0.145  | 19.5             | 124                             | 0.073            | 7.3  |
| SM4T12AY/CAY  | 0.2                            | 1     | 10                            | 11.1 | 11.7 | 12.3 | 1   | 17.0             | 23.5                               | 0.201  | 21.7             | 106                             | 0.089            | 7.8  |
| SM4T14AY/CAY  | 0.2                            | 1     | 12                            | 13.3 | 14.0 | 14.7 | 1   | 19.9             | 20.1                               | 0.259  | 25.3             | 91                              | 0.116            | 8.3  |
| SM4T15AY/CAY  | 0.2                            | 1     | 13                            | 14.4 | 15.2 | 16.0 | 1   | 21.5             | 18.6                               | 0.298  | 27.2             | 85                              | 0.132            | 8.4  |
| SM4T18AY/CAY  | 0.2                            | 1     | 15                            | 16.7 | 17.6 | 18.5 | 1   | 24.4             | 16.4                               | 0.361  | 32.5             | 71                              | 0.197            | 8.8  |
| SM4T21AY/CAY  | 0.2                            | 1     | 18                            | 20.0 | 21.1 | 22.2 | 1   | 29.2             | 13.7                               | 0.514  | 39.3             | 59                              | 0.291            | 9.2  |
| SM4T23AY/CAY  | 0.2                            | 1     | 20                            | 22.2 | 23.4 | 24.6 | 1   | 32.4             | 12.3                               | 0.637  | 42.8             | 54                              | 0.338            | 9.4  |
| SM4T26AY/CAY  | 0.2                            | 1     | 22                            | 24.4 | 25.7 | 27.0 | 1   | 35.5             | 11.2                               | 0.760  | 48.3             | 48                              | 0.444            | 9.6  |
| SM4T28AY/CAY  | 0.2                            | 1     | 24                            | 26.7 | 28.1 | 29.5 | 1   | 38.9             | 10.3                               | 0.912  | 50               | 46                              | 0.446            | 9.6  |
| SM4T30AY/CAY  | 0.2                            | 1     | 26                            | 28.9 | 30.4 | 31.9 | 1   | 42.1             | 9.5                                | 1.07   | 53.5             | 43                              | 0.502            | 9.7  |
| SM4T33AY/CAY  | 0.2                            | 1     | 28                            | 31.1 | 32.7 | 34.3 | 1   | 45.4             | 8.8                                | 1.26   | 59               | 39                              | 0.632            | 9.8  |
| SM4T35AY/CAY  | 0.2                            | 1     | 30                            | 33.3 | 35.1 | 36.9 | 1   | 48.4             | 8.3                                | 1.39   | 64.3             | 36                              | 0.762            | 9.9  |
| SM4T39AY/CAY  | 0.2                            | 1     | 33                            | 36.7 | 38.6 | 40.5 | 1   | 53.3             | 7.5                                | 1.70   | 69.7             | 33                              | 0.884            | 10   |
| SM4T47AY/CAY  | 0.2                            | 1     | 40                            | 44.4 | 46.7 | 49.0 | 1   | 64.5             | 6.2                                | 2.49   | 84               | 27                              | 1.30             | 10.1 |
| SM4T50AY/CAY  | 0.2                            | 1     | 43                            | 47.8 | 50.3 | 52.8 | 1   | 69.4             | 5.7                                | 2.91   | 91               | 25                              | 1.53             | 10.2 |
| SM4T56AY/CAY  | 0.2                            | 1     | 48                            | 53.3 | 56.1 | 58.9 | 1   | 77.4             | 5.2                                | 3.56   | 100              | 23                              | 1.79             | 10.3 |
| SM4T68AY/CAY  | 0.2                            | 1     | 58                            | 64.4 | 67.8 | 71.2 | 1   | 93.6             | 4.3                                | 5.21   | 121              | 19                              | 2.62             | 10.4 |
| SM4T82AY/CAY  | 0.2                            | 1     | 70                            | 77.8 | 81.9 | 86.0 | 1   | 113              | 3.5                                | 7.72   | 146              | 16                              | 3.75             | 10.5 |

1. Pulse test:  $t_p < 50 \text{ ms}$

2. To calculate maximum clamping voltage at other surge level, use the following formula:  $V_{CL \text{ max}} = V_{CL} - R_D \times (I_{PP} - I_{PPappli})$   
where  $I_{PPappli}$  is the surge current in the application

3. To calculate  $V_{BR}$  or  $V_{CL}$  versus junction temperature, use the following formulas:

$$V_{BR} @ T_J = V_{BR} @ 25\text{ °C} \times (1 + \alpha T \times (T_J - 25))$$

$$V_{CL} @ T_J = V_{CL} @ 25\text{ °C} \times (1 + \alpha T \times (T_J - 25))$$

4. Surge capability given for both directions for unidirectional and bidirectional types.

Figure 3. Peak pulse power dissipation versus initial junction temperature

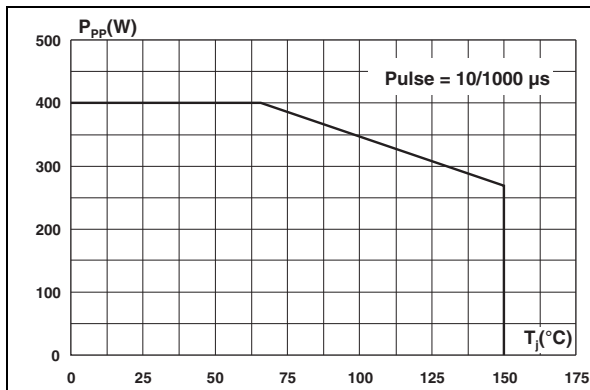

Figure 4. Peak pulse power versus exponential pulse duration ( $T_j$  initial = 25 °C)

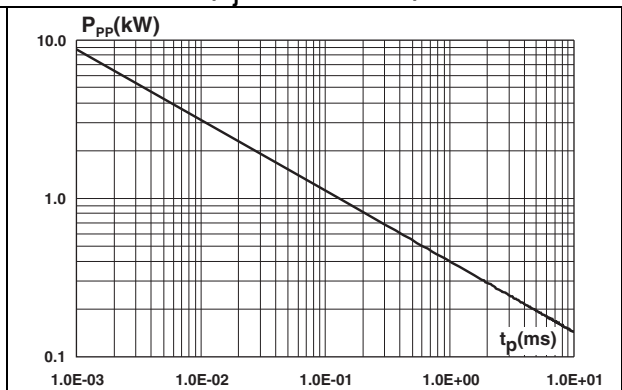

Figure 5. Clamping voltage versus peak pulse current (exponential waveform, maximum values)

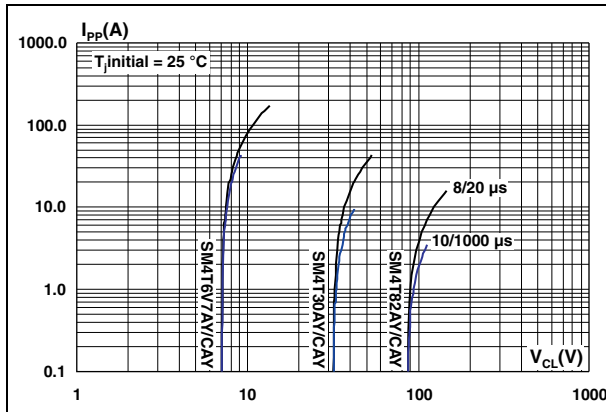

Figure 6. Junction capacitance versus reverse applied voltage for unidirectional types (typical values)

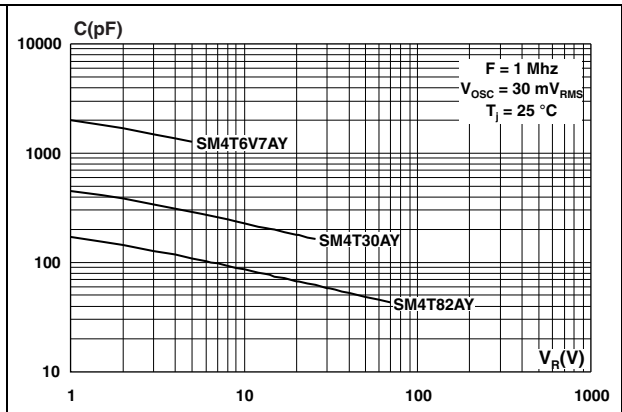

Figure 7. Junction capacitance versus reverse applied voltage for bidirectional types (typical values)

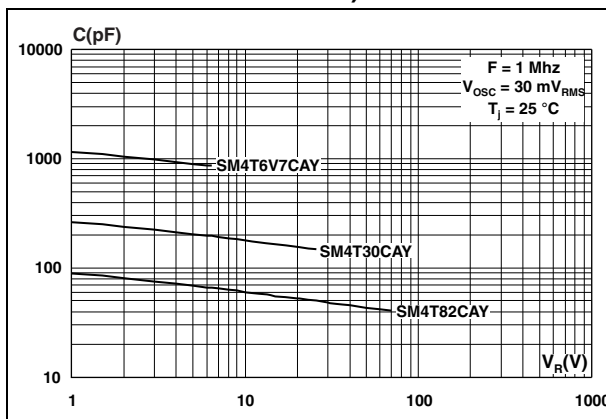

Figure 8. Relative variation of thermal impedance, junction to ambient, versus pulse duration

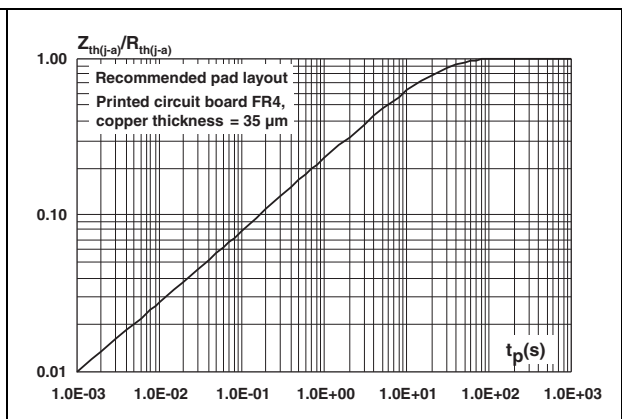

Figure 9. Thermal resistance junction to ambient versus copper surface under each lead

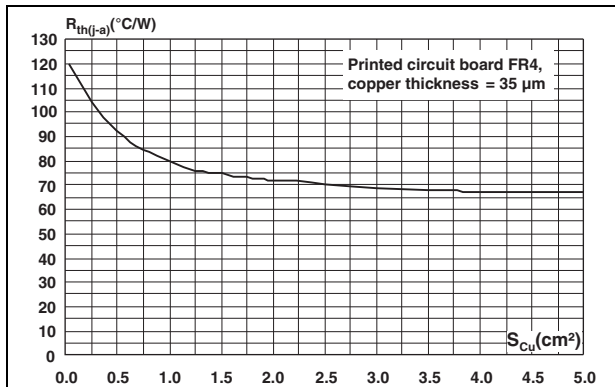

Figure 10. Leakage current versus junction temperature (typical values)

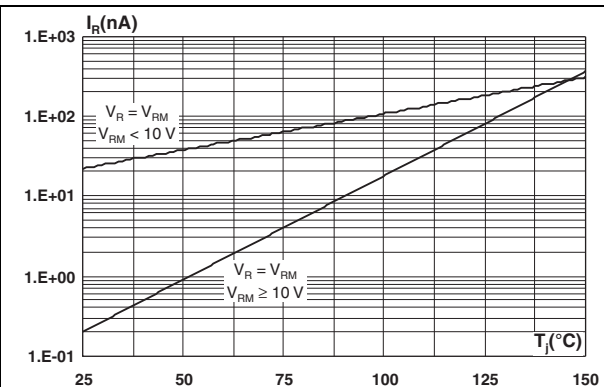

Figure 11. Peak forward voltage drop versus peak forward current (typical values)

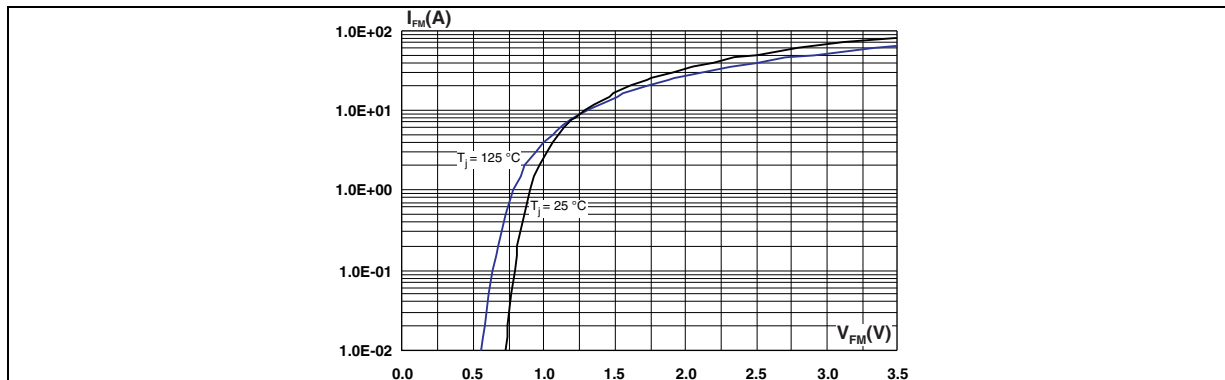

Figure 12. ISO7637-2 pulse 1 response ( $V_S = -100\text{ V}$ )

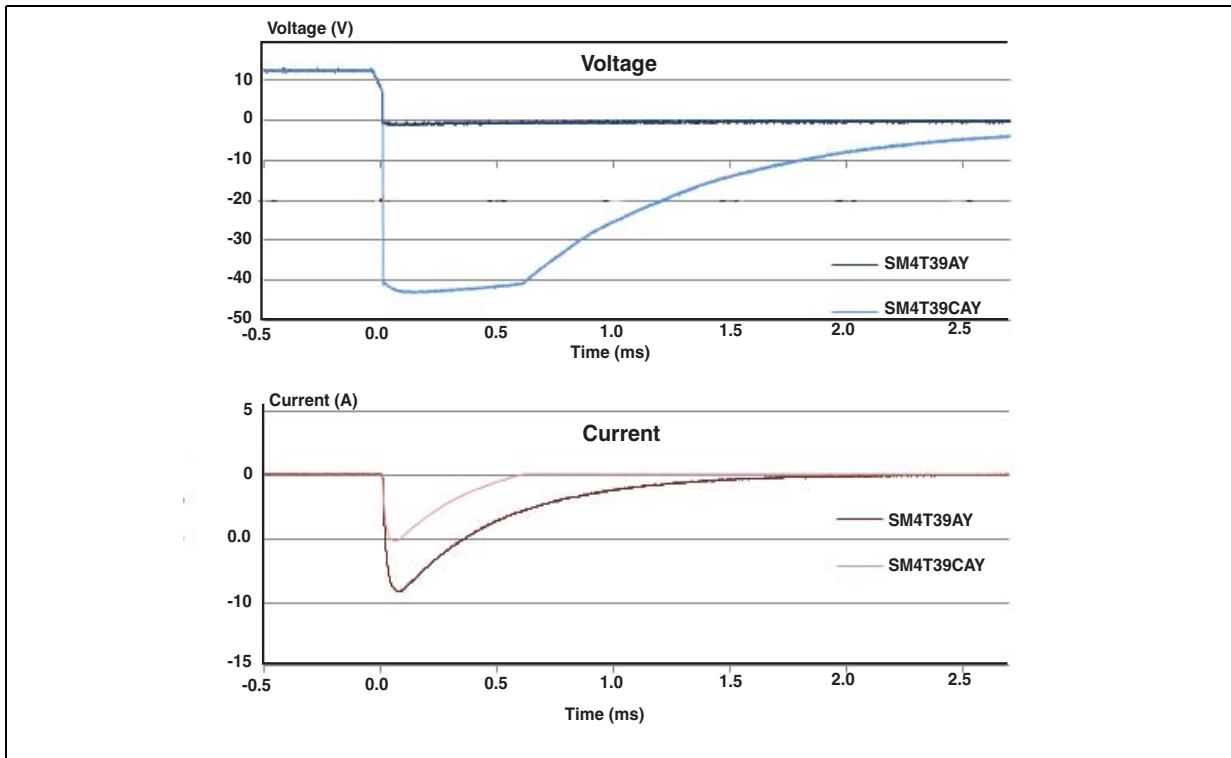

Figure 13. ISO7637-2 pulse 2a response ( $V_S = 50\text{ V}$ )

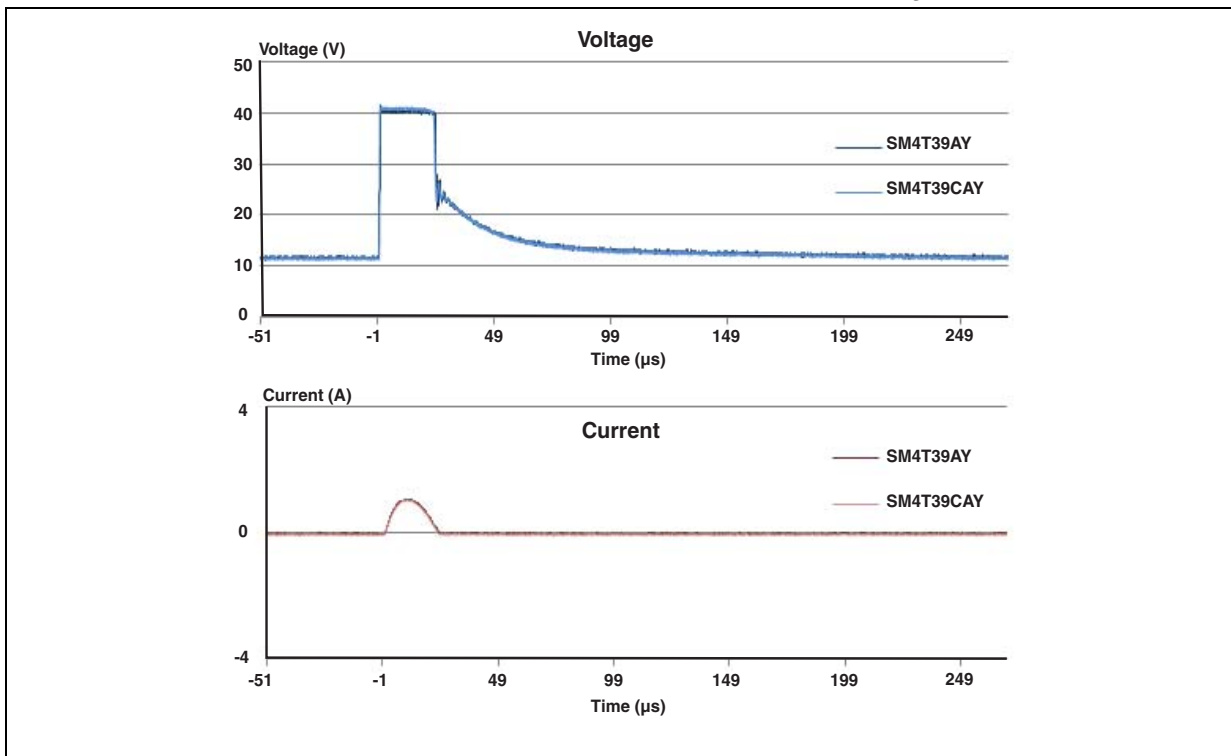

Figure 14. ISO7637-2 pulse 3a response ( $V_S = -150\text{ V}$ )

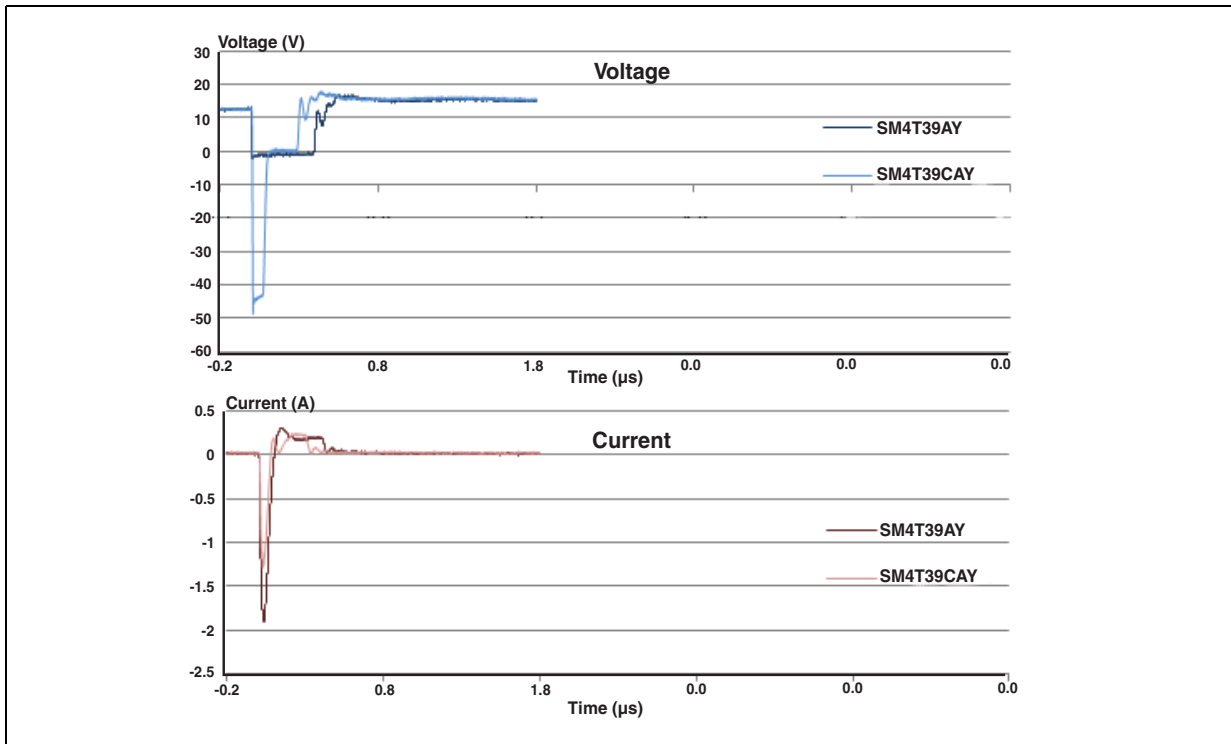
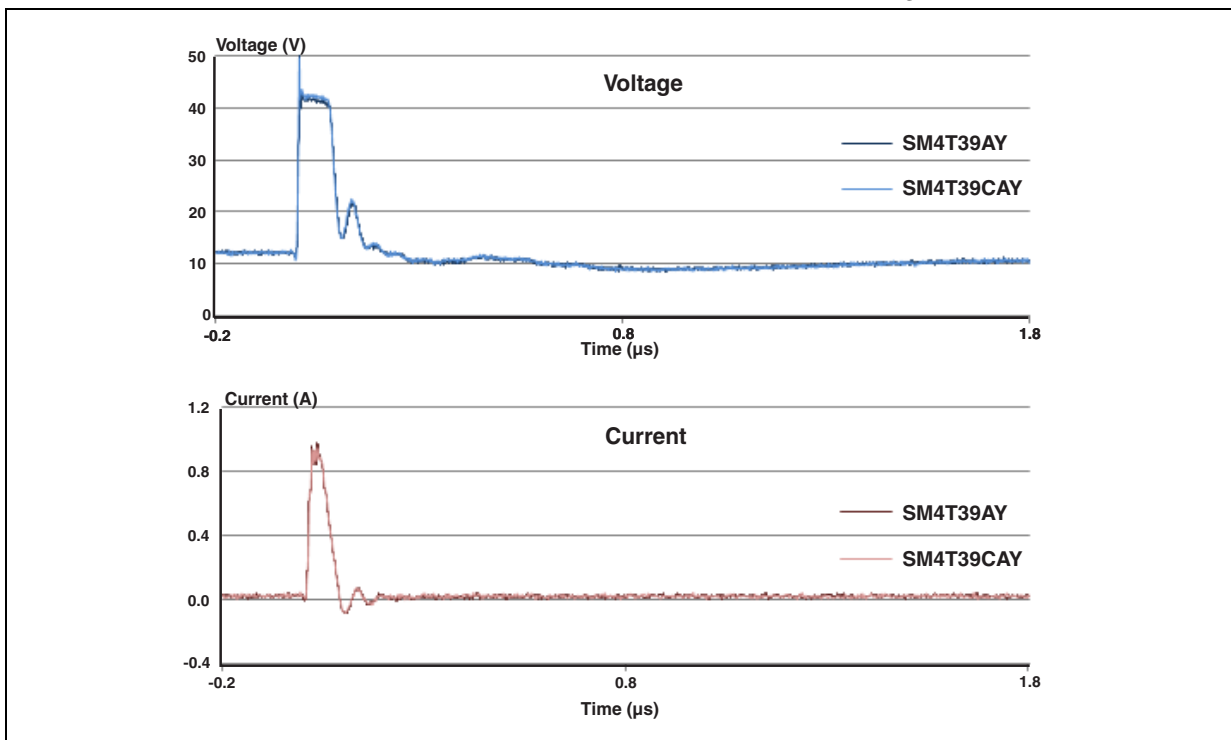

Figure 15. ISO7637-2 pulse 3b response ( $V_S = 100\text{ V}$ )



Note: ISO7637-2 pulses responses are not applicable for product with a stand off voltage lower than the average battery voltage (13.5 V).

## 2 Application and design guidelines

More information is available in the Application note AN2689 "Protection of automotive electronics from electrical hazards, guidelines for design and component selection".

## 3 Ordering information scheme

Figure 16. Ordering information scheme

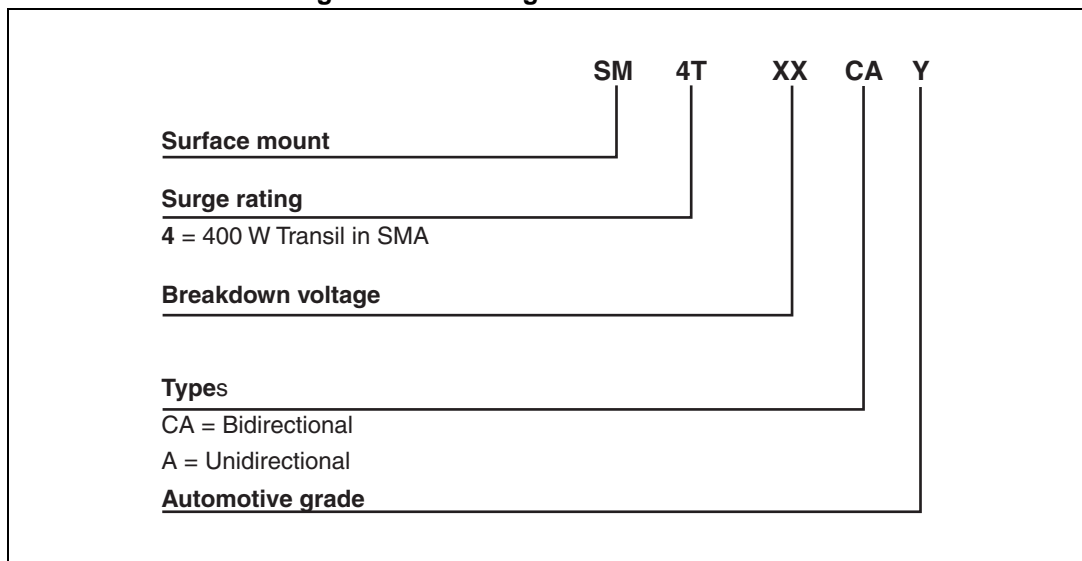

## 4 Package information

- Case: JEDEC DO-214AB molded plastic over planar junction
- Terminals: solder plated, solderable as per MIL-STD-750, Method 2026
- Polarity: for unidirectional types the band indicates cathode
- Flammability: epoxy is rated UL 94, V0
- RoHS package

In order to meet environmental requirements, ST offers these devices in different grades of ECOPACK® packages, depending on their level of environmental compliance. ECOPACK® specifications, grade definitions and product status are available at: [www.st.com](http://www.st.com). ECOPACK® is an ST trademark.

**Table 3. SMA package dimensions**

| Ref. | Dimensions  |      |        |       |
|------|-------------|------|--------|-------|
|      | Millimeters |      | Inches |       |
|      | Min.        | Max. | Min.   | Max.  |
| A1   | 1.90        | 2.45 | 0.075  | 0.094 |
| A2   | 0.05        | 0.20 | 0.002  | 0.008 |
| b    | 1.25        | 1.65 | 0.049  | 0.065 |
| c    | 0.15        | 0.40 | 0.006  | 0.016 |
| D    | 2.25        | 2.90 | 0.089  | 0.114 |
| E    | 4.80        | 5.35 | 0.189  | 0.211 |
| E1   | 3.95        | 4.60 | 0.156  | 0.181 |
| L    | 0.75        | 1.50 | 0.030  | 0.059 |

**Figure 17. SMA footprint dimensions in mm (inches)**

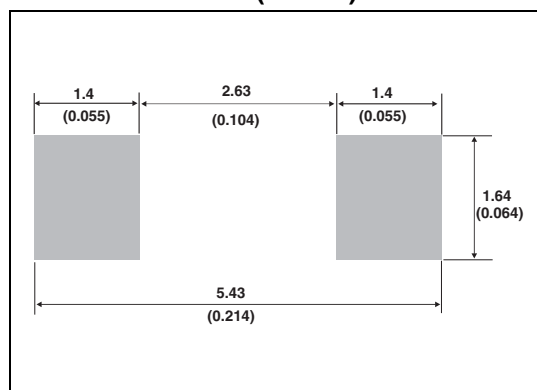

**Figure 18. Marking layout<sup>(1)</sup>**

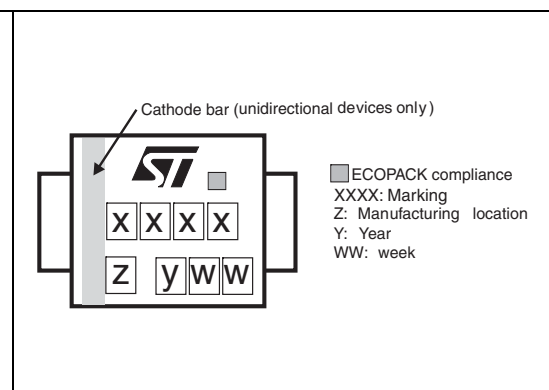

1. Marking layout can vary according to assembly location.

Table 4. Marking

| Order code | Marking | Order code | Marking |
|------------|---------|------------|---------|
| SM4T6V7AY  | AEY     | SM4T6V7CAY | AAY     |
| SM4T7V6AY  | DUCY    | SM4T7V5CAY | DBCY    |
| SM4T10AY   | DUHY    | SM4T10CAY  | DBHY    |
| SM4T12AY   | AXY     | SM4T12CAY  | ACY     |
| SM4T14AY   | DUKY    | SM4T14CAY  | DBKY    |
| SM4T15AY   | BGY     | SM4T15CAY  | BHY     |
| SM4T18AY   | BMY     | SM4T18CAY  | AJY     |
| SM4T21AY   | DUQY    | SM4T21CAY  | DBQY    |
| SM4T23AY   | DURY    | SM4T23CAY  | DBRY    |
| SM4T26AY   | DUSY    | SM4T26CAY  | DBSY    |
| SM4T28AY   | DUTY    | SM4T28CAY  | DBTY    |
| SM4T30AY   | DUJY    | SM4T30CAY  | DBUY    |
| SM4T33AY   | CGY     | SM4T33CAY  | CHY     |
| SM4T35AY   | CKY     | SM4T35CAY  | CLY     |
| SM4T39AY   | CMY     | SM4T39CAY  | CNY     |
| SM4T47AY   | DUZY    | SM4T47CAY  | DBZY    |
| SM4T50AY   | EUAY    | SM4T50CAY  | EBAY    |
| SM4T56AY   | CXY     | SM4T56CAY  | CYY     |
| SM4T68AY   | EUFY    | SM4T68CAY  | EBFY    |
| SM4T82AY   | EUIY    | SM4T82CAY  | EBIY    |

## 5 Ordering information

**Table 5. Ordering information**

| Order code                   | Marking                                | Package | Weight  | Base qty | Delivery mode |
|------------------------------|--|---------|---------|----------|---------------|
| SM4TxxxAY/CAY <sup>(1)</sup> | See <a href="#">Table 4 on page 10</a> | SMA     | 0.072 g | 5000     | Tape and reel |

1. Where xxx is nominal value of  $V_{BR}$  and A or CA indicates unidirectional or bidirectional version. See [Table 2](#) for list of available devices and their order codes

## 6 Revision history

**Table 6. Document revision history**

| Date        | Revision | Changes  |
|-------------|----------|--|
| 08-Sep-2010 | 1        | Initial release.   |
| 09-Nov-2011 | 2        | Added order codes in Table 2 and Table 4. Updated Figure 5, 6 and 7. |
| 27-Mar-2012 | 3        | Added footnote on page 1.  |
| 05-Oct-2015 | 4        | Updated <a href="#">Table 1</a> .                                    |

**IMPORTANT NOTICE – PLEASE READ CAREFULLY**

STMicroelectronics NV and its subsidiaries ("ST") reserve the right to make changes, corrections, enhancements, modifications, and improvements to ST products and/or to this document at any time without notice. Purchasers should obtain the latest relevant information on ST products before placing orders. ST products are sold pursuant to ST's terms and conditions of sale in place at the time of order acknowledgement.

Purchasers are solely responsible for the choice, selection, and use of ST products and ST assumes no liability for application assistance or the design of Purchasers' products.

No license, express or implied, to any intellectual property right is granted by ST herein.

Resale of ST products with provisions different from the information set forth herein shall void any warranty granted by ST for such product.

ST and the ST logo are trademarks of ST. All other product or service names are the property of their respective owners.

Information in this document supersedes and replaces information previously supplied in any prior versions of this document.

© 2015 STMicroelectronics – All rights reserved

## Looking for pricing, stock, or lifecycle information?

Click below to explore more details on WIN SOURCE:

-  [View SM4T33CAY on WIN SOURCE](#)
-  [STMicroelectronics Information](#)

## Optimize Your Supply Chain with WIN SOURCE Solutions

-  Global Sourcing Solution
-  Obsolete Management
-  Cost Control Management
-  Shortage Management
-  Alternative Solution
-  Excess Inventory Management