



**THE DATASHEET OF
DMP4025LSS-13**



40V P-CHANNEL ENHANCEMENT MODE MOSFET

Product Summary

$V_{(BR)DSS}$	$R_{DS(on) \max}$	$I_D \max (A)$ $T_A = 25^\circ C$ (Notes 6)
-40V	25m Ω @ $V_{GS} = -10V$	-8.0
	45m Ω @ $V_{GS} = -4.5V$	-6.0

Description and Applications

This MOSFET has been designed to minimize the on-state resistance and yet maintain superior switching performance, making it ideal for high efficiency power management applications.

- Motor control
- Backlighting
- DC-DC Converters
- Printer equipment

Features and Benefits

- Low $R_{DS(on)}$ – Minimizes conduction losses
- Fast switching speed – Minimizes switching losses
- **Totally Lead-Free & Fully RoHS compliant (Notes 1 & 2)**
- **Halogen and Antimony Free. "Green" Device (Note 3)**
- **Qualified to AEC-Q101 Standards for High Reliability**

Mechanical Data

- Case: SO-8
- Case Material: Molded Plastic, "Green" Molding Compound. UL Flammability Classification Rating 94V-0 (Note 1)
- Moisture Sensitivity: Level 1 per J-STD-020
- Terminals: Finish - Matte Tin annealed over Copper lead frame. Solderable per MIL-STD-202, Method 208
- Weight: 0.074 grams (approximate)

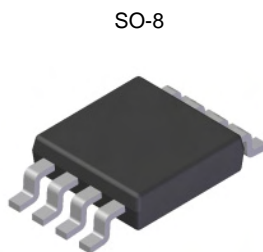

Top View

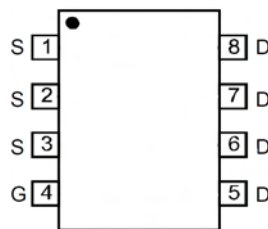

Pin-Out Top View

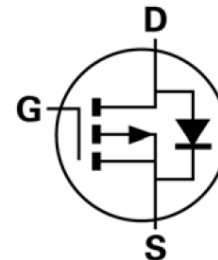

Device symbol

Ordering Information (Note 4)

Product	Marking	Reel size (inches)	Tape width (mm)	Quantity per reel
DMP4025LSS-13	P4025LS	13	12	2,500

- Notes:
1. No purposely added lead. Fully EU Directive 2002/95/EC (RoHS) & 2011/65/EU (RoHS 2) compliant.
 2. See <http://www.diodes.com> for more information about Diodes Incorporated's definitions of Halogen and Antimony free, "Green" and Lead-Free.
 3. Halogen and Antimony free "Green" products are defined as those which contain <900ppm bromine, <900ppm chlorine (<1500ppm total Br + Cl) and <1000ppm antimony compounds.
 4. For packaging details, go to our website at <http://www.diodes.com>

Marking Information

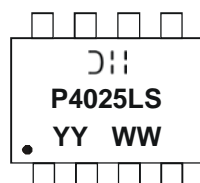

- △ = Manufacturer's Marking
- P4025LS = Product Type Marking Code
- YYWW = Date Code Marking
- YY = Year (ex: 10 = 2010)
- WW = Week (01 - 53)

Maximum Ratings @ $T_A = 25^\circ\text{C}$ unless otherwise specified

Characteristic			Symbol	Value	Units	
Drain-Source Voltage			V_{DSS}	-40	V	
Gate-Source Voltage			V_{GSS}	± 20		
Continuous Drain Current	$V_{GS} = -10\text{V}$	(Notes 6)	I_D	-8.0	A	
		$T_A = 70^\circ\text{C}$ (Notes 6)		-6.9		
		(Notes 5)		-6.0		
Pulsed Drain Current	$V_{GS} = -10\text{V}$	(Notes 7)	I_{DM}	-30		
Continuous Source Current (Body diode)			(Notes 7)	I_S		-8.0
Pulsed Source Current (Body diode)			(Notes 7)	I_{SM}		-30

Thermal Characteristics @ $T_A = 25^\circ\text{C}$ unless otherwise specified

Characteristic			Symbol	Value	Unit
Power Dissipation	(Notes 5)	P_D		1.52	W
	(Notes 6)			2.4	
Thermal Resistance, Junction to Ambient	(Notes 5)	$R_{\theta JA}$		82	$^\circ\text{C/W}$
	(Notes 6)			52	
Thermal Resistance, Junction to Lead	(Notes 8)	$R_{\theta JL}$		48.85	
Operating and Storage Temperature Range			T_J, T_{STG}	-55 to +150	$^\circ\text{C}$

- Notes:
5. For a device surface mounted on minimum recommended FR4 PCB with high coverage of single sided 1oz copper, in still air conditions; the device is measured when operating in a steady-state condition.
 6. Same as note (2), except the device is surface mounted on 25mm X 25mm X 1.6mm FR4 PCB.
 7. Repetitive rating on 25mm X 25mm FR4 PCB, $D=0.02$, pulse width 300 μs – pulse width by maximum junction temperature.
 8. Thermal resistance from junction to solder-point (at the end of the drain lead).

Thermal Characteristics

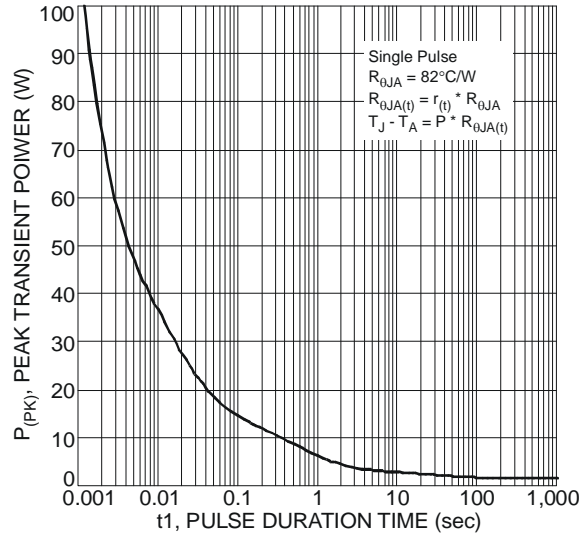

Fig. 1 Single Pulse Maximum Power Dissipation

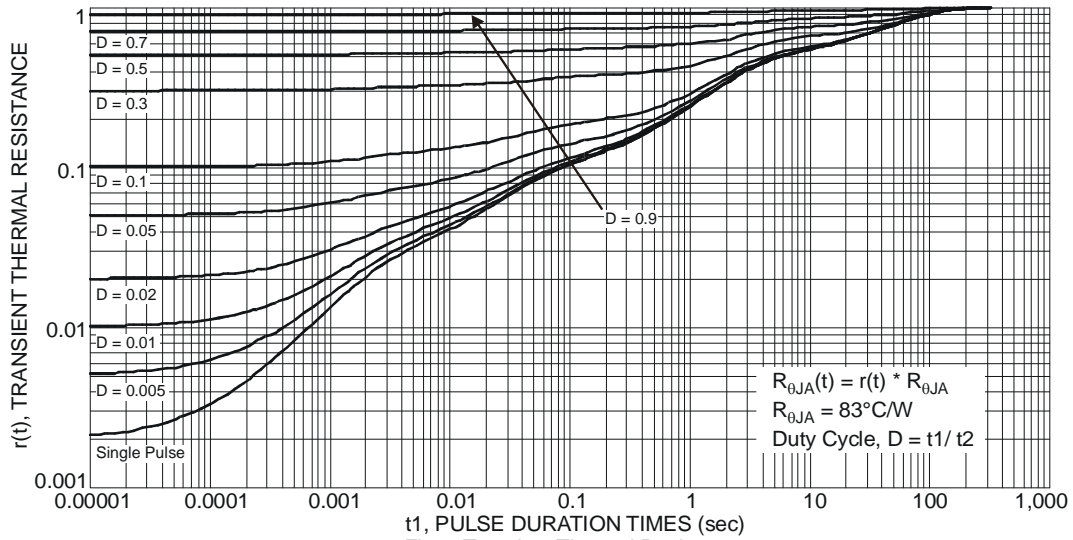

Fig. 2 Transient Thermal Resistance

Electrical Characteristics $T_A = 25^\circ\text{C}$ unless otherwise specified

Characteristic	Symbol	Min	Typ	Max	Unit	Test Condition
OFF CHARACTERISTICS						
Drain-Source Breakdown Voltage	BV_{DSS}	-40	—	—	V	$I_D = -250\mu\text{A}$, $V_{GS} = 0\text{V}$
Zero Gate Voltage Drain Current	I_{DSS}	—	—	-1.0	μA	$V_{DS} = -40\text{V}$, $V_{GS} = 0\text{V}$
Gate-Source Leakage	I_{GSS}	—	—	± 100	nA	$V_{GS} = \pm 20\text{V}$, $V_{DS} = 0\text{V}$
ON CHARACTERISTICS						
Gate Threshold Voltage	$V_{GS(th)}$	-0.8	-1.3	-1.8	V	$I_D = -250\mu\text{A}$, $V_{DS} = V_{GS}$
Static Drain-Source On-Resistance (Note 9)	$R_{DS(ON)}$	—	18	25	m Ω	$V_{GS} = -10\text{V}$, $I_D = -3\text{A}$
			30	45		$V_{GS} = -4.5\text{V}$, $I_D = -3\text{A}$
Forward Transconductance (Notes 9 & 10)	g_{fs}	—	16.6	—	S	$V_{DS} = -5\text{V}$, $I_D = -3\text{A}$
Diode Forward Voltage (Note 9)	V_{SD}	—	-0.7	-1.0	V	$I_S = -1\text{A}$, $V_{GS} = 0\text{V}$
DYNAMIC CHARACTERISTICS (Note 10)						
Input Capacitance	C_{iss}	—	1640	—	pF	$V_{DS} = -20\text{V}$, $V_{GS} = 0\text{V}$ $f = 1\text{MHz}$
Output Capacitance	C_{oss}	—	179	—		
Reverse Transfer Capacitance	C_{rss}	—	128	—		
Gate Resistance	R_g	—	6.43	—	Ω	$V_{DS} = 0\text{V}$, $V_{GS} = 0\text{V}$, $f = 1\text{MHz}$
Total Gate Charge (Note 11)	Q_g	—	14.0	—	nC	$V_{GS} = -4.5\text{V}$ $V_{GS} = -10\text{V}$ $V_{DS} = -20\text{V}$ $I_D = -3\text{A}$
Total Gate Charge (Note 11)	Q_{g1}	—	33.7	—		
Gate-Source Charge (Note 11)	Q_{gs}	—	5.5	—		
Gate-Drain Charge (Note 11)	Q_{gd}	—	7.3	—		
Turn-On Delay Time (Note 11)	$t_{D(on)}$	—	6.9	—	ns	$V_{DD} = -20\text{V}$, $V_{GS} = -10\text{V}$ $I_D = -3\text{A}$
Turn-On Rise Time (Note 11)	t_r	—	14.7	—		
Turn-Off Delay Time (Note 11)	$t_{D(off)}$	—	53.7	—		
Turn-Off Fall Time (Note 11)	t_f	—	30.9	—		

Notes: 9. Measured under pulsed conditions. Pulse width $\leq 300\mu\text{s}$; duty cycle $\leq 2\%$
 10. For design aid only, not subject to production testing.
 11. Switching characteristics are independent of operating junction temperatures.

Typical Characteristics

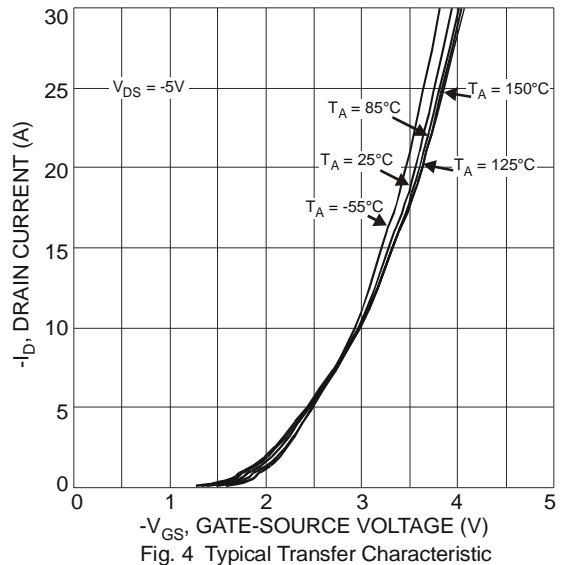
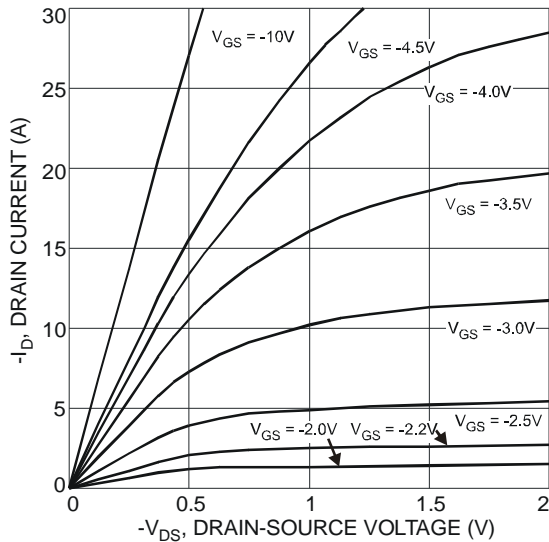

DMP4025LSS

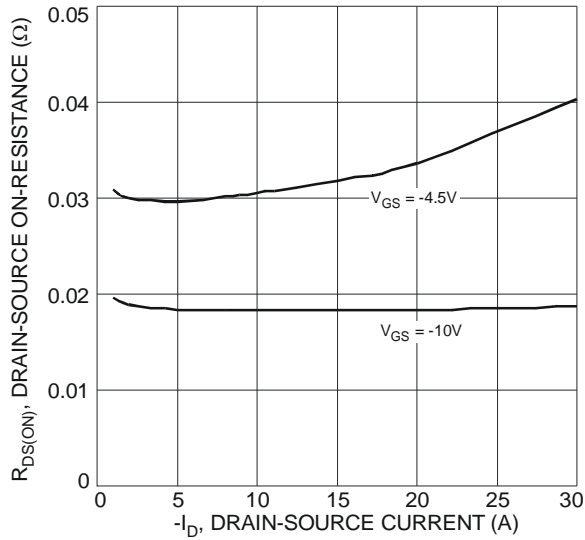

Fig. 5 Typical On-Resistance vs. Drain Current and Gate Voltage

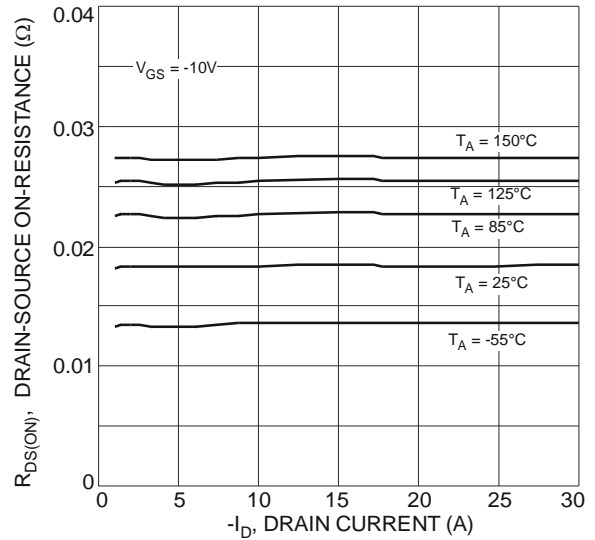

Fig. 6 Typical On-Resistance vs. Drain Current and Temperature

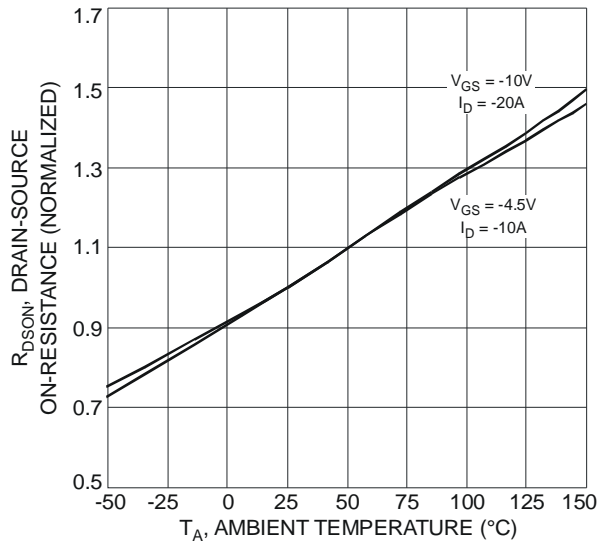

Fig. 7 On-Resistance Variation with Temperature

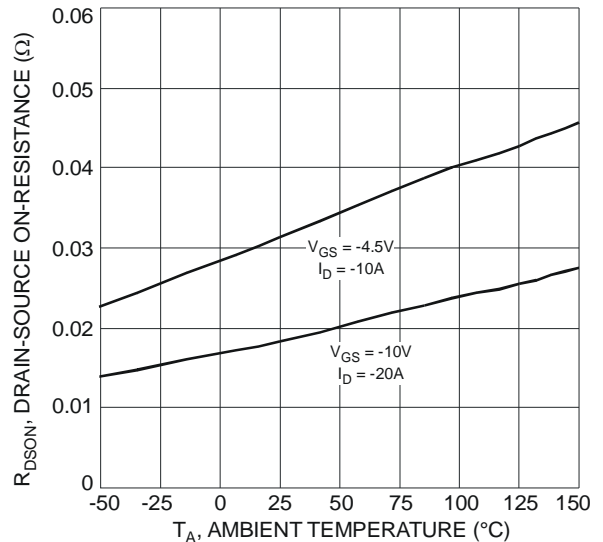

Fig. 8 On-Resistance Variation with Temperature

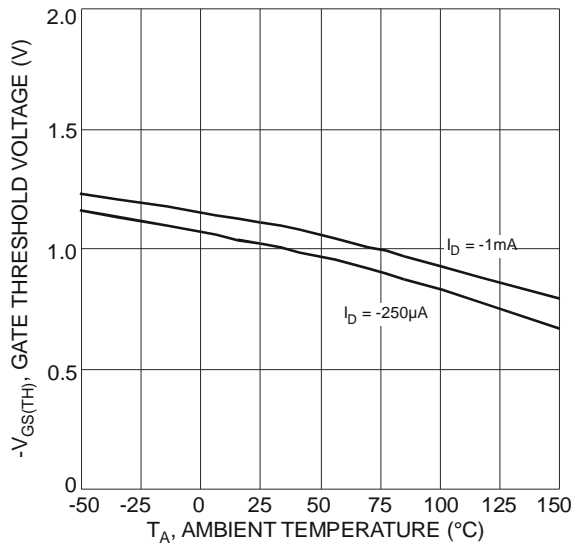

Fig. 9 Gate Threshold Variation vs. Ambient Temperature

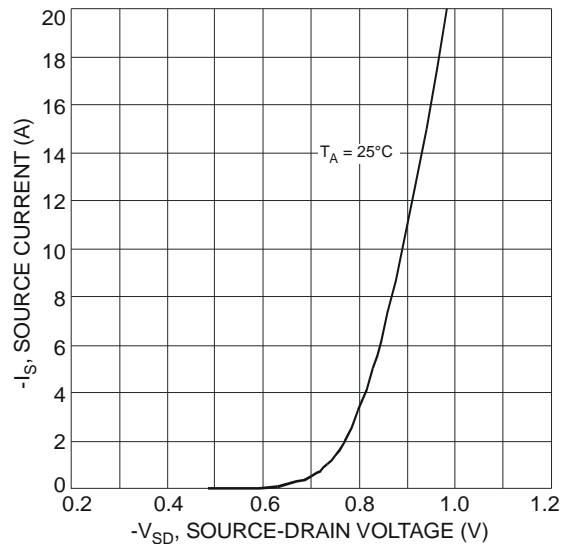
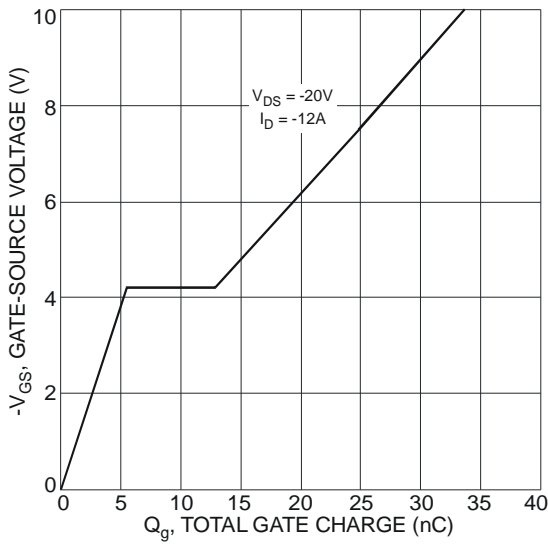
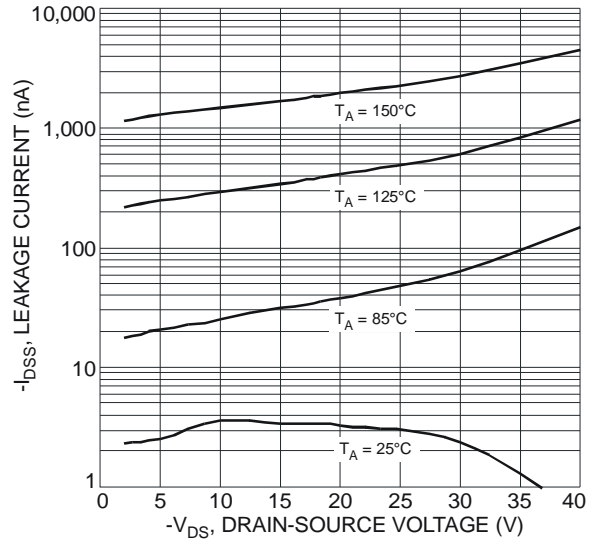
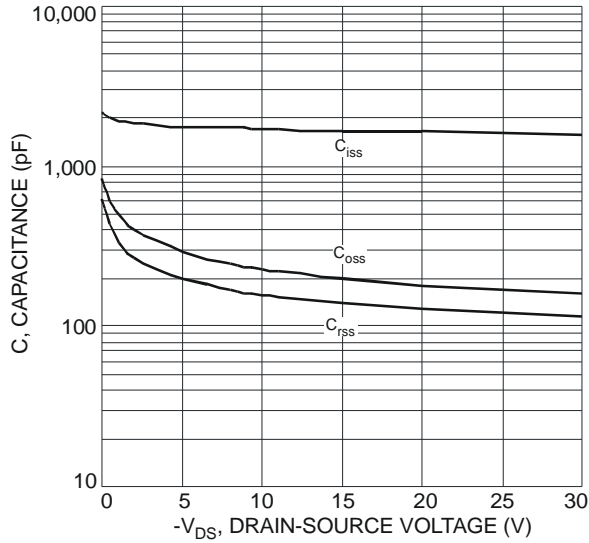
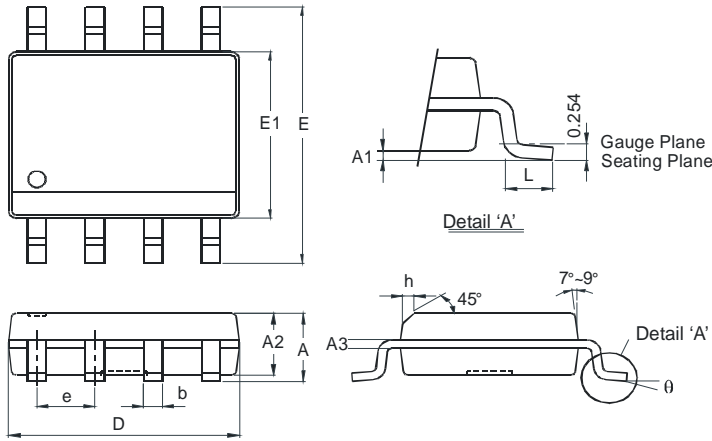

Fig. 10 Diode Forward Voltage vs. Current

DMP4025LSS



Package Outline Dimensions



SO-8		
Dim	Min	Max
A	-	1.75
A1	0.10	0.20
A2	1.30	1.50
A3	0.15	0.25
b	0.3	0.5
D	4.85	4.95
E	5.90	6.10
E1	3.85	3.95
e	1.27 Typ	
h	-	0.35
L	0.62	0.82
θ	0°	8°
All Dimensions in mm		

Suggested Pad Layout

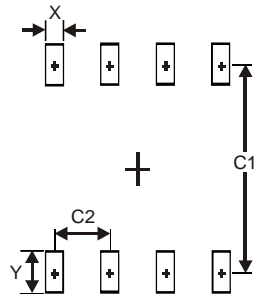

Dimensions	Value (in mm)
X	0.60
Y	1.55
C1	5.4
C2	1.27

IMPORTANT NOTICE

DIODES INCORPORATED MAKES NO WARRANTY OF ANY KIND, EXPRESS OR IMPLIED, WITH REGARDS TO THIS DOCUMENT, INCLUDING, BUT NOT LIMITED TO, THE IMPLIED WARRANTIES OF MERCHANTABILITY AND FITNESS FOR A PARTICULAR PURPOSE (AND THEIR EQUIVALENTS UNDER THE LAWS OF ANY JURISDICTION).

Diodes Incorporated and its subsidiaries reserve the right to make modifications, enhancements, improvements, corrections or other changes without further notice to this document and any product described herein. Diodes Incorporated does not assume any liability arising out of the application or use of this document or any product described herein; neither does Diodes Incorporated convey any license under its patent or trademark rights, nor the rights of others. Any Customer or user of this document or products described herein in such applications shall assume all risks of such use and will agree to hold Diodes Incorporated and all the companies whose products are represented on Diodes Incorporated website, harmless against all damages.

Diodes Incorporated does not warrant or accept any liability whatsoever in respect of any products purchased through unauthorized sales channel. Should Customers purchase or use Diodes Incorporated products for any unintended or unauthorized application, Customers shall indemnify and hold Diodes Incorporated and its representatives harmless against all claims, damages, expenses, and attorney fees arising out of, directly or indirectly, any claim of personal injury or death associated with such unintended or unauthorized application.

Products described herein may be covered by one or more United States, international or foreign patents pending. Product names and markings noted herein may also be covered by one or more United States, international or foreign trademarks.

LIFE SUPPORT

Diodes Incorporated products are specifically not authorized for use as critical components in life support devices or systems without the express written approval of the Chief Executive Officer of Diodes Incorporated. As used herein:

- A. Life support devices or systems are devices or systems which:
 - 1. are intended to implant into the body, or
 - 2. support or sustain life and whose failure to perform when properly used in accordance with instructions for use provided in the labeling can be reasonably expected to result in significant injury to the user.
- B. A critical component is any component in a life support device or system whose failure to perform can be reasonably expected to cause the failure of the life support device or to affect its safety or effectiveness.



Customers represent that they have all necessary expertise in the safety and regulatory ramifications of their life support devices or systems, and acknowledge and agree that they are solely responsible for all legal, regulatory and safety-related requirements concerning their products and any use of Diodes Incorporated products in such safety-critical, life support devices or systems, notwithstanding any devices- or systems-related information or support that may be provided by Diodes Incorporated. Further, Customers must fully indemnify Diodes Incorporated and its representatives against any damages arising out of the use of Diodes Incorporated products in such safety-critical, life support devices or systems.

Copyright © 2012, Diodes Incorporated

www.diodes.com

Looking for pricing, stock, or lifecycle information?

Click below to explore more details on WIN SOURCE:

-  [View DMP4025LSS-13 on WIN SOURCE](#)
-  [Diodes Incorporated Information](#)

Optimize Your Supply Chain with WIN SOURCE Solutions

-  Global Sourcing Solution
-  Obsolete Management
-  Cost Control Management
-  Shortage Management
-  Alternative Solution
-  Excess Inventory Management