



THE DATASHEET OF 1KSMB27A



1KSMB Series



Agency Approvals

AGENCY	AGENCY FILE NUMBER
	E230531

Maximum Ratings and Thermal Characteristics (T_A=25°C unless otherwise noted)

Parameter	Symbol	Value	Unit
Peak Pulse Power Dissipation at T _A =25°C by 10/1000µs Waveform (Fig.2)(Note 1), (Note 2)	P _{PPM}	1000	W
Power Dissipation on Infinite Heat Sink at T _L =50°C	P _D	5.0	W
Peak Forward Surge Current, 8.3ms Single Half Sine Wave (Note 3)	I _{FSM}	120	A
Maximum Instantaneous Forward Voltage at 50A for Unidirectional Only	V _F	3.5	V
Operating Temperature Range	T _J	-65 to 150	°C
Storage Temperature Range	T _{STG}	-65 to 175	°C
Typical Thermal Resistance Junction to Lead	R _{θJL}	20	°C/W
Typical Thermal Resistance Junction to Ambient	R _{θJA}	100	°C/W

Notes:

1. Non-repetitive current pulse, per Fig. 4 and derated above T_J (initial) =25°C per Fig. 3.
2. Mounted on copper pad area of 0.2x0.2" (5.0 x 5.0mm) to each terminal.
3. Measured on 8.3ms single half sine wave or equivalent square wave for unidirectional device only, duty cycle=4 per minute maximum.

Functional Diagram

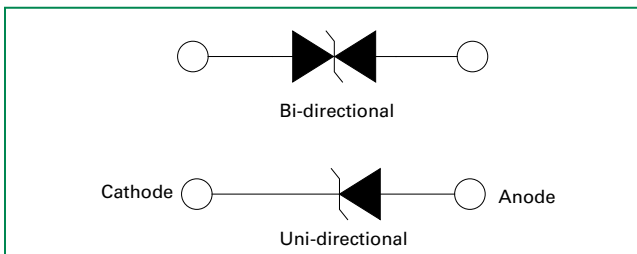

Description

The 1KSMB series is designed specifically to protect sensitive electronic equipment from voltage transients induced by lightning and other transient voltage events.

Features

- 1000W peak pulse power capability at 10/1000µs waveform, repetition rate (duty cycles):0.01%
- For surface mounted applications to optimize board space
- Low profile package
- Typical failure mode is short from over-specified voltage or current
- Whisker test is conducted based on JEDEC JESD201A per its table 4a and 4c
- IEC-61000-4-2 ESD 30kV(Air), 30kV (Contact)
- ESD protection of data lines in accordance with IEC 61000-4-2
- EFT protection of data lines in accordance with IEC 61000-4-4
- Built-in strain relief
- V_{BR} @T_J=V_{BR} @25°C x (1+αT x (T_J - 25)) (αT:Temperature Coefficient, typical value is 0.1%)
- Glass passivated chip junction
- Fast response time: typically less than 1.0ps from 0V to BV min
- Excellent clamping capability
- Low incremental surge resistance
- Typical I_R less than 1µA when V_{BR} max>12V
- High temperature to reflow soldering guaranteed: 260°C/40sec
- Plastic package is flammability rated V-0 per Underwriters Laboratories
- Meet MSL level1, per J-STD-020, LF maximum peak of 260°C
- Matte tin lead-free Plated
- Available in breakdown Voltage from 6.8V to 180V specially designed for automotive applications
- Offers high-surge rating in compact package: bridges the gap between 600W and 1.5KW
- Halogen free and RoHS compliant
- Pb-free E3 means 2nd level interconnect is Pb-free and the terminal finish material is tin(Sn) (IPC/JEDEC J-STD-609A.01)

Applications

TVS devices are ideal for the protection of I/O Interfaces, V_{CC} bus and other vulnerable circuits used in Telecom, Computer, Industrial and Consumer electronic applications.

Additional Information



Datasheet



Resources



Samples

Electrical Characteristics (T_A=25°C unless otherwise noted)

Part Number (Uni)	Part Number (Bi)	Marking		Reverse Stand off Voltage V _R (Volts)	Breakdown Voltage V _{BR} (Volts) @ I _T		Test Current I _T (mA)	Maximum Clamping Voltage V _C @ I _{pp} (V)	Maximum Peak Pulse Current I _{pp} (A)	Maximum Reverse Leakage I _R @ V _R (µA)	Agency Approval 
		UNI	BI		MIN	MAX					
1KSMB6.8A	1KSMB6.8CA	A10A	N10A	5.80	6.45	7.14	10	10.5	95.2	900	x
1KSMB7.5A	1KSMB7.5CA	A10B	N10B	6.40	7.13	7.88	10	11.3	88.5	400	x
1KSMB8.2A	1KSMB8.2CA	A10C	N10C	7.02	7.79	8.61	10	12.1	82.6	180	x
1KSMB9.1A	1KSMB9.1CA	A10D	N10D	7.78	8.65	9.55	1	13.4	74.6	45	x
1KSMB10A	1KSMB10CA	A10E	N10E	8.55	9.50	10.50	1	14.5	69.0	8	x
1KSMB11A	1KSMB11CA	A10F	N10F	9.40	10.50	11.60	1	15.6	64.1	4	x
1KSMB12A	1KSMB12CA	A10G	N10G	10.20	11.40	12.60	1	16.7	59.9	1	x
1KSMB13A	1KSMB13CA	A10H	N10H	11.10	12.40	13.70	1	18.2	54.9	1	x
1KSMB15A	1KSMB15CA	A10I	N10I	12.80	14.30	15.80	1	21.2	47.2	1	x
1KSMB16A	1KSMB16CA	A10J	N10J	13.60	15.20	16.80	1	22.5	44.4	1	x
1KSMB18A	1KSMB18CA	A10K	N10K	15.30	17.10	18.90	1	25.5	39.2	1	x
1KSMB20A	1KSMB20CA	A10L	N10L	17.10	19.00	21.00	1	27.7	36.1	1	x
1KSMB22A	1KSMB22CA	A10M	N10M	18.80	20.90	23.10	1	30.6	32.7	1	x
1KSMB24A	1KSMB24CA	A10N	N10N	20.50	22.80	25.20	1	33.2	30.1	1	x
1KSMB27A	1KSMB27CA	A10O	N10O	23.10	25.70	28.40	1	37.5	26.7	1	x
1KSMB30A	1KSMB30CA	A10P	N10P	25.60	28.50	31.50	1	41.4	24.2	1	x
1KSMB33A	1KSMB33CA	A10Q	N10Q	28.20	31.40	34.70	1	45.7	21.9	1	x
1KSMB36A	1KSMB36CA	A10R	N10R	30.80	34.20	37.80	1	49.9	20.0	1	x
1KSMB39A	1KSMB39CA	A10S	N10S	33.30	37.10	41.00	1	53.9	18.6	1	x
1KSMB43A	1KSMB43CA	A10T	N10T	36.80	40.90	45.20	1	59.3	16.9	1	x
1KSMB47A	1KSMB47CA	A10U	N10U	40.20	44.70	49.40	1	64.8	15.4	1	x
1KSMB51A	1KSMB51CA	A10V	N10V	43.60	48.50	53.60	1	70.1	14.3	1	x
1KSMB56A	1KSMB56CA	A10W	N10W	47.80	53.20	58.80	1	77.0	13.0	1	x
1KSMB62A	1KSMB62CA	A10X	N10X	53.00	58.90	65.10	1	85.0	11.8	1	x
1KSMB68A	1KSMB68CA	A10Y	N10Y	58.10	64.60	71.40	1	92.0	10.9	1	x
1KSMB75A	1KSMB75CA	A10Z	N10Z	64.10	71.30	78.80	1	103.0	9.7	1	x
1KSMB82A	1KSMB82CA	B10A	O10A	70.10	77.90	86.10	1	113.0	8.8	1	x
1KSMB91A	1KSMB91CA	B10B	O10B	77.80	86.50	95.50	1	125.0	8.0	1	x
1KSMB100A	1KSMB100CA	B10C	O10C	85.50	95.00	105.00	1	137.0	7.3	1	x
1KSMB110A	1KSMB110CA	B10D	O10D	94.00	105.00	116.00	1	152.0	6.6	1	x
1KSMB120A	1KSMB120CA	B10E	O10E	102.00	114.00	126.00	1	165.0	6.1	1	x
1KSMB130A	1KSMB130CA	B10F	O10F	111.00	124.00	137.00	1	179.0	5.6	1	x
1KSMB150A	1KSMB150CA	B10G	O10G	128.00	143.00	158.00	1	207.0	4.8	1	x
1KSMB160A	1KSMB160CA	B10H	O10H	136.00	152.00	168.00	1	219.0	4.6	1	x
1KSMB170A	1KSMB170CA	B10I	O10I	144.50	162.00	179.00	1	234.0	4.3	1	x
1KSMB180A	1KSMB180CA	B10J	O10J	153.00	171.00	189.00	1	246.0	4.1	1	x

For bidirectional type having V_R of 10 volts and less, the I_R limit is double.

For parts without A V_{BR} is ± 10% and V_C is 5% higher than with A parts.

I-V Curve Characteristics



- P_{PPM} Peak Pulse Power Dissipation** – Max power dissipation
- V_R Stand-off Voltage** – Maximum voltage that can be applied to the TVS without operation
- V_{BR} Breakdown Voltage** – Maximum voltage that flows thogh the TVS at a specified test current (I_T)
- V_C Clamping Voltage** – Peak voltage measured across the TVS at a specified I_{ppm} (peak impulse current)
- I_R Reverse Leakage Current** – Current measured at V_R
- V_F Forward Voltage Drop for Uni-directional**

Ratings and Characteristic Curves (T_A = 25°C unless otherwise noted)

Figure 1 - TVS Transients Clamping Waveform



Figure 2 - Peak Pulse Power Rating Curve



continues on next page.

Ratings and Characteristic Curves ($T_A=25^\circ\text{C}$ unless otherwise noted) (Continued)

Figure 3 - Peak Pulse Power Derating Curve

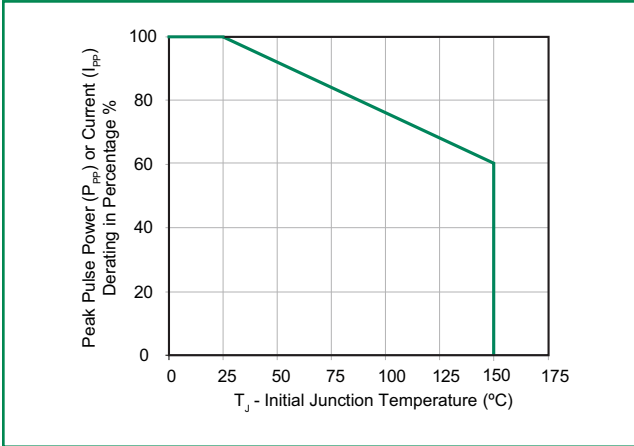

Figure 4 - Pulse Waveform

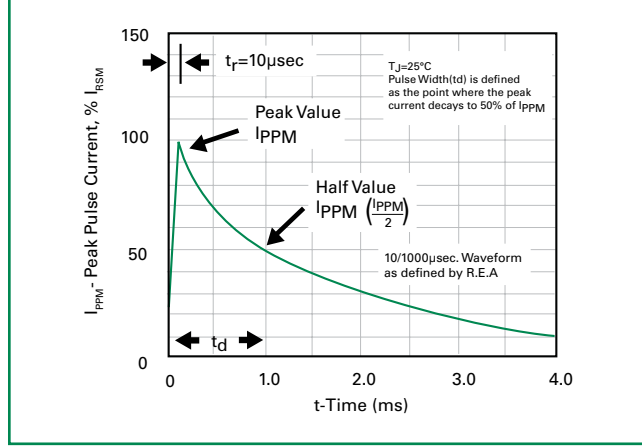

Figure 5 - Typical Junction Capacitance

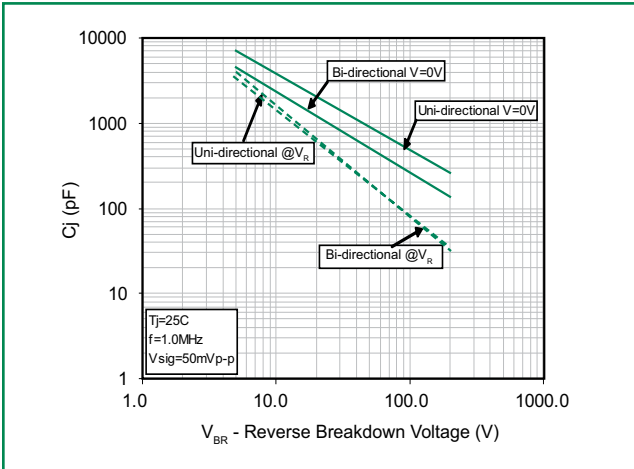

Figure 6 - Typical Transient Thermal Impedance

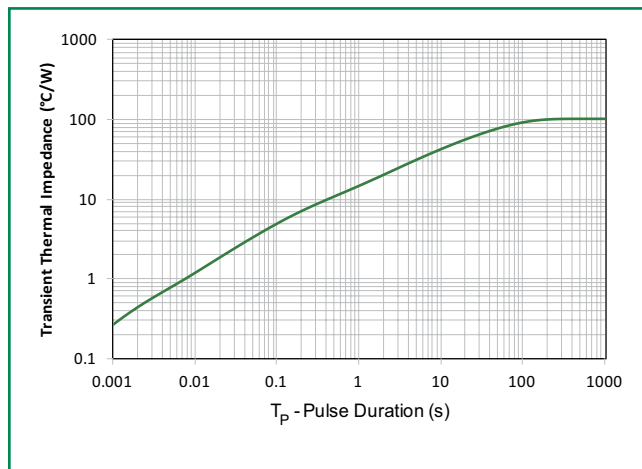

Figure 7 - Maximum Non-Repetitive Peak Forward Surge Current Uni-Directional Only

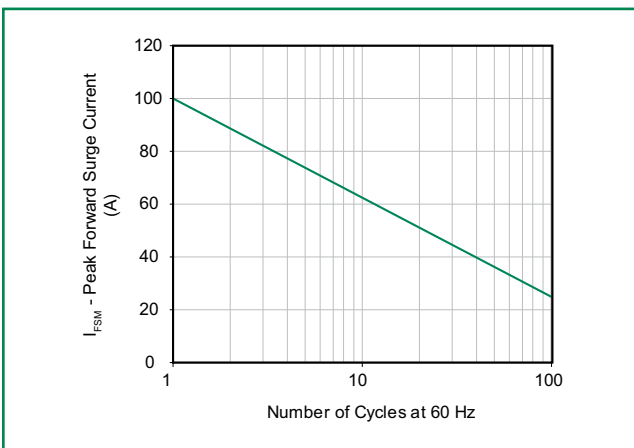
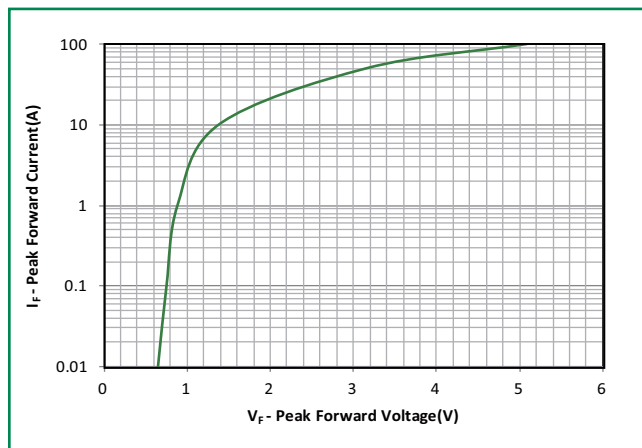

Figure 8 - Peak Forward Voltage Drop vs Peak Forward Current (Typical Values)



Soldering Parameters

Reflow Condition		Lead-free assembly
Pre Heat	- Temperature Min ($T_{s(min)}$)	150°C
	- Temperature Max ($T_{s(max)}$)	200°C
	- Time (min to max) (t_s)	60 – 180 secs
Average ramp up rate (Liquidus Temp (T_A) to peak)		3°C/second max
$T_{s(max)}$ to T_A - Ramp-up Rate		3°C/second max
Reflow	- Temperature (T_A) (Liquidus)	217°C
	- Time (min to max) (t_s)	60 – 150 seconds
Peak Temperature (T_p)		260 ^{+0/-5} °C
Time within 5°C of actual peak Temperature (t_p)		20 – 40 seconds
Ramp-down Rate		6°C/second max
Time 25°C to peak Temperature (T_p)		8 minutes Max.
Do not exceed		260°C



Physical Specifications

Weight	0.003 ounce, 0.093 grams
Case	JEDEC DO214AA. Molded plastic body over glass passivated junction
Polarity	Color band denotes cathode except Bidirectional.
Terminal	Matte Tin-plated leads, Solderable per JESD22-B102

Environmental Specifications

High Temp. Storage	JESD22-A103
HTRB	JESD22-A108
Temperature Cycling	JESD22-A104
MSL	JEDEC-J-STD-020, Level 1
H3TRB	JESD22-A101
RSH	JESD22-A111

Dimensions

DO-214AA (SMB J-Bend)



Dimensions	Inches		Millimeters	
	Min	Max	Min	Max
A	0.077	0.086	1.950	2.200
B	0.160	0.180	4.060	4.570
C	0.130	0.155	3.300	3.940
D	0.084	0.096	2.130	2.440
E	0.030	0.060	0.760	1.520
F	-	0.008	-	0.203
G	0.205	0.220	5.210	5.590
H	0.006	0.012	0.152	0.305
I	0.089	-	2.260	-
J	0.085	-	2.160	-
K	-	0.107	-	2.740
L	0.085	-	2.160	-

Part Numbering System



Part Marking System



Packaging

Part number	Component Package	Quantity	Packaging Option	Packaging Specification
1KSMBxxxXX	DO-214AA	3000	Tape & Reel - 12mm tape/13" reel	EIA STD RS-481

Tape and Reel Specification

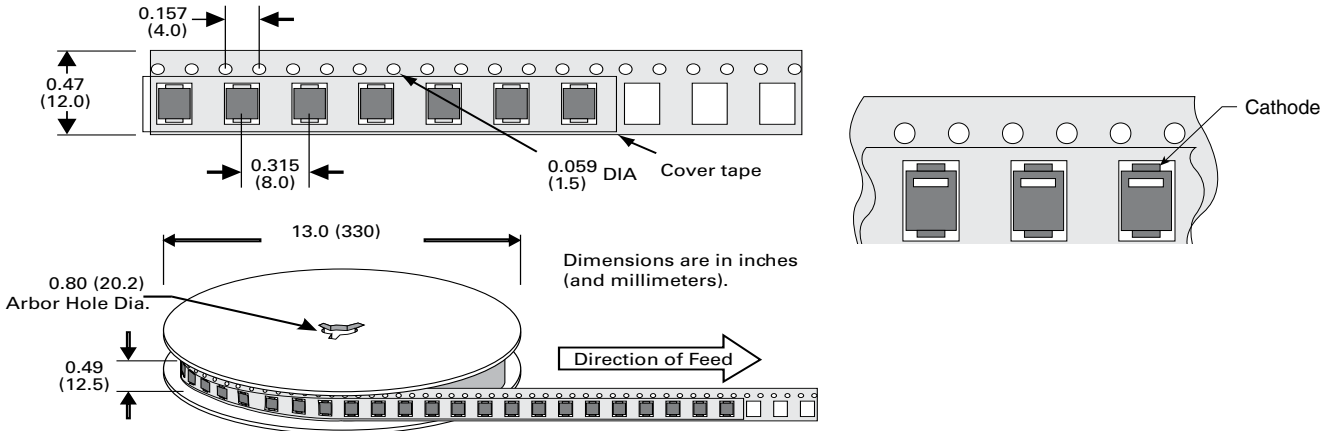

Looking for pricing, stock, or lifecycle information?

Click below to explore more details on WIN SOURCE:

 [View 1KSMB27A on WIN SOURCE](#)

 [Littelfuse Inc. Information](#)

Optimize Your Supply Chain with WIN SOURCE Solutions

-  Global Sourcing Solution
-  Obsolete Management
-  Cost Control Management
-  Shortage Management
-  Alternative Solution
-  Excess Inventory Management