



**THE DATASHEET OF
CAT3200HU2-GT3**



CAT3200HU2

Low Noise Regulated Charge Pump DC-DC Converter

Description

The CAT3200HU2 is a switched capacitor boost converter that delivers a low noise, regulated output voltage. The CAT3200HU2 gives a fixed regulated 5 V output when the FB pin is tied to ground, otherwise it provides an adjustable output using external resistors. The constant frequency 2 MHz charge pump allows small 1 μ F ceramic capacitors to be used.

Maximum output loads of up to 100 mA can be supported over a wide range of input supply voltages making the device ideal for battery-powered applications.

A shutdown control input allows the device to be placed in power-down mode, reducing the supply current to less than 1 μ A.

In the event of short circuit or overload conditions, the device is fully protected by both foldback current limiting and thermal overload detection. In addition, a soft start, slew rate control circuit limits inrush current during power-up.

The CAT3200HU2 is available in the tiny 8-pad UDFN 2 mm x 2 mm package.

Features

- Constant High Frequency (2 MHz) Operation
- 100 mA Output Current
- Regulated Output Voltage (5 V Fixed or Adjustable)
- Low Quiescent Current (1.7 mA Typ.)
- Soft Start, Slew Rate Control
- Reverse Leakage Protection
- Thermal Overload Shutdown Protection
- Low Value External Capacitors (1 μ F)
- Foldback Current Overload Protection
- Shutdown Current less than 1 μ A
- 8-pad UDFN 2 mm x 2 mm Package
- These Devices are Pb-Free, Halogen Free/BFR Free and are RoHS Compliant

Typical Applications

- 3 V to 5 V Boost Conversion
- 2.5 V to 3.3 V Boost Conversion
- White LED Driver
- Handheld Portable Devices



ON Semiconductor®

<http://onsemi.com>



UDFN-8
HU2 SUFFIX
CASE 517AW

MARKING DIAGRAM

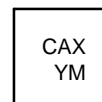

CA = Product Name
X = Assembly Location
Y = Production Year (Last Digit)
M = Production Month (1–9, O, N, D)

PIN CONNECTIONS

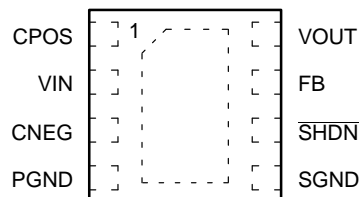

(Top View)

ORDERING INFORMATION

See detailed ordering and shipping information in the package dimensions section on page 2 of this data sheet.

CAT3200HU2

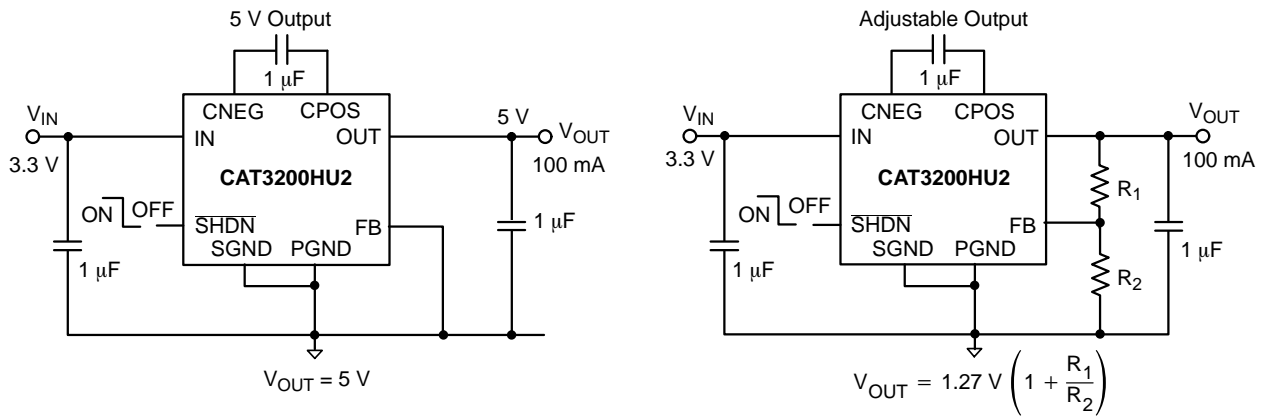

Figure 1. Typical Application Circuits

Table 1. ORDERING INFORMATION

Orderable Part Number	Output Voltage	Package	Lead Finish	Shipping (Note 1)
CAT3200HU2-GT3	5 V and Adjustable	UDFN-8	NiPdAu	3,000

1. For information on tape and reel specifications, including part orientation and tape sizes, please refer to our Tape and Reel Packaging Specifications Brochure, BRD8011/D.

Table 2. PIN FUNCTION DESCRIPTION

Pin No.	Pin Name	Description
1	CPOS	Positive connection for the flying capacitor
2	VIN	Input power supply
3	CNEG	Negative connection for the flying capacitor
4	PGND	Power ground
5	SGND	Ground reference for all voltages
6	SHDN	Shutdown control logic input (Active LOW)
7	FB	Feedback to set the output voltage
8	VOUT	Regulated output voltage
	Tab	Connect to ground on PCB

Table 3. ABSOLUTE MAXIMUM RATINGS

Rating	Value	Unit
V _{IN} , V _{FB} , SHDN, C _{NEG} , C _{POS} Voltage	-0.6 to +6	V
V _{OUT}	-0.6 to +7	V
V _{OUT} Short Circuit Duration	Indefinite	
Output Current	200	mA
ESD Protection (HBM)	2000	V
Junction Temperature Range	150	°C
Storage Temperature Range	-65 to +160	°C
Lead Soldering Temperature (10 sec)	300	°C

Stresses exceeding those listed in the Maximum Ratings table may damage the device. If any of these limits are exceeded, device functionality should not be assumed, damage may occur and reliability may be affected.

CAT3200HU2

Table 4. RECOMMENDED OPERATING CONDITIONS

Parameter	Conditions	Symbol	Min	Typ	Max	Unit
Input Voltage	5 V output	V_{IN}	2.7		4.5	V
	3.3 V adjustable output		2.2		3.0	V
C_{IN} , C_{OUT} , C_{FLY} (Note 2)			1.0	2.2	4.7	μF
Load Current		I_{LOAD}			100	mA
Ambient Temperature Range		T_{AMB}	-40		85	$^{\circ}C$

Functional operation above the stresses listed in the Recommended Operating Ranges is not implied. Extended exposure to stresses beyond the Recommended Operating Ranges limits may affect device reliability.

2. Refer to the Application Information section of this datasheet for more details.

Table 5. ELECTRICAL CHARACTERISTICS

(Recommended operating conditions unless otherwise specified. C_{IN} , C_{OUT} , C_{FLY} are 1 μF ceramic capacitors and V_{IN} is set to 3.6 V.)

Parameter	Conditions	Symbol	Min	Typ	Max	Units
Regulated Output	$I_{LOAD} \leq 40 \text{ mA}$, $V_{IN} \geq 2.7 \text{ V}$, $V_{FB} = 0 \text{ V}$	V_{OUT}	4.8	5.0	5.2	V
	$I_{LOAD} \leq 100 \text{ mA}$, $V_{IN} \geq 3.1 \text{ V}$, $V_{FB} = 0 \text{ V}$					
Line Regulation	$3.1 \text{ V} \leq V_{IN} \leq 4.5 \text{ V}$, $I_{LOAD} = 50 \text{ mA}$, $V_{FB} = 0 \text{ V}$	V_{LINE}		6		mV
Load Regulation	$I_{LOAD} = 10 \text{ mA to } 100 \text{ mA}$, $V_{IN} = 3.6 \text{ V}$, $V_{FB} = 0 \text{ V}$	V_{LOAD}		20		mV
Switching Frequency		F_{OSC}	1.3	2.0	2.6	MHz
Output Ripple Voltage	$I_{LOAD} = 100 \text{ mA}$, $V_{OUT} = 5 \text{ V}$, $C_{OUT} = 1 \mu F$, excluding ESR on C_{OUT} and PCB	V_R	25	30	45	mVp-p
Efficiency	$I_{LOAD} = 50 \text{ mA}$, $V_{IN} = 3 \text{ V}$, $V_{OUT} = 5 \text{ V}$	η	77	81	85	%
Ground Current	$I_{LOAD} = 0 \text{ mA}$, $\overline{SHDN} = V_{IN}$	I_{GND}		1.6	4	mA
Shutdown Input Current	$I_{LOAD} = 0 \text{ mA}$, $SHDN = 0 \text{ V}$	I_{SHDN}			1	μA
FB Voltage	Adjustable output only	V_{FB}	1.22	1.27	1.32	V
FB Input Current		I_{FB}	-50		50	nA
Open-Loop Resistance	$I_{LOAD} = 100 \text{ mA}$, $V_{IN} = 3 \text{ V}$	R_{OL}		10		Ω
V_{OUT} Turn-on time (10% to 90%)	$I_{LOAD} = 0 \text{ mA}$, $V_{IN} = 3 \text{ V}$	T_{ON}		0.5		ms
SHDN Logic High Level		V_{IH}	1.3			V
SHDN Logic Low Level		V_{IL}			0.4	V
Reverse Leakage into OUT pin	$V_{OUT} = 5 \text{ V}$, Shutdown mode, $V_{IN} = 3.0 \text{ V}$	I_{ROUT}		15	30	μA
Reverse Leakage from IN pin	$V_{OUT} = 5 \text{ V}$, Shutdown mode, $V_{IN} = 3.0 \text{ V}$	I_{RIN}			1	μA
Short-circuit Output	$V_{OUT} = 0 \text{ V}$	I_{SC}		80		mA
Thermal Shutdown		T_{SD}		160		$^{\circ}C$
Thermal Hysteresis		T_{HYST}		20		$^{\circ}C$

Product parametric performance is indicated in the Electrical Characteristics for the listed test conditions, unless otherwise noted. Product performance may not be indicated by the Electrical Characteristics if operated under different conditions.

CAT3200HU2

TYPICAL PERFORMANCE CHARACTERISTICS

($V_{IN} = 3.3\text{ V}$, $V_{FB} = \text{GND}$ (5 V output), $C_{IN} = C_{OUT} = C_{FLY} = 1\ \mu\text{F}$, [C0805C105K9RACTU], $T_{AMB} = 25^\circ\text{C}$)

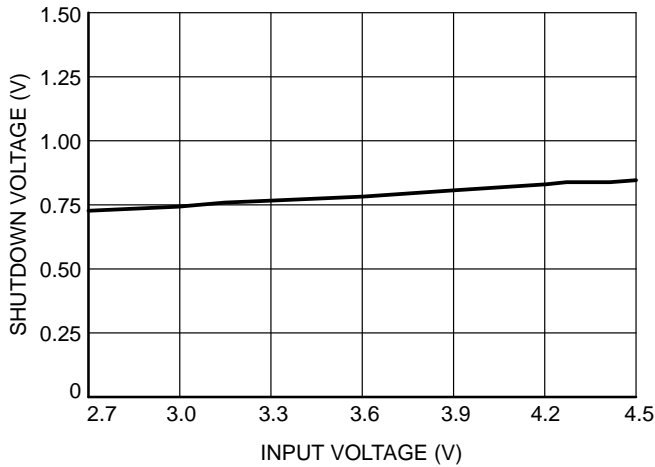

Figure 2. Shutdown Input Threshold vs. Input Voltage

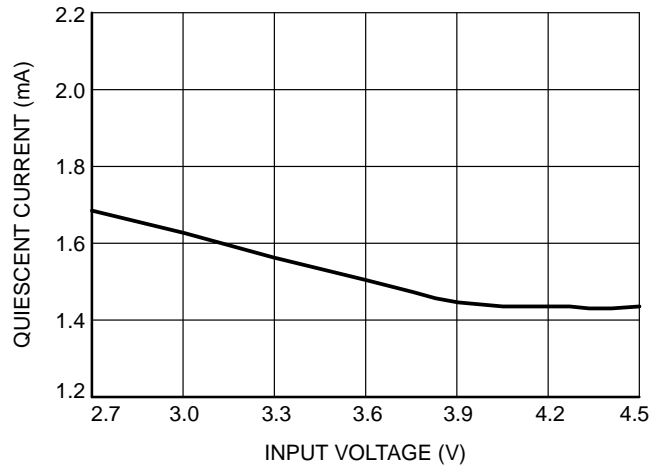

Figure 3. Quiescent Current vs. Input Voltage (No Load)

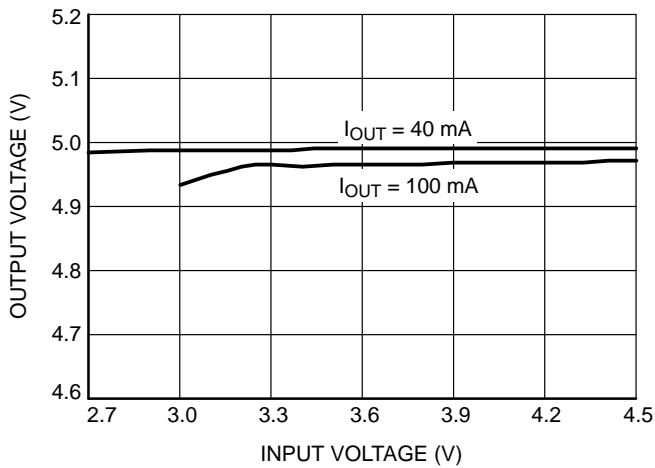

Figure 4. Output Voltage vs. Input Voltage

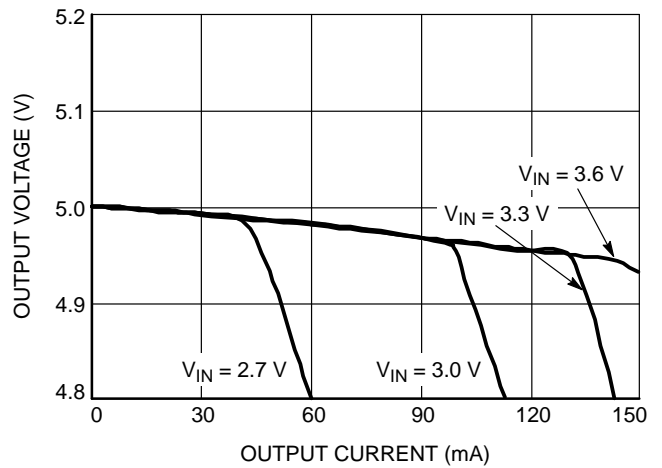

Figure 5. Output Voltage vs. Output Current

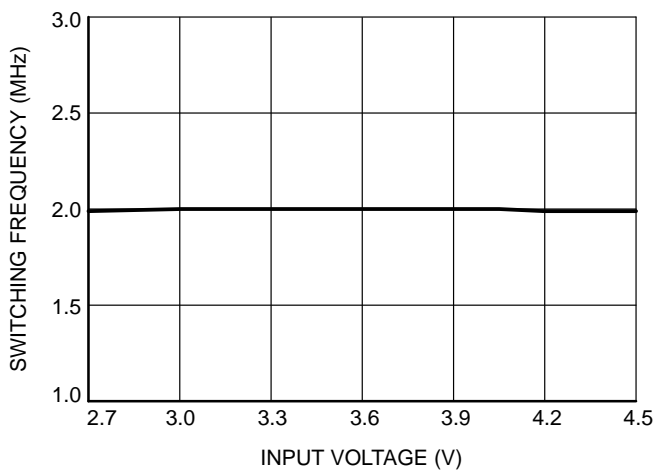

Figure 6. Oscillator Frequency vs. Input Voltage

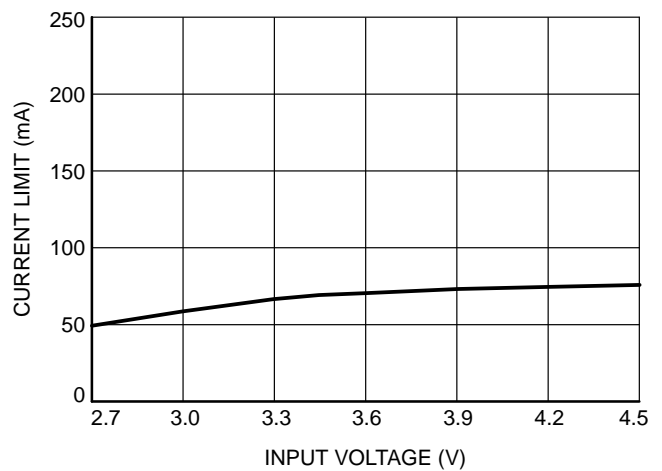

Figure 7. Short Circuit Current vs. Input Voltage

CAT3200HU2

TYPICAL PERFORMANCE CHARACTERISTICS

($V_{IN} = 3.3\text{ V}$, $V_{FB} = \text{GND}$ (5 V output), $C_{IN} = C_{OUT} = C_{FLY} = 1\ \mu\text{F}$, [C0805C105K9RACTU], $T_{AMB} = 25^\circ\text{C}$)

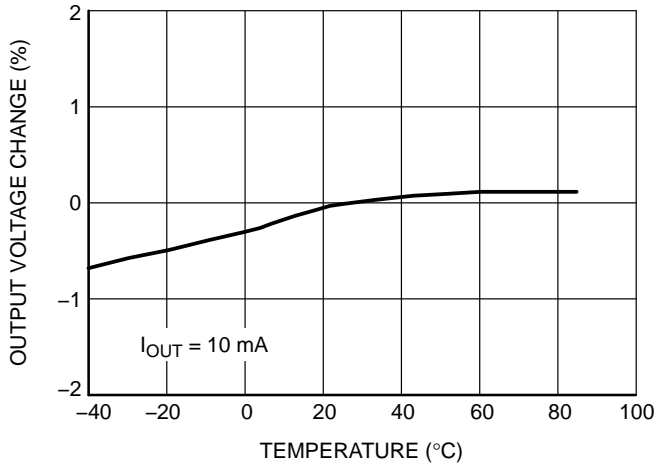

Figure 8. Output Voltage Change vs. Temperature

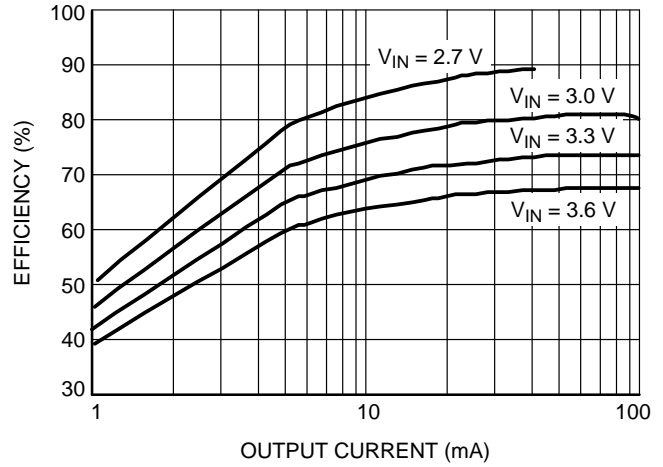

Figure 9. Efficiency vs. Output Current

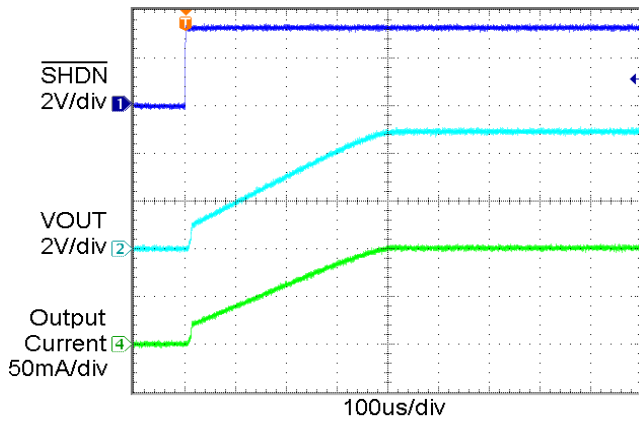

Figure 10. Power Up Waveform ($I_{OUT} = 100\text{ mA}$)

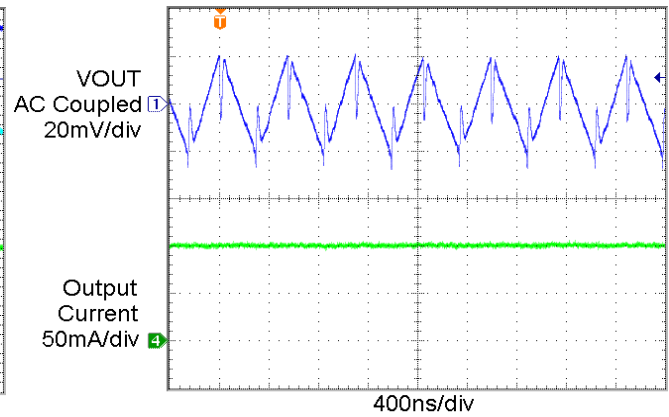

Figure 11. Output Ripple Voltage ($I_{OUT} = 100\text{ mA}$)

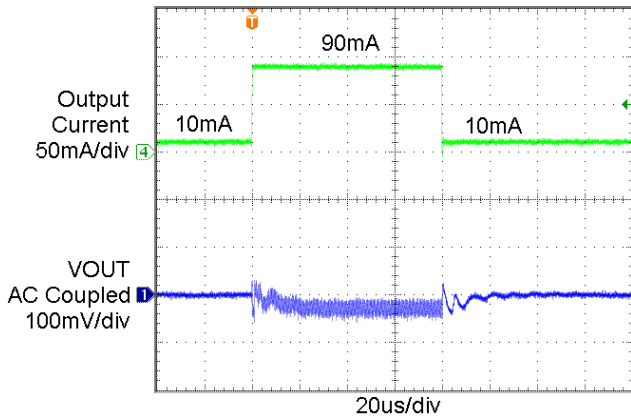

Figure 12. Load Transient Response

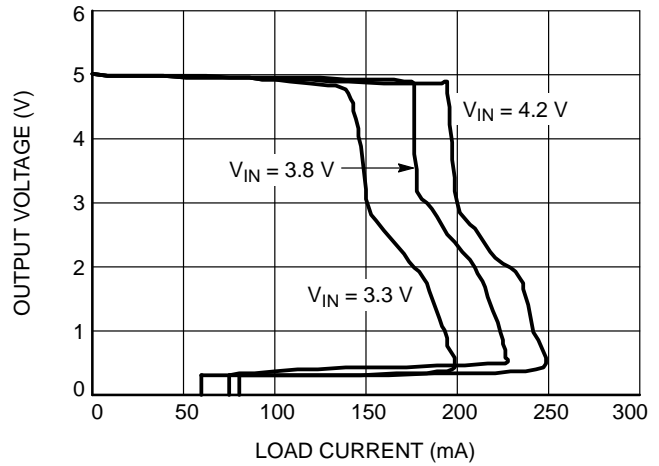

Figure 13. Foldback Current Limit

CAT3200HU2

TYPICAL PERFORMANCE CHARACTERISTICS

($V_{IN} = 2.5\text{ V}$, $V_{OUT} = 3.3\text{ V}$ (adjustable output), $R1 = 16\text{ k}\Omega$, $R2 = 10\text{ k}\Omega$, $C_{IN} = C_{OUT} = C_{FLY} = 1\text{ }\mu\text{F}$, [C0805C105K9RACTU], $T_{AMB} = 25^\circ\text{C}$)

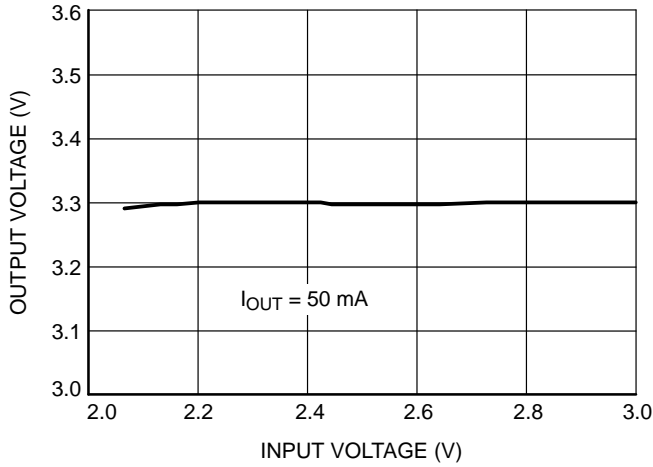

Figure 14. Output Voltage vs. Input Voltage

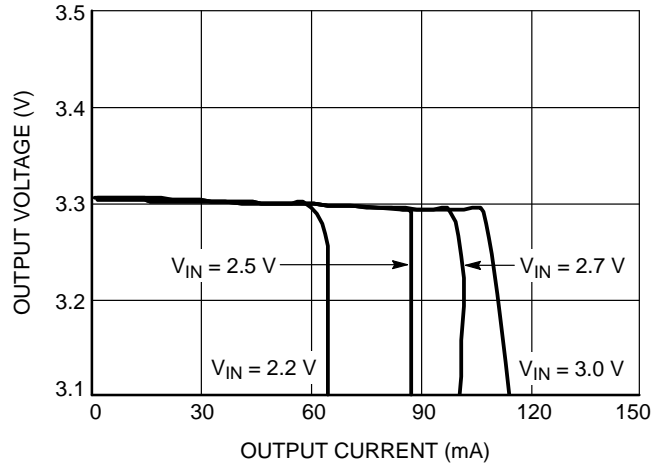

Figure 15. Output Voltage vs. Output Current

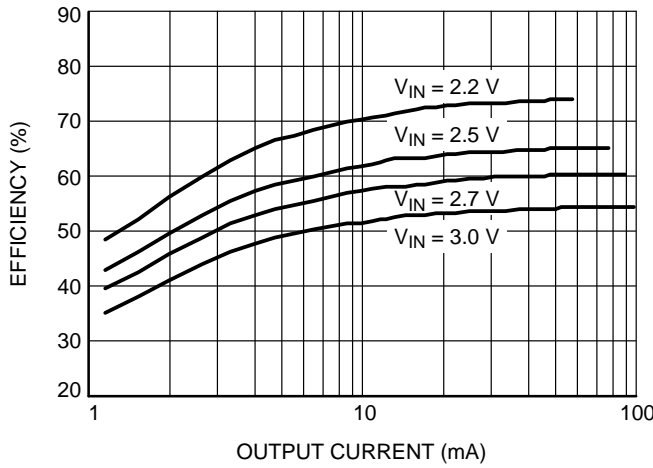

Figure 16. Efficiency vs. Output Current

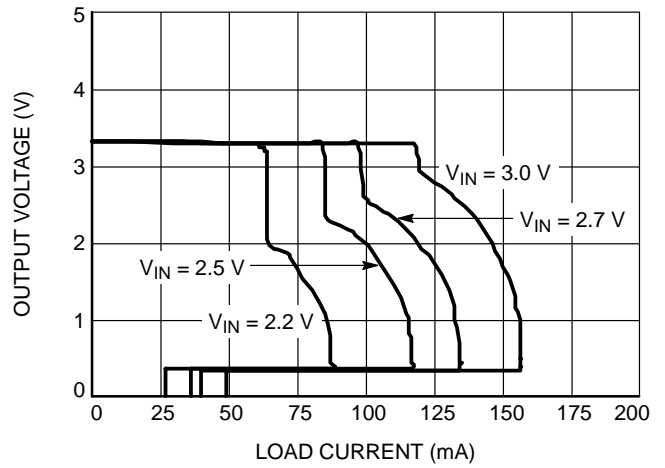

Figure 17. Foldback Current Limit

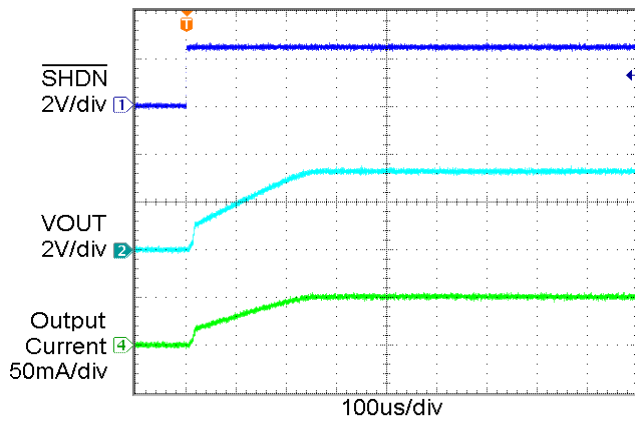

Figure 18. Power Up Waveform ($I_{OUT} = 50\text{ mA}$)

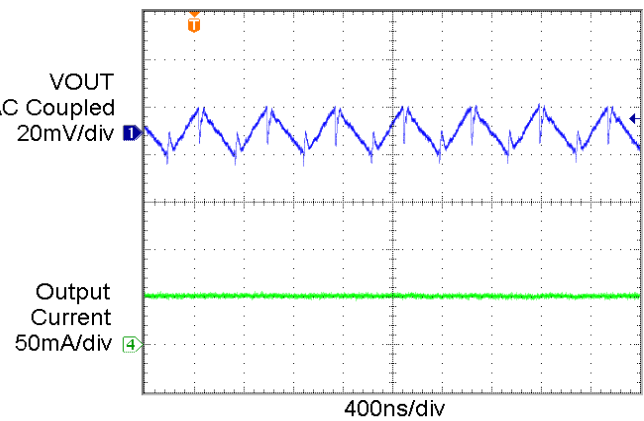

Figure 19. Output Ripple Voltage ($I_{OUT} = 50\text{ mA}$)

CAT3200HU2

Pin Functions

VIN is the power supply. During normal operation the device draws a supply current which is almost constant. A very brief interval of non-conduction will occur at the switching frequency. The duration of the non-conduction interval is set by the internal non-overlapping “break-before-make” timing. VIN should be bypassed with a 1 µF to 4.7 µF low ESR (Equivalent Series Resistance) ceramic capacitor.

For filtering, a low ESR ceramic bypass capacitor (1 µF) in close proximity to the IN pin prevents noise from being injected back into the power supply.

SHDN is the logic control input (active low) that places the device into shutdown mode. The internal logic is CMOS and the pin does not use an internal pull-down resistor. The SHDN pin should not be allowed to float.

CPOS, **CNEG** pins are the positive and negative connections respectively for the charge pump flying capacitor. A low ESR ceramic capacitor (1 µF) should be connected between these pins. During initial power-up it may be possible for the capacitor to experience a voltage reversal and for this reason, avoid using a polarized (tantalum or aluminum) flying capacitor.

VOUT is the regulated output voltage to power the load. During normal operation, the device will deliver a train of current pulses to the pin at a frequency of 2 MHz. Adequate filtering on the pin can typically be achieved through the use of a low ESR ceramic bypass capacitor (1 µF to 4.7 µF) in close proximity to the VOUT pin. The ESR of the output capacitor will directly influence the output ripple voltage.

When the shutdown mode is entered, the output is immediately isolated from the input supply, however, the output will remain connected to the internal feedback resistor network (400 kΩ). The feedback network will result in a reverse current of 10 µA to 20 µA to flow back through the device to ground.

Whenever the device is taken out of shutdown mode, the output voltage will experience a slew rate controlled power-up. Full operating voltage is typically achieved in less than 0.5 ms.

SGND is the ground reference for all voltages on the CAT3200HU2.

FB is the feedback input pin. An output divider should be connected from VOUT to FB to program the output voltage when used in adjustable output mode. When used in 5 V fixed output mode, connect the FB pin directly to GND.

PGND is the power ground.

Device Operation

The CAT3200HU2 uses a switched capacitor charge pump to boost the voltage at IN to a regulated output voltage. Regulation is achieved by sensing the output voltage through an internal resistor divider (FB pin = GND) and modulating the charge pump output current based on the

error signal. A 2-phase non-overlapping clock activates the charge pump switches. The flying capacitor is charged from the IN voltage on the first phase of the clock. On the second phase of the clock it is stacked in series with the input voltage and connected to VOUT. The charging and discharging of the flying capacitor continues at a free running frequency of typically 2 MHz.

In shutdown mode all circuitry is turned off and the CAT3200HU2 draws only leakage current from the VIN supply. VOUT is disconnected from VIN. The SHDN pin is a CMOS input with a threshold voltage of approximately 0.8 V. The CAT3200HU2 is in shutdown when a logic LOW is applied to the SHDN pin. The SHDN pin is a high impedance CMOS input. SHDN does not have an internal pull-down resistor and should not be allowed to float. It must always be driven with a valid logic level.

Short-Circuit and Thermal Protection

The CAT3200HU2 has built-in short-circuit current limiting and over temperature protection. During overload conditions, output current is limited to approximately 225 mA. At higher temperatures, or if the input voltage is high enough to cause excessive chip self heating, the thermal shutdown circuit shuts down the charge pump as the junction temperature exceeds approximately 160°C. Once the junction temperature drops back to approximately 140°C, the charge pump is enabled. The CAT3200HU2 will cycle in and out of thermal shutdown indefinitely without latch-up or damage until a short-circuit on VOUT is removed.

Programming the CAT3200HU2 Output Voltage (FB Pin)

The CAT3200HU2 version has an internal resistive divider to program the output voltage. The programmable CAT3200HU2 may be set to an arbitrary voltage via an external resistive divider. Since it employs a voltage doubling charge pump, it is not possible to achieve output voltages greater than twice the available input voltage. Figure 20 shows the required voltage divider connection. The voltage divider ratio is given by the formula:

$$\frac{R1}{R2} = \frac{V_{OUT}}{1.27 V} - 1$$

Typical values for total voltage divider resistance can range from several kΩ up to 1 MΩ.

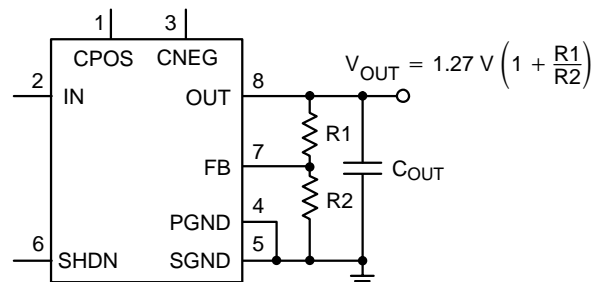

Figure 20. Programming the Adjustable Output

Application Information

Ceramic Capacitors

Ceramic capacitors of different dielectric materials lose their capacitance with higher temperature and voltage at different rates. For example, a capacitor made of X5R or X7R material will retain most of its capacitance from -40°C to 85°C whereas a Z5U or Y5V style capacitor will lose considerable capacitance over that range.

Z5U and Y5V capacitors may also have voltage coefficient causing them to lose 60% or more of their capacitance when the rated voltage is applied. When comparing different capacitors it is often useful to consider the amount of achievable capacitance for a given case size rather than discussing the specified capacitance value. For example, over rated voltage and temperature conditions, a $1\ \mu\text{F}$, 10 V, Y5V ceramic capacitor in an 0603 case may not provide any more capacitance than a $0.22\ \mu\text{F}$, 10 V, X7R available in the same 0603 case. For many CAT3200HU2 applications these capacitors can be considered roughly equivalent.

Output Ripple

The output ripple voltage is related to the output capacitor size C_{OUT} and ESR (equivalent series resistance) and can be calculated using the formula below:

$$V_R = I_{\text{LOAD}} / (2 \cdot F_{\text{OSC}} \cdot C_{\text{OUT}}) + 2 \cdot \text{ESR}_{\text{COUT}} \cdot I_{\text{LOAD}}$$

where F_{OSC} is the switching frequency.

Efficiency

The efficiency is basically set by the ratio between the input voltage V_{IN} and the output voltage V_{OUT} , and can be calculated using the formula below:

$$\begin{aligned} \text{Efficiency [\%]} &= 100 \cdot P_{\text{OUT}} / P_{\text{IN}} \\ &= 100 \cdot V_{\text{OUT}} \cdot I_{\text{LOAD}} / (V_{\text{IN}} \cdot I_{\text{IN}}) \end{aligned}$$

where F_{OSC} is the switching frequency, and

$$I_{\text{IN}} = I_{\text{GND}} + 2 \cdot I_{\text{LOAD}}$$

If we neglect the Ground current (I_{GND}), then the efficiency is basically equal to:

$$\text{Efficiency [\%]} \cong 100 \cdot V_{\text{OUT}} / (2 \cdot V_{\text{IN}})$$

Layout Guidance

The CAT3200HU2 2 MHz switching frequency requires minimum trace length and impedance for C_{IN} , C_{OUT} , and C_{FLY} capacitors. This can be accomplished by placing these components close to the IC. The C_{IN} capacitor ground connection can connect directly to PGND and a wide, single trace should connect PGND and SGND. C_{OUT} should be star-connected to SGND, along with FB resistor network, if used.

CAT3200HU2

PACKAGE DIMENSIONS

UDFN8, 2x2
CASE 517AW-01
ISSUE O

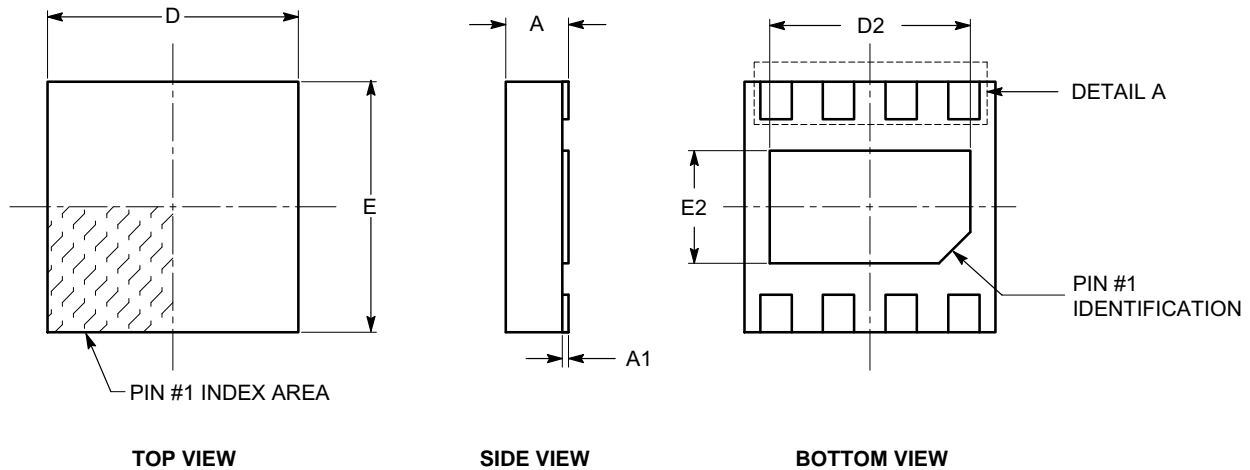

SYMBOL	MIN	NOM	MAX
A	0.45	0.50	0.55
A1	0.00	0.02	0.05
b	0.18	0.25	0.30
D	1.90	2.00	2.10
D2	1.50	1.60	1.70
E	1.90	2.00	2.10
E2	0.80	0.90	1.00
e	0.50 BSC		
L	0.20	0.30	0.45

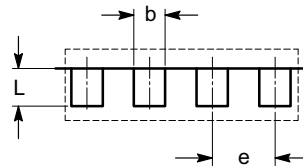

DETAIL A

Notes:

- (1) All dimensions are in millimeters.
- (2) Complies with JEDEC MO-229.

ON Semiconductor and the  are registered trademarks of Semiconductor Components Industries, LLC (SCILLC) or its subsidiaries in the United States and/or other countries. SCILLC owns the rights to a number of patents, trademarks, copyrights, trade secrets, and other intellectual property. A listing of SCILLC's product/patent coverage may be accessed at www.onsemi.com/site/pdf/Patent-Marking.pdf. SCILLC reserves the right to make changes without further notice to any products herein. SCILLC makes no warranty, representation or guarantee regarding the suitability of its products for any particular purpose, nor does SCILLC assume any liability arising out of the application or use of any product or circuit, and specifically disclaims any and all liability, including without limitation special, consequential or incidental damages. "Typical" parameters which may be provided in SCILLC data sheets and/or specifications can and do vary in different applications and actual performance may vary over time. All operating parameters, including "Typicals" must be validated for each customer application by customer's technical experts. SCILLC does not convey any license under its patent rights nor the rights of others. SCILLC products are not designed, intended, or authorized for use as components in systems intended for surgical implant into the body, or other applications intended to support or sustain life, or for any other application in which the failure of the SCILLC product could create a situation where personal injury or death may occur. Should Buyer purchase or use SCILLC products for any such unintended or unauthorized application, Buyer shall indemnify and hold SCILLC and its officers, employees, subsidiaries, affiliates, and distributors harmless against all claims, costs, damages, and expenses, and reasonable attorney fees arising out of, directly or indirectly, any claim of personal injury or death associated with such unintended or unauthorized use, even if such claim alleges that SCILLC was negligent regarding the design or manufacture of the part. SCILLC is an Equal Opportunity/Affirmative Action Employer. This literature is subject to all applicable copyright laws and is not for resale in any manner.

PUBLICATION ORDERING INFORMATION

LITERATURE FULFILLMENT:
Literature Distribution Center for ON Semiconductor
P.O. Box 5163, Denver, Colorado 80217 USA
Phone: 303-675-2175 or 800-344-3860 Toll Free USA/Canada
Fax: 303-675-2176 or 800-344-3867 Toll Free USA/Canada
Email: orderlit@onsemi.com

N. American Technical Support: 800-282-9855 Toll Free USA/Canada
Europe, Middle East and Africa Technical Support:
Phone: 421 33 790 2910
Japan Customer Focus Center
Phone: 81-3-5817-1050

ON Semiconductor Website: www.onsemi.com
Order Literature: <http://www.onsemi.com/orderlit>
For additional information, please contact your local Sales Representative

Looking for pricing, stock, or lifecycle information?

Click below to explore more details on WIN SOURCE:

 [View CAT3200HU2-GT3 on WIN SOURCE](#)

 [ON Semiconductor](#) Information

Optimize Your Supply Chain with WIN SOURCE Solutions

-  Global Sourcing Solution
-  Obsolete Management
-  Cost Control Management
-  Shortage Management
-  Alternative Solution
-  Excess Inventory Management