



**THE DATASHEET OF
AS1358-BTTT-28**



AS1358/AS1359

150mA/300mA, Ultra-Low-Noise, High-PSRR Low Dropout Regulators

1 General Description

The AS1358/AS1359 are ultra-low-noise, low-dropout linear regulators specifically designed to deliver up to 150/300mA continuous output current, and can achieve a low 140mV dropout for 300mA load current. The LDOs are designed and optimized to work with low-cost, small-capacitance ceramic capacitors.

The devices are available as the standard products listed in [Table 1](#).

Table 1. Standard Products

Model	Load Current	Output Voltage
AS1358	150mA	Preset – 1.5 to 4.5V
AS1359	300mA	Preset – 1.5 to 4.5V

An integrated P-channel MOSFET pass transistor allows the devices to maintain extremely low quiescent current (40µA).

The AS1358/AS1359 uses an advanced architecture to achieve ultra-low output voltage noise of 9µVRMS and a power-supply rejection-ratio of better than 80dB (up to 10kHz).

The AS1358/AS1359 requires only 1µF output capacitor for stability at any load. When the LDO is disabled, current consumption drops below 500nA.

The devices are available in a TSOT23 5-pin package.

2 Key Features

- Preset Output Voltages: 1.5 to 4.5V (in 50mV steps)
- Output Noise: 9µVRMS @ 100Hz to 100kHz
- Power-Supply Rejection Ratio: 92dB @ 1kHz
- Low Dropout: 140mV @ 300mA Load
- Stable with 1µF Ceramic Capacitor for any Load
- Guaranteed 150/300mA Output
- 1.25V Internal Reference
- Extremely-Low Quiescent Current: 40µA
- Excellent Load/Line Transient
- Overcurrent and Thermal Protection
- TSOT23 5-pin Package

3 Applications

The devices are ideal for mobile phones, wireless phones, PDAs, handheld computers, mobile phone base stations, Bluetooth portable radios and accessories, wireless LANs, digital cameras, personal audio devices, and any other portable, battery-powered application.

Figure 1. Typical Application Circuit

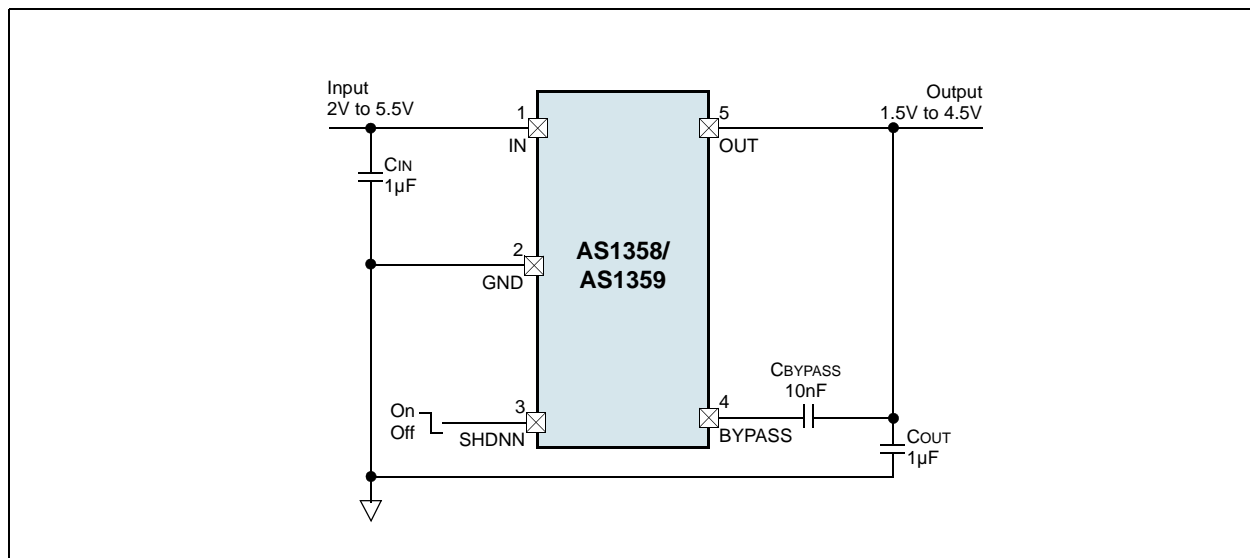

4 Pinout

Pin Assignments

Figure 2. Pin Assignments (Top View)

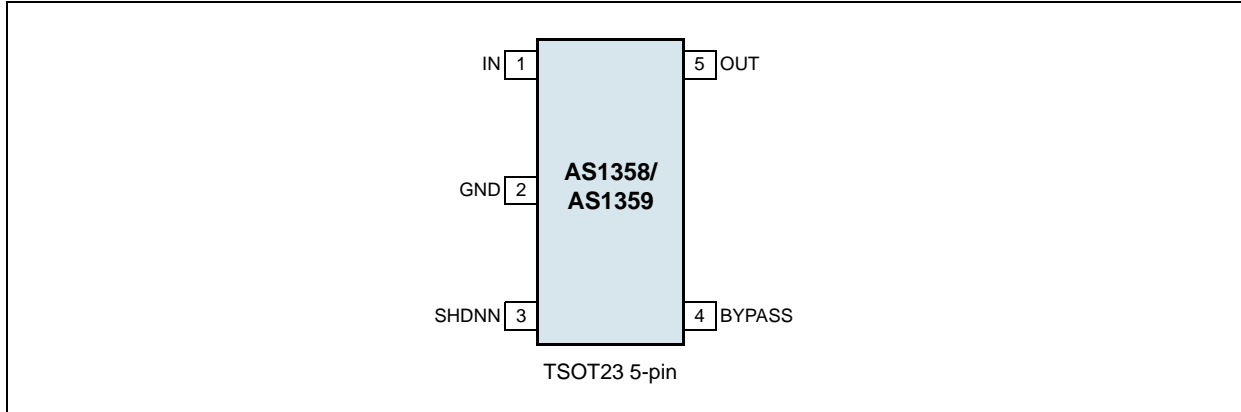

Pin Descriptions

Table 2. Pin Descriptions

Pin Number	Pin Name	Description
1	IN	Unregulated Input Supply.
2	GND	Ground
3	SHDNN	Shutdown. Pull this pin low to disable the LDO.
4	BYPASS	Noise Bypass for Low-Noise Operation. Connect a 10nF capacitor from this pin to OUT . Note: This pin is shorted to GND in shutdown mode.
5	OUT	Regulated Output Voltage. Bypass this pin with a capacitor to GND. See Capacitor Selection and Regulator Stability on page 11 for more details.

5 Absolute Maximum Ratings

Stresses beyond those listed in [Table 3](#) may cause permanent damage to the device. These are stress ratings only, and functional operation of the device at these or any other conditions beyond those indicated in [Electrical Characteristics on page 4](#) is not implied. Exposure to absolute maximum rating conditions for extended periods may affect device reliability.

Table 3. Absolute Maximum Ratings

Parameter	Min	Max	Units	Comments
IN to GND	-0.3	+7	V	
OUT, SHDNN to GND	-0.3	IN + 0.3	V	
BYPASS to GND	-0.3	OUT + 0.3	V	
Output Short-Circuit Duration		Infinite		
Thermal Resistance Θ_{JA}		201.7	°C/W	on PCB
Operating Temperature Range	-40	+85	°C	
Junction Temperature		+150	°C	
Storage Temperature Range	-65	+150	°C	
Package Body Temperature		+260	°C	The reflow peak soldering temperature (body temperature) specified is in accordance with <i>IPC/JEDEC J-STD-020D "Moisture/Reflow Sensitivity Classification for Non-Hermetic Solid State Surface Mount Devices"</i> . The lead finish for Pb-free leaded packages is matte tin (100% Sn).

6 Electrical Characteristics

$V_{IN} = V_{OUT} + 0.5V$, $C_{IN} = 1\mu F$, $C_{OUT} = 1\mu F$, $C_{BYPASS} = 10nF$, $T_{AMB} = -40$ to $+85^{\circ}C$ (unless otherwise specified). Typ values are at $T_{AMB} = +25^{\circ}C$.

Table 4. Electrical Characteristics

Symbol	Parameter	Condition	Min	Typ	Max	Unit
V_{IN}	Input Voltage Range		2		5.5	V
	Output Voltage Accuracy	$I_{OUT} = 1mA$, $T_{AMB} = +25^{\circ}C$	-0.5		+0.5	%
		$I_{OUT} = 100\mu A$ to $150mA$, $T_{AMB} = +25^{\circ}C$ (AS1358)	-0.75		+0.75	
		$I_{OUT} = 100\mu A$ to $300mA$, $T_{AMB} = +25^{\circ}C$ (AS1359)	-1.0		+1.0	
		$I_{OUT} = 100\mu A$ to $150mA$, (AS1358)	-1.5		+1.5	
		$I_{OUT} = 100\mu A$ to $300mA$, (AS1359)	-2.0		+2.0	
I_{OUT}	Maximum Output Current	AS1358	150			mA
		AS1359	300			
I_{LIMIT}	Current Limit	AS1358, $O_{UT} = 90\%$ of nom., $T_{AMB} = +25^{\circ}C$		270		mA
		AS1359, $O_{UT} = 90\%$ of nom., $T_{AMB} = +25^{\circ}C$		510		
	Dropout Voltage ¹	$V_{OUT} \geq 3V$, $I_{OUT} = 150mA$		70	95	mV
		$V_{OUT} \geq 3V$, $I_{OUT} = 300mA$, (AS1359 only)		140	200	
		$2.5V \leq V_{OUT} < 3V$, $I_{OUT} = 150mA$		90	120	
		$2.5V \leq V_{OUT} < 3V$, $I_{OUT} = 300mA$, (AS1359 only)		170	230	
		$2.0V \leq V_{OUT} < 2.5V$, $I_{OUT} = 150mA$		140	190	
		$2.0V \leq V_{OUT} < 2.5V$, $I_{OUT} = 300mA$, (AS1359 only)		270	350	
I_Q	Quiescent Current	$I_{OUT} = 0.05mA$		40	90	μA
		$V_{IN} = V_{OUTNOM} - 0.1V$, $I_{OUT} = 0mA$		150	250	
V_{LNR}	Line Regulation	$V_{IN} = (V_{OUT} + 0.5V)$ to $5.5V$, $I_{OUT} = 0.1mA$		0.02		%/V
V_{LDR}	Load Regulation	$I_{OUT} = 1$ to $150/300mA$		0.0005		%/mA
I_{SHDNN}	Shutdown Supply Current	SHDNN = 0V		9	500	nA
PSRR	Ripple Rejection	$f = 1kHz$, $I_{OUT} = 10mA$		92		dB
		$f = 10kHz$, $I_{OUT} = 10mA$		80		
		$f = 100kHz$, $I_{OUT} = 10mA$		62		
	Output Noise Voltage (RMS)	$f = 100Hz$ to $100kHz$, $I_{LOAD} = 0$ to $150/300mA$		9		μV
Shutdown						
	Shutdown Exit Delay ²	$R_{LOAD} = 50\Omega$			300	μs
	SHDNN Logic Low Level	$V_{IN} = 2$ to $5.5V$			0.4	V
	SHDNN Logic High Level	$V_{IN} = 2$ to $5.5V$	1.5			V

Table 4. Electrical Characteristics (Continued)

Symbol	Parameter	Condition	Min	Typ	Max	Unit
Thermal Protection						
T _{SHDNM}	Thermal Shutdown Temperature			160		°C
Δ T _{SHDNM}	Thermal Shutdown Hysteresis			15		°C

1. Dropout is defined as $V_{IN} - V_{OUT}$ when V_{OUT} is 100mV below the value of V_{OUT} for $V_{IN} = V_{OUT} + 0.5V$

2. Time needed for V_{OUT} to reach 90% of final value.

Note: All limits are guaranteed. The parameters with min and max values are guaranteed with production tests or SQC (Statistical Quality Control) methods.

7 Typical Operating Characteristics

$V_{IN} = V_{OUT} + 0.5V$, $C_{IN} = C_{OUT} = 1\mu F$, $C_{BYPASS} = 10nF$, $T_{AMB} = 25^{\circ}C$ (unless otherwise specified).

Figure 3. Output Voltage vs. Input Voltage



Figure 4. Output Voltage Accuracy vs. Load Current



Figure 5. Output Voltage Accuracy vs. Temperature



Figure 6. Dropout Voltage vs. Load Current



Figure 7. Dropout Voltage vs. Output Voltage



Figure 8. Ground Pin Current vs. Input Voltage



Figure 9. Ground Pin Current vs. Load Current



Figure 10. Ground Pin Current vs. Temperature



Figure 11. PSRR vs. Frequency; IOUT = 10mA



Figure 12. Output Noise Spectral Density vs. Freq.

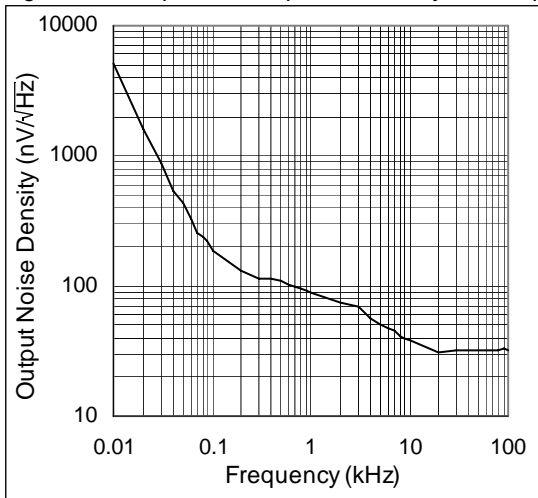

Figure 13. Output Noise vs. Bypass Capacitance

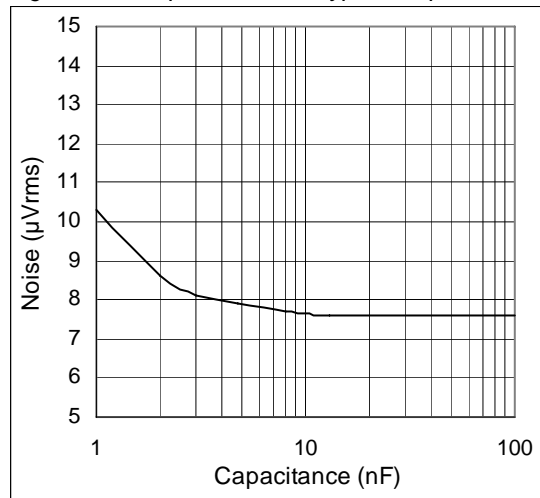

Figure 14. Load Transient Response,
 $V_{IN} = 3.8V$, $V_{OUT} = 3.3V$



Figure 15. Load Transient Response near Dropout,
 $V_{IN} = 3.4V$, $V_{OUT} = 3.3V$



Figure 16. Line Transient Response



Figure 17. Enter & Exit Shutdown Delay



8 Detailed Description

The AS1358/AS1359 are ultra-low-noise, low-dropout, low-quiescent current linear-regulators specifically designed for space-limited applications. The devices are available with preset output voltages from 1.5 to 4.5V in 50mV increments.

These devices can supply loads up to 150/300mA. As shown in [Figure 18](#), the AS1358/AS1359 consist of an integrated bandgap core and noise bypass circuitry, error amplifier, P-channel MOSFET pass transistor, and internal feedback voltage-divider.

The output voltage is fed back through an internal resistor voltage-divider connected to pin OUT. An external bypass capacitor connected to pin BYPASS reduces noise at the output. Additional blocks include a current limiter, thermal sensor, and shutdown logic.

Internal Voltage Reference

The 1.25V bandgap reference is connected to the error amplifier's inverting input. The error amplifier compares this reference with the feedback voltage and amplifies the difference. If the feedback voltage is lower than the reference voltage, the pass-transistor gate is pulled low. This allows more current to pass to the output and increases the output voltage. If the feedback voltage is too high, the pass transistor gate is pulled high, allowing less current to pass to the output.

Internal P-Channel Pass Transistor

The AS1358/AS1359 feature a 0.5 Ω (typ) P-channel MOSFET pass transistor, which provides several advantages over similar designs using a PNP pass transistor, including prolonged battery life. The P-channel MOSFET does not require a base driver, thus quiescent current is dramatically reduced. The AS1358/AS1359 LDOs do not exhibit problems associated with typical PNP-based LDOs, and consume only 40 μ A of quiescent current in light load and 220 μ A in dropout (see [Typical Operating Characteristics on page 6](#)).

Output Voltage

The AS1358/AS1359 deliver preset output voltages from 1.5 to 4.5V, in 50mV increments (see [Ordering Information on page 13](#)).

Shutdown

The AS1358/AS1359 feature a low-power shutdown mode that reduces quiescent current to <200nA. Driving SHDNN low disables the internal voltage reference, error amplifier, gate-drive circuitry, and P-channel MOSFET pass transistor (see [Figure 18](#)), and the device output enters a high-impedance state.

Note: For normal operation connect pin SHDNN to pin IN.

Figure 18. AS1358/AS1359 Block Diagram



Current Limit

The AS1358/AS1359 include a current limiting circuitry to monitor and control the P-channel MOSFET pass transistor's gate voltage, thus limiting the device output current to 270mA (AS1358) and 510mA (AS1359).

Note: See [Table 4 on page 4](#) for the recommended min and max current limits. The output can be shorted to ground indefinitely without causing damage to the device.

Thermal Protection

Integrated thermal protection circuitry limits total power dissipation in the AS1358/AS1359. When the junction temperature (T_J) exceeds +160°C, the thermal sensor signals the shutdown logic, turning off the P-channel MOSFET pass transistor and allowing the device to cool down. The thermal sensor turns the pass transistor on again after the device's junction temperature drops by 10°C, resulting in a pulsed output during continuous thermal-overload conditions.

Note: Thermal protection is designed to protect the devices in the event of fault conditions. For continuous operation, do not exceed the absolute maximum junction temperature rating of +150°C.

Operating Region and Power Dissipation

The AS1358/AS1359 maximum power dissipation is dependant on the thermal resistance of the case and PCB, the temperature difference between the die junction and T_{AMB} , and airflow rate.

Power dissipation across the device is calculated as:

$$PD = I_{OUT} (V_{IN} - V_{OUT}) \quad (EQ 1)$$

The maximum power dissipation is calculated:

$$PD_{MAX} = (T_J - T_{AMB}) / (\theta_{JC} + \theta_{CA}) \quad (EQ 2)$$

Where:

$T_J - T_{AMB}$ is the temperature difference between the AS1358/AS1359 die junction and the surrounding air;

θ_{JC} is the thermal resistance of the package;

θ_{CA} is the thermal resistance through the PC board/copper traces/other materials to the surrounding air.

Note: Pin GND of the AS1358/AS1359 provides the electrical connection to system ground and also serves as a heat sink. Connect pin GND to the system ground using a large pad or ground plane.

Noise Reduction

The AS1358/AS1359 noise bypass circuitry dramatically reduces output noise, exhibiting 9µVRMS of output voltage noise with $C_{BYPASS} = 0.01\mu F$ and $C_{OUT} = 1\mu F$. Use an external 0.01µF bypass capacitor between pin BYPASS and pin OUT (see [Figure 1 on page 1](#)).

Note: Startup time is minimized by internal power-on circuitry which pre-charges C_{BYPASS} .

9 Application Information

Capacitor Selection and Regulator Stability

For normal operation, use a 1 μ F capacitor at pin IN and a 1 μ F capacitor at pin OUT. Larger input capacitor values and lower ESR provide better noise rejection and line-transient response. Reduce output noise and improve load-transient response, stability, and power-supply rejection by using large output capacitors.

Note: Some ceramic dielectrics exhibit large capacitance and ESR variation with temperature. With dielectrics such as Z5U and Y5V, it may be necessary to use a 2.2 μ F or larger output capacitor to ensure stability at temperatures below -10°C. With X7R or X5R dielectrics, 1 μ F is sufficient at all operating temperatures.

Bypass Capacitor

Use a 0.01 μ F bypass capacitor at pin BYPASS for low-output voltage noise reduction. The leakage current going into pin BYPASS should be less than 10nA. Increasing the capacitance slightly decreases the output noise. Values above 0.1 μ F and below 0.001 μ F are not recommended.

Noise, PSRR, and Transient Response

The AS1358/AS1359 are designed to deliver ultra-low noise and high PSRR, as well as low dropout and low quiescent currents in battery-powered systems. The power-supply rejection is 92dB at 1kHz and 62dB at 100kHz. (see [PSRR vs. Frequency; IOUT = 10mA on page 7](#)).

When operating from sources other than batteries, improved supply-noise rejection and transient response can be achieved by increasing the values of the input and output capacitors, and through passive filtering techniques.

The [Figure 16](#) and [Figure 14 on page 8](#) show the AS1358/AS1359 line- and load-transient responses.

Dropout Voltage

The AS1358/AS1359 minimum dropout voltage determines the lowest usable supply voltage. In battery-powered systems, this determines the useful end-of-life battery voltage.

Since the AS1358/AS1359 use a P-channel MOSFET pass transistor, the dropout voltage is a function of drain-to-source on-resistance ($R_{DS(ON)}$) multiplied by I_{LOAD} (see [Figure 6 on page 6](#)).

10 Package Drawings and Markings

The devices are available in a TSOT23 5-pin package.

Figure 19. TSOT23 5-pin Package



Symbol	Min	Typ	Max	Notes	Symbol	Min	Typ	Max	Notes
A			1.00		L	0.30	0.40	0.50	
A1	0.01	0.05	0.10		L1	0.60REF			
A2	0.84	0.87	0.90		L2	0.25BSC			
b	0.30		0.45		N		5		
b1	0.31	0.35	0.39		R	0.10			
c	0.12	0.15	0.20		R1	0.10		0.25	
c1	0.08	0.13	0.16		θ	0°	4°	8°	
D		2.90BSC		3,4	θ1	4°	10°	12°	
E		2.80BSC		3,4	Tolerances of Form and Position				
E1		1.60BSC		3,4	aaa		0.15		
e		0.95BSC			bbb		0.25		
e1		1.90BSC			ccc		0.10		
					ddd		0.20		

Notes:

1. Dimensioning and tolerancing conform to ASME Y14.5M - 1994.
2. Dimensions are in millimeters.
3. Dimension D does not include mold flash, protrusions, or gate burrs. Mold flash, protrusions, and gate burrs shall not exceed 0.15mm per end. Dimension E1 does not include interlead flash or protrusion. Interlead flash or protrusion shall not exceed 0.15mm per side. Dimensions D and E1 are determined at datum H.
4. The package top can be smaller than the package bottom. Dimensions D and E1 are determined at the outermost extremes of the plastic body exclusive of mold flash, tie bar burrs, gate burrs, and interlead flash, but include any mismatches between the top of the package body and the bottom. D and E1 are determined at datum H.

11 Ordering Information

The devices are available as the standard products shown in [Table 5](#).

Table 5. Ordering Information

Ordering Code	Marking	Output Current	Output Voltage	Delivery Form	Package
AS1358-BTTT-15	ASLI	150mA	1.5V	Tape and Reel	TSOT23 5-pin
AS1358-BTTT-18	ASLJ	150mA	1.8V	Tape and Reel	TSOT23 5-pin
AS1358-BTTT-25	ASLK	150mA	2.5V	Tape and Reel	TSOT23 5-pin
AS1358-BTTT-26	ASLL	150mA	2.6V	Tape and Reel	TSOT23 5-pin
AS1358-BTTT-27	ASLM	150mA	2.7V	Tape and Reel	TSOT23 5-pin
AS1358-BTTT-28	ASLN	150mA	2.8V	Tape and Reel	TSOT23 5-pin
AS1358-BTTT-285	ASLO	150mA	2.85V	Tape and Reel	TSOT23 5-pin
AS1358-BTTT-30	ASLP	150mA	3.0V	Tape and Reel	TSOT23 5-pin
AS1358-BTTT-33	ASLQ	150mA	3.3V	Tape and Reel	TSOT23 5-pin
AS1358-BTTT-45	ASLR	150mA	4.5V	Tape and Reel	TSOT23 5-pin
AS1359-BTTT-15	ASLS	300mA	1.5V	Tape and Reel	TSOT23 5-pin
AS1359-BTTT-18	ASLT	300mA	1.8V	Tape and Reel	TSOT23 5-pin
AS1359-BTTT-25	ASLU	300mA	2.5V	Tape and Reel	TSOT23 5-pin
AS1359-BTTT-26	ASLV	300mA	2.6V	Tape and Reel	TSOT23 5-pin
AS1359-BTTT-27	ASLW	300mA	2.7V	Tape and Reel	TSOT23 5-pin
AS1359-BTTT-28	ASLX	300mA	2.8V	Tape and Reel	TSOT23 5-pin
AS1359-BTTT-285	ASLY	300mA	2.85V	Tape and Reel	TSOT23 5-pin
AS1359-BTTT-30	ASLZ	300mA	3.0V	Tape and Reel	TSOT23 5-pin
AS1359-BTTT-31	ASSA	300mA	3.1V	Tape and Reel	TSOT23 5-pin
AS1359-BTTT-33	ASL0	300mA	3.3V	Tape and Reel	TSOT23 5-pin
AS1359-BTTT-45	ASL1	300mA	4.5V	Tape and Reel	TSOT23 5-pin

Non-standard devices from 1.5V to 4.5V are available in 50mV steps. For more information and inquiries contact <http://www.austriamicrosystems.com/contact>

Note: All products are RoHS compliant and Pb-free.

Buy our products or get free samples online at ICdirect: <http://www.austriamicrosystems.com/ICdirect>

For further information and requests, please contact us <mailto:sales@austriamicrosystems.com> or find your local distributor at <http://www.austriamicrosystems.com/distributor>

Copyrights

Copyright © 1997-2009, austriamicrosystems AG, Tobelbaderstrasse 30, 8141 Unterpremstaetten, Austria-Europe. Trademarks Registered ®. All rights reserved. The material herein may not be reproduced, adapted, merged, translated, stored, or used without the prior written consent of the copyright owner.

All products and companies mentioned are trademarks or registered trademarks of their respective companies.

Disclaimer

Devices sold by austriamicrosystems AG are covered by the warranty and patent indemnification provisions appearing in its Term of Sale. austriamicrosystems AG makes no warranty, express, statutory, implied, or by description regarding the information set forth herein or regarding the freedom of the described devices from patent infringement. austriamicrosystems AG reserves the right to change specifications and prices at any time and without notice. Therefore, prior to designing this product into a system, it is necessary to check with austriamicrosystems AG for current information. This product is intended for use in normal commercial applications. Applications requiring extended temperature range, unusual environmental requirements, or high reliability applications, such as military, medical life-support or life-sustaining equipment are specifically not recommended without additional processing by austriamicrosystems AG for each application. For shipments of less than 100 parts the manufacturing flow might show deviations from the standard production flow, such as test flow or test location.

The information furnished here by austriamicrosystems AG is believed to be correct and accurate. However, austriamicrosystems AG shall not be liable to recipient or any third party for any damages, including but not limited to personal injury, property damage, loss of profits, loss of use, interruption of business or indirect, special, incidental or consequential damages, of any kind, in connection with or arising out of the furnishing, performance or use of the technical data herein. No obligation or liability to recipient or any third party shall arise or flow out of austriamicrosystems AG rendering of technical or other services.



Contact Information

Headquarters

austriamicrosystems AG
Tobelbaderstrasse 30
A-8141 Unterpremstaetten, Austria

Tel: +43 (0) 3136 500 0
Fax: +43 (0) 3136 525 01

For Sales Offices, Distributors and Representatives, please visit:

<http://www.austriamicrosystems.com/contact>

Looking for pricing, stock, or lifecycle information?

Click below to explore more details on WIN SOURCE:

 [View AS1358-BTTT-28](#) on WIN SOURCE

 [ams](#) Information

Optimize Your Supply Chain with WIN SOURCE Solutions

-  Global Sourcing Solution
-  Obsolete Management
-  Cost Control Management
-  Shortage Management
-  Alternative Solution
-  Excess Inventory Management