



**THE DATASHEET OF**  
**61083-082602LF**



61083- AA B C D E G W V FF

AA	NO. OF POSITIONS
02	2X10
04	2X20
06	2X30
08	2X40
10	2X50
12	2X60
14	2X70
16	2X80
18	2X90
20	2X100

NOTE 10

G	DATE CODE
/	STANDARD, NOT PRINT D/C
P	PRINT DATE CODE

W	TRANSPORT CODE
/	NOT MANDATORY
W	FOR OCEAN SHIPPING

E	PACKAGING
0	TUBE WITHOUT METAL CAP
2	T&R WITH METAL CAP
9	TUBE WITH METAL CAP
6	T&R WITH KAPTON TAPE
7	T&R WITH PLASTIC CAP
Q	T&R WITHOUTL CAP

NOTE 10  
NOTE 10  
NOTE 11  
NOTE 10

D	PEG
0	YES
2	NO

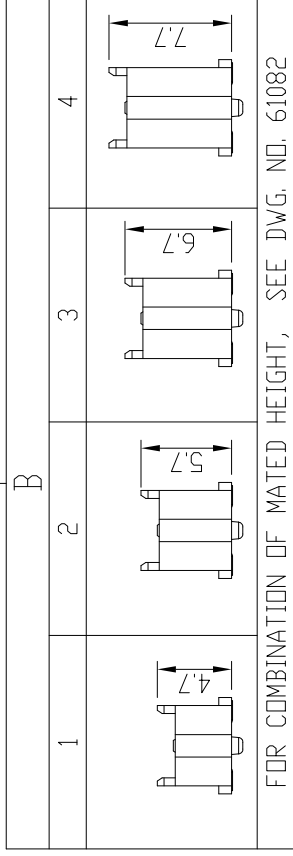

C	
0	GOLD 0.2 $\mu$ m MIN. ON CONTACT AREA; NICKEL UNDERPLATE OVERALL 1.27
1	GOLD FLASH (0.065 $\mu$ m MIN) OVER PLATE AREA; TIN LEAD 2.5 $\mu$ m MIN ON CONTACT AREA; NICKEL UNDERPLATE OVERALL 1.27
4	GOLD 0.2 $\mu$ m MIN ON CONTACT AREA; NICKEL UNDERPLATE OVERALL 1.27
5	GOLD 0.38 $\mu$ m MIN ON CONTACT AREA; NICKEL UNDERPLATE OVERALL 1.27
6	GOLD FLASH (0.065 $\mu$ m MIN) OVER PLATE AREA; PURE TIN 2.5 $\mu$ m MIN ON CONTACT AREA; NICKEL UNDERPLATE OVERALL 1.27
7	GOLD 0.76 $\mu$ m MIN ON CONTACT AREA; NICKEL UNDERPLATE OVERALL 1.27
9	GOLD 0.2 $\mu$ m MIN ON CONTACT AREA; NICKEL UNDERPLATE OVERALL 1.27

NOTE:

- MATERIAL:  
HOUSING: G.F. LCP, NATURAL, UL94-V0  
TERMINAL: BRASS
- PLATING: AS SHOWN IN TABLE.
- SEE GS-12-547 FOR PRODUCT SPEC.
- PACKAGING OPTION 2: NOT ALL SIZES ARE AVAILABLE. CHECK WITH FACTORY.
- THIS PRODUCT MEETS THE EUROPEAN UNION DIRECTIVES AND OTHER COUNTRY REGULATIONS AS DESCRIBED IN GS-22-008.
- THE HOUSING WILL WITHSTAND EXPOSURE UP TO 260~ PEAK TEMPERATURE FOR 30 SECONDS IN A CONVECTION, INFRA-RED OR VAPOR PHASE REFLOW OVEN.
- PLATING OPTION "4" IS LEADFREE ALTERNATIVE FOR OPTION "0", AND OPTION "6" IS LEADFREE ALTERNATIVE FOR OPTION "1".  
HIGH PRECISION COPPLANARITY IS AVAILABLE FOR 2X80 TO 2X100 PDS, ALL HEIGHTS. PLS REFER TO PRINT 10069525.
- THE P/N 61083-\*\*\*\*\* OR 61083-\*\*\*\*\*LF NOT PRINT DATE CODE.  
THE P/N 61083-\*\*\*\*\*P OR 61083-\*\*\*\*\*PLF NEED PRINT DATE CODE.
- POSITION 2X10 TYPE ONLY APPLY TO PLUG 1 AND PLUG 3.  
PACKAGING WITH METAL CAP AND PLASTIC CAP DOES NOT APPLY TO 2X10 POSITION.
- KAPTON TAPE ONLY APPLY TO POSITION 2X10~2X20.

mat'l. code	surface	ISO 1302
ltr	ecn no	dr
AP	EX-N-33922	Bob
		date
		2019-07-05
		tolerances un
		angles
		linear
AJ	EX-N-25201	Bob
		2016-12-29
		0 $\pm$ 3"
AK	EX-N-26185	Bob
		2017-02-17
		dr
		GuoMin
AL	EX-N-26381	Bob
		2017-03-17
		engr
AM	EX-N-30296	Bob
		2018-05-28
		chr
		LQ
		Le
AN	EX-N-30741	Bob
		2018-11-22
		opppd
		Tim Y
sheet	revision	AL
		AM
		AN
		AP
index	sheet	1~6
		1~6
		1

form: A3--2016-02--24

3

2

1

D

C

B

A

4

3

2

1

4 PDS: Rev

PRODUCT NO.	NO. OF POSITION	DIMENSION		
		A	B	C
61083-021***	2X10	7.2	13.8	12.2
61083-041***	2X20	15.2	21.8	20.2
61083-061***	2X30	23.2	29.8	28.2
61083-081***	2X40	31.2	37.8	36.2
61083-101***	2X50	39.2	45.8	44.2
61083-121***	2X60	47.2	53.8	52.2
61083-141***	2X70	55.2	61.8	60.2
61083-161***	2X80	63.2	69.8	68.2
61083-181***	2X90	71.2	77.8	76.2
61083-201***	2X100	79.2	85.8	84.2

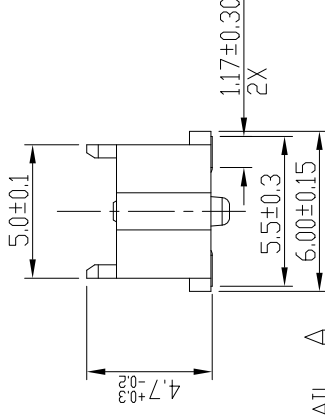
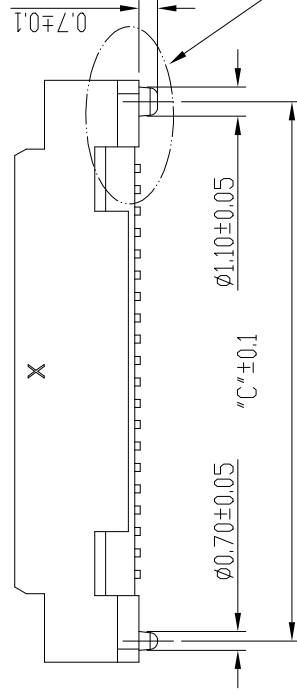
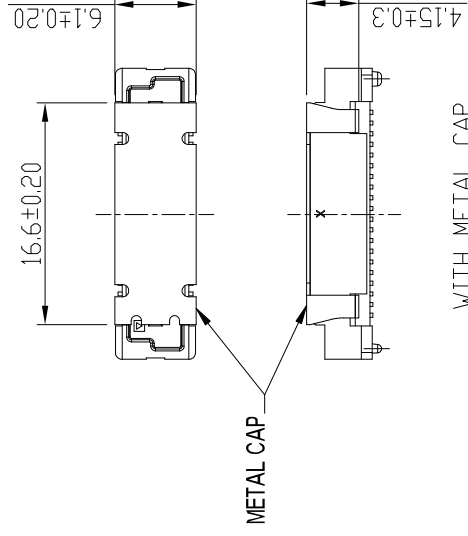
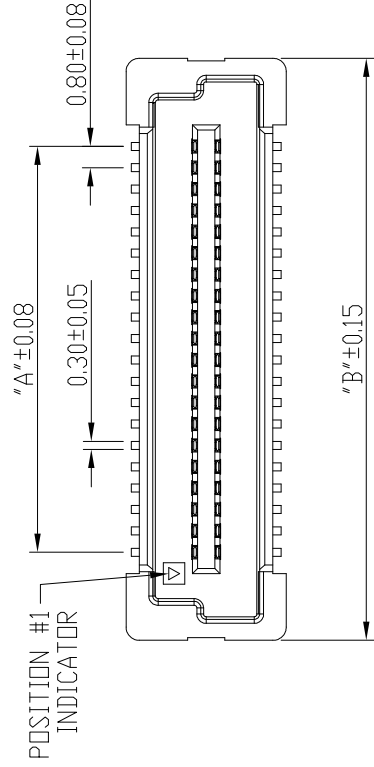

mat'l. code		surface	
ltr	ecn no dr	date	ISO 1302
AP			√
			tolerances un
			angles linear
			0° ± 3°
			dr
			GuoMin
			engr
			Bob C
			chr
			LQ Lc
			appd
			Tim Y
sheet	revision	AP	
index	sheet	1	

4 PDS: Rev

3

2

1

form: A3-2016-02-24

PRODUCT NO.	NO. OF POSITION	DIMENSION		
		A	B	C
61083-042***	2X20	15.2	21.8	20.2
61083-062***	2X30	23.2	29.8	28.2
61083-082***	2X40	31.2	37.8	36.2
61083-102***	2X50	39.2	45.8	44.2
61083-122***	2X60	47.2	53.8	52.2
61083-142***	2X70	55.2	61.8	60.2
61083-162***	2X80	63.2	69.8	68.2
61083-182***	2X90	71.2	77.8	76.2
61083-202***	2X100	79.2	85.8	84.2

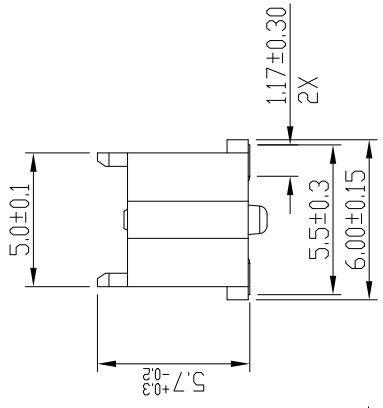
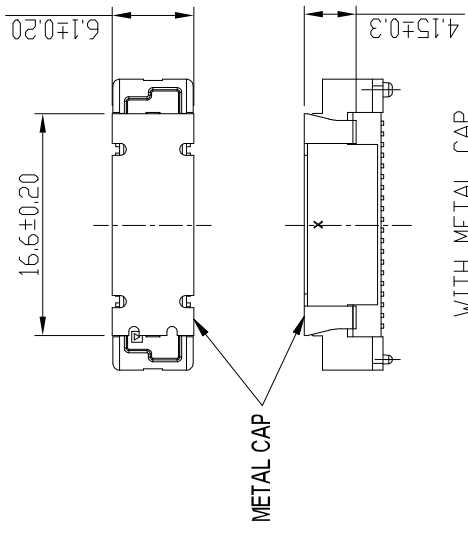
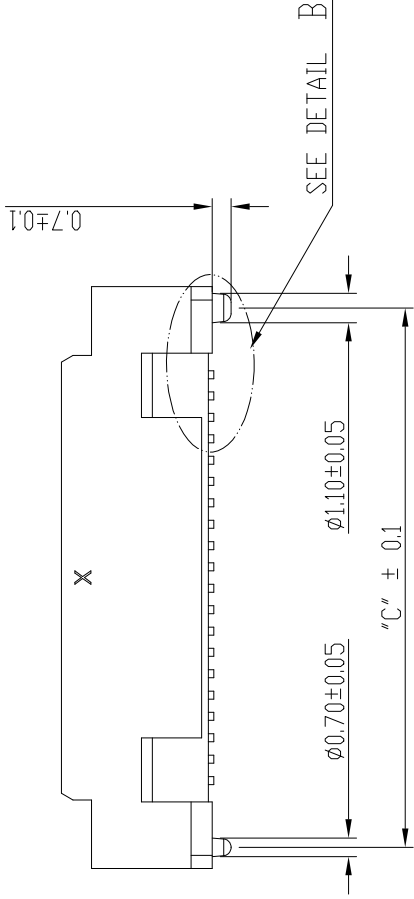
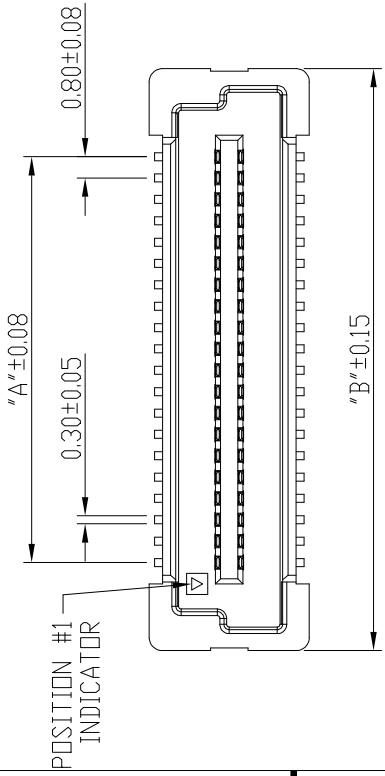

mat'l. code		surface	
ltr	ecn no dr	ISO 1302	✓
AP	date	tolerances un	
		angles	linear
		0° ± 3°	
		dr	GuoMin
		engr	Bob C
		chr	LQ Lc
		appd	Tim Y
sheet index	revision AP	sheet	1

form: A3-2016-02-24

1

2

3

4

PDS: Rev

PRODUCT NO.	NO. OF POSITION	DIMENSION		
		A	B	C
61083-023***	2X10	7.2	13.8	12.2
61083-043***	2X20	15.2	21.8	20.2
61083-063***	2X30	23.2	29.8	28.2
61083-083***	2X40	31.2	37.8	36.2
61083-103***	2X50	39.2	45.8	44.2
61083-123***	2X60	47.2	53.8	52.2
61083-143***	2X70	55.2	61.8	60.2
61083-163***	2X80	63.2	69.8	68.2
61083-183***	2X90	71.2	77.8	76.2
61083-203***	2X100	79.2	85.8	84.2

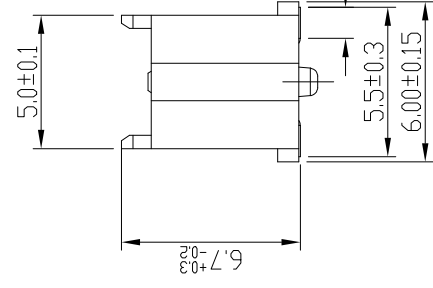
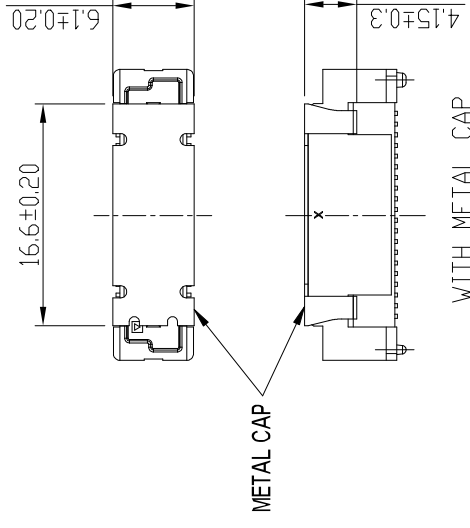
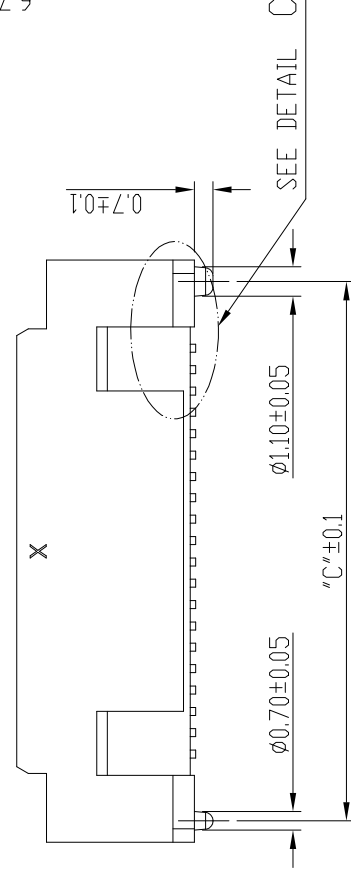
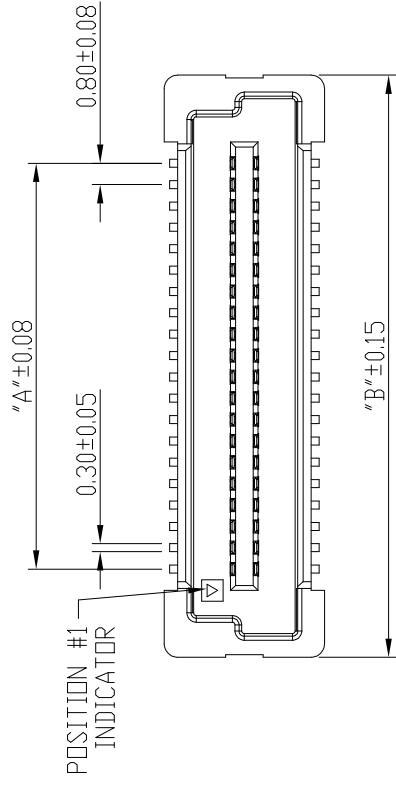

mat'l. code		surface	
ltr	ecn no dr	ISO 1302	tolerances un
AP			
		angles	linear
		0°±3°	
		dr	GuoMin
		engr	Bob C
		chr	LQ Lc
		appd	Tim Y
sheet index	revision AP	sheet	1

PRODUCT NO.	NO. OF POSITION	DIMENSION		
		A	B	C
61083-044***	2X20	15.2	21.8	20.2
61083-064***	2X30	23.2	29.8	28.2
61083-084***	2X40	31.2	37.8	36.2
61083-104***	2X50	39.2	45.8	44.2
61083-124***	2X60	47.2	53.8	52.2
61083-144***	2X70	55.2	61.8	60.2
61083-164***	2X80	63.2	69.8	68.2
61083-184***	2X90	71.2	77.8	76.2
61083-204***	2X100	79.2	85.8	84.2

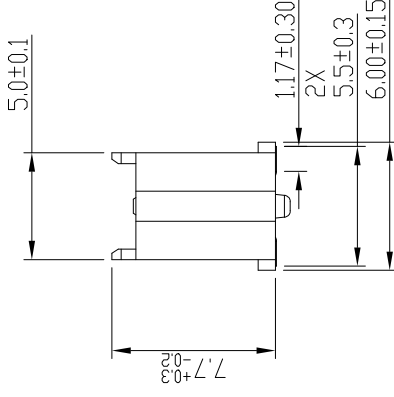
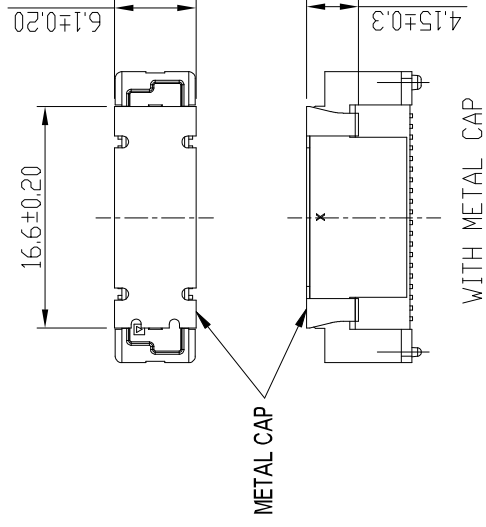
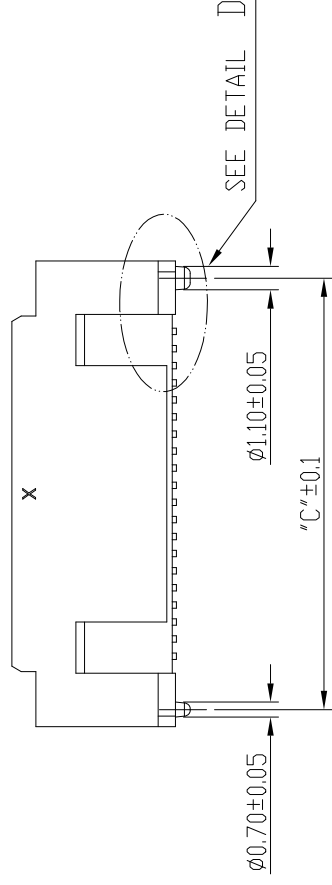
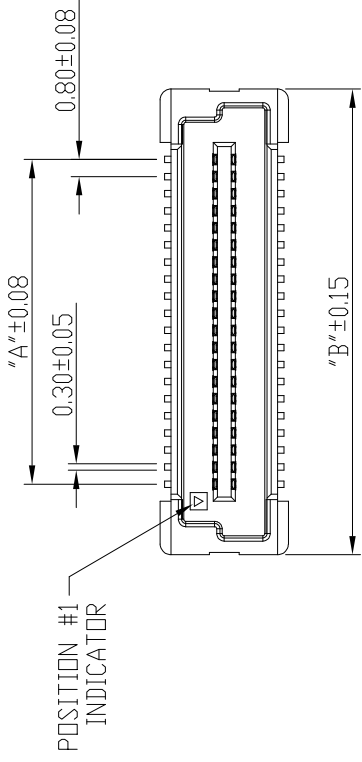

mat'l. code		surface	ISO 1302
ltr	ecn no dr	date	tolerances un
AP			angles linear
			0° ± 3°
			dr
			GuoMin
			engr
			Bob C
			chr
			LQ Le
			appd
			Tim Y
sheet index	revision AP	sheet	1

form: A3-2016-02-24

3

2

1

4

PDS: Rev

FOR PLUG 1/2/3/4

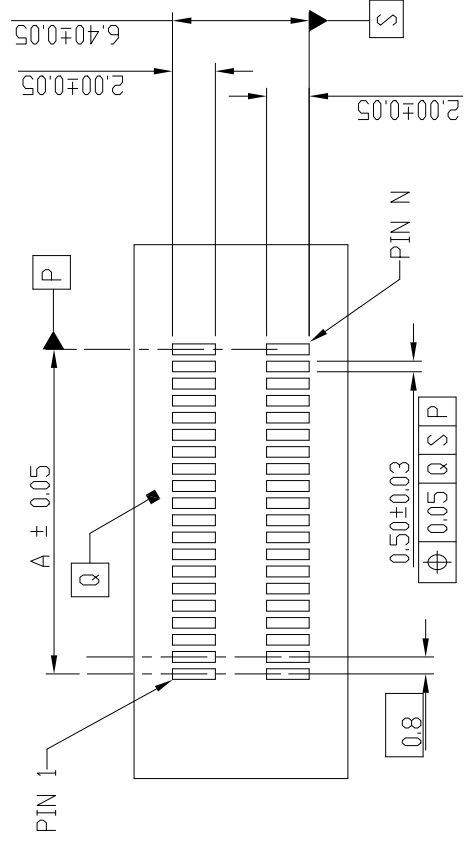

RECOMMENDED PCB LAYOUT WITHOUT PEG FOR  
 ND. OF POS 2X10, 2X20, 2X30, 2X40, 2X50 2X60

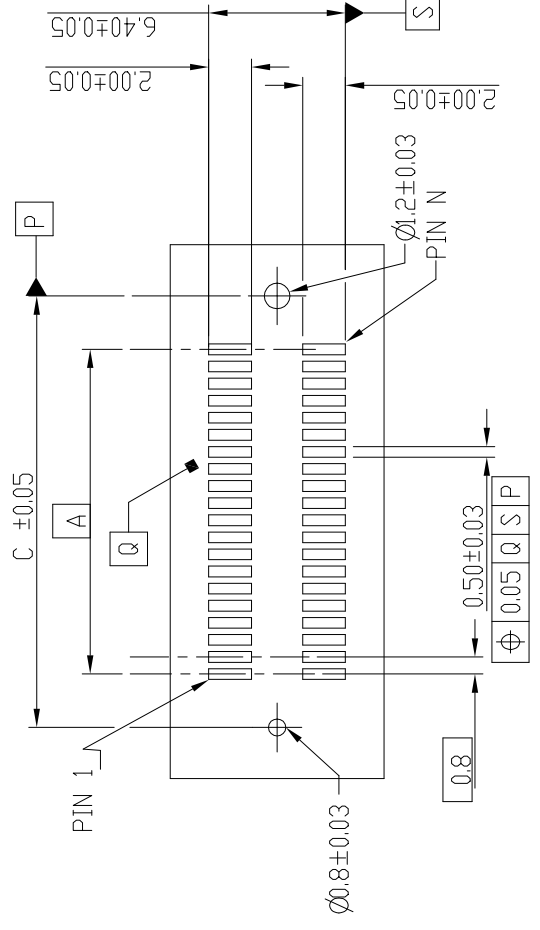

RECOMMENDED PCB LAYOUT WITH PEG FOR  
 ND. OF POS 2X10, 2X20, 2X30, 2X40, 2X50 2X60

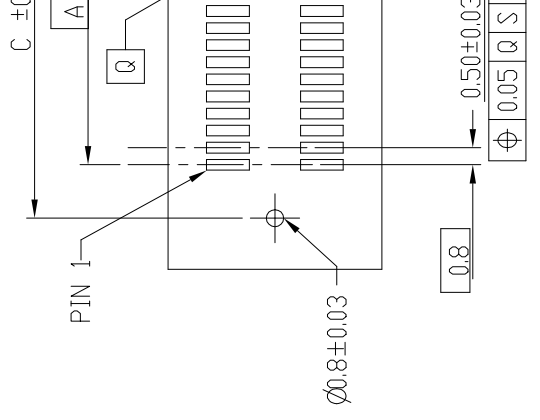



RECOMMENDED PCB LAYOUT  
 ND. OF POS 2X70, 2X80

mat'l. code		surface	ISO 1302	tolerances un
ltr	ecn no	dr	date	angles
AP				linear
		dr	0°±3°	
		GuoMin		
		engr		
		chr		
		LQ		
		appd		
		Tim Y.		
sheet	revision	AP		
index	sheet	1		

## Looking for pricing, stock, or lifecycle information?

Click below to explore more details on WIN SOURCE:

-  [View 61083-082602LF on WIN SOURCE](#)
-  [Amphenol FCI Information](#)

## Optimize Your Supply Chain with WIN SOURCE Solutions

-  Global Sourcing Solution
-  Obsolete Management
-  Cost Control Management
-  Shortage Management
-  Alternative Solution
-  Excess Inventory Management