

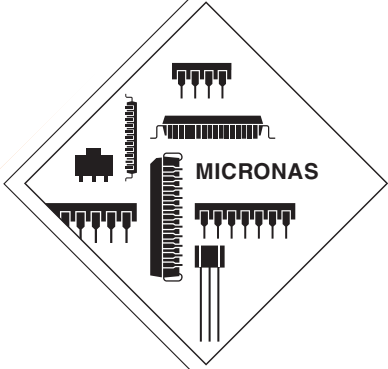

THE DATASHEET OF HAL815 UT-A





ADVANCE INFORMATION

HAL815 Programmable Linear Hall Sensor

Contents

Page	Section	Title
3	1.	Introduction
3	1.1.	Major Applications
3	1.2.	Features
4	1.3.	Marking Code
4	1.4.	Operating Junction Temperature Range (T_J)
4	1.5.	Hall Sensor Package Codes
4	1.6.	Solderability
4	1.7.	Pin Connections and Short Descriptions
5	2.	Functional Description
5	2.1.	General Function
7	2.2.	Digital Signal Processing and EEPROM
9	2.3.	Calibration Procedure
9	2.3.1.	General Procedure
10	2.3.2.	Calibration of the Angle Sensor
11	3.	Specifications
11	3.1.	Outline Dimensions
11	3.2.	Dimensions of Sensitive Area
11	3.3.	Position of Sensitive Area
12	3.4.	Absolute Maximum Ratings
12	3.5.	Recommended Operating Conditions
13	3.6.	Electrical Characteristics
14	3.7.	Magnetic Characteristics
14	3.8.	Open-Circuit Detection
14	3.9.	Overvoltage and Undervoltage Detection
15	3.10.	Typical Characteristics
17	4.	Application Notes
17	4.1.	Application Circuit
17	4.2.	Use of two HAL 815 in Parallel
17	4.3.	Temperature Compensation
18	4.4.	Undervoltage Behavior
18	4.5.	Ambient Temperature
18	4.6.	EMC and ESD
19	5.	Programming of the Sensor
19	5.1.	Definition of Programming Pulses
19	5.2.	Definition of the Telegram
21	5.3.	Telegram Codes
22	5.4.	Number Formats
23	5.5.	Register Information
23	5.6.	Programming Information
24	6.	Data Sheet History

Note: Some exclusivity restrictions may apply for the use of this sensor in automotive applications.

Programmable Linear Hall Effect Sensor

1. Introduction

The HAL 815 is a new member of the Micronas family of programmable linear Hall sensors. As an extension to the HAL 800, it offers open-circuit, as well as over-voltage and undervoltage detection and individual programming of different sensors which are in parallel to the same supply voltage.

The HAL 815 is an universal magnetic field sensor with a linear output based on the Hall effect. The IC is designed and produced in sub-micron CMOS technology and can be used for angle or distance measurements if combined with a rotating or moving magnet. The major characteristics like magnetic field range, sensitivity, output quiescent voltage (output voltage at $B = 0$ mT), and output voltage range are programmable in a non-volatile memory. The sensor has a ratio-metric output characteristic, which means that the output voltage is proportional to the magnetic flux and the supply voltage.

The HAL 815 features a temperature-compensated Hall plate with chopped offset compensation, an A/D converter, digital signal processing, a D/A converter with output driver, an EEPROM memory with redundancy and lock function for the calibration data, a serial interface for programming the EEPROM, and protection devices at all pins. The internal digital signal processing is of great benefit because analog offsets, temperature shifts, and mechanical stress do not degrade the sensor accuracy.

The HAL 815 is programmable by modulating the supply voltage. No additional programming pin is needed. The easy programmability allows a 2-point calibration by adjusting the output voltage directly to the input signal (like mechanical angle, distance, or current). Individual adjustment of each sensor during the customer's manufacturing process is possible. With this calibration procedure, the tolerances of the sensor, the magnet, and the mechanical positioning can be compensated in the final assembly. This offers a low-cost alternative for all applications that presently need mechanical adjustment or laser trimming for calibrating the system.

In addition, the temperature compensation of the Hall IC can be fit to all common magnetic materials by programming first and second order temperature coefficients of the Hall sensor sensitivity. This enables operation over the full temperature range with high accuracy.

The calculation of the individual sensor characteristics and the programming of the EEPROM memory can easily be done with a PC and the application kit from Micronas.

The sensor is designed for hostile industrial and automotive applications and operates with typically 5 V supply voltage in the ambient temperature range from -40 °C up to 150 °C. The HAL 815 is available in the very small leaded package TO-92UT.

1.1. Major Applications

Due to the sensor's versatile programming characteristics, the HAL 815 is the optimal system solution for applications such as:

- contactless potentiometers,
- angle sensors,
- distance measurements,
- magnetic field and current measurement.

1.2. Features

- high-precision linear Hall effect sensor with ratio-metric output and digital signal processing
- multiple programmable magnetic characteristics in a non-volatile memory (EEPROM) with redundancy and lock function
- open-circuit (ground and supply line break detection), overvoltage and undervoltage detection
- for programming an individual sensor within several sensors in parallel to the same supply voltage, a selection can be done via the output pin
- to enable programming of an individual sensor amongst several sensors running parallel to the same supply voltage, each sensor can be selected via its output pin
- temperature characteristics are programmable for matching all common magnetic materials
- programmable clamping function
- programming through a modulation of the supply voltage
- operates from -40 °C up to 150 °C ambient temperature
- operates from 4.5 V up to 5.5 V supply voltage in specification and functions up to 8.5 V
- total error $< 2.0\%$ over operating voltage range and temperature range
- operates with static magnetic fields and dynamic magnetic fields up to 2 kHz
- overvoltage and reverse-voltage protection at all pins
- magnetic characteristics extremely robust against mechanical stress
- short-circuit protected push-pull output
- EMC and ESD optimized design

1.3. Marking Code

The HAL 815 has a marking on the package surface (branded side). This marking includes the name of the sensor and the temperature range.

Type	Temperature Range		
	A	K	E
HAL 815	815A	815K	815E

1.4. Operating Junction Temperature Range (T_J)

The Hall sensors from Micronas are specified to the chip temperature (junction temperature T_J).

A: $T_J = -40\text{ °C to }+170\text{ °C}$

K: $T_J = -40\text{ °C to }+140\text{ °C}$

E: $T_J = -40\text{ °C to }+100\text{ °C}$

The relationship between ambient temperature (T_A) and junction temperature is explained in Section 4.5. on page 18.

1.5. Hall Sensor Package Codes

HALXXXPA-T

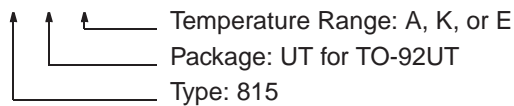

Example: **HAL815UT-K**

- Type: 815
- Package: TO-92UT
- Temperature Range: $T_J = -40\text{ °C to }+140\text{ °C}$

Hall sensors are available in a wide variety of packaging versions and quantities. For more detailed information, please refer to the brochure: “Ordering Codes for Hall Sensors”.

1.6. Solderability

Package TO-92UT: according to IEC68-2-58

During soldering reflow processing and manual reworking, a component body temperature of 260 °C should not be exceeded.

Components stored in the original packaging should provide a shelf life of at least 12 months, starting from the date code printed on the package labels, even in environments as extreme as 40 °C and 90% relative humidity.

1.7. Pin Connections and Short Descriptions

Pin No.	Pin Name	Type	Short Description
1	V_{DD}	IN	Supply Voltage and Programming Pin
2	GND		Ground
3	OUT	OUT	Push Pull Output and Selection Pin

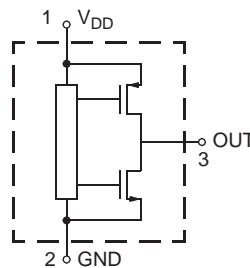

Fig. 1–1: Pin configuration

2. Functional Description

2.1. General Function

The HAL 815 is a monolithic integrated circuit which provides an output voltage proportional to the magnetic flux through the Hall plate and proportional to the supply voltage (ratiometric behavior).

The external magnetic field component perpendicular to the branded side of the package generates a Hall voltage. The Hall IC is sensitive to magnetic north and south polarity. This voltage is converted to a digital value, processed in the Digital Signal Processing Unit (DSP) according to the settings of the EEPROM registers, converted to an analog voltage with ratiometric behavior, and stabilized by a push-pull output transistor stage. The function and the parameters for the DSP are explained in Section 2.2. on page 7.

The setting of the LOCK register disables the programming of the EEPROM memory for all time. This register cannot be reset.

As long as the LOCK register is not set, the output characteristic can be adjusted by programming the EEPROM registers. The IC is addressed by modulating the supply voltage (see Fig. 2-1). In the supply voltage range from 4.5 V up to 5.5 V, the sensor generates an analog output voltage. After detecting a command, the sensor reads or writes the memory and answers with a digital signal on the output pin. The

analog output is switched off during the communication.

Several sensors in parallel to the same supply and ground line can be programmed individually. The selection of each sensor is done via its output pin.

The open-circuit detection provides a defined output voltage if the V_{DD} or GND line is broken. Internal temperature compensation circuitry and the chopped off-set compensation enables operation over the full temperature range with minimal changes in accuracy and high offset stability. The circuitry also rejects offset shifts due to mechanical stress from the package. The non-volatile memory consists of redundant EEPROM cells. In addition, the sensor IC is equipped with devices for overvoltage and reverse-voltage protection at all pins.

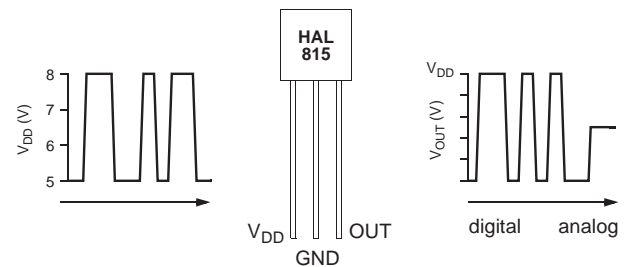

Fig. 2-1: Programming with V_{DD} modulation

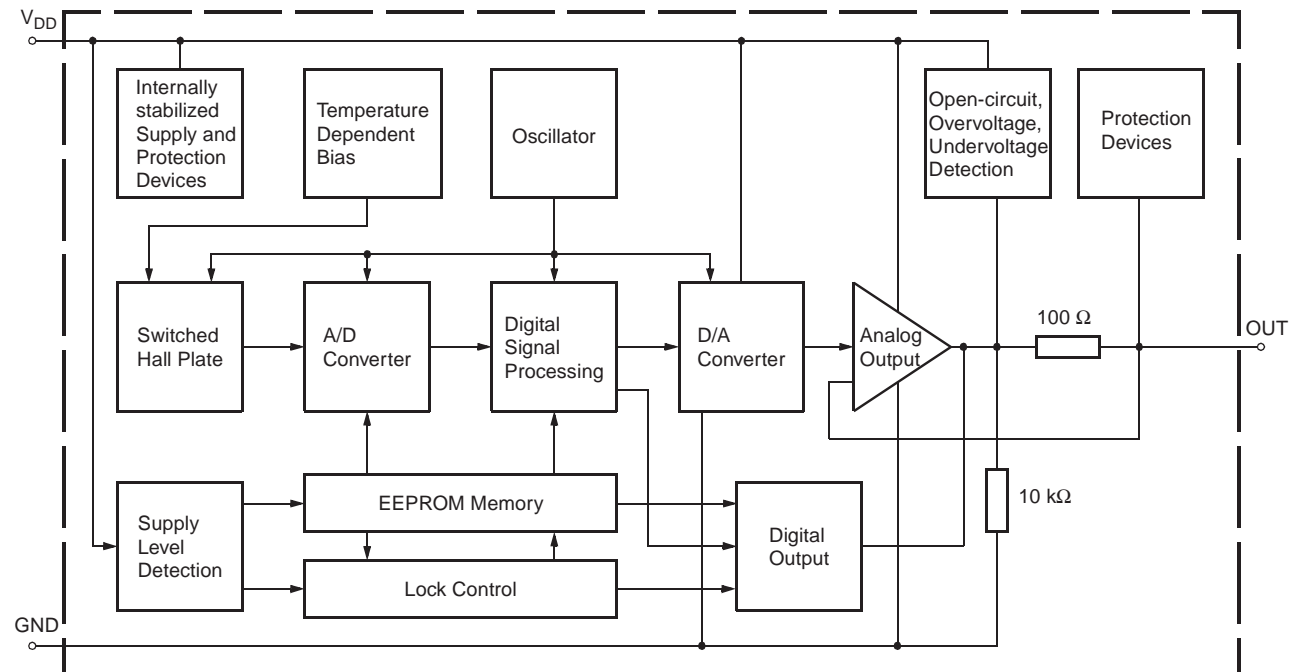

Fig. 2-2: HAL 815 block diagram

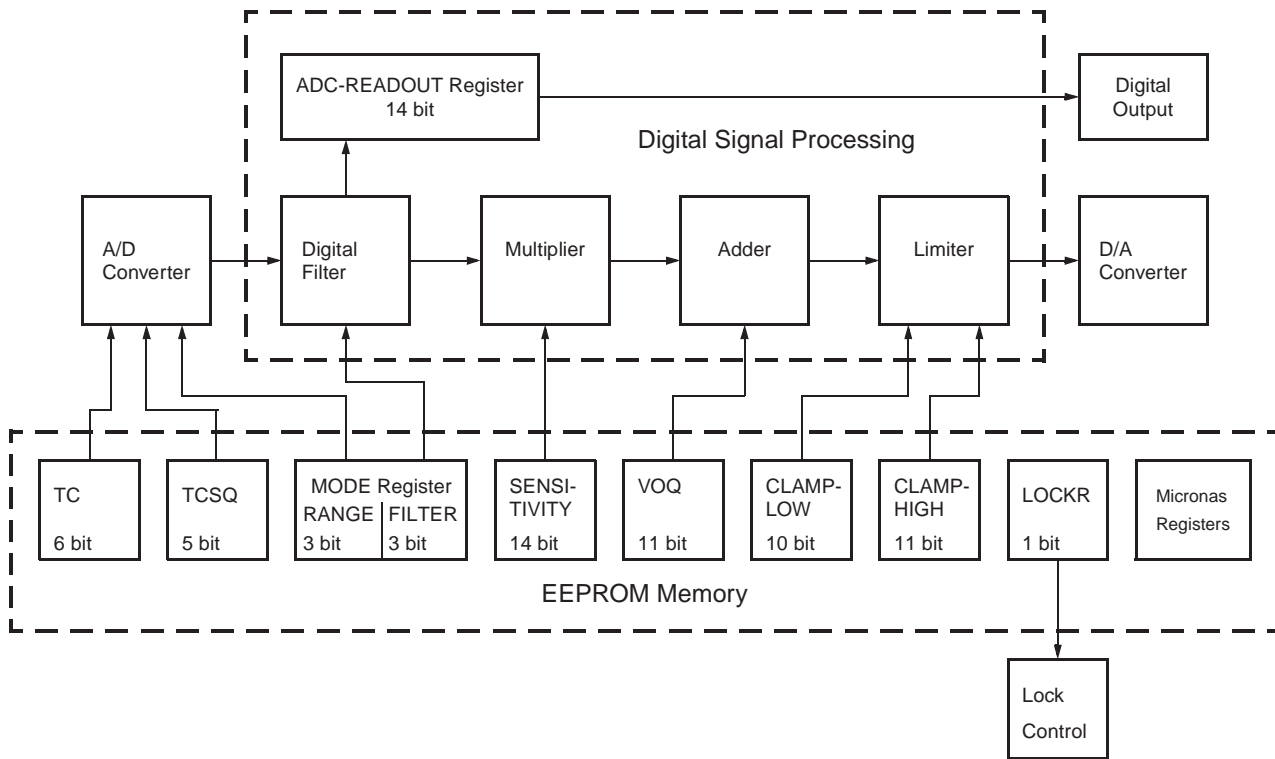
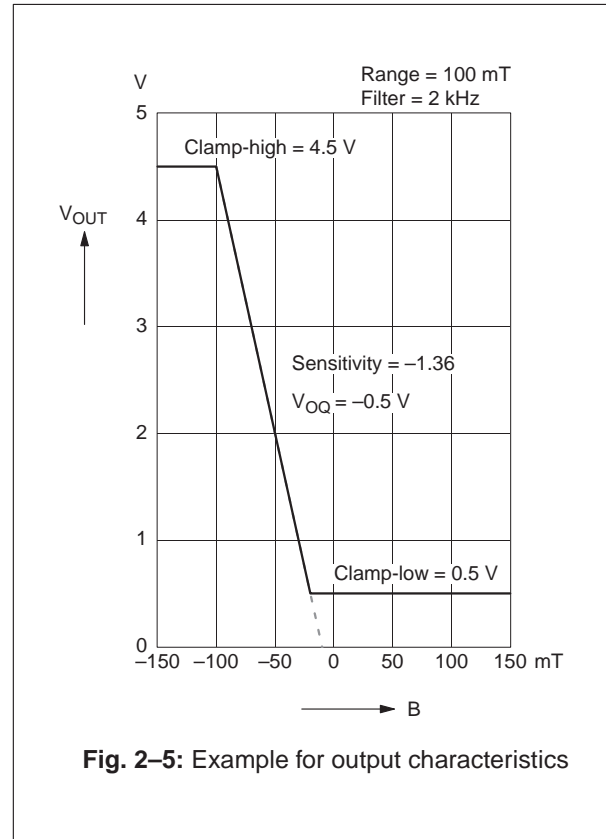
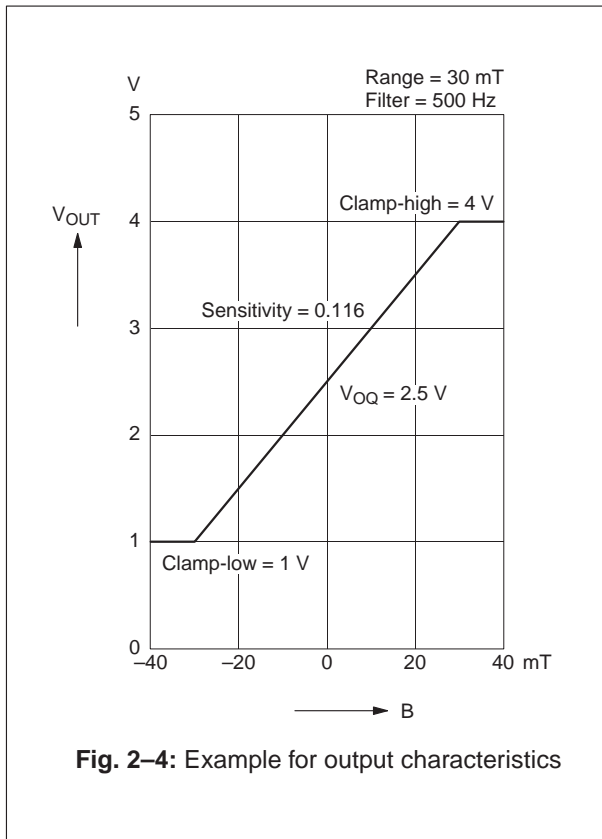

Fig. 2-3: Details of EEPROM and Digital Signal Processing



2.2. Digital Signal Processing and EEPROM

The DSP is the main part of this sensor and performs the signal conditioning. The parameters for the DSP are stored in the EEPROM registers. The details are shown in Fig. 2–3.

Terminology:

SENSITIVITY: name of the register or register value

Sensitivity: name of the parameter

The EEPROM registers consist of three groups:

Group 1 contains the registers for the adaption of the sensor to the magnetic system: MODE for selecting the magnetic field range and filter frequency, TC and TCSQ for the temperature characteristics of the magnetic sensitivity.

Group 2 contains the registers for defining the output characteristics: SENSITIVITY, VOQ, CLAMP-LOW, and CLAMP-HIGH. The output characteristic of the sensor is defined by these 4 parameters (see Fig. 2–4 and Fig. 2–5 for examples).

- The parameter V_{OQ} (Output Quiescent Voltage) corresponds to the output voltage at $B = 0$ mT.
- The parameter Sensitivity defines the magnetic sensitivity:

$$Sensitivity = \frac{\Delta V_{OUT}}{\Delta B}$$

- The output voltage can be calculated as:

$$V_{OUT} \sim Sensitivity \times B + V_{OQ}$$

The output voltage range can be clamped by setting the registers CLAMP-LOW and CLAMP-HIGH in order to enable failure detection (such as short-circuits to V_{DD} or GND and open connections).

Group 3 contains the Micronas registers and LOCK for the locking of all registers. The Micronas registers are programmed and locked during production and are read-only for the customer. These registers are used for oscillator frequency trimming, A/D converter offset compensation, and several other special settings.

An external magnetic field generates a Hall voltage on the Hall plate. The ADC converts the amplified positive or negative Hall voltage (operates with magnetic north and south poles at the branded side of the package) to a digital value. Positive values correspond to a magnetic north pole on the branded side of the package. The digital signal is filtered in the internal low-pass filter and is readable in the ADC-READOUT register. Depending on the programmable magnetic range of the Hall IC, the operating range of the A/D converter is from –30 mT...+30 mT up to –150 mT...+150 mT.

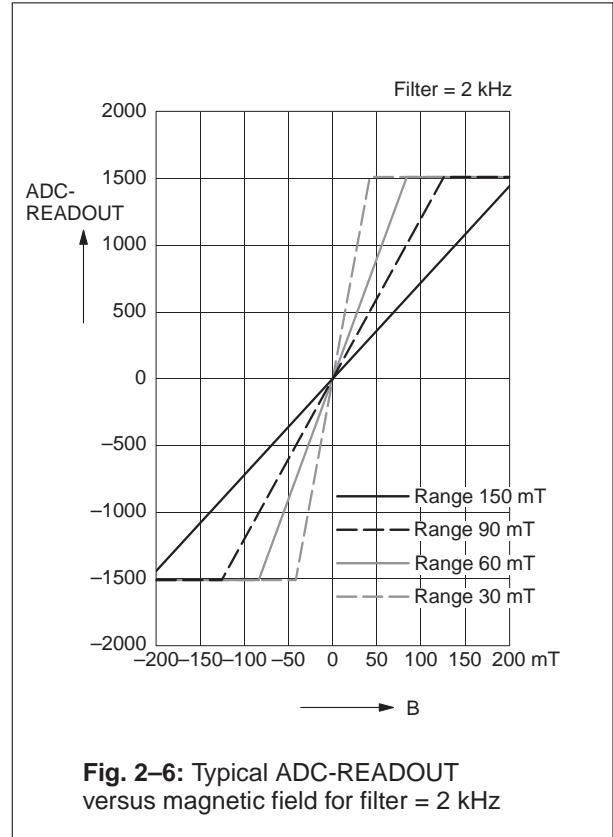

Fig. 2–6: Typical ADC-READOUT versus magnetic field for filter = 2 kHz

During further processing, the digital signal is multiplied with the sensitivity factor, added to the quiescent output voltage and limited according to the clamping voltage. The result is converted to an analog signal and stabilized by a push-pull output transistor stage.

The ADC-READOUT at any given magnetic field depends on the programmed magnetic field range but also on the filter frequency. Fig. 2–6 shows the typical ADC-READOUT values for the different magnetic field ranges with the filter frequency set to 2 kHz. The relationship between the minimum and maximum ADC-READOUT values and the filter frequency setting is listed in the following table.

Filter Frequency	ADC-READOUT RANGE
80 Hz	–3968...3967
160 Hz	–1985...1985
500 Hz	–5292...5290
1 kHz	–2646...2645
2 kHz	–1512...1511

Note: During application design, it should be taken into consideration that the maximum and minimum ADC-READOUT is not exceeded during calibration and operation of the Hall IC. Consequently, the maximum and minimum magnetic fields that may occur in the operational range of a specific application should not saturate the A/D converter. Please note that the A/D converter saturates at magnetic fields well above, respectively below, the magnetic range limits. This large safety band between specified magnetic range and true operational range helps to avoid any saturation.

Range

The RANGE bits are the three lowest bits of the MODE register; they define the magnetic field range of the A/D converter.

Magnetic Field Range	RANGE
-30 mT...30 mT	0
-40 mT...40 mT	4
-60 mT...60 mT	5
-75 mT...75 mT	1
-80 mT...80 mT	6
-90 mT...90 mT	2
-100 mT...100 mT	7
-150 mT...150 mT	3

Filter

The FILTER bits are the three highest bits of the MODE register; they define the -3 dB frequency of the digital low pass filter.

-3 dB Frequency	FILTER
80 Hz	0
160 Hz	1
500 Hz	2
1 kHz	3
2 kHz	4

TC and TCSQ

The temperature dependence of the magnetic sensitivity can be adapted to different magnetic materials in order to compensate for the change of the magnetic strength with temperature. The adaption is done by programming the TC (Temperature Coefficient) and the TCSQ registers (Quadratic Temperature Coefficient). Thereby, the slope and the curvature of the temperature dependence of the magnetic sensitivity can be matched to the magnet and the sensor assembly. As a result, the output voltage characteristic can be fixed over the full temperature range. The sensor can compensate for linear temperature coefficients ranging from about -3100 ppm/K up to 400 ppm/K and quadratic coefficients from about -5 ppm/K² to 5 ppm/K². Please refer to Section 4.3. on page 17 for the recommended settings for different linear temperature coefficients.

Sensitivity

The SENSITIVITY register contains the parameter for the multiplier in the DSP. The Sensitivity is programmable between -4 and 4. For V_{DD} = 5 V, the register can be changed in steps of 0.00049. Sensitivity = 1 corresponds to an increase of the output voltage by V_{DD} if the ADC-READOUT increases by 2048.

For all calculations, the digital value from the magnetic field of the A/D converter is used. This digital information is readable from the ADC-READOUT register.

$$Sensitivity = \frac{\Delta V_{OUT} * 2048}{\Delta ADC-READOUT * V_{DD}}$$

VOQ

The VOQ register contains the parameter for the adder in the DSP. V_{OQ} is the output voltage without external magnetic field (B = 0 mT, respectively ADC-READOUT = 0) and programmable from -V_{DD} up to V_{DD}. For V_{DD} = 5 V, the register can be changed in steps of 4.9 mV.

Note: If V_{OQ} is programmed to a negative voltage, the maximum output voltage is limited to:

$$V_{OUTmax} = V_{OQ} + V_{DD}$$

For calibration in the system environment, a 2-point adjustment procedure (see Section 2.3.) is recommended. The suitable Sensitivity and V_{OQ} values for each sensor can be calculated individually by this procedure.

Clamping Voltage

The output voltage range can be clamped in order to detect failures like shorts to V_{DD} or GND or an open circuit.

The CLAMP-LOW register contains the parameter for the lower limit. The lower clamping voltage is programmable between 0 V and $V_{DD}/2$. For $V_{DD} = 5$ V, the register can be changed in steps of 2.44 mV.

The CLAMP-HIGH register contains the parameter for the upper limit. The upper clamping voltage is programmable between 0 V and V_{DD} . For $V_{DD} = 5$ V, in steps of 2.44 mV.

LOCKR

By setting this 1-bit register, all registers will be locked, and the sensor will no longer respond to any supply voltage modulation.

Warning: This register cannot be reset!

ADC-READOUT

This 14-bit register delivers the actual digital value of the applied magnetic field before the signal processing. This register can be read out and is the basis for the calibration procedure of the sensor in the system environment.

2.3. Calibration Procedure

2.3.1. General Procedure

For calibration in the system environment, the application kit from Micronas is recommended. It contains the hardware for the generation of the serial telegram for programming and the corresponding software for the input of the register values.

In this section, programming of the sensor using this programming tool is explained. Please refer to Section 5. on page 19 for information about programming without this tool.

For the individual calibration of each sensor in the customer application, a two point adjustment is recommended (see Fig. 2–7 for an example). When using the application kit, the calibration can be done in three steps:

Step 1: Input of the registers which need not be adjusted individually

The magnetic circuit, the magnetic material with its temperature characteristics, the filter frequency, and low and high clamping voltage are given for this application.

Therefore, the values of the following registers should be identical for all sensors of the customer application.

- FILTER
(according to the maximum signal frequency)
- RANGE
(according to the maximum magnetic field at the sensor position)
- TC and TCSQ
(depends on the material of the magnet and the other temperature dependencies of the application)
- CLAMP-LOW and CLAMP-HIGH
(according to the application requirements)

Write the appropriate settings into the HAL 815 registers.

Step 2: Calculation of V_{OQ} and Sensitivity

The calibration points 1 and 2 can be set inside the specified range. The corresponding values for V_{OUT1} and V_{OUT2} result from the application requirements.

$$Low\ clamping\ voltage \leq V_{OUT1,2} \leq High\ clamping\ voltage$$

For highest accuracy of the sensor, calibration points near the minimum and maximum input signal are recommended. The difference of the output voltage between calibration point 1 and calibration point 2 should be more than 3.5 V.

Set the system to calibration point 1 and read the register ADC-READOUT. The result is the value ADC-READOUT1.

Now, set the system to calibration point 2, read the register ADC-READOUT again, and get the value ADC-READOUT2.

With these values and the target values V_{OUT1} and V_{OUT2} , for the calibration points 1 and 2, respectively, the values for Sensitivity and V_{OQ} are calculated as:

$$Sensitivity = \frac{V_{OUT1} - V_{OUT2}}{ADC-READOUT1 - ADC-READOUT2} * \frac{2048}{V_{DD}}$$

$$V_{OQ} = V_{OUT1} - \frac{ADC-READOUT1 * Sensitivity * V_{DD}}{2048}$$

This calculation has to be done individually for each sensor.

Next, write the calculated values for Sensitivity and V_{OQ} into the IC for adjusting the sensor.

The sensor is now calibrated for the customer application. However, the programming can be changed again and again if necessary.

Step 3: Locking the Sensor

The last step is activating the LOCK function with the "LOCK" command. The sensor is now locked and does not respond to any programming or reading commands.

Warning: This register cannot be reset!

2.3.2. Calibration of the Angle Sensor

The following description explains the calibration procedure using an angle sensor as an example. The required output characteristic is shown in Fig. 2–7.

- the angle range is from -25° to 25°
- temperature coefficient of the magnet: -500 ppm/K

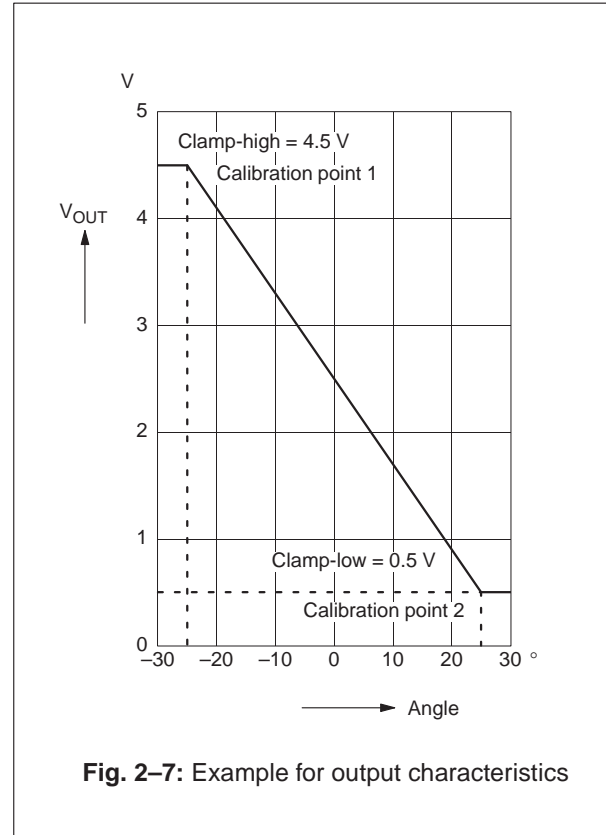

Fig. 2–7: Example for output characteristics

Step 1: Input of the registers which need not be adjusted individually

The register values for the following registers are given for all applications:

- FILTER
Select the filter frequency: 500 Hz
- RANGE
Select the magnetic field range: 30 mT
- TC
For this magnetic material: 6
- TCSQ
For this magnetic material: 14
- CLAMP-LOW
For our example: 0.5 V
- CLAMP-HIGH
For our example: 4.5 V

Enter these values in the software, and use the "write and store" command for permanently writing the values in the registers.

Step 2: Calculation of V_{OQ} and Sensitivity

There are two ways to calculate the values for V_{OQ} and Sensitivity.

Manual Calculation:

Set the system to calibration point 1 (angle 1 = -25°) and read the register ADC-READOUT. For our example, the result is $ADC-READOUT1 = -2500$.

Next, set the system to calibration point 2 (angle 2 = 25°), and read the register ADC-READOUT again. For our example, the result is $ADC-READOUT2 = +2350$.

With these measurements and the targets $V_{OUT1} = 4.5\text{ V}$ and $V_{OUT2} = 0.5\text{ V}$, the values for Sensitivity and V_{OQ} are calculated as

$$Sensitivity = \frac{4.5\text{ V} - 0.5\text{ V}}{-2500 - 2350} * \frac{2048}{5\text{ V}} = -0.3378$$

$$V_{OQ} = 4.5\text{ V} - \frac{-2500 * (-0.3378) * 5\text{ V}}{2048} = 2.438\text{ V}$$

Software Calibration:

Use the menu CALIBRATE from the PC software and enter the values 4.5 V for V_{OUT1} and 0.5 V for V_{OUT2} . Set the system to calibration point 1 (angle 1 = -25°), hit the button “Read ADC-Readout1”, set the system to calibration point 2 (angle 2 = 25°), hit the button “Read ADC-Readout2”, and hit the button “Calculate”. The software will then calculate the appropriate V_{OQ} and Sensitivity.

This calculation has to be done individually for each sensor. Now, write the calculated values with the “write and store” command into the HAL 815 for programming the sensor.

Step 3: Locking the Sensor

The last step is activating the LOCK function with the “LOCK” command. The sensor is now locked and does not respond to any programming or reading commands.

Warning: This register cannot be reset!

3. Specifications

3.1. Outline Dimensions

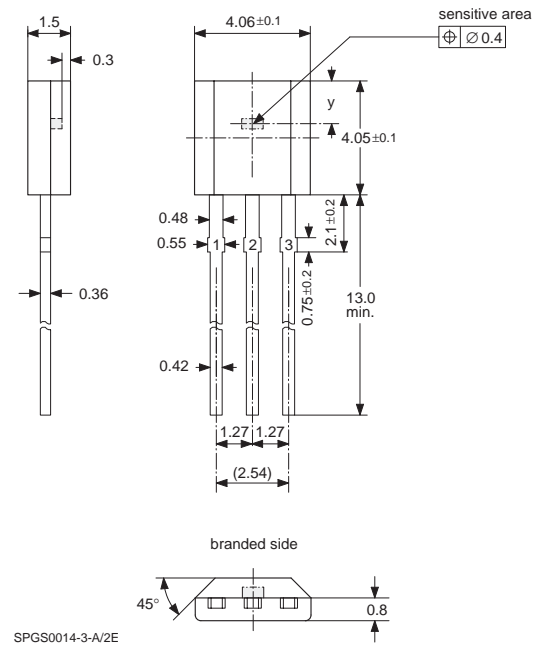

Fig. 3-1:
 Plastic Transistor Single Outline Package
(TO-92UT)
 Weight approximately 0.14 g
 Dimensions in mm

Note: A mechanical tolerance of $\pm 50\ \mu\text{m}$ applies to all dimensions where no tolerance is explicitly given.

3.2. Dimensions of Sensitive Area

0.25 mm x 0.25 mm

3.3. Position of Sensitive Area

TO-92UT
center of the package
y = 1.5 mm nominal

3.4. Absolute Maximum Ratings

Symbol	Parameter	Pin No.	Min.	Max.	Unit
V_{DD}	Supply Voltage	1	-8.5	8.5	V
V_{DD}	Supply Voltage	1	-14.4 ^{1) 2)}	14.4 ^{1) 2)}	V
$-I_{DD}$	Reverse Supply Current	1	-	50 ¹⁾	mA
I_Z	Current through Protection Device	1 or 3	-300 ⁴⁾	300 ⁴⁾	mA
V_{OUT}	Output Voltage	3	-5 ⁶⁾ -5 ⁶⁾	8.5 ³⁾ 14.4 ^{3) 2)}	V
$V_{OUT} - V_{DD}$	Excess of Output Voltage over Supply Voltage	3,1		2	V
I_{OUT}	Continuous Output Current	3	-10	10	mA
t_{Sh}	Output Short Circuit Duration	3	-	10	min
T_S	Storage Temperature Range		-65	150	°C
T_J	Junction Temperature Range		-40 -40	170 ⁵⁾ 150	°C °C

¹⁾ as long as T_{Jmax} is not exceeded
²⁾ $t < 10$ min ($V_{DDmin} = -15$ V for $t < 1$ min, $V_{DDmax} = 16$ V for $t < 1$ min)
³⁾ as long as T_{Jmax} is not exceeded, output is not protected to external 14 V-line (or to -14 V)
⁴⁾ $t < 2$ ms
⁵⁾ $t < 1000$ h
⁶⁾ internal protection resistor = 100 Ω

Stresses beyond those listed in the “Absolute Maximum Ratings” may cause permanent damage to the device. This is a stress rating only. Functional operation of the device at these or any other conditions beyond those indicated in the “Recommended Operating Conditions/Characteristics” of this specification is not implied. Exposure to absolute maximum ratings conditions for extended periods may affect device reliability.

3.5. Recommended Operating Conditions

Symbol	Parameter	Pin No.	Min.	Typ.	Max.	Unit
V_{DD}	Supply Voltage	1	4.5	5	5.5	V
I_{OUT}	Continuous Output Current	3	-1	-	1	mA
R_L	Load Resistor	3	4.5	-	-	k Ω
C_L	Load Capacitance	3	0.33	10	1000	nF

3.6. Electrical Characteristics

at $T_J = -40\text{ }^\circ\text{C}$ to $+170\text{ }^\circ\text{C}$, $V_{DD} = 4.5\text{ V}$ to 5.5 V , after programming, as not otherwise specified in Conditions.
Typical Characteristics for $T_J = 25\text{ }^\circ\text{C}$ and $V_{DD} = 5\text{ V}$.

Symbol	Parameter	Pin No.	Min.	Typ.	Max.	Unit	Conditions
I_{DD}	Supply Current over Temperature Range	1		7	10	mA	
V_{DDZ}	Overvoltage Protection at Supply	1		17.5	20	V	$I_{DD} = 25\text{ mA}$, $T_J = 25\text{ }^\circ\text{C}$, $t = 20\text{ ms}$
V_{OZ}	Overvoltage Protection at Output	3		17	19.5	V	$I_O = 10\text{ mA}$, $T_J = 25\text{ }^\circ\text{C}$, $t = 20\text{ ms}$
	Resolution	3		12		bit	ratiometric to V_{DD} ¹⁾
E_A	Accuracy Error over all	3	-2	0	2	%	$R_L = 4.7\text{ k}\Omega$ (% of supply voltage) ³⁾
INL	Non-Linearity of Output Voltage over Temperature	3	-1	0	1	%	% of supply voltage ³⁾
E_R	Ratiometric Error of Output over Temperature (Error in V_{OUT} / V_{DD})	3	-1	0	1	%	$ V_{OUT1} - V_{OUT2} > 2\text{ V}$ during calibration procedure
ΔV_{OUTCL}	Accuracy of Output Voltage at Clamping Low Voltage over Temperature Range	3	-45	0	45	mV	$R_L = 4.7\text{ k}\Omega$, $V_{DD} = 5\text{ V}$
ΔV_{OUTCH}	Accuracy of Output Voltage at Clamping High Voltage over Temperature Range	3	-45	0	45	mV	$R_L = 4.7\text{ k}\Omega$, $V_{DD} = 5\text{ V}$
V_{OUTH}	Output High Voltage	3	4.65	4.8		V	$V_{DD} = 5\text{ V}$, $-1\text{ mA} \leq I_{OUT} \leq 1\text{ mA}$
V_{OUTL}	Output Low Voltage	3		0.2	0.35	V	$V_{DD} = 5\text{ V}$, $-1\text{ mA} \leq I_{OUT} \leq 1\text{ mA}$
f_{ADC}	Internal ADC Frequency	-	120	128	140	kHz	$T_J = 25\text{ }^\circ\text{C}$
f_{ADC}	Internal ADC Frequency over Temperature Range	-	110	128	150	kHz	$V_{DD} = 4.5\text{ V}$ to 8.5 V
$t_{r(O)}$	Response Time of Output	3	-	5 4 2 1	10 8 4 2	ms ms ms ms	3 dB Filter frequency = 80 Hz 3 dB Filter frequency = 160 Hz 3 dB Filter frequency = 500 Hz 3 dB Filter frequency = 2 kHz $C_L = 10\text{ nF}$, time from 10% to 90% of final output voltage for a steplike signal B_{step} from 0 mT to B_{max}
$t_{d(O)}$	Delay Time of Output	3		0.1	0.5	ms	$C_L = 10\text{ nF}$
t_{POD}	Power-Up Time (Time to reach stabilized Output Voltage)			6 5 3 2	11 9 5 3	ms ms ms ms	3 dB Filter frequency = 80 Hz 3 dB Filter frequency = 160 Hz 3 dB Filter frequency = 500 Hz 3 dB Filter frequency = 2 kHz $C_L = 10\text{ nF}$, 90% of V_{OUT}
BW	Small Signal Bandwidth (-3 dB)	3	-	2	-	kHz	$B_{AC} < 10\text{ mT}$; 3 dB Filter frequency = 2 kHz
V_{OUTn}	Noise Output Voltage _{pp}	3	-	3	6	mV	²⁾ magnetic range = 90 mT
R_{OUT}	Output Resistance over Recommended Operating Range	3	-	1	10	Ω	$V_{OUTLmax} \leq V_{OUT} \leq V_{OUTHmin}$
R_{thJA} TO-92UT	Thermal Resistance Junction to Soldering Point	-	-	150	200	K/W	

¹⁾ Output DAC full scale = 5 V ratiometric, Output DAC offset = 0 V, Output DAC LSB = $V_{DD}/4096$
²⁾ peak-to-peak value exceeded: 5%
³⁾ if more than 50% of the selected magnetic field range are used

3.7. Magnetic Characteristics

at $T_J = -40\text{ °C}$ to $+170\text{ °C}$, $V_{DD} = 4.5\text{ V}$ to 5.5 V , after programming, as not otherwise specified in Conditions.
 Typical Characteristics for $T_J = 25\text{ °C}$ and $V_{DD} = 5\text{ V}$.

Symbol	Parameter	Pin No.	Min.	Typ.	Max.	Unit	Test Conditions
B_{Offset}	Magnetic Offset	3	-1	0	1	mT	$B = 0\text{ mT}$, $I_{\text{OUT}} = 0\text{ mA}$, $T_J = 25\text{ °C}$
$\Delta B_{\text{Offset}}/\Delta T$	Magnetic Offset Change due to T_J		-15	0	15	$\mu\text{T/K}$	$B = 0\text{ mT}$, $I_{\text{OUT}} = 0\text{ mA}$
$B_{\text{Hysteresis}}$	Magnetic Hysteresis		-20	0	20	μT	Range = 30 mT, Filter = 500 Hz
SR	Magnetic Slew Rate	3	-	2 4 12 25 50	-	mT/ms	Filter frequency = 80 Hz Filter frequency = 160 Hz Filter frequency = 500 Hz Filter frequency = 1 kHz Filter frequency = 2 kHz
n_{meff}	Magnetic RMS Broadband Noise	3	-	10	-	μT	BW = 10 Hz to 2 kHz
f_{Cflicker}	Corner Frequency of 1/f Noise	3	-	20		Hz	$B = 0\text{ mT}$
f_{Cflicker}	Corner Frequency of 1/frms Noise	3	-	100		Hz	$B = 65\text{ mT}$, $T_J = 25\text{ °C}$

3.8. Open-Circuit Detection

at $T_J = -40\text{ °C}$ to $+170\text{ °C}$, Typical Characteristics for $T_J = 25\text{ °C}$

Symbol	Parameter	Pin No.	Min.	Typ.	Max.	Unit	Test Conditions
V_{OUT}	Output voltage at open V_{DD} line	3	0	0	0.2	V	$V_{DD} = 5\text{ V}$ $R_L = 10\text{ k}\Omega$ to GND
V_{OUT}	Output voltage at open GND line	3	4.7	4.8	5	V	$V_{DD} = 5\text{ V}$ $R_L = 10\text{ k}\Omega$ to GND

3.9. Overvoltage and Undervoltage Detection

at $T_J = -40\text{ °C}$ to $+170\text{ °C}$, Typical Characteristics for $T_J = 25\text{ °C}$

Symbol	Parameter	Pin No.	Min.	Typ.	Max.	Unit	Test Conditions
$V_{DD,UV}$	Undervoltage detection level	1	3.5	3.8	4.1	V	1)
$V_{DD,OV}$	Overvoltage detection level	1	8.5	9.2	10.0	V	1)

1) If the supply voltage drops below $V_{DD,UV}$ or rises above $V_{DD,OV}$, the output voltage is switched to V_{DD} ($\geq 94\%$ of V_{DD} at $R_L = 10\text{ k}\Omega$ to GND).

3.10. Typical Characteristics

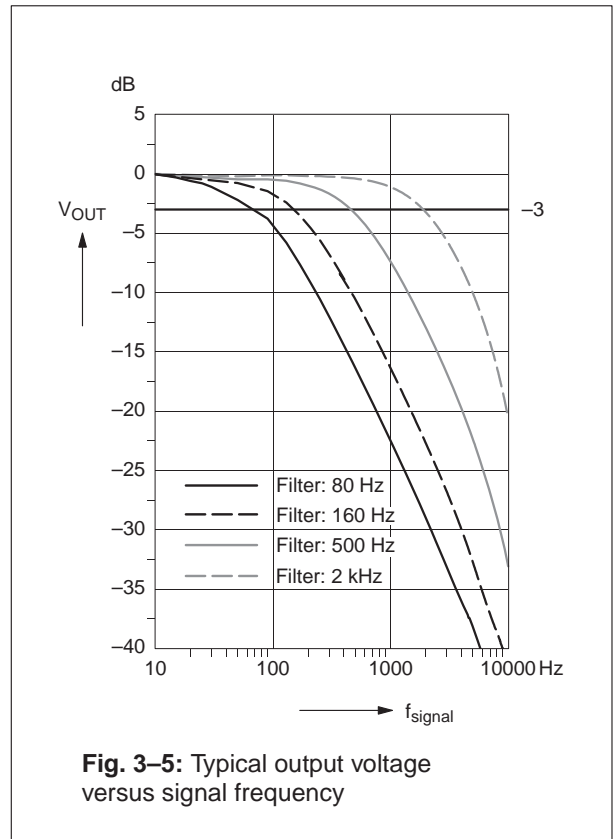
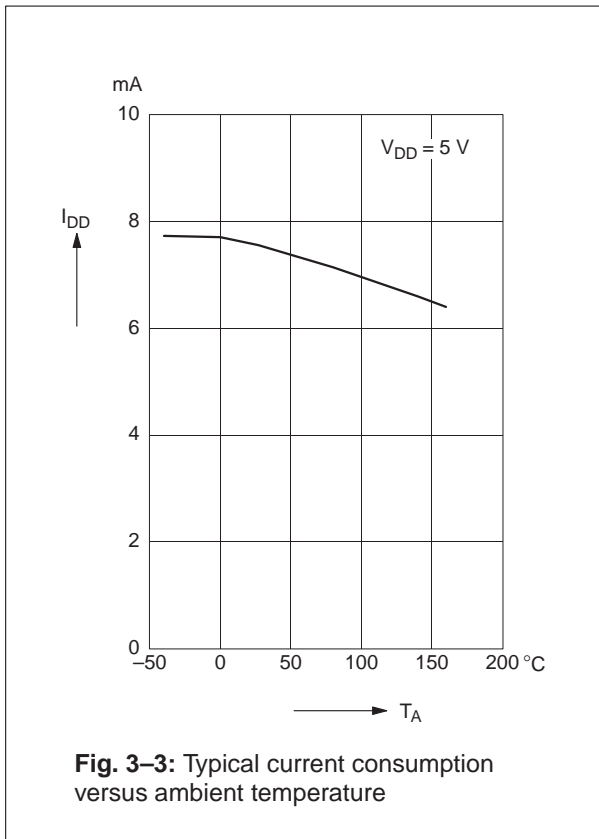
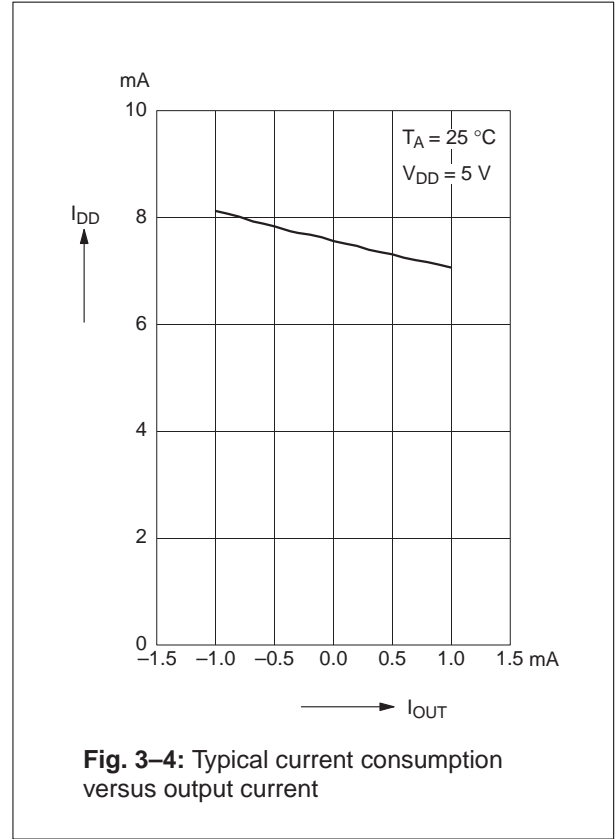
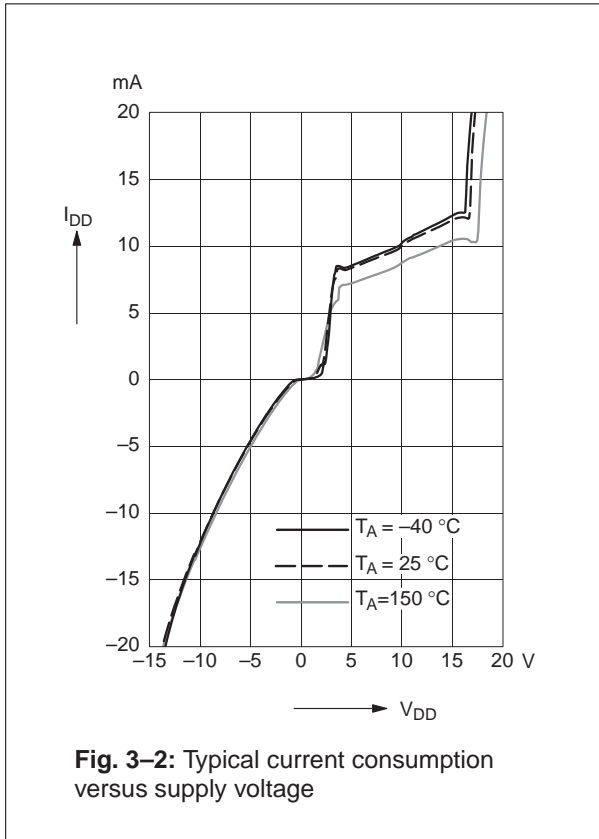

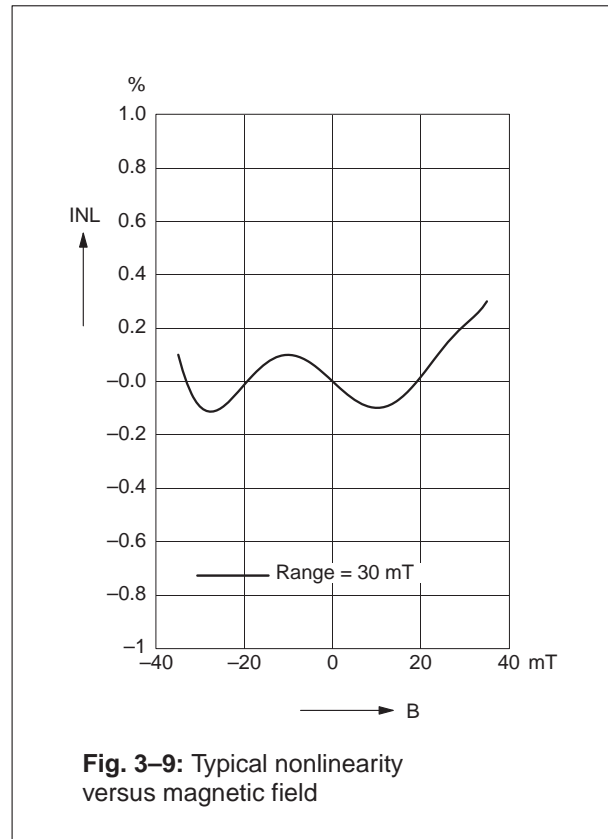
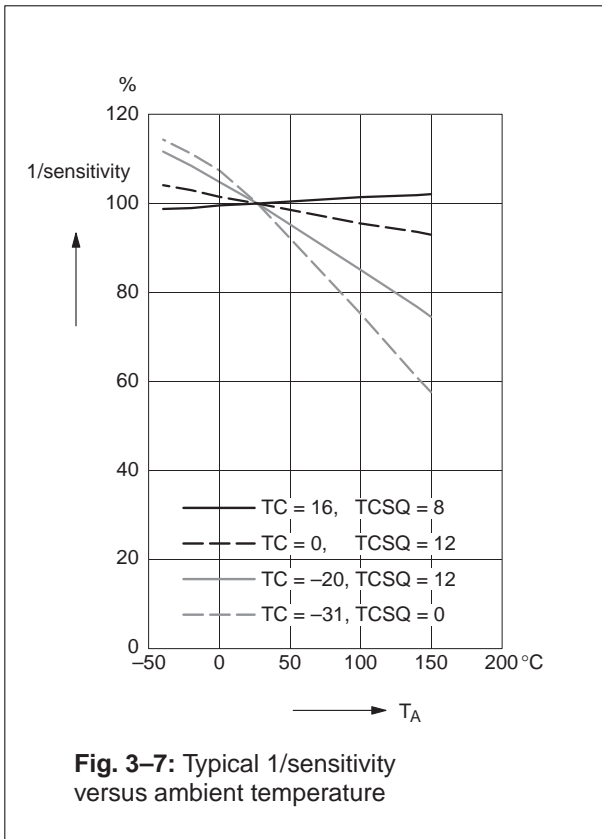
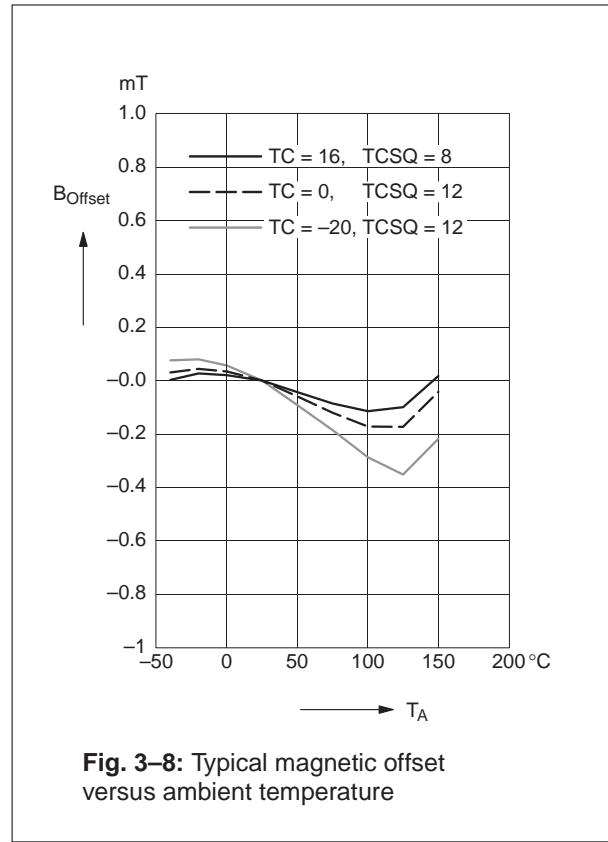
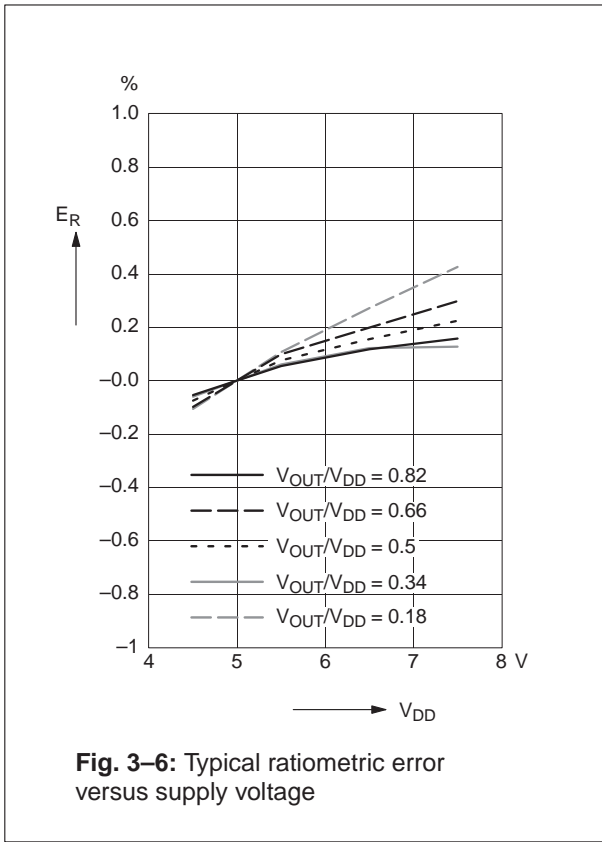

4. Application Notes

4.1. Application Circuit

For EMC protection, it is recommended to connect one ceramic 4.7 nF capacitor each between ground and the supply voltage, respectively the output voltage pin. In addition, the input of the controller unit should be pulled-down with a 4.7 kOhm resistor and a ceramic 4.7 nF capacitor.

Please note that during programming, the sensor will be supplied repeatedly with the programming voltage of 12 V for 100 ms. All components connected to the V_{DD} line at this time must be able to resist this voltage.

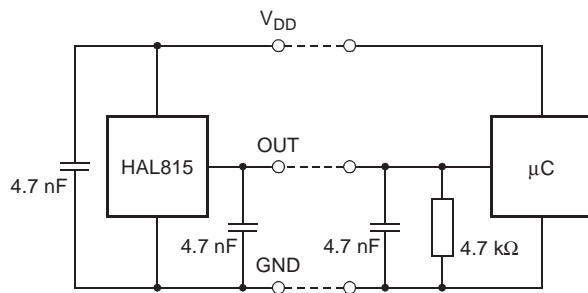

Fig. 4-1: Recommended application circuit

4.2. Use of two HAL 815 in Parallel

Two different HAL 815 sensors which are operated in parallel to the same supply and ground line can be programmed individually. In order to select the IC which should be programmed, both Hall ICs are inactivated by the “Deactivate” command on the common supply line. Then, the appropriate IC is activated by an “Activate” pulse on its output. Only the activated sensor will react to all following read, write, and program commands. If the second IC has to be programmed, the “Deactivate” command is sent again, and the second IC can be selected.

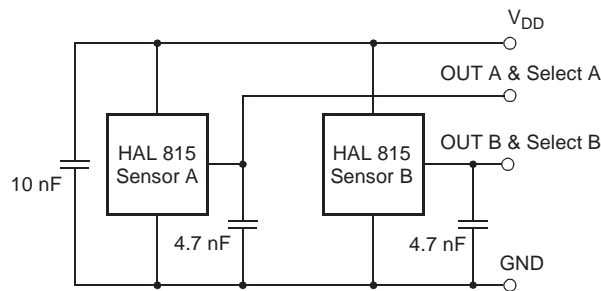

Fig. 4-2: Parallel operation of two HAL 815

4.3. Temperature Compensation

The relationship between the temperature coefficient of the magnet and the corresponding TC and TCSQ codes for linear compensation is given in the following table. In addition to the linear change of the magnetic field with temperature, the curvature can be adjusted as well. For this purpose, other TC and TCSQ combinations are required which are not shown in the table. Please contact Micronas for more detailed information on this higher order temperature compensation.

The HAL 800 and HAL 815 contain the same temperature compensation circuits. If an optimal setting for the HAL 800 is already available, the same settings may be used for the HAL 815.

Temperature Coefficient of Magnet (ppm/K)	TC	TCSQ
400	31	6
300	28	7
200	24	8
100	21	9
0	18	10
-50	17	10
-90	16	11
-130	15	11
-170	14	11
-200	13	12
-240	12	12
-280	11	12
-320	10	13
-360	9	13
-410	8	13
-450	7	13
-500	6	14
-550	5	14
-600	4	14
-650	3	14
-700	2	15
-750	1	15

Temperature Coefficient of Magnet (ppm/K)	TC	TCSQ
-810	0	15
-860	-1	16
-910	-2	16
-960	-3	16
-1020	-4	17
-1070	-5	17
-1120	-6	17
-1180	-7	18
-1250	-8	18
-1320	-9	19
-1380	-10	19
-1430	-11	20
-1500	-12	20
-1570	-13	20
-1640	-14	21
-1710	-15	21
-1780	-16	22
-1870	-17	22
-1950	-18	23
-2030	-19	23
-2100	-20	24
-2180	-21	24
-2270	-22	25
-2420	-24	26
-2500	-25	27
-2600	-26	27
-2700	-27	28
-2800	-28	28
-2900	-29	29
-3000	-30	30
-3100	-31	31

4.4. Undervoltage Behavior

In a voltage range below 4.5 V to approximately 3.5 V, the operation of the HAL 815 is typically given and predictable for the most sensors. Some of the parameters may be out of the specification. Below about 3.5 V, the digital processing is reset. If the supply voltage once again rises above about 3.5 V, a startup time of about 20 μs elapses for the digital processing to occur. As long as the supply voltage is still above about 2.8 V, the analog output is kept at its last valid value ratiometric to V_{DD}. Below about 2.5 V, the entire sensor will reset.

4.5. Ambient Temperature

Due to the internal power dissipation, the temperature on the silicon chip (junction temperature T_J) is higher than the temperature outside the package (ambient temperature T_A).

$$T_J = T_A + \Delta T$$

At static conditions, the following equation is valid:

$$\Delta T = I_{DD} * V_{DD} * R_{thJA}$$

For typical values, use the typical parameters. For worst case calculation, use the max. parameters for I_{DD} and R_{th}, and the max. value for V_{DD} from the application.

For V_{DD} = 5.5 V, R_{th} = 200 K/W and I_{DD} = 10 mA the temperature difference ΔT = 11 K.

For all sensors, the junction temperature T_J is specified. The maximum ambient temperature T_{Amax} can be calculated as:

$$T_{Amax} = T_{Jmax} - \Delta T$$

4.6. EMC and ESD

The HAL 815 is designed for a stabilized 5 V supply. Interferences and disturbances conducted along the 12 V onboard system (product standards DIN40839 part 1 or ISO 7637 part 1) are not relevant for these applications.

For applications with disturbances by capacitive or inductive coupling on the supply line or radiated disturbances, the application circuit shown in Fig. 4-1 is recommended. Applications with this arrangement passed the EMC tests according to the product standards DIN 40839 part 3 (Electrical transient transmission by capacitive or inductive coupling) and part 4 (Radiated disturbances).

Please contact Micronas for the detailed investigation reports with the EMC and ESD results.

5. Programming of the Sensor

5.1. Definition of Programming Pulses

The sensor is addressed by modulating a serial telegram on the supply voltage. The sensor answers with a serial telegram on the output pin.

The bits in the serial telegram have a different bit time for the V_{DD} -line and the output. The bit time for the V_{DD} -line is defined through the length of the Sync Bit at the beginning of each telegram. The bit time for the output is defined through the Acknowledge Bit.

A logical “0” is coded as no voltage change within the bit time. A logical “1” is coded as a voltage change between 50% and 80% of the bit time. After each bit, a voltage change occurs.

5.2. Definition of the Telegram

Each telegram starts with the Sync Bit (logical 0), 3 bits for the Command (COM), the Command Parity Bit (CP), 4 bits for the Address (ADR), and the Address Parity Bit (AP).

There are 4 kinds of telegrams:

- Write a register (see Fig. 5–2)
After the AP Bit, follow 14 Data Bits (DAT) and the Data Parity Bit (DP). If the telegram is valid and the command has been processed, the sensor answers with an Acknowledge Bit (logical 0) on the output.

- Read a register (see Fig. 5–3)
After evaluating this command, the sensor answers with the Acknowledge Bit, 14 Data Bits, and the Data Parity Bit on the output.
- Programming the EEPROM cells (see Fig. 5–4)
After evaluating this command, the sensor answers with the Acknowledge Bit. After the delay time t_w , the supply voltage rises up to the programming voltage.
- Activate a sensor (see Fig. 5–5)
If more than one sensor is connected to the supply line, selection can be done by first deactivating all sensors. The output of all sensors will be pulled to ground by the internal 10 k Ω resistors. With an Activate pulse on the appropriate output pin, an individual sensor can be selected. All following commands will only be accepted from the activated sensor.

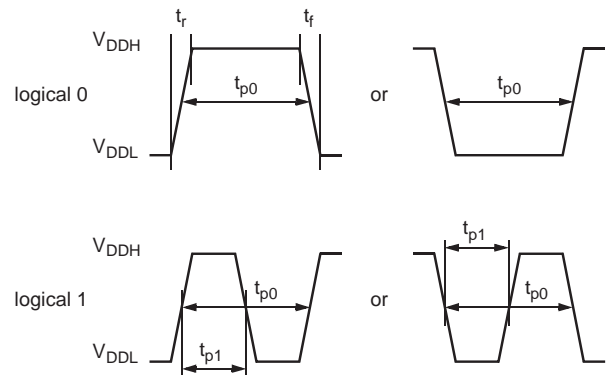

Fig. 5–1: Definition of logical 0 and 1 bit

Table 5–1: Telegram parameters

Symbol	Parameter	Pin	Min.	Typ.	Max.	Unit	Remarks
V_{DDL}	Supply Voltage for Low Level during Programming	1	5	5.6	6	V	
V_{DDH}	Supply Voltage for High Level during Programming	1	6.8	8.0	8.5	V	
t_r	Rise time	1			0.05	ms	
t_f	Fall time	1			0.05	ms	
t_{p0}	Bit time on V_{DD}	1	1.7	1.75	1.8	ms	t_{p0} is defined through the Sync Bit
t_{pOUT}	Bit time on output pin	3	2	3	4	ms	t_{pOUT} is defined through the Acknowledge Bit
t_{p1}	Voltage Change for logical 1	1, 3	50	65	80	%	% of t_{p0} or t_{pOUT}
V_{DDPROG}	Supply Voltage for Programming the EEPROM	1	11.95	12	12.1	V	
t_{PROG}	Programming Time for EEPROM	1	95	100	105	ms	

Table 5–1: Telegram parameters, continued

Symbol	Parameter	Pin	Min.	Typ.	Max.	Unit	Remarks
t_{rp}	Rise time of programming voltage	1	0.2	0.5	1	ms	
t_{fp}	Fall time of programming voltage	1	0		1	ms	
t_w	Delay time of programming voltage after Acknowledge	1	0.5	0.7	1	ms	
V_{act}	Voltage for an Activate pulse	3	3	4	5	V	
t_{act}	Duration of an Activate pulse	3	0.05	0.1	0.2	ms	

WRITE

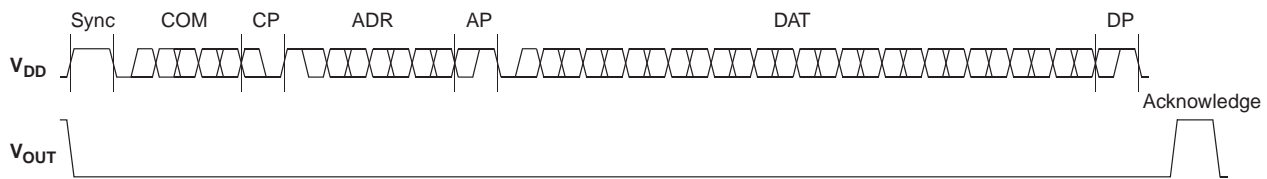

Fig. 5–2: Telegram for coding a Write command

READ

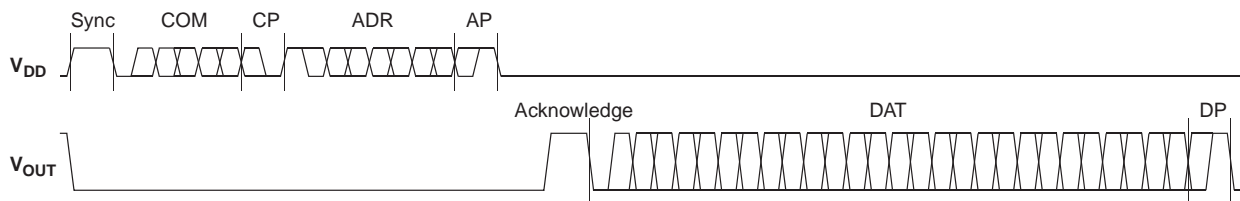

Fig. 5–3: Telegram for coding a Read command

ERASE, PROM, LOCK, and LOCKI

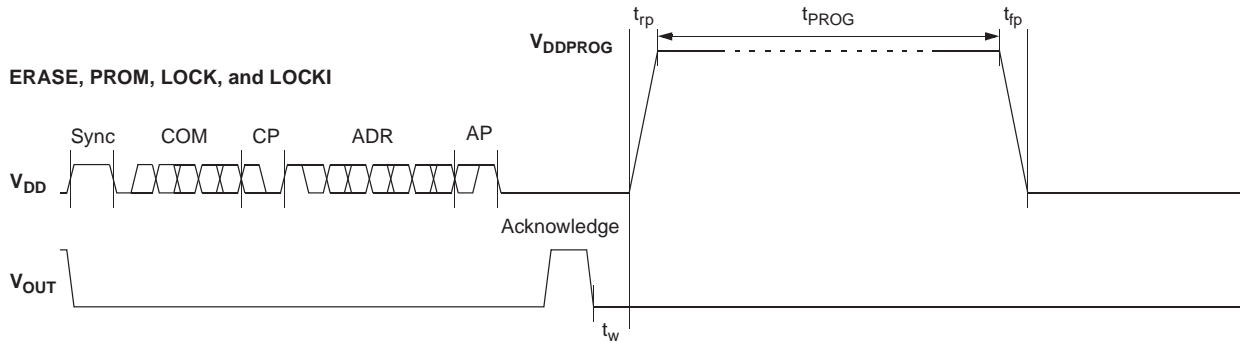

Fig. 5–4: Telegram for coding the EEPROM programming

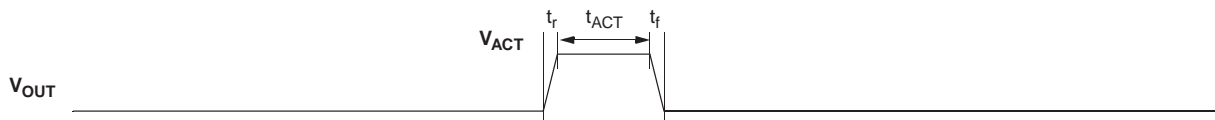

Fig. 5–5: Activate pulse

5.3. Telegram Codes

Sync Bit

Each telegram starts with the Sync Bit. This logical “0” pulse defines the exact timing for t_{p0} .

Command Bits (COM)

The Command code contains 3 bits and is a binary number. Table 5–2 shows the available commands and the corresponding codes for the HAL 815.

Command Parity Bit (CP)

This parity bit is “1” if the number of zeros within the 3 Command Bits is uneven. The parity bit is “0”, if the number of zeros is even.

Address Bits (ADR)

The Address code contains 4 bits and is a binary number. Table 5–3 shows the available addresses for the HAL 815 registers.

Address Parity Bit (AP)

This parity bit is “1” if the number of zeros within the 4 Address bits is uneven. The parity bit is “0” if the number of zeros is even.

Data Bits (DAT)

The 14 Data Bits contain the register information.

The registers use different number formats for the Data Bits. These formats are explained in Section 5.4.

In the Write command, the last bits are valid. If, for example, the TC register (6 bits) is written, only the last 6 bits are valid.

In the Read command, the first bits are valid. If, for example, the TC register (6 bits) is read, only the first 6 bits are valid.

Data Parity Bit (DP)

This parity bit is “1” if the number of zeros within the binary number is even. The parity bit is “0” if the number of zeros is uneven.

Acknowledge

After each telegram, the output answers with the Acknowledge signal. This logical “0” pulse defines the exact timing for t_{pOUT} .

Table 5–2: Available commands

Command	Code	Explanation
READ	2	read a register
WRITE	3	write a register
PROM	4	program all nonvolatile registers (except the lock bits)
ERASE	5	erase all nonvolatile registers (except the lock bits)
LOCKI	6	lock Micronas lockable register
LOCK	7	lock the whole device and switch permanently to the analog-mode
Please note: The Micronas lock bit (LOCKI) has already been set during production and cannot be reset.		

5.4. Number Formats

Binary number:

The most significant bit is given as first, the least significant bit as last digit.

Example: 101001 represents 41 decimal.

Signed binary number:

The first digit represents the sign of the following binary number (1 for negative, 0 for positive sign).

Example: 0101001 represents +41 decimal
 1101001 represents -41 decimal

Two-complementary number:

The first digit of positive numbers is “0”, the rest of the number is a binary number. Negative numbers start with “1”. In order to calculate the absolute value of the number, calculate the complement of the remaining digits and add “1”.

Example: 0101001 represents +41 decimal
 1010111 represents -41 decimal

Table 5–3: Available register addresses

Register	Code	Data Bits	Format	Customer	Remark
CLAMP-LOW	1	10	binary	read/write/program	Low clamping voltage
CLAMP-HIGH	2	11	binary	read/write/program	High clamping voltage
VOQ	3	11	two compl. binary	read/write/program	
SENSITIVITY	4	14	signed binary	read/write/program	
MODE	5	6	binary	read/write/program	Range and filter settings
LOCKR	6	1	binary	lock	Lock Bit
ADC-READOUT	7	14	two compl. binary	read	
TC	11	6	signed binary	read/write/program	
TCSQ	12	5	binary	read/write/program	
DEACTIVATE	15	12	binary	write	Deactivate the sensor

Micronas registers (read only for customers)

Register	Code	Data Bits	Format	Remark
OFFSET	8	4	two compl. binary	ADC offset adjustment
FOSCAD	9	5	binary	Oscillator frequency adjustment
SPECIAL	13	6		special settings
IMLOCK	14	1	binary	Lock Bit for the Micronas registers

5.5. Register Information

CLAMP-LOW

- The register range is from 0 up to 1023.
- The register value is calculated by:

$$CLAMP-LOW = \frac{Low\ Clamping\ Voltage}{V_{DD}} * 2048$$

CLAMP-HIGH

- The register range is from 0 up to 2047.
- The register value is calculated by:

$$CLAMP-HIGH = \frac{High\ Clamping\ Voltage}{V_{DD}} * 2048$$

VOQ

- The register range is from –1024 up to 1023.
- The register value is calculated by:

$$VOQ = \frac{V_{OQ}}{V_{DD}} * 1024$$

SENSITIVITY

- The register range is from –8192 up to 8191.
- The register value is calculated by:

$$SENSITIVITY = \frac{Sensitivity}{2048}$$

TC and TCSQ

- The TC register range is from –31 up to 31.
- The TCSQ register range is from 0 up to 31.

Please refer Section 4.2. on page 17 for the recommended values.

MODE

- The register range is from 0 up to 63 and contains the settings for FILTER and RANGE:

$$MODE = FILTER * 8 + RANGE$$

Please refer Section 2.2. on page 7 for the available FILTER and RANGE values.

ADC-READOUT

- This register is read only.
- The register range is from –8192 up to 8191.

DEACTIVATE

- This register can only be written.
- The register has to be written with 2063 decimal (80F hexadecimal) for the deactivation.
- The sensor can be reset with an Activate pulse on the output pin or by switching off and on the supply voltage.

5.6. Programming Information

If the content of any register (except the lock registers) is to be changed, the desired value must first be written into the corresponding RAM register. Before reading out the RAM register again, the register value must be permanently stored in the EEPROM.

Permanently storing a value in the EEPROM is done by first sending an ERASE command followed by sending a PROM command. The address within the ERASE and PROM commands is not important. ERASE and PROM act on all registers in parallel.

If all HAL 815 registers are to be changed, all writing commands can be sent one after the other, followed by sending one ERASE and PROM command at the end.

6. Data Sheet History

1. Advance Information:
"HAL 815 Programmable Linear Hall Effect Sensor",
Nov. 10, 2000, 6251-537-1AI.
First release of the advance information.

Micronas GmbH
Hans-Bunte-Strasse 19
D-79108 Freiburg (Germany)
P.O. Box 840
D-79008 Freiburg (Germany)
Tel. +49-761-517-0
Fax +49-761-517-2174
E-mail: docservice@micronas.com
Internet: www.micronas.com

Printed in Germany
Order No. 6251-537-1AI



All information and data contained in this data sheet are without any commitment, are not to be considered as an offer for conclusion of a contract, nor shall they be construed as to create any liability. Any new issue of this data sheet invalidates previous issues. Product availability and delivery are exclusively subject to our respective order confirmation form; the same applies to orders based on development samples delivered. By this publication, Micronas GmbH does not assume responsibility for patent infringements or other rights of third parties which may result from its use.

Further, Micronas GmbH reserves the right to revise this publication and to make changes to its content, at any time, without obligation to notify any person or entity of such revisions or changes.

No part of this publication may be reproduced, photocopied, stored on a retrieval system, or transmitted without the express written consent of Micronas GmbH.

Looking for pricing, stock, or lifecycle information?

Click below to explore more details on WIN SOURCE:

-  [View HAL815 UT-A on WIN SOURCE](#)
-  [Micronas GmbH Information](#)

Optimize Your Supply Chain with WIN SOURCE Solutions

-  Global Sourcing Solution
-  Obsolete Management
-  Cost Control Management
-  Shortage Management
-  Alternative Solution
-  Excess Inventory Management