



THE DATASHEET OF AOI11S60



General Description

The AOD11S60 & AOI11S60 have been fabricated using the advanced α MOS™ high voltage process that is designed to deliver high levels of performance and robustness in switching applications. By providing low $R_{DS(ON)}$, Q_g and E_{OSS} along with guaranteed avalanche capability these parts can be adopted quickly into new and existing offline power supply designs.

Product Summary

$V_{DS} @ T_{j,max}$	700V
I_{DM}	45A
$R_{DS(ON),max}$	0.399 Ω
$Q_{g,typ}$	11nC
$E_{OSS} @ 400V$	2.7 μ J

100% UIS Tested
 100% R_g Tested

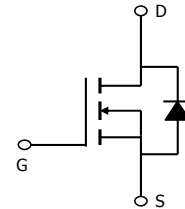
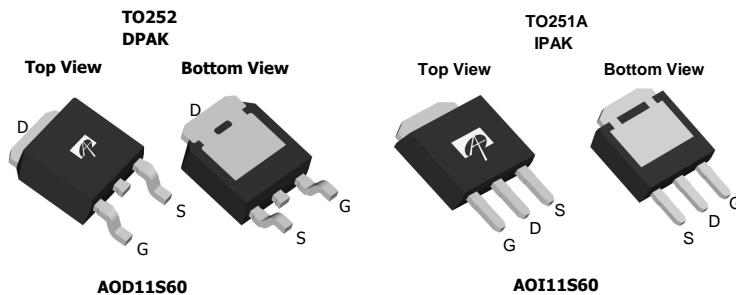
Absolute Maximum Ratings $T_A=25^\circ\text{C}$ unless otherwise noted

Parameter	Symbol	Maximum	Units
Drain-Source Voltage	V_{DS}	600	V
Gate-Source Voltage	V_{GS}	± 30	V
Continuous Drain Current	I_D	$T_C=25^\circ\text{C}$	11
		$T_C=100^\circ\text{C}$	8.5
Pulsed Drain Current ^C	I_{DM}	45	A
Avalanche Current ^C	I_{AR}	2	A
Repetitive avalanche energy ^C	E_{AR}	60	mJ
Single pulsed avalanche energy ^H	E_{AS}	120	mJ
Power Dissipation ^B	P_D	$T_C=25^\circ\text{C}$	208
		Derate above 25°C	1.67
MOSFET dv/dt ruggedness	dv/dt	100	V/ns
Peak diode recovery dv/dt		20	
Junction and Storage Temperature Range	T_J, T_{STG}	-55 to 150	$^\circ\text{C}$
Maximum lead temperature for soldering purpose, 1/8" from case for 5 seconds ^K	T_L	300	$^\circ\text{C}$

Thermal Characteristics

Parameter	Symbol	Typical	Maximum	Units
Maximum Junction-to-Ambient ^{A,D}	$R_{\theta JA}$	45	55	$^\circ\text{C}/\text{W}$
Maximum Case-to-sink ^A	$R_{\theta CS}$	--	0.5	$^\circ\text{C}/\text{W}$
Maximum Junction-to-Case ^{D,F}	$R_{\theta JC}$	0.45	0.6	$^\circ\text{C}/\text{W}$

Electrical Characteristics (T_J=25°C unless otherwise noted)

Symbol	Parameter	Conditions	Min	Typ	Max	Units
STATIC PARAMETERS						
BV _{DSS}	Drain-Source Breakdown Voltage	I _D =250μA, V _{GS} =0V, T _J =25°C	600	-	-	V
		I _D =250μA, V _{GS} =0V, T _J =150°C	650	700	-	
I _{DSS}	Zero Gate Voltage Drain Current	V _{DS} =600V, V _{GS} =0V	-	-	1	μA
		V _{DS} =480V, T _J =150°C	-	10	-	
I _{GSS}	Gate-Body leakage current	V _{DS} =0V, V _{GS} =±30V	-	-	±100	nA
V _{GS(th)}	Gate Threshold Voltage	V _{DS} =5V, I _D =250μA	2.8	3.5	4.1	V
R _{DS(ON)}	Static Drain-Source On-Resistance	V _{GS} =10V, I _D =3.8A, T _J =25°C	-	0.35	0.399	Ω
		V _{GS} =10V, I _D =3.8A, T _J =150°C	-	0.98	1.11	Ω
V _{SD}	Diode Forward Voltage	I _S =5.5A, V _{GS} =0V, T _J =25°C	-	0.84	-	V
I _S	Maximum Body-Diode Continuous Current		-	-	11	A
I _{SM}	Maximum Body-Diode Pulsed Current ^C		-	-	45	A
DYNAMIC PARAMETERS						
C _{ISS}	Input Capacitance	V _{GS} =0V, V _{DS} =100V, f=1MHz	-	545	-	pF
C _{OSS}	Output Capacitance		-	37.3	-	pF
C _{O(er)}	Effective output capacitance, energy related ^I	V _{GS} =0V, V _{DS} =0 to 480V, f=1MHz	-	30.8	-	pF
C _{O(tr)}	Effective output capacitance, time related ^J		-	93.6	-	pF
C _{rSS}	Reverse Transfer Capacitance	V _{GS} =0V, V _{DS} =100V, f=1MHz	-	1.42	-	pF
R _g	Gate resistance	V _{GS} =0V, V _{DS} =0V, f=1MHz	-	16.5	-	Ω
SWITCHING PARAMETERS						
Q _g	Total Gate Charge	V _{GS} =10V, V _{DS} =480V, I _D =5.5A	-	11	-	nC
Q _{gs}	Gate Source Charge		-	2.8	-	nC
Q _{gd}	Gate Drain Charge		-	3.8	-	nC
t _{D(on)}	Turn-On Delay Time	V _{GS} =10V, V _{DS} =400V, I _D =5.5A, R _G =25Ω	-	20	-	ns
t _r	Turn-On Rise Time		-	20	-	ns
t _{D(off)}	Turn-Off Delay Time		-	59	-	ns
t _f	Turn-Off Fall Time		-	20	-	ns
t _{rr}	Body Diode Reverse Recovery Time	I _F =5.5A, di/dt=100A/μs, V _{DS} =400V	-	250	-	ns
I _{rm}	Peak Reverse Recovery Current	I _F =5.5A, di/dt=100A/μs, V _{DS} =400V	-	21	-	A
Q _{rr}	Body Diode Reverse Recovery Charge	I _F =5.5A, di/dt=100A/μs, V _{DS} =400V	-	3.3	-	μC

A. The value of R_{θJA} is measured with the device in a still air environment with T_A=25°C.

B. The power dissipation P_D is based on T_{J(MAX)}=150°C, using junction-to-case thermal resistance, and is more useful in setting the upper dissipation limit for cases where additional heatsinking is used.

C. Repetitive rating, pulse width limited by junction temperature T_{J(MAX)}=150°C. Ratings are based on low frequency and duty cycles to keep initial T_J=25°C.

D. The R_{θJA} is the sum of the thermal impedance from junction to case R_{θJC} and case to ambient.

E. The static characteristics in Figures 1 to 6 are obtained using <300 μs pulses, duty cycle 0.5% max.

F. These curves are based on the junction-to-case thermal impedance which is measured with the device mounted to a large heatsink, assuming a maximum junction temperature of T_{J(MAX)}=150°C. The SOA curve provides a single pulse rating.

G. These tests are performed with the device mounted on 1 in² FR-4 board with 2oz. Copper, in a still air environment with T_A=25°C.

H. L=60mH, I_{AS}=2A, V_{DD}=150V, Starting T_J=25°C

I. C_{O(er)} is a fixed capacitance that gives the same stored energy as C_{OSS} while V_{DS} is rising from 0 to 80% V_{(BR)DSS}.

J. C_{O(tr)} is a fixed capacitance that gives the same charging time as C_{OSS} while V_{DS} is rising from 0 to 80% V_{(BR)DSS}.

K. Wave soldering only allowed at leads.

THIS PRODUCT HAS BEEN DESIGNED AND QUALIFIED FOR THE CONSUMER MARKET. APPLICATIONS OR USES AS CRITICAL COMPONENTS IN LIFE SUPPORT DEVICES OR SYSTEMS ARE NOT AUTHORIZED. AOS DOES NOT ASSUME ANY LIABILITY ARISING OUT OF SUCH APPLICATIONS OR USES OF ITS PRODUCTS. AOS RESERVES THE RIGHT TO IMPROVE PRODUCT DESIGN, FUNCTIONS AND RELIABILITY WITHOUT NOTICE.

TYPICAL ELECTRICAL AND THERMAL CHARACTERISTICS

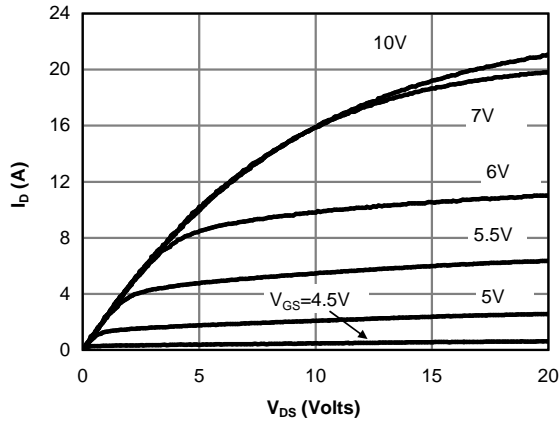

Figure 1: On-Region Characteristics @ 25°C

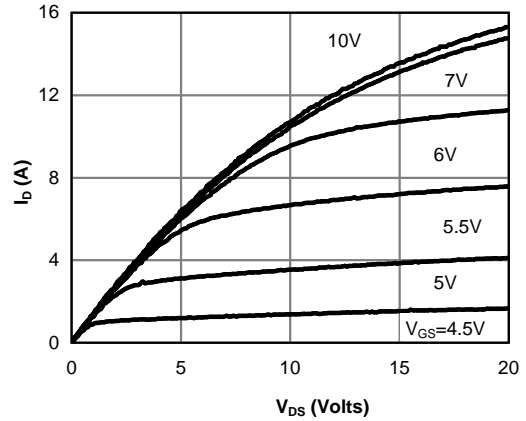

Figure 2: On-Region Characteristics @ 125°C

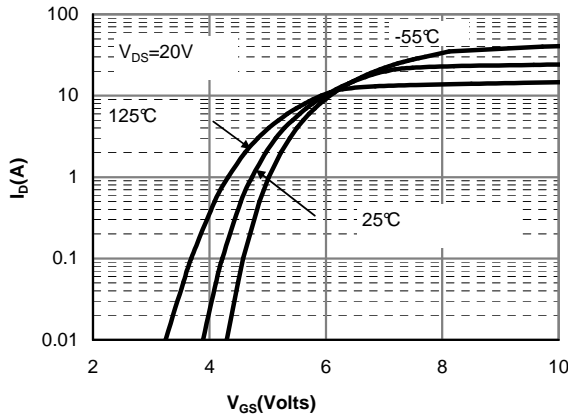

Figure 3: Transfer Characteristics

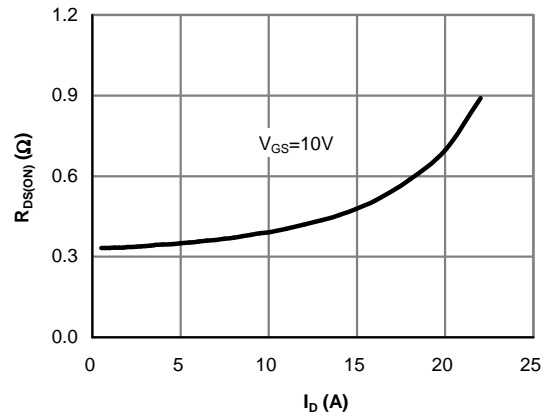

Figure 4: On-Resistance vs. Drain Current and Gate Voltage

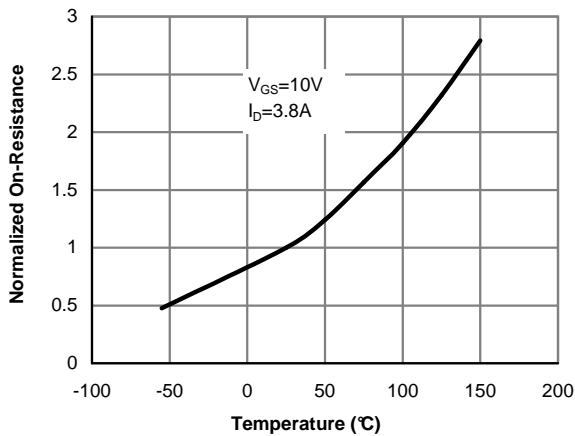

Figure 5: On-Resistance vs. Junction Temperature

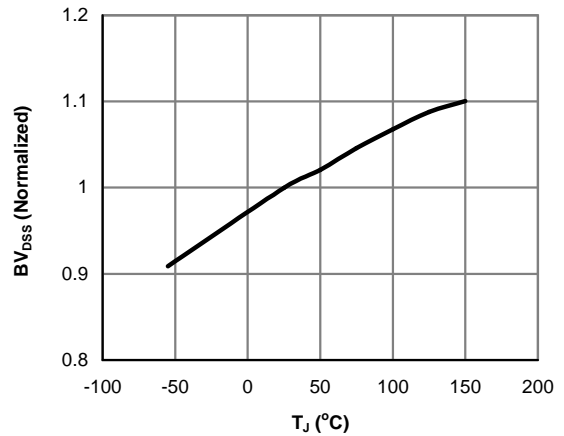

Figure 6: Break Down vs. Junction Temperature

TYPICAL ELECTRICAL AND THERMAL CHARACTERISTICS

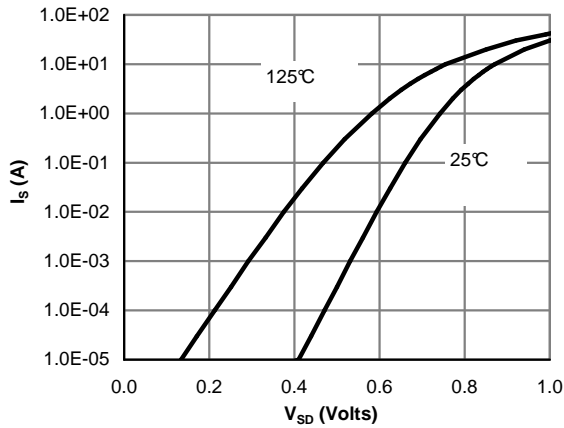

Figure 7: Body-Diode Characteristics (Note E)

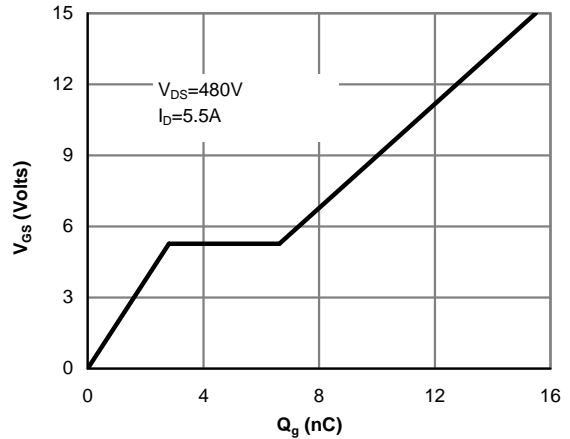

Figure 8: Gate-Charge Characteristics

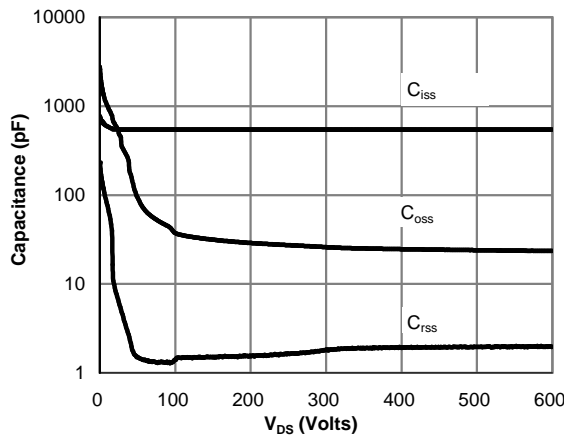

Figure 9: Capacitance Characteristics

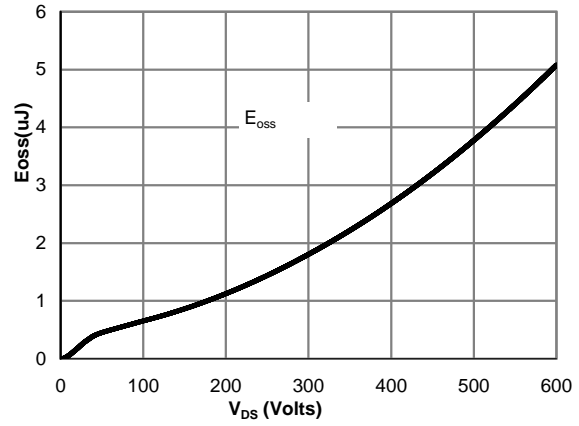

Figure 10: Coss stored Energy

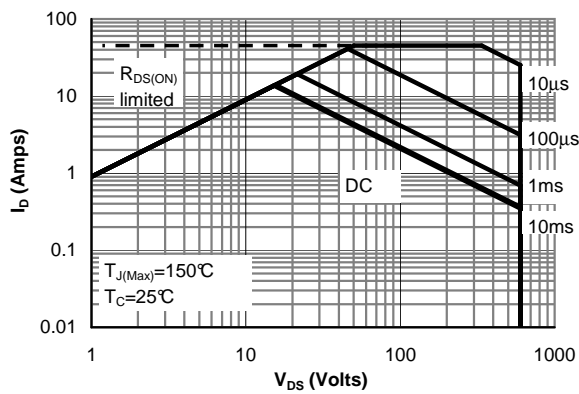

Figure 11: Maximum Forward Biased Safe Operating Area (Note F)

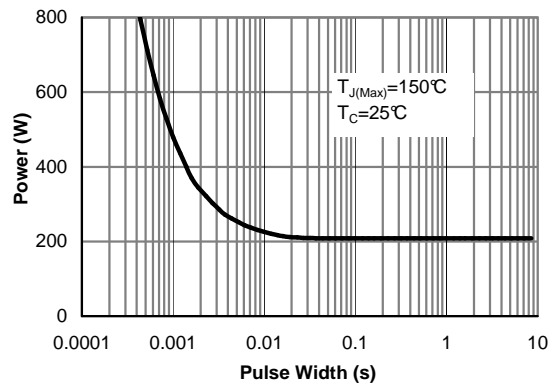

Figure 12: Single Pulse Power Rating Junction-to-Case (Note F)

TYPICAL ELECTRICAL AND THERMAL CHARACTERISTICS

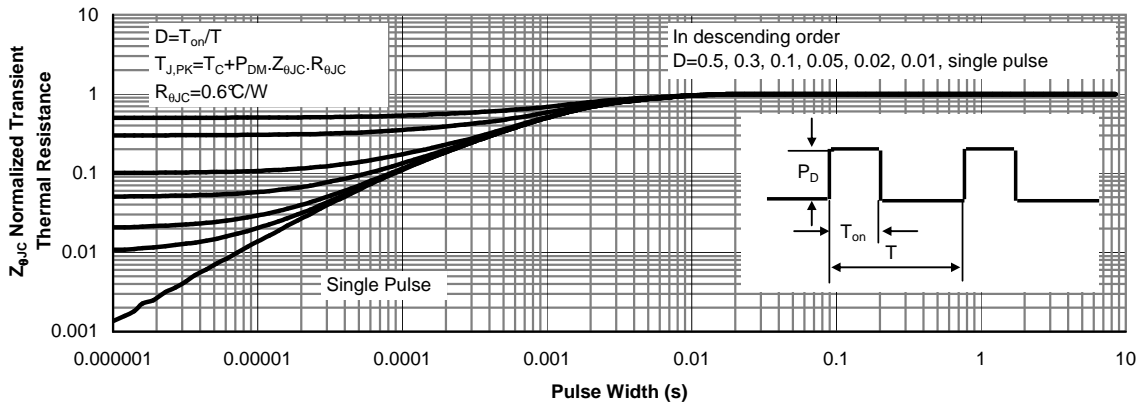

Figure 13: Normalized Maximum Transient Thermal Impedance (Note F)

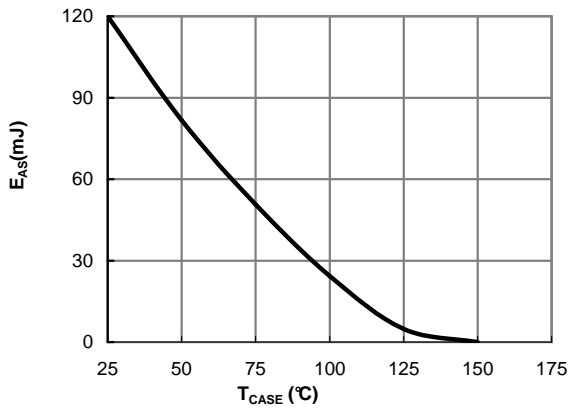

Figure 14: Avalanche energy

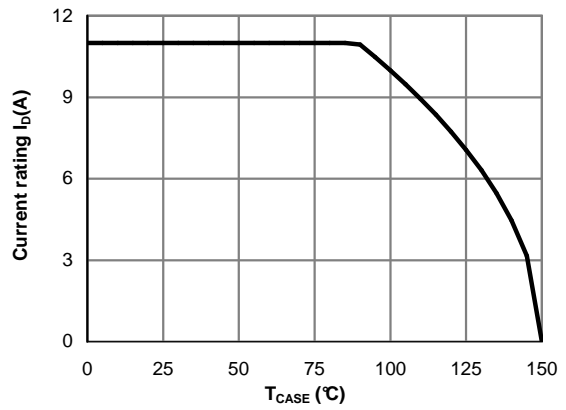

Figure 15: Current De-rating (Note B)

TYPICAL ELECTRICAL AND THERMAL CHARACTERISTICS

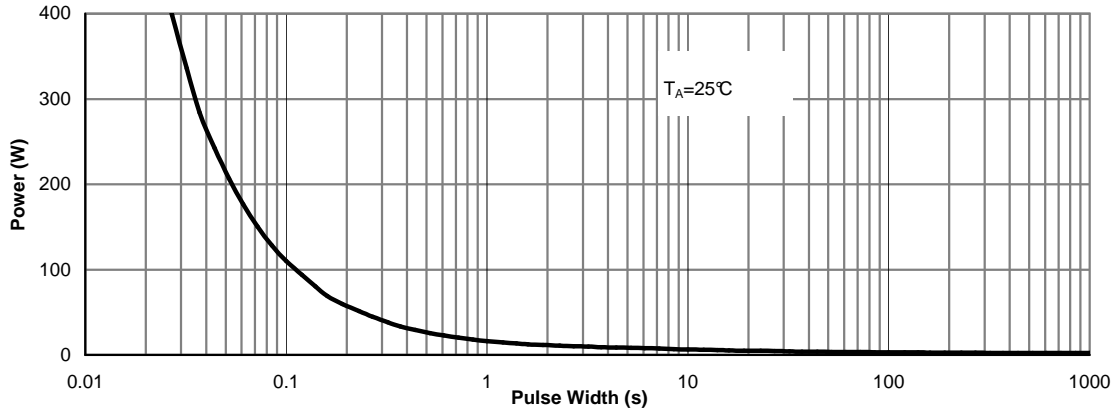

Figure 16: Single Pulse Power Rating Junction-to-Ambient (Note G)

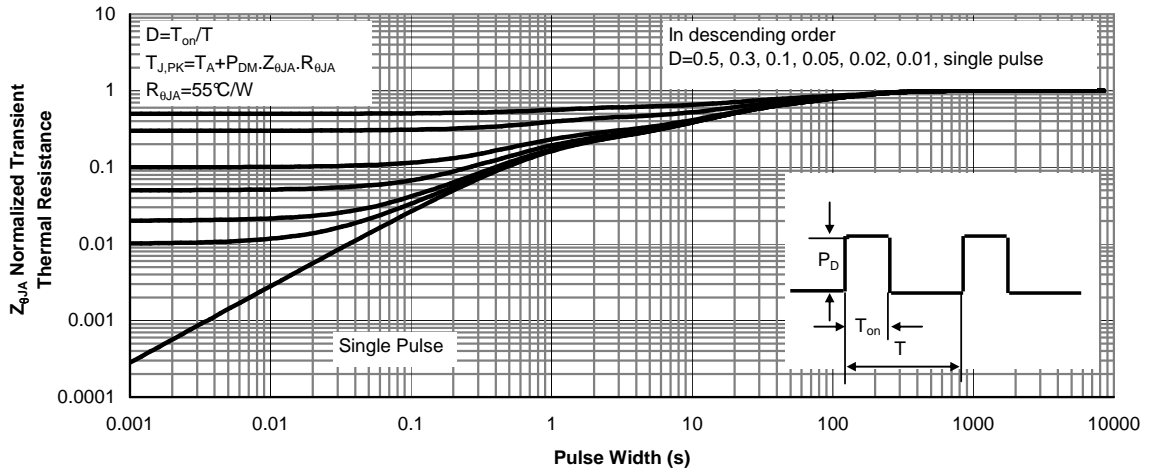
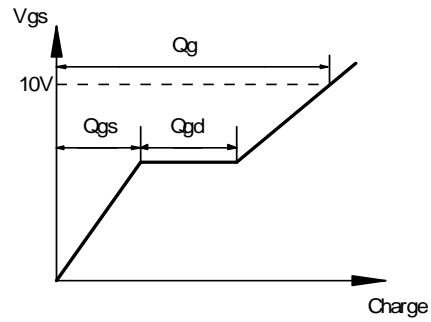
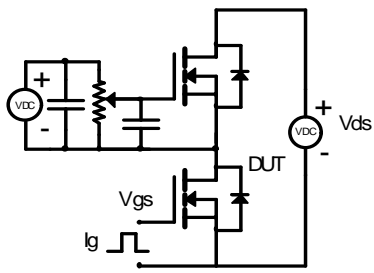
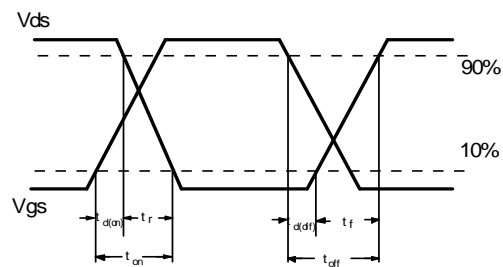
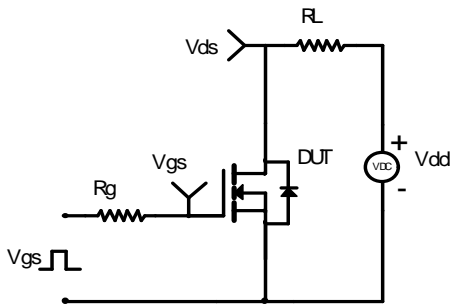

Figure 17: Normalized Maximum Transient Thermal Impedance (Note G)

Gate Charge Test Circuit & Waveform



Resistive Switching Test Circuit & Waveforms



Unclamped Inductive Switching (UIS) Test Circuit & Waveforms

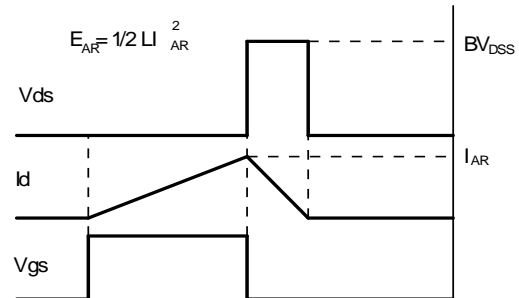
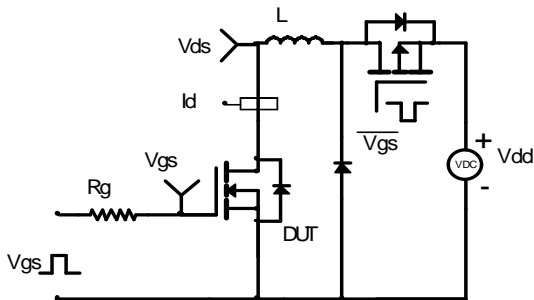

Diode Recovery Test Circuit & Waveforms

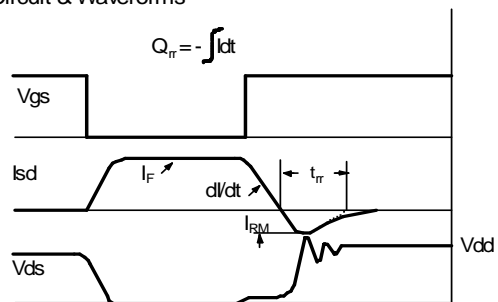
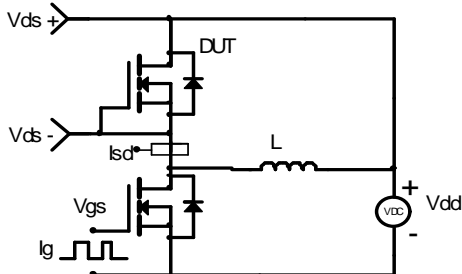

Looking for pricing, stock, or lifecycle information?

Click below to explore more details on WIN SOURCE:

- [View AOI11S60 on WIN SOURCE](#)
- [Alpha & Omega Semiconductor Inc. Information](#)

Optimize Your Supply Chain with WIN SOURCE Solutions

- ✓ Global Sourcing Solution
- ✓ Obsolete Management
- ✓ Cost Control Management
- ✓ Shortage Management
- ✓ Alternative Solution
- ✓ Excess Inventory Management