

# 2SK0664 (2SK664)

## Silicon N-channel MOSFET

For switching circuits

### ■ Features

- High-speed switching
- S-mini type package, allowing downsizing of the sets and automatic insertion through the tape/magazine packing

### ■ Absolute Maximum Ratings $T_a = 25^\circ\text{C}$

Parameter	Symbol	Rating	Unit
Drain-source surrender voltage	$V_{DSS}$	50	V
Gate-source voltage (Drain open)	$V_{GSO}$	8	V
Drain current	$I_D$	100	mA
Peak drain current	$I_{DP}$	200	mA
Power dissipation	$P_D$	150	mW
Channel temperature	$T_{ch}$	150	$^\circ\text{C}$
Storage temperature	$T_{stg}$	-55 to +150	$^\circ\text{C}$

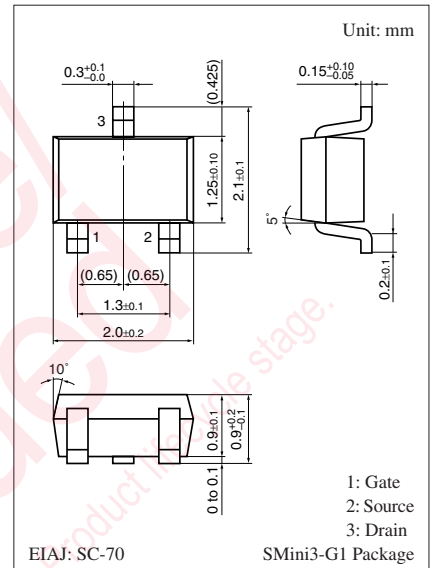

Marking Symbol: 3N

Internal Connection

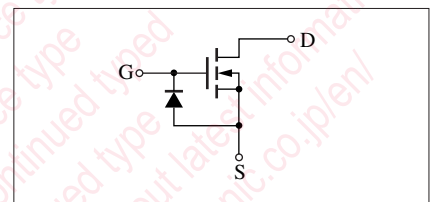

### ■ Electrical Characteristics $T_a = 25^\circ\text{C} \pm 3^\circ\text{C}$

Parameter	Symbol	Conditions	Min	Typ	Max	Unit
Drain-source surrender voltage	$V_{DSS}$	$I_D = 100 \mu\text{A}$ , $V_{GS} = 0$	50			V
Drain-source cutoff current	$I_{DSS}$	$V_{DS} = 10 \text{ V}$ , $V_{GS} = 0$			10	$\mu\text{A}$
Gate-source cutoff current	$I_{GSS}$	$V_{GS} = 8 \text{ V}$ , $V_{DS} = 0$			50	nA
Gate threshold voltage	$V_{th}$	$I_D = 100 \mu\text{A}$ , $V_{DS} = V_{GS}$	1.5		3.5	V
Forward transfer admittance	$ Y_{fs} $	$I_D = 20 \text{ mA}$ , $V_{DS} = 5 \text{ V}$ , $f = 1 \text{ kHz}$	20			mS
Drain-source ON resistance	$R_{DS(on)}$	$I_D = 20 \text{ mA}$ , $V_{GS} = 5 \text{ V}$			50	$\Omega$
Short-circuit forward transfer capacitance (Common source)	$C_{iss}$	$V_{DS} = 5 \text{ V}$ , $V_{GS} = 0$ , $f = 1 \text{ MHz}$			15	pF
Short-circuit output capacitance (Common source)	$C_{oss}$				5.0	pF
Reverse transfer capacitance (Common source)	$C_{rss}$				1.0	pF
Turn-on time <sup>*1,2</sup>	$t_{on}$	$V_{DD} = 5 \text{ V}$ , $V_{GS} = 0 \text{ V} \sim 5 \text{ V}$ , $R_L = 200 \Omega$		10		ns
Turn-off time <sup>*1,2</sup>	$t_{off}$	$V_{DD} = 5 \text{ V}$ , $V_{GS} = 5 \text{ V} \sim 0 \text{ V}$ , $R_L = 200 \Omega$		20		ns

Note) 1. Measuring methods are based on JAPANESE INDUSTRIAL STANDARD JIS C 7030 measuring methods for transistors.

2. Observe precautions for handling. Electrostatic sensitive devices.

Note) The part number in the parenthesis shows conventional part number.

■ Electrical Characteristics (continue)

Note) (continue)

3. \*1: Pulse measurement

\*2:  $t_{on}$ ,  $t_{off}$  test circuit

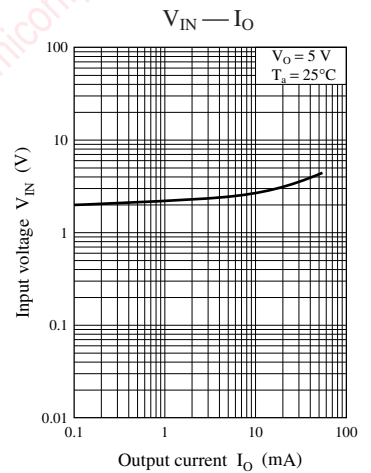
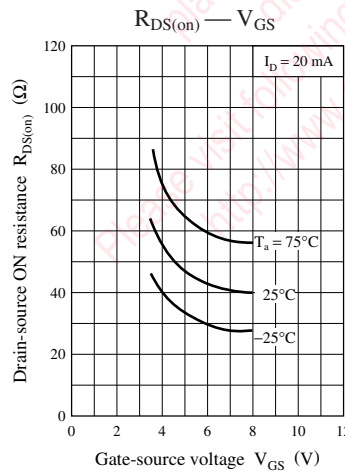
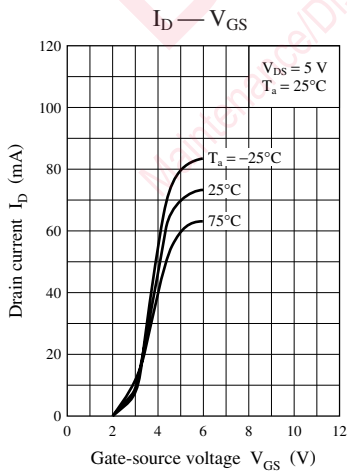
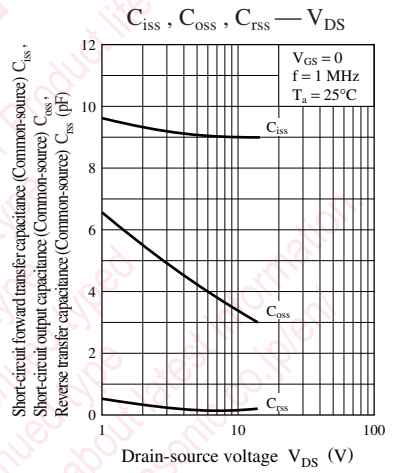
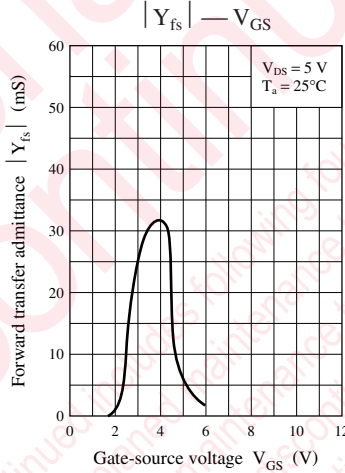
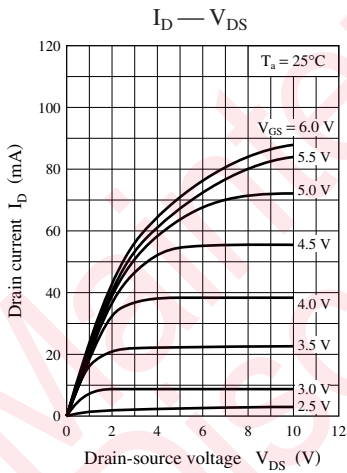
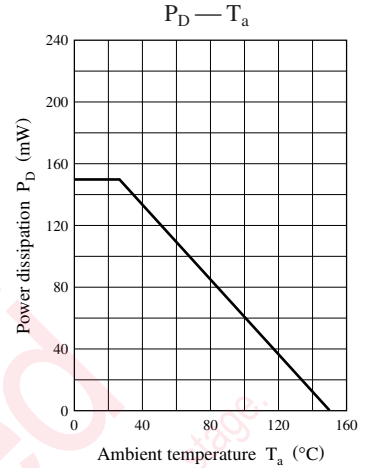
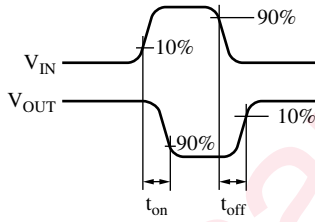
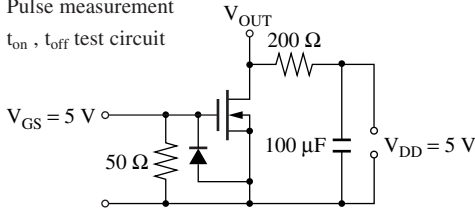

## utions in using the technical information and scribed in this book

s book is to be exported or provided to non-residents, the laws and  
rd to security export control, must be observed.

ly to show the main characteristics and application circuit examples  
l property right or other right owned by our company or any other  
any as to the infringement upon any such right owned by any other  
rmation described in this book.

standard applications or general electronic equipment (such as office  
and household appliances).

ng applications:

biles, traffic control equipment, combustion equipment, life support  
reliability are required, or if the failure or malfunction of the prod-

ck are subject to change without notice for modification and/or im-  
use of the products, therefore, ask for the most up-to-date Product  
atisfy your requirements.

bsolute maximum rating and the guaranteed operating conditions  
(.). Especially, please be careful not to exceed the range of absolute  
er-off and mode-switching. Otherwise, we will not be liable for any

take into the consideration of incidence of break down and failure  
n the systems such as redundant design, arresting the spread of fire  
al injury, fire, social damages, for example, by using the products.

own and characteristics change due to external factors (ESD, EOS,  
mounting or at customer's process. When using products for which  
shelf life and the elapsed time since first opening the packages.

ly or partially, without the prior written permission of Matsushita

## Looking for pricing, stock, or lifecycle information?

Click below to explore more details on WIN SOURCE:

 [View 2SK066400L on WIN SOURCE](#)

 [Panasonic Information](#)

## Optimize Your Supply Chain with WIN SOURCE Solutions

-  Global Sourcing Solution
-  Obsolete Management
-  Cost Control Management
-  Shortage Management
-  Alternative Solution
-  Excess Inventory Management