

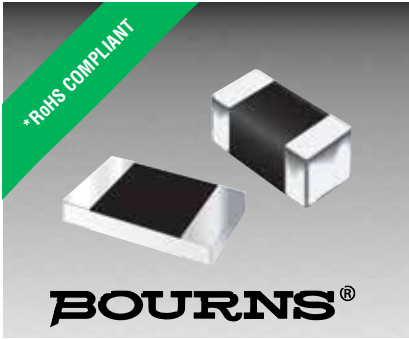

**THE DATASHEET OF
CG0402MLA-5.5MG**





Features

- 0402 and 0603 package options
- Rated for IEC 61000-4-2, level 4
- Withstands multiple ESD strikes
- Low capacitance and leakage currents for invisible load protection
- Tape and reel packaging
- Lead free

ChipGuard® MLA Series Varistor ESD Clamp Protectors

Description

The ChipGuard® CG0402MLA and CG0603MLA Series are based on a multilayer metal oxide technology. The MLA family is designed to protect sensitive electronic circuits from the threat of electrostatic discharge ESD. The MLA series is available from 5.5 V to 26 V DC working voltages.

The wide operating voltage and temperature range makes this family ideally suited to IC power supplies, signal and control line protection.

Electrical Characteristics @ 25 °C (unless otherwise noted)

Model	Vrms (V)	VDC (V)	VN Min. (V)	VN Max. (V)	VC (V)	ITM (Max.) (A)	WTM (Max.) (J)	CP (pF) Typ.
	<50 μ A		1 mA DC		1 A @ 8/20 μ s	@ 8/20 μ s	10/1000 μ s	@ 1 MHz
CG0402MLA-5.5MG	4	5.5	8.0	18.0	24	20	0.05	270
CG0402MLA-14LG	11	14	15.3	20.7	30	20	0.05	100
CG0402MLA-18KG	14	18	23.0	33.0	45	20	0.05	85
CG0603MLA-5.5ME	4	5.5	8.0	18.0	24	30	0.1	270
CG0603MLA-18KE	14	18	23.0	33.0	54	30	0.1	130
CG0603MLA-26KE	20	26	32.0	42.0	70	30	0.1	100

Environmental Characteristics

Operating Temperature.....-55 °C to +125 °C
 Storage Temperature.....-55 °C to +125 °C
 Response Time.....<1 ns
 Standard.....IEC 61000-4-2 Level 4

These products are RoHS compliant. There is some lead contained within the glass of the ceramic. This is acceptable under exemption no. 5 of the RoHS directive (DIRECTIVE 2002/95/EC OF THE EUROPEAN PARLIAMENT AND OF THE COUNCIL of 27 January 2003 on the restriction of the use of certain hazardous substances in electrical and electronic equipment).

Device Symbol

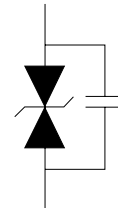

How to Order

CG 0n0n MLA - n.n x x

ChipGuard®
 Product Designator

Package Option
 0402 = 0402 Package
 0603 = 0603 Package

Multilayer Series Designator

Operating Voltage**
 5.5 = 5.5 V
 14 = 14 V
 18 = 18 V
 26 = 26 V

Tolerance
 K = 10 %
 L = 15 %
 M = 20 %

Tape & Reel Packaging
 E = 4,000 pcs. per reel (CG0603MLA Series)
 G = 10,000 pcs. per reel (CG0402MLA Series)

Ni barrier terminations are standard on all ChipGuard® part numbers.

** Only models lower than 10 volts require decimal point.

BOURNS®

Asia-Pacific: Tel: +886-2 2562-4117 • Email: asiacus@bourns.com

EMEA: Tel: +36 88 520 390 • Email: eurocus@bourns.com

The Americas: Tel: +1-951 781-5500 • Email: americus@bourns.com

www.bourns.com

*RoHS Directive 2002/95/EC Jan. 27, 2003 including annex and RoHS Recast 2011/65/EU June 8, 2011.

Specifications are subject to change without notice.

The device characteristics and parameters in this data sheet can and do vary in different applications and actual device performance may vary over time.

Users should verify actual device performance in their specific applications.

Voltage-Current Characteristics

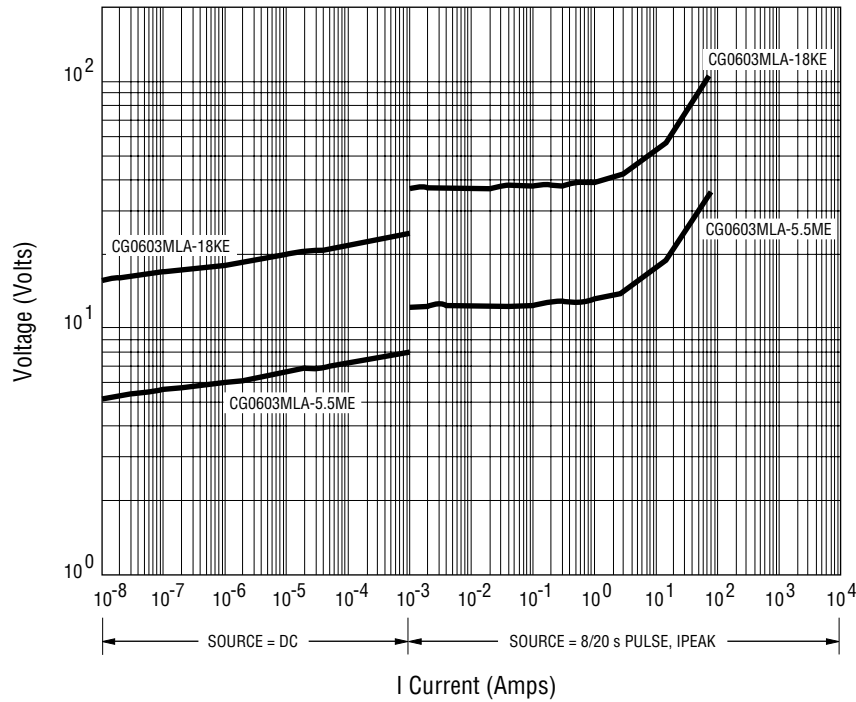
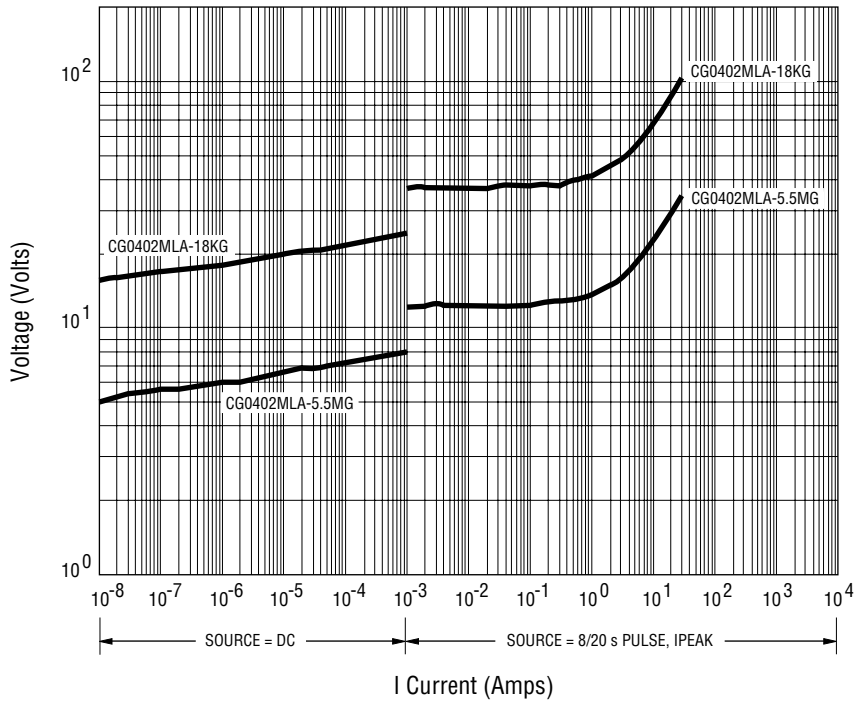

Specifications are subject to change without notice. The device characteristics and parameters in this data sheet can and do vary in different applications and actual device performance may vary over time. Users should verify actual device performance in their specific applications.

ChipGuard® MLA Series Varistor ESD Clamp Protectors

BOURNS®

Product Dimensions

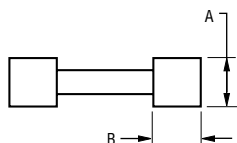
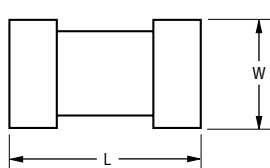

DIMENSIONS: $\frac{\text{MM}}{\text{(INCHES)}}$

Recommended Pad Layout

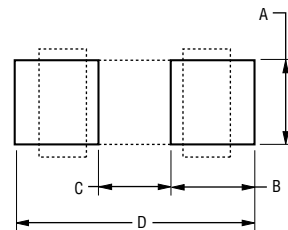

Dimension	CG0402MLA Series	CG0603MLA Series
L	$\frac{1.00 \pm 0.15}{(0.04 \pm 0.006)}$	$\frac{1.60 \pm 0.20}{(0.064 \pm 0.008)}$
W	$\frac{0.50 \pm 0.10}{(0.02 \pm 0.004)}$	$\frac{0.80 \pm 0.20}{(0.032 \pm 0.008)}$
A	$\frac{0.50 \pm 0.10}{(0.02 \pm 0.004)}$	$\frac{0.80 \pm 0.20}{(0.032 \pm 0.008)}$
B	$\frac{0.25 \pm 0.15}{(0.10 \pm 0.006)}$	$\frac{0.30 \pm 0.20}{(0.012 \pm 0.008)}$

Dim.	CG0402MLA Series	CG0603MLA Series
A	$\frac{0.51}{(0.020)}$	$\frac{0.76}{(0.030)}$
B	$\frac{0.61}{(0.024)}$	$\frac{1.02}{(0.040)}$
C	$\frac{0.51}{(0.020)}$	$\frac{0.50}{(0.020)}$
D	$\frac{1.70}{(0.067)}$	$\frac{2.54}{(0.100)}$

Solder Reflow Recommendations

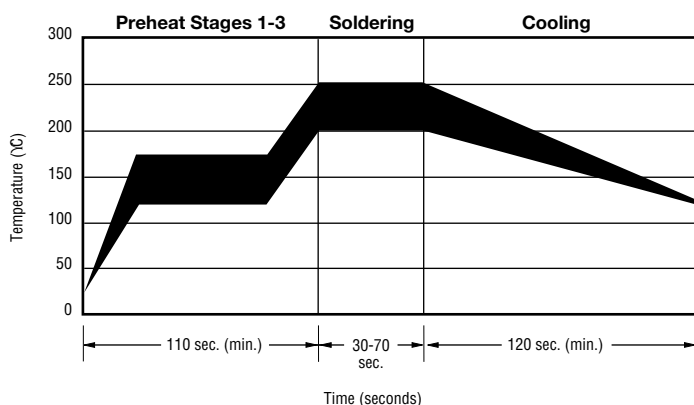

A	Stage 1 Preheat	Ambient to Preheating Temperature	30 s to 60 s
B	Stage 2 Preheat	140 °C to 160 °C	60 s to 120 s
C	Stage 3 Preheat	Preheat to 200 °C	20 s to 40 s
D	Main Heating	200 °C 210 °C 220 °C 230 °C 240 °C	60 s to 70 s 55 s to 65 s 50 s to 60 s 40 s to 50 s 30 s to 40 s
E	Cooling	200 °C to 100 °C	1 °C/s to 4 °C/s

- This product can be damaged by rapid heating, cooling or localized heating.
- Heat shocks should be avoided. Preheating and gradual cooling recommended.
- Excessive solder can damage the device. Print solder thickness of 150 to 200 um recommended.
- Solder gun tip temperature should be kept below 280 °C and should not touch the device directly. Contact should be less than 3 seconds. A solder gun under 30 watts is recommended.

Specifications are subject to change without notice.

The device characteristics and parameters in this data sheet can and do vary in different applications and actual device performance may vary over time. Users should verify actual device performance in their specific applications.

ChipGuard® MLA Series Varistor ESD Clamp Protectors

BOURNS®

Packaging Dimensions

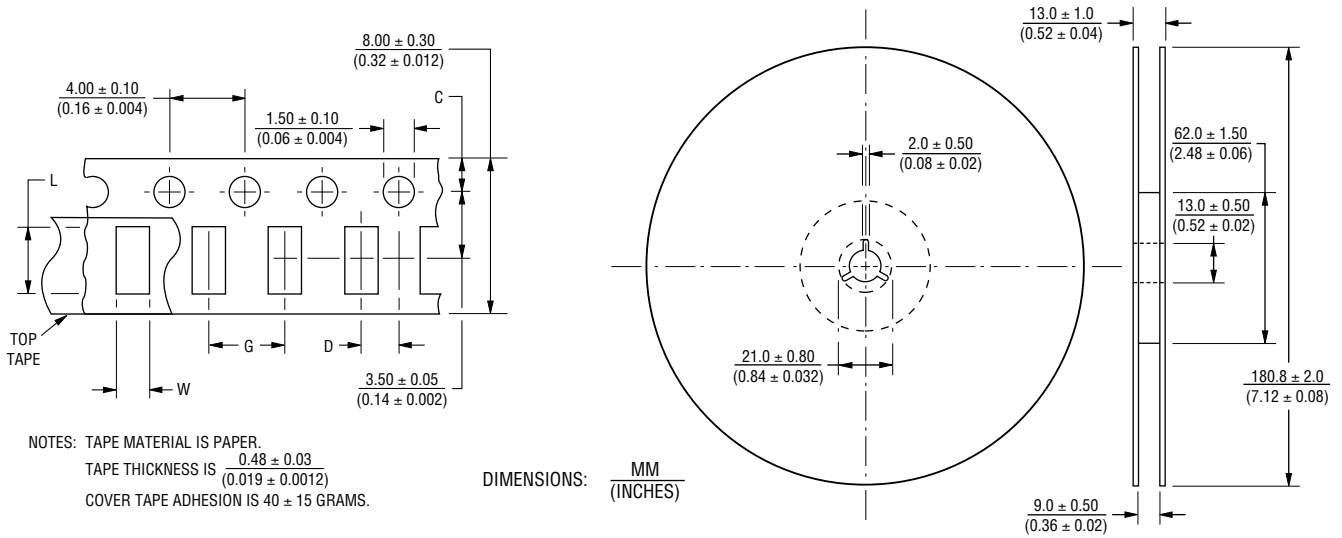

Dimension	CG0402MLA Series	CG0603MLA Series
C	$\frac{1.75 \pm 0.05}{(0.04 \pm 0.002)}$	$\frac{1.75 \pm 0.10}{(0.04 \pm 0.004)}$
D	$\frac{2.00 \pm 0.02}{(0.08 \pm 0.0008)}$	$\frac{2.00 \pm 0.05}{(0.08 \pm 0.002)}$
L	$\frac{1.19 \pm 0.05}{(0.047 \pm 0.002)}$	$\frac{1.80 \pm 0.20}{(0.072 \pm 0.008)}$
W	$\frac{0.69 \pm 0.05}{(0.027 \pm 0.002)}$	$\frac{0.90 \pm 0.20}{(0.036 \pm 0.008)}$
G	$\frac{2.0 \pm 0.05}{(0.08 \pm 0.002)}$	$\frac{4.0 \pm 0.05}{(0.16 \pm 0.002)}$

REV. 0 08/16

Specifications are subject to change without notice.
 The device characteristics and parameters in this data sheet can and do vary in different applications and actual device performance may vary over time.
 Users should verify actual device performance in their specific applications.

Looking for pricing, stock, or lifecycle information?

Click below to explore more details on WIN SOURCE:

- ⊖ [View CG0402MLA-5.5MG on WIN SOURCE](#)
- ⊖ [Bourns Inc. Information](#)

Optimize Your Supply Chain with WIN SOURCE Solutions

- ✓ Global Sourcing Solution
- ✓ Obsolete Management
- ✓ Cost Control Management
- ✓ Shortage Management
- ✓ Alternative Solution
- ✓ Excess Inventory Management