

**Depletion Mode
MOSFET**

**IXTT16N20D2
IXTH16N20D2**

$V_{DSX} = 200V$
 $I_{D(on)} \geq 16A$
 $R_{DS(on)} \leq 80m\Omega$

N-Channel

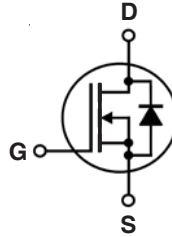

TO-268 (IXTT)

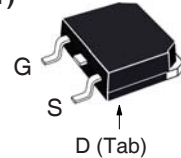

TO-247 (IXTH)

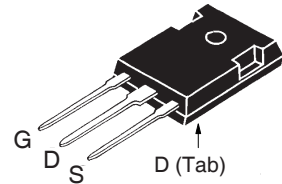

G = Gate D = Drain
 S = Source Tab = Drain

Symbol	Test Conditions	Maximum Ratings	
V_{DSX}	$T_J = 25^\circ C$ to $150^\circ C$	200	V
V_{DGX}	$T_J = 25^\circ C$ to $150^\circ C$, $R_{GS} = 1M\Omega$	200	V
V_{GSX}	Continuous	± 20	V
V_{GSM}	Transient	± 30	V
P_D	$T_C = 25^\circ C$	695	W
T_J		- 55 ... +150	$^\circ C$
T_{JM}		150	$^\circ C$
T_{stg}		- 55 ... +150	$^\circ C$
T_L	Maximum Lead Temperature for Soldering	300	$^\circ C$
T_{SOLD}	1.6 mm (0.062in.) from Case for 10s	260	$^\circ C$
M_d	Mounting Torque (TO-247)	1.13 / 10	Nm/lb.in.
Weight	TO-268	4	g
	TO-247	6	g

Symbol	Test Conditions ($T_J = 25^\circ C$, Unless Otherwise Specified)	Characteristic Values		
		Min.	Typ.	Max.
BV_{DSX}	$V_{GS} = -5V$, $I_D = 250\mu A$	200		V
$V_{GS(off)}$	$V_{DS} = 25V$, $I_D = 4mA$	- 2.0		- 4.5 V
I_{GSX}	$V_{GS} = \pm 20V$, $V_{DS} = 0V$			± 100 nA
$I_{DSX(off)}$	$V_{DS} = V_{DSX}$, $V_{GS} = -5V$ $T_J = 125^\circ C$			5 μA 100 μA
$R_{DS(on)}$	$V_{GS} = 0V$, $I_D = 8A$, Note 1			80 m Ω
$I_{D(on)}$	$V_{GS} = 0V$, $V_{DS} = 25V$, Note 1	16		A

Features

- Normally ON Mode
- International Standard Packages
- Molding Epoxies Meet UL 94 V-0 Flammability Classification

Advantages

- Easy to Mount
- Space Savings
- High Power Density

Applications

- Audio Amplifiers
- Start-up Circuits
- Protection Circuits
- Ramp Generators
- Current Regulators
- Active Loads

Symbol	Test Conditions ($T_J = 25^\circ\text{C}$, Unless Otherwise Specified)	Characteristic Values		
		Min.	Typ.	Max.
g_{fs}	$V_{DS} = 20\text{V}, I_D = 8\text{A}$, Note 1	7	12	S
C_{iss}	$V_{GS} = -10\text{V}, V_{DS} = 25\text{V}, f = 1\text{MHz}$		5500	pF
C_{oss}			1360	pF
C_{rss}			607	pF
$t_{d(on)}$	Resistive Switching Times $V_{GS} = \pm 5\text{V}, V_{DS} = 100\text{V}, I_D = 8\text{A}$ $R_G = 3.3\Omega$ (External)		46	ns
t_r			130	ns
$t_{d(off)}$			270	ns
t_f			135	ns
$Q_{g(on)}$	$V_{GS} = \pm 5\text{V}, V_{DS} = 100\text{V}, I_D = 8\text{A}$		208	nC
Q_{gs}			28	nC
Q_{gd}			110	nC
R_{thJC}	TO-247			0.18 $^\circ\text{C/W}$
R_{thCS}			0.21	$^\circ\text{C/W}$

Safe-Operating-Area Specification

Symbol	Test Conditions	Characteristic Values		
		Min.	Typ.	Max.
SOA	$V_{DS} = 200\text{V}, I_D = 2.1\text{A}, T_C = 75^\circ\text{C}, t_p = 5\text{s}$	420		W

Source-Drain Diode

Symbol	Test Conditions ($T_J = 25^\circ\text{C}$, Unless Otherwise Specified)	Characteristic Values		
		Min.	Typ.	Max.
V_{SD}	$I_F = 16\text{A}, V_{GS} = -10\text{V}$, Note 1		0.8	1.3 V
t_{rr}	$I_F = 8\text{A}, -di/dt = 100\text{A}/\mu\text{s}$ $V_R = 100\text{V}, V_{GS} = -10\text{V}$		265	ns
I_{RM}			14.3	A
Q_{RM}			1.9	μC

Note 1. Pulse test, $t \leq 300\mu\text{s}$, duty cycle, $d \leq 2\%$.

TO-247 Outline

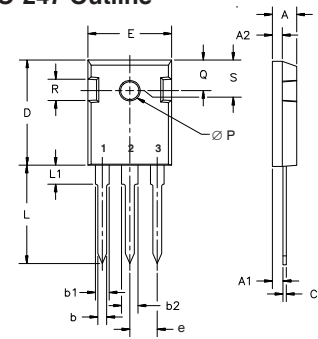

Terminals: 1 - Gate
2 - Drain
3 - Source

Dim.	Millimeter		Inches	
	Min.	Max.	Min.	Max.
A	4.7	5.3	.185	.209
A ₁	2.2	2.54	.087	.102
A ₂	2.2	2.6	.059	.098
b	1.0	1.4	.040	.055
b ₁	1.65	2.13	.065	.084
b ₂	2.87	3.12	.113	.123
C	.4	.8	.016	.031
D	20.80	21.46	.819	.845
E	15.75	16.26	.610	.640
e	5.20	5.72	0.205	0.225
L	19.81	20.32	.780	.800
L ₁		4.50		.177
∅P	3.55	3.65	.140	.144
Q	5.89	6.40	0.232	0.252
R	4.32	5.49	.170	.216
S	6.15	BSC	.242	BSC

TO-268 Outline

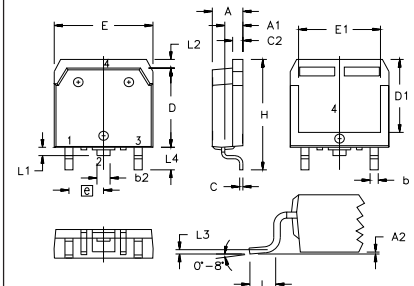

Terminals: 1 - Gate
2 - Drain
3 - Source
4 - Drain

SYM	INCHES		MILLIMETERS	
	MIN	MAX	MIN	MAX
A	.193	.201	4.90	5.10
A ₁	.106	.114	2.70	2.90
A ₂	.001	.010	0.02	0.25
b	.045	.057	1.15	1.45
b ₂	.075	.083	1.90	2.10
C	.016	.026	0.40	0.65
C ₂	.057	.063	1.45	1.60
D	.543	.551	13.80	14.00
D ₁	.488	.500	12.40	12.70
E	.624	.632	15.85	16.05
E ₁	.524	.535	13.30	13.60
e	.215 BSC		5.45 BSC	
H	.736	.752	18.70	19.10
L	.094	.106	2.40	2.70
L ₁	.047	.055	1.20	1.40
L ₂	.039	.045	1.00	1.15
L ₃	.010 BSC		0.25 BSC	
L ₄	.150	.161	3.80	4.10

IXYS Reserves the Right to Change Limits, Test Conditions, and Dimensions.

IXYS MOSFETs and IGBTs are covered by one or more of the following U.S. patents:	4,835,592	4,931,844	5,049,961	5,237,481	6,162,665	6,404,065 B1	6,683,344	6,727,585	7,005,734 B2	7,157,338B2
	4,860,072	5,017,508	5,063,307	5,381,025	6,259,123 B1	6,534,343	6,710,405 B2	6,759,692	7,063,975 B2	
	4,881,106	5,034,796	5,187,117	5,486,715	6,306,728 B1	6,583,505	6,710,463	6,771,478 B2	7,071,537	

Fig. 1. Output Characteristics @ $T_J = 25^\circ\text{C}$

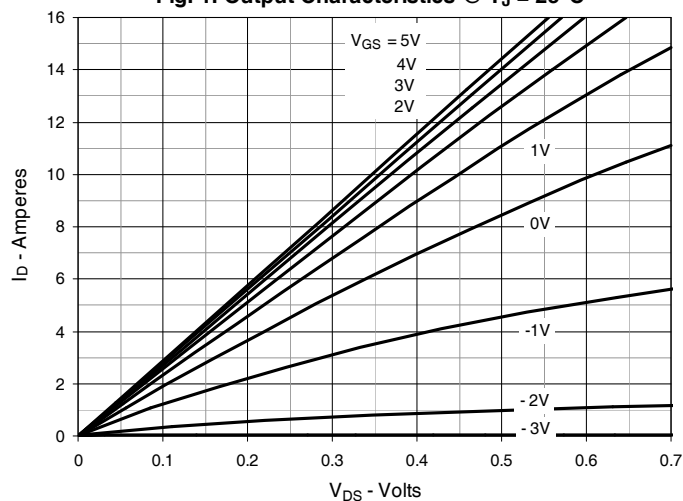

Fig. 2. Extended Output Characteristics @ $T_J = 25^\circ\text{C}$

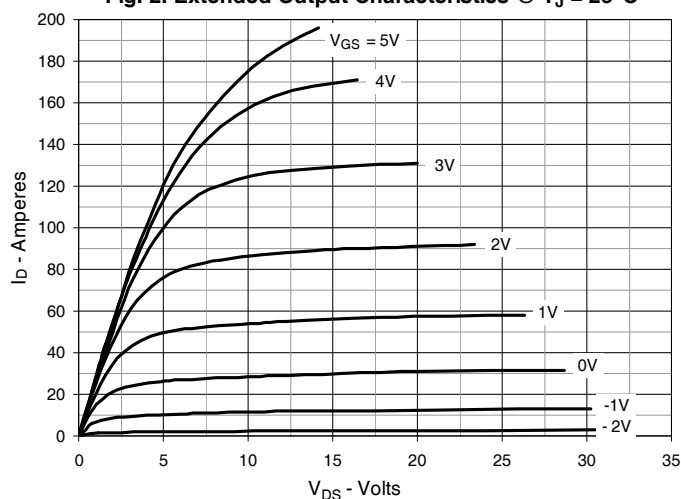

Fig. 3. Output Characteristics @ $T_J = 125^\circ\text{C}$

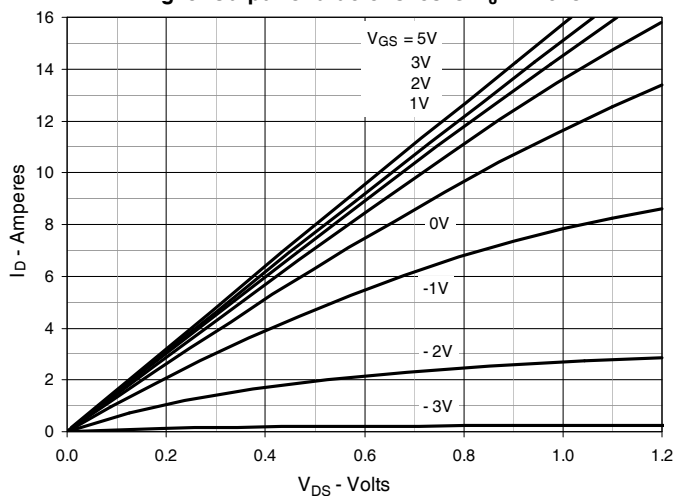

Fig. 4. Drain Current @ $T_J = 25^\circ\text{C}$

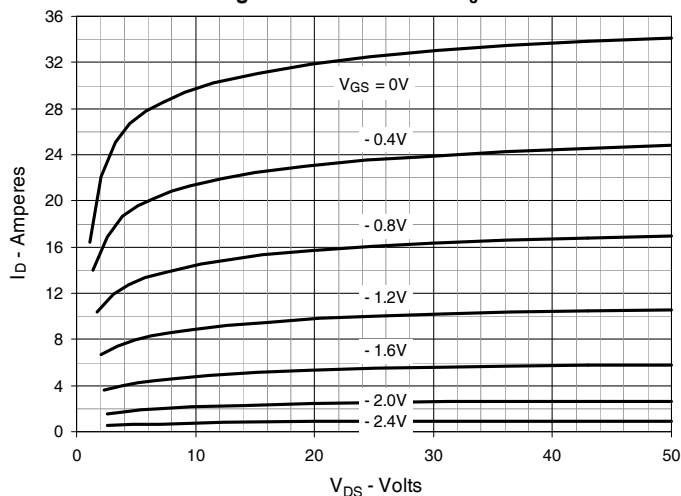

Fig. 5. Drain Current @ $T_J = 100^\circ\text{C}$

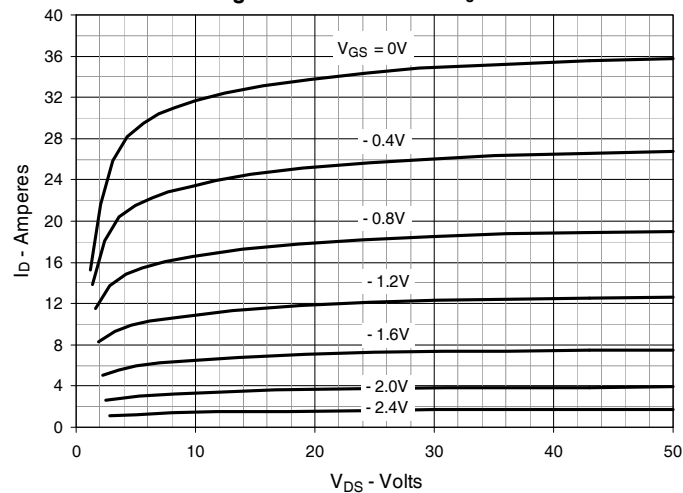

Fig. 6. Dynamic Resistance vs. Gate Voltage

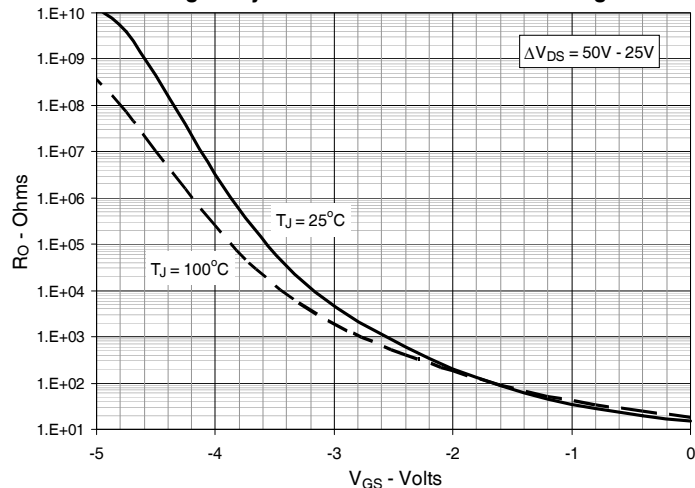

Fig. 7. Normalized $R_{DS(on)}$ vs. Junction Temperature

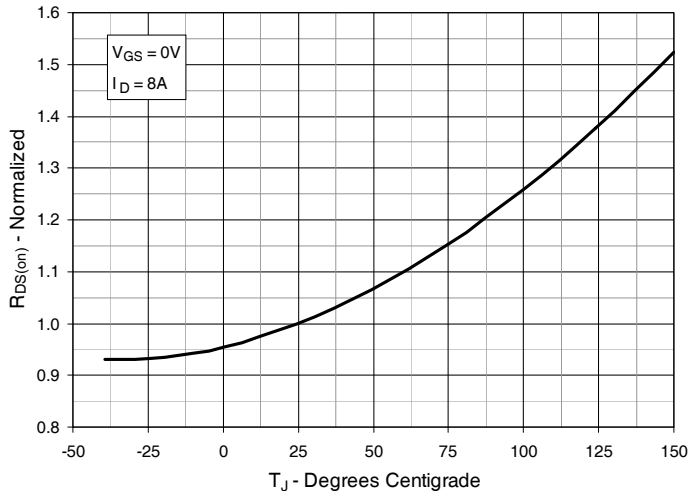

Fig. 8. $R_{DS(on)}$ Normalized to $I_D = 8A$ Value vs. Drain Current

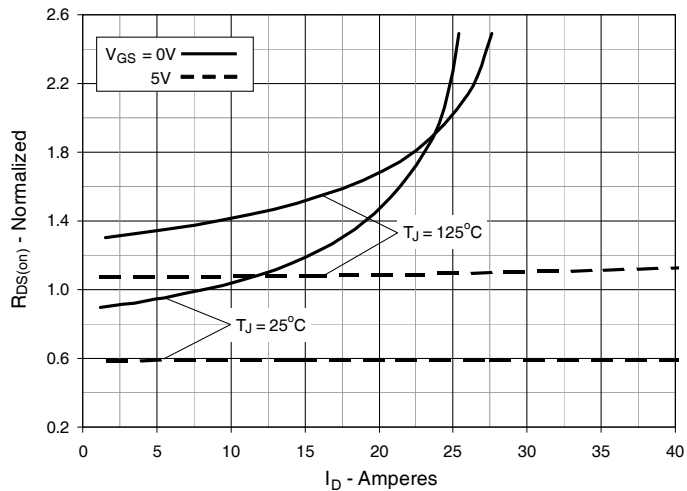

Fig. 9. Input Admittance

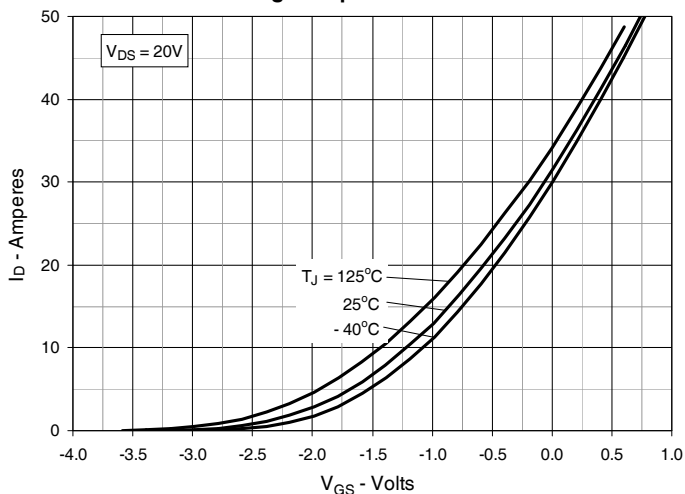

Fig. 10. Transconductance

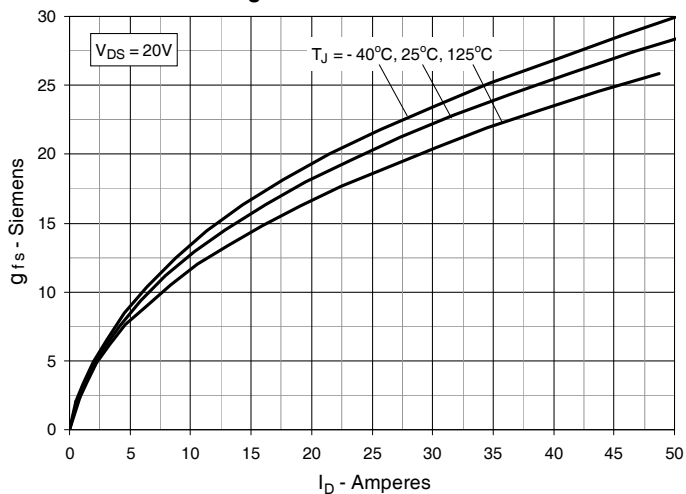

Fig. 11. Normalized Breakdown and Threshold Voltages vs. Junction Temperature

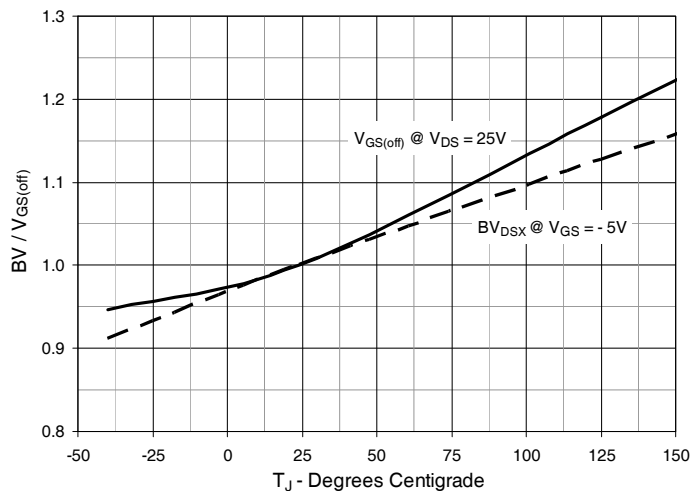

Fig. 12. Forward Voltage Drop of Intrinsic Diode

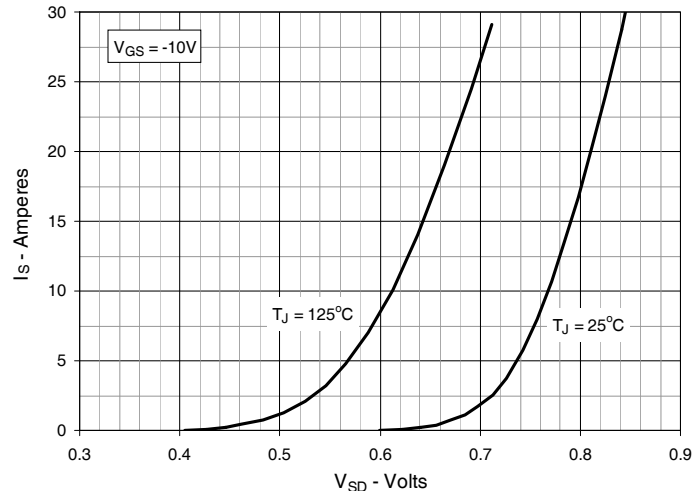

Fig. 13. Capacitance

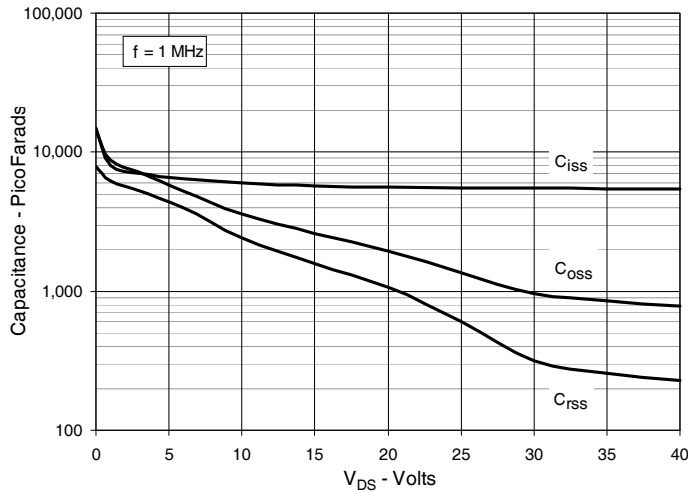
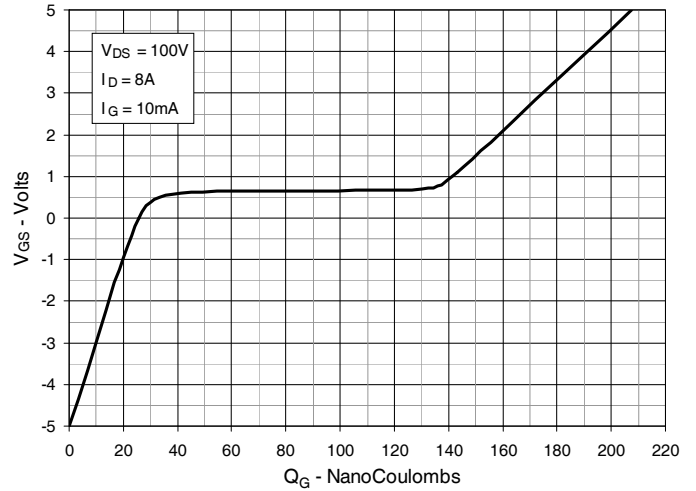
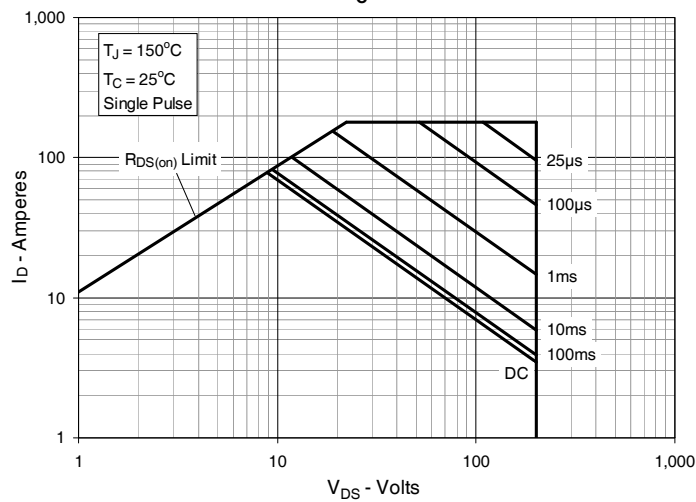

Fig. 14. Gate Charge



**Fig. 15. Forward-Bias Safe Operating Area
@ T_C = 25°C**



**Fig. 16. Forward-Bias Safe Operating Area
@ T_C = 75°C**

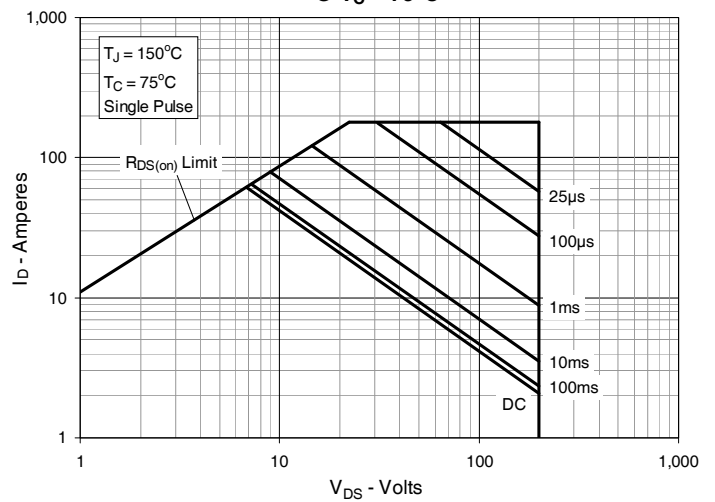
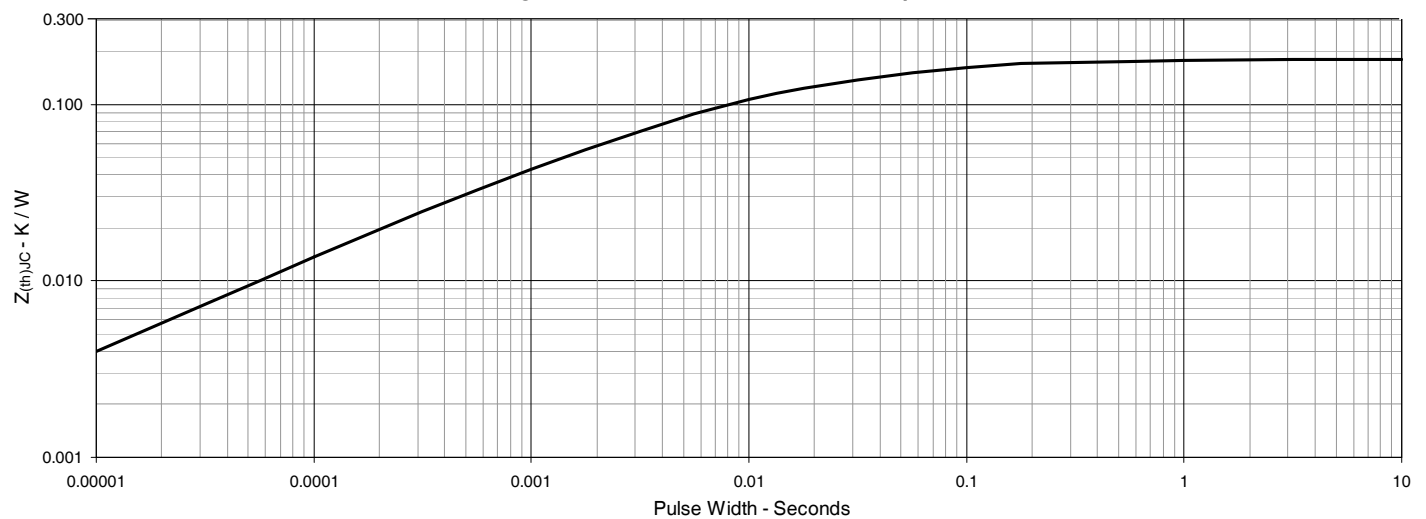

Fig. 17. Maximum Transient Thermal Impedance





Disclaimer Notice - Information furnished is believed to be accurate and reliable. However, users should independently evaluate the suitability of and test each product selected for their own applications. Littelfuse products are not designed for, and may not be used in, all applications. Read complete Disclaimer Notice at www.littelfuse.com/disclaimer-electronics.

Looking for pricing, stock, or lifecycle information?

Click below to explore more details on WIN SOURCE:

 [View IXTH16N20D2 on WIN SOURCE](#)

 [IXYS Information](#)

Optimize Your Supply Chain with WIN SOURCE Solutions

-  Global Sourcing Solution
-  Obsolete Management
-  Cost Control Management
-  Shortage Management
-  Alternative Solution
-  Excess Inventory Management