

UNR921xG Series

Silicon NPN epitaxial planar type

For digital circuits

■ Features

- Costs can be reduced through downsizing of the equipment and reduction of the number of parts.
- SS-Mini type package, allowing automatic insertion through tape packing.

■ Resistance by Part Number

	Marking Symbol	(R ₁)	(R ₂)
• UNR9210G	8L	47 kΩ	—
• UNR9211G	8A	10 kΩ	10 kΩ
• UNR9212G	8B	22 kΩ	22 kΩ
• UNR9213G	8C	47 kΩ	47 kΩ
• UNR9214G	8D	10 kΩ	47 kΩ
• UNR9215G	8E	10 kΩ	—
• UNR9216G	8F	4.7 kΩ	—
• UNR9217G	8H	22 kΩ	—
• UNR9218G	8I	0.51 kΩ	5.1 kΩ
• UNR9219G	8K	1 kΩ	10 kΩ
• UNR921AG	8X	100 kΩ	100 kΩ
• UNR921BG	8Y	100 kΩ	—
• UNR921CG	8Z	—	47 kΩ
• UNR921DG	8M	47 kΩ	10 kΩ
• UNR921EG	8N	47 kΩ	22 kΩ
• UNR921FG	8O	4.7 kΩ	10 kΩ
• UNR921KG	8P	10 kΩ	4.7 kΩ
• UNR921LG	8Q	4.7 kΩ	4.7 kΩ
• UNR921MG	EL	2.2 kΩ	47 kΩ
• UNR921NG	EX	4.7 kΩ	47 kΩ
• UNR921TG	EZ	22 kΩ	47 kΩ
• UNR921VG	FD	2.2 kΩ	2.2 kΩ

■ Package

- Code
SSMini3-F3
- Pin Name
1: Base
2: Emitter
3: Collector

■ Internal Connection

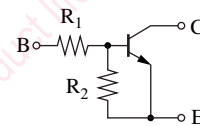

■ Absolute Maximum Ratings T_a = 25°C

Parameter	Symbol	Rating	Unit
Collector-base voltage (Emitter open)	V _{CBO}	50	V
Collector-emitter voltage (Base open)	V _{CEO}	50	V
Collector current	I _C	100	mA
Total power dissipation	P _T	125	mW
Junction temperature	T _j	125	°C
Storage temperature	T _{stg}	-55 to +125	°C

Electrical Characteristics $T_a = 25^\circ\text{C} \pm 3^\circ\text{C}$

Parameter		Symbol	Conditions	Min	Typ	Max	Unit
Collector-base voltage (Emitter open)		V_{CBO}	$I_C = 10 \mu\text{A}, I_E = 0$	50			V
Collector-emitter voltage (Base open)		V_{CEO}	$I_C = 2 \text{ mA}, I_B = 0$	50			V
Collector-base cut-off current (Emitter open)		I_{CBO}	$V_{CB} = 50 \text{ V}, I_E = 0$			0.1	μA
Collector-emitter cut-off current (Base open)		I_{CEO}	$V_{CE} = 50 \text{ V}, I_B = 0$			0.5	μA
Emitter-base cut-off current (Collector open)	UNR9210G/9215G/9216G/9217G/921BG	I_{EBO}	$V_{EB} = 6 \text{ V}, I_C = 0$			0.01	mA
	UNR9213G/921AG					0.1	
	UNR9212G/9214G/921DG/921EG/921MG/921NG/921TG					0.2	
	UNR9211G					0.5	
	UNR921FG/921KG					1.0	
	UNR9219G					1.5	
	UNR9218G/921CG/921LG/921VG					2.0	
Forward current transfer ratio	UNR921VG	h_{FE}	$V_{CE} = 10 \text{ V}, I_C = 5 \text{ mA}$	6		20	—
	UNR9218G/921KG/921LG			20			
	UNR9219G/921DG/921FG			30			
	UNR9211G			35			
	UNR9212G/921EG			60			
	UNR9213G/9214G/921AG/921CG/921MG			80			
	UNR921NG/921TG			80	400		
	UNR9210G/9215G/9216G/9217G/921BG			160	460		
Collector-emitter saturation voltage		$V_{CE(sat)}$	$I_C = 10 \text{ mA}, I_B = 0.3 \text{ mA}$			0.25	V
UNR921VG			$I_C = 10 \text{ mA}, I_B = 1.5 \text{ mA}$				
Output voltage high-level		V_{OH}	$V_{CC} = 5 \text{ V}, V_B = 0.5 \text{ V}, R_L = 1 \text{ k}\Omega$	4.9			V
Output voltage low-level		V_{OL}	$V_{CC} = 5 \text{ V}, V_B = 2.5 \text{ V}, R_L = 1 \text{ k}\Omega$			0.2	V
UNR9213G/921BG/921KG			$V_{CC} = 5 \text{ V}, V_B = 3.5 \text{ V}, R_L = 1 \text{ k}\Omega$				
UNR921DG			$V_{CC} = 5 \text{ V}, V_B = 10 \text{ V}, R_L = 1 \text{ k}\Omega$				
UNR921EG			$V_{CC} = 5 \text{ V}, V_B = 6 \text{ V}, R_L = 1 \text{ k}\Omega$				
UNR921AG			$V_{CC} = 5 \text{ V}, V_B = 5 \text{ V}, R_L = 1 \text{ k}\Omega$				
Transition frequency		f_T	$V_{CB} = 10 \text{ V}, I_E = -2 \text{ mA}, f = 200 \text{ MHz}$		150		MHz
Input resistance	UNR9218G	R_1		-30%	0.51	+30%	k Ω
	UNR9219G				1		
	UNR921MG/921VG				2.2		
	UNR9216G/921FG/921LG/921NG				4.7		
	UNR9211G/9214G/9215G/921KG				10		
	UNR9212G/9217G/921TG				22		
	UNR9210G/9213G/921DG/921EG				47		
	UNR921AG/921BG				100		

Note) Measuring methods are based on JAPANESE INDUSTRIAL STANDARD JIS C 7030 measuring methods for transistors.

■ Electrical Characteristics (continued) $T_a = 25^\circ\text{C} \pm 3^\circ\text{C}$

Parameter		Symbol	Conditions	Min	Typ	Max	Unit
Emitter-base resistance	UNR921CG	R_2		-30%	47	+30%	k Ω
Resistance ratio	UNR921MG	R_1/R_2			0.047		—
	UNR921NG				0.1		
	UNR9218G/9219G			0.08	0.10	0.12	
	UNR9214G			0.17	0.21	0.25	
	UNR921TG				0.47		
	UNR921FG			0.37	0.47	0.57	
	UNR921AG/921VG				1.0		
	UNR9211G/9212G/9213G/921LG			0.8	1.0	1.2	
	UNR921KG			1.70	2.13	2.60	
	UNR921EG			1.70	2.14	2.60	
UNR921DG		3.7	4.7	5.7			

Note) Measuring methods are based on JAPANESE INDUSTRIAL STANDARD JIS C 7030 measuring methods for transistors.

Common characteristics chart

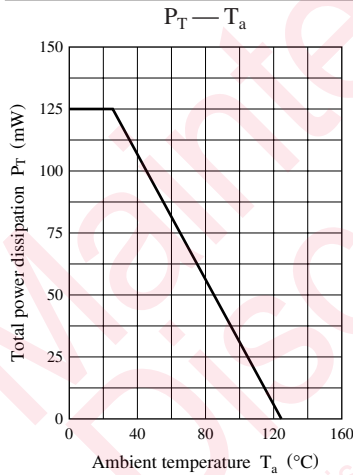

Characteristics charts of UNR9210G

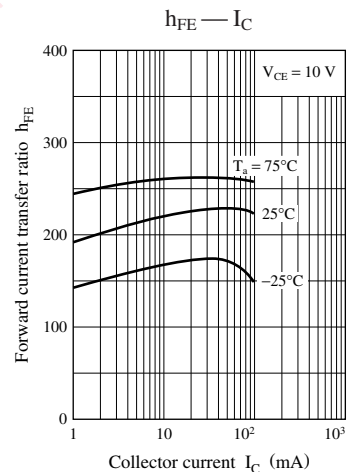
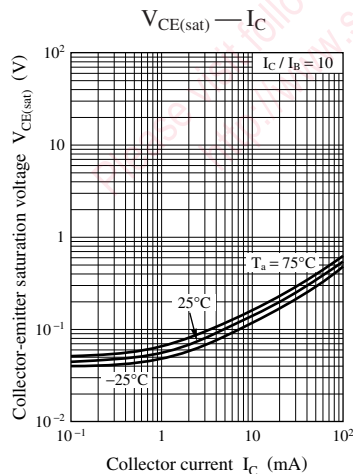
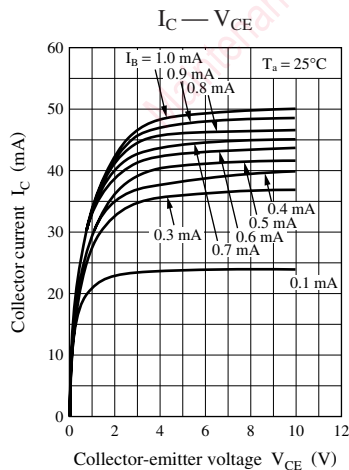

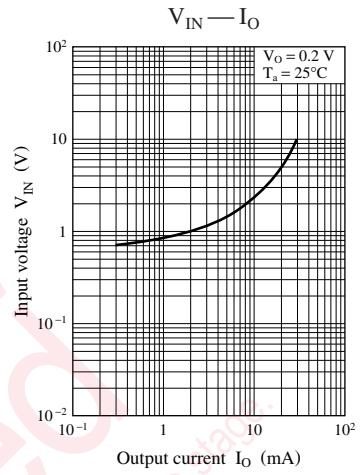
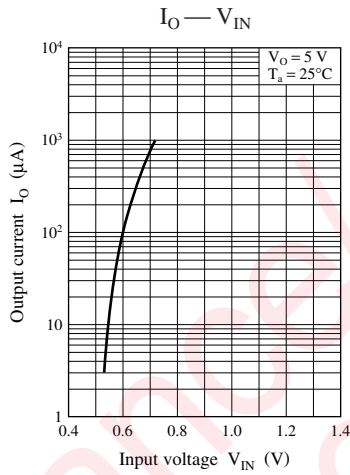
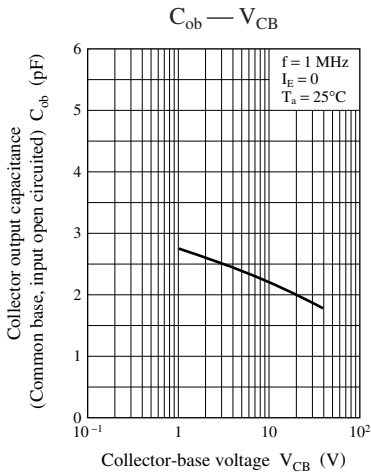

Characteristics charts of UNR9211G

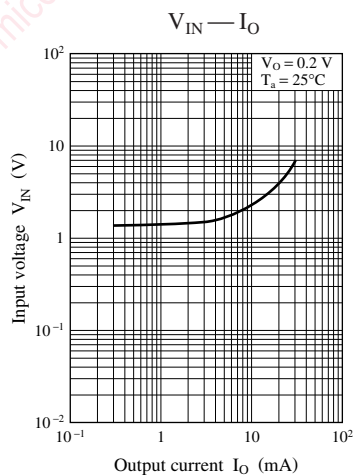
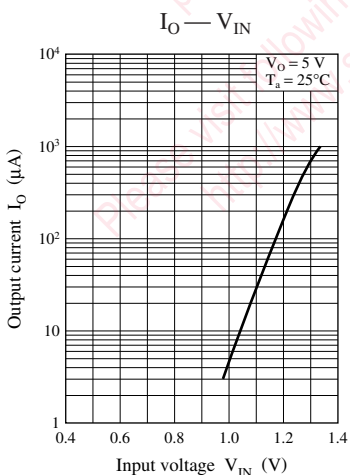
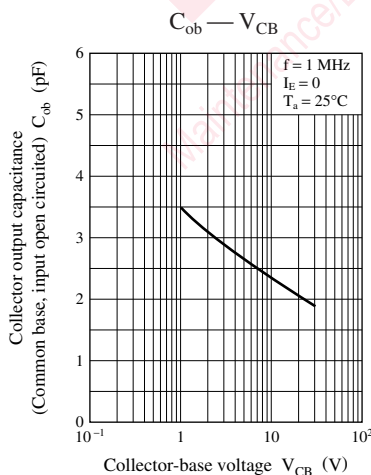
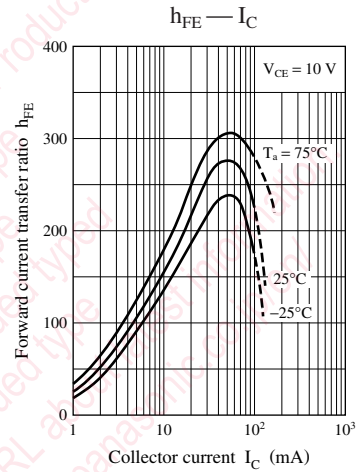
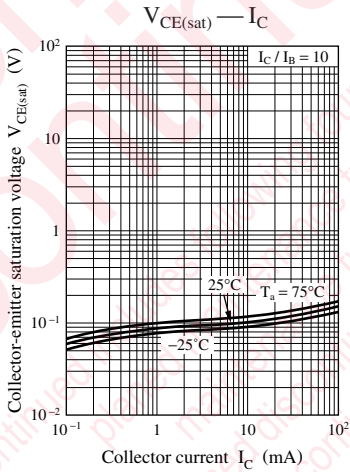
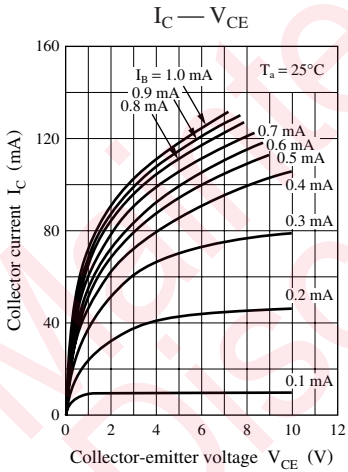

Characteristics charts of UNR9212G

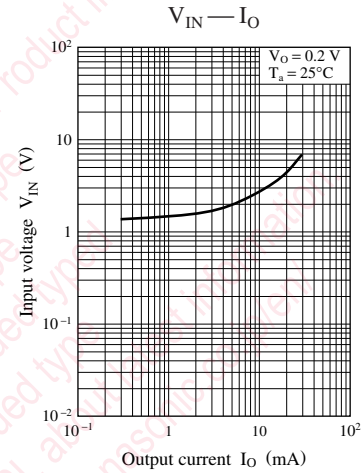
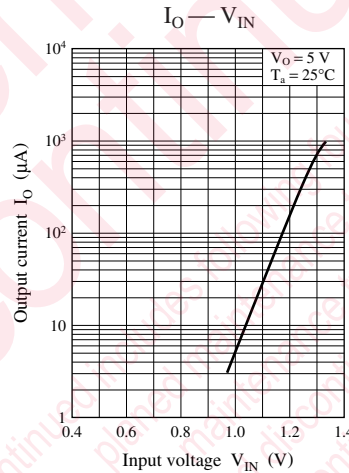
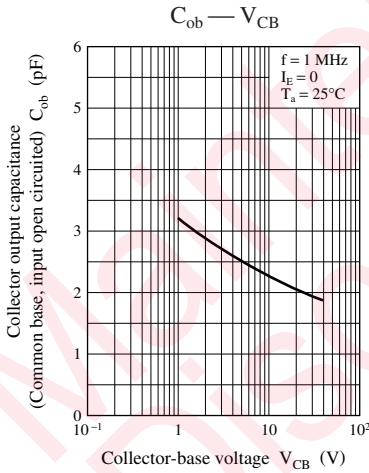
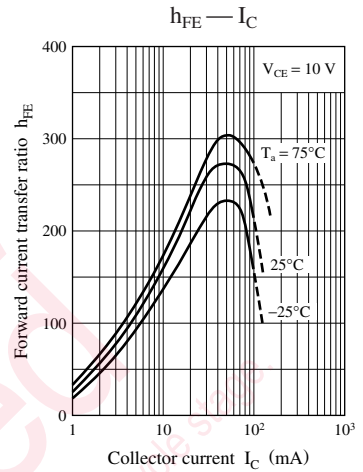
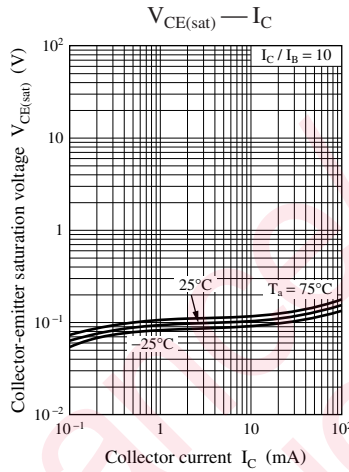
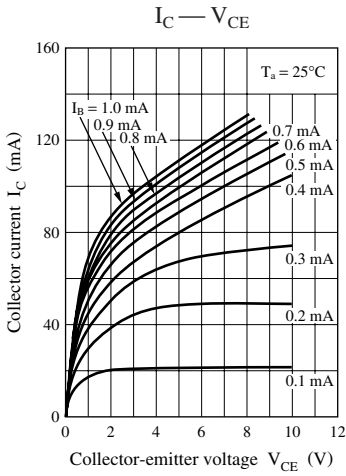

Characteristics charts of UNR9213G

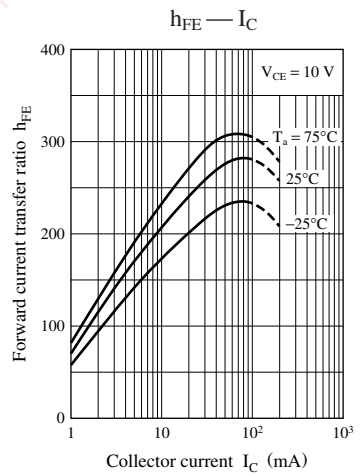
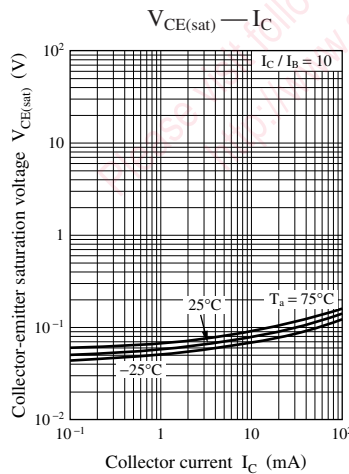
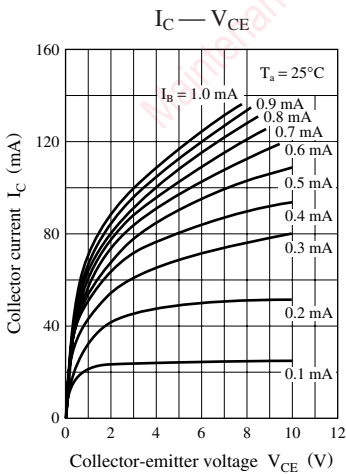

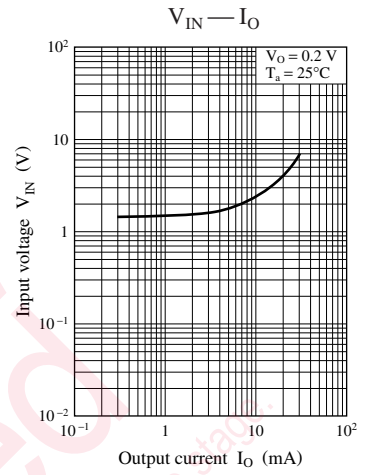
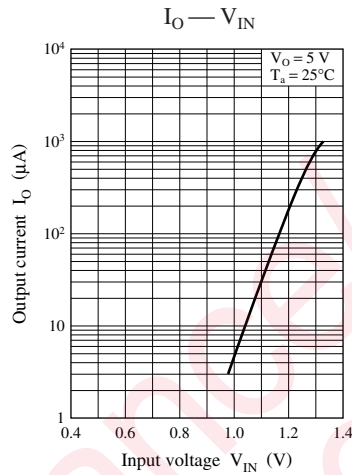
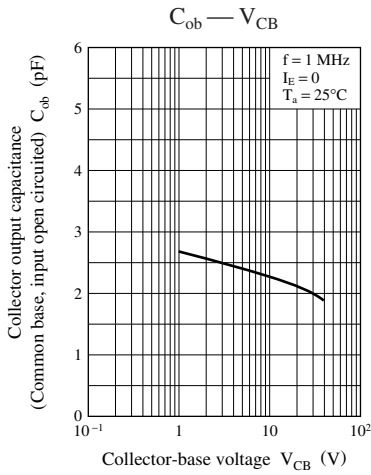

Characteristics charts of UNR9214G

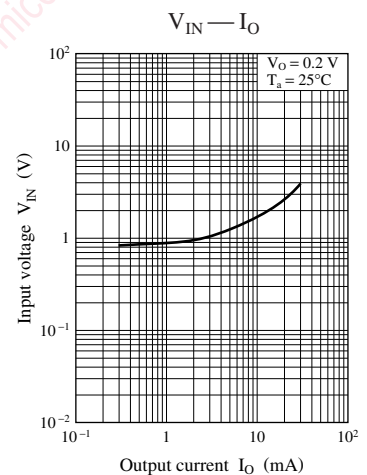
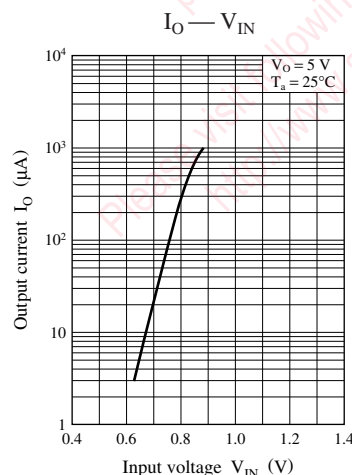
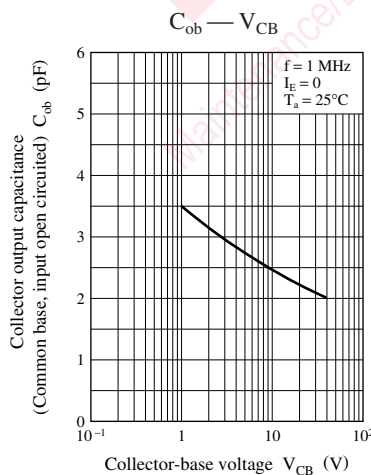
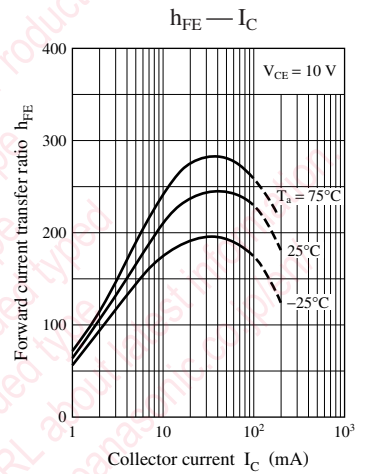
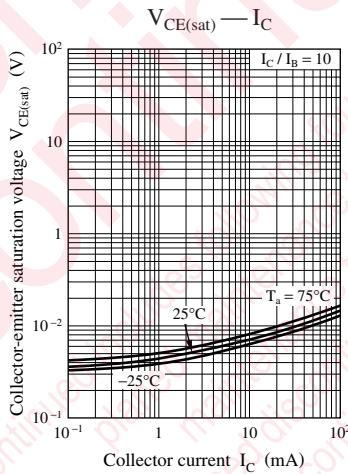
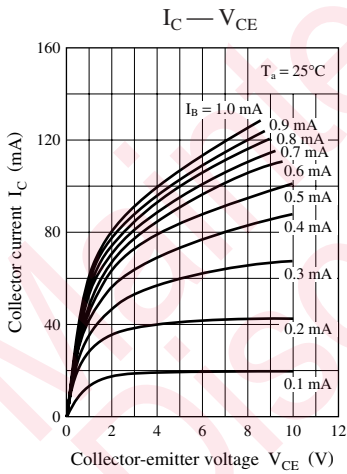

Characteristics charts of UNR9215G

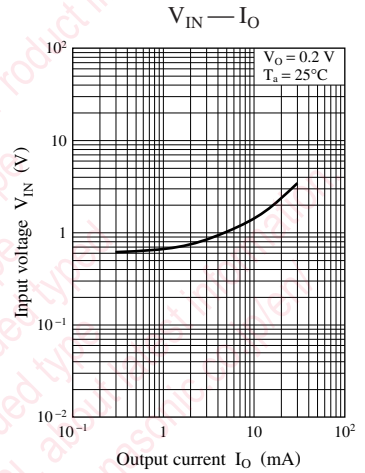
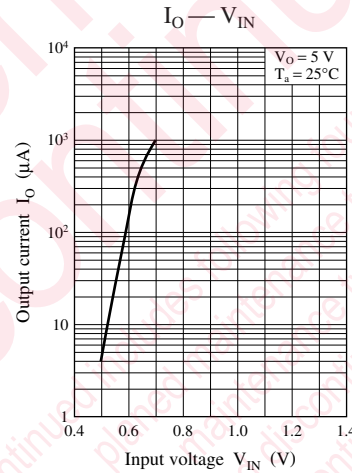
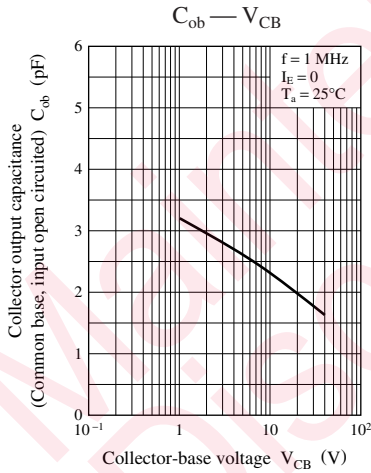
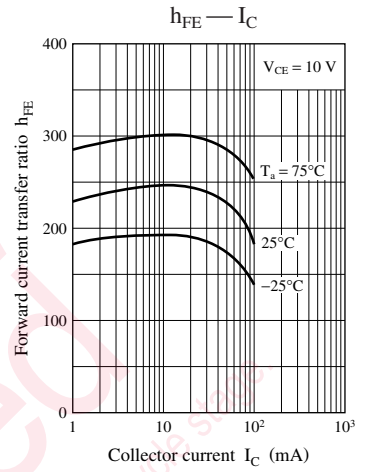
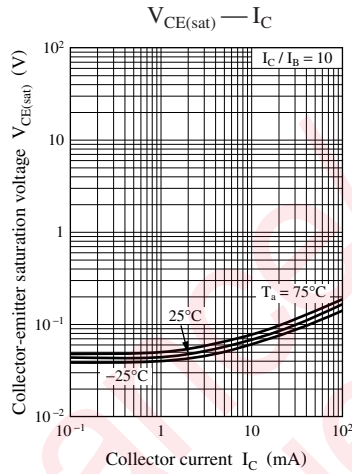
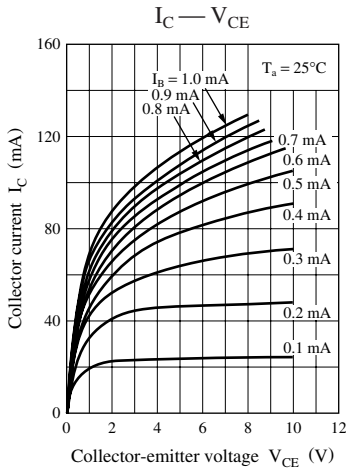

Characteristics charts of UNR9216G

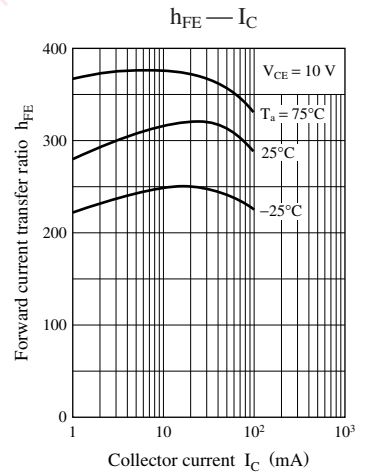
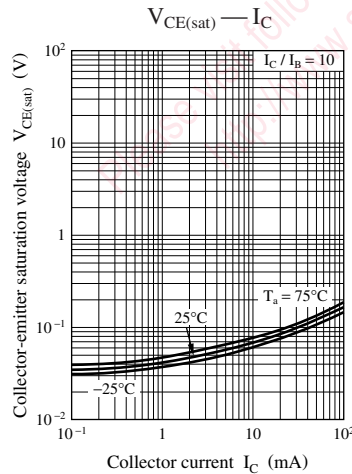
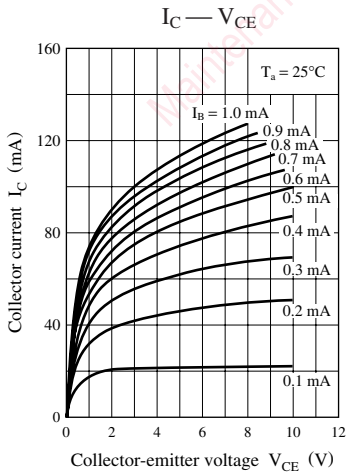

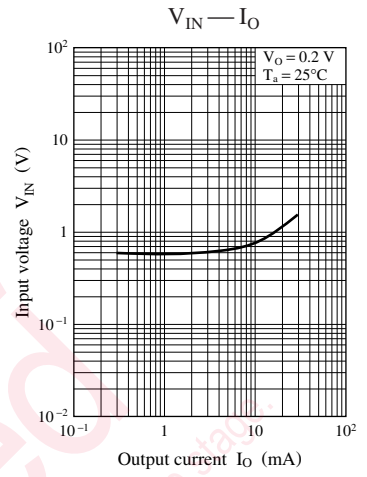
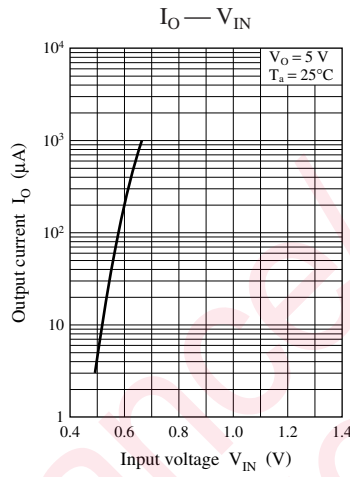
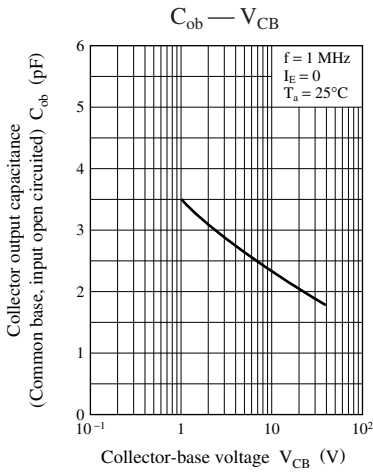

Characteristics charts of UNR9217G

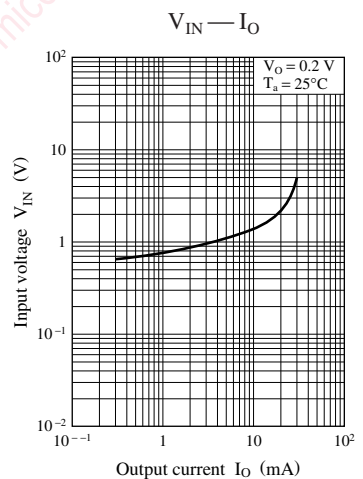
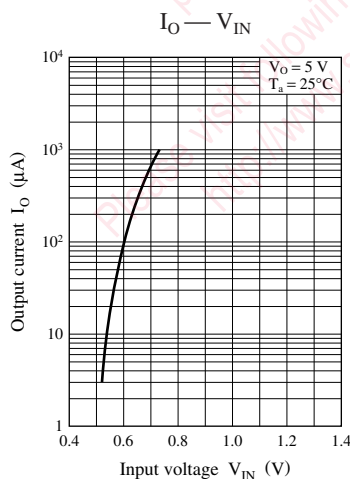
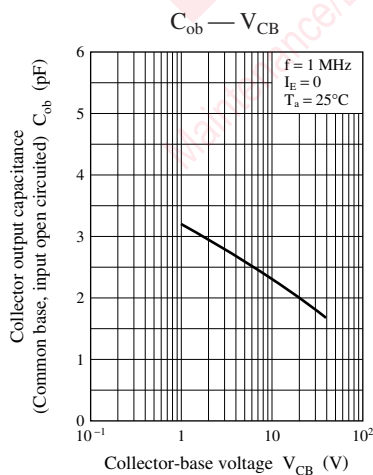
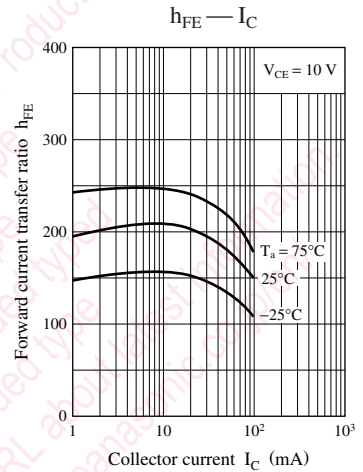
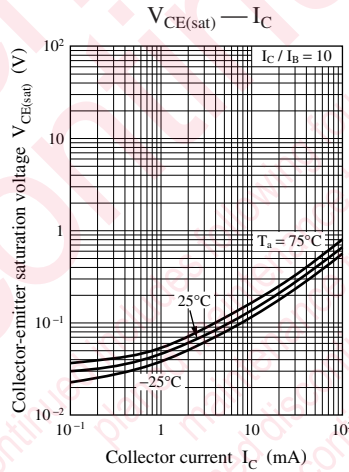
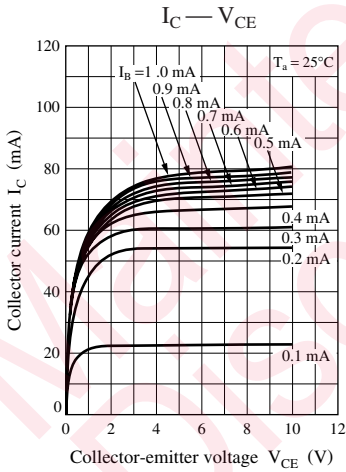

Characteristics charts of UNR9218G

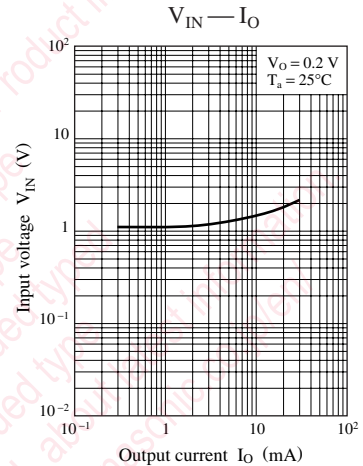
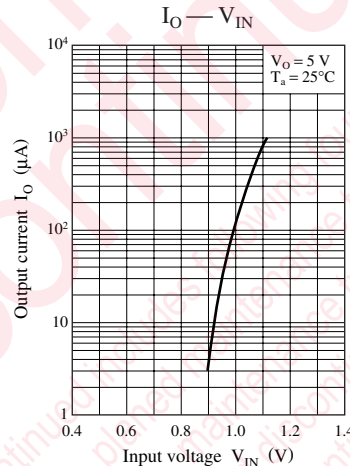
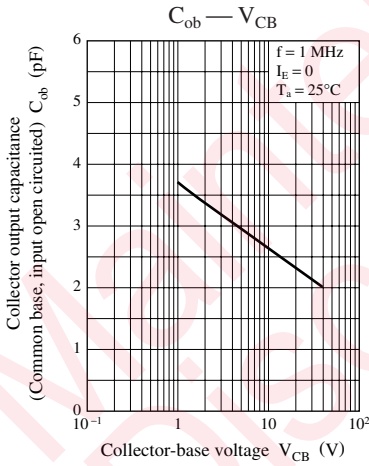
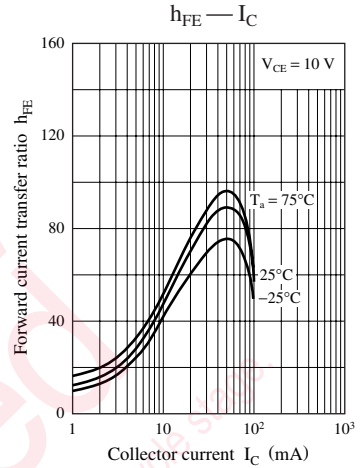
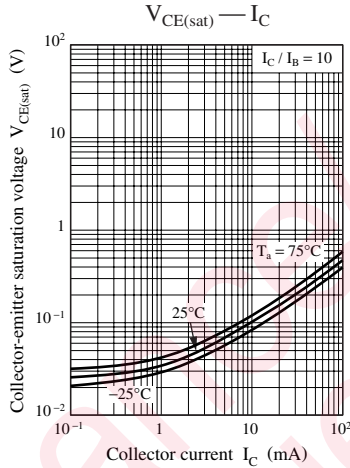
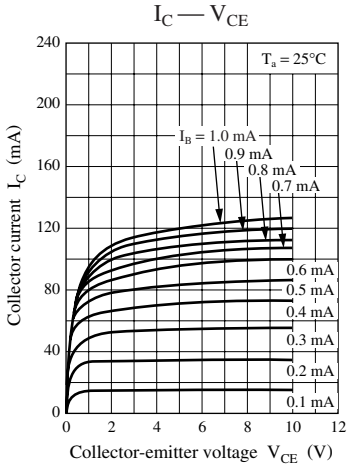

Characteristics charts of UNR9219G

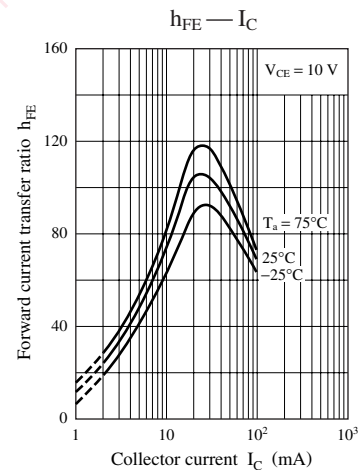
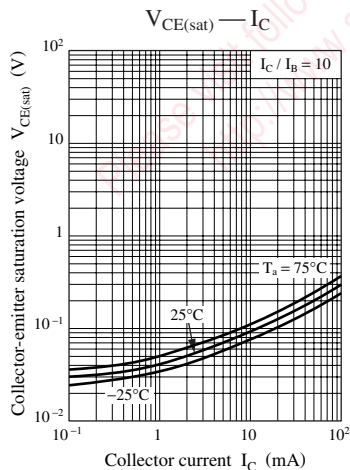
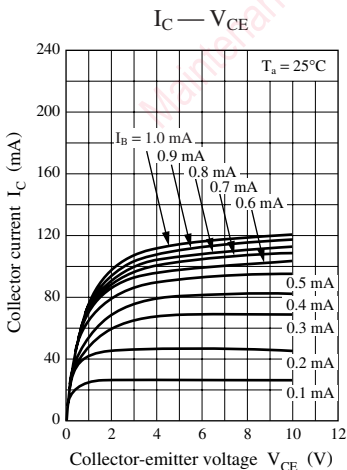

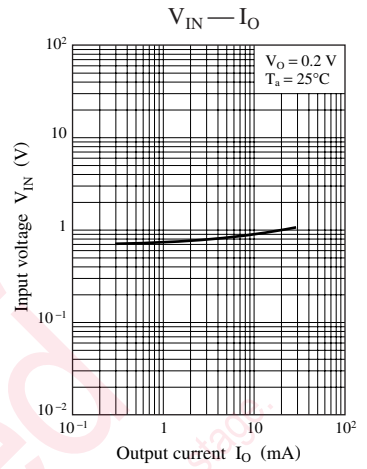
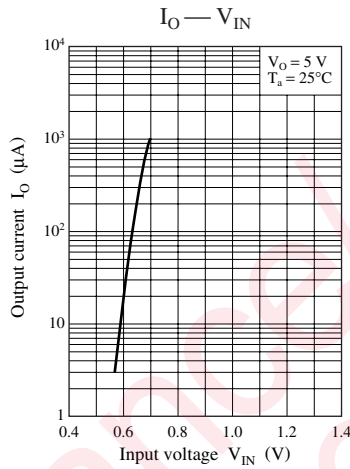
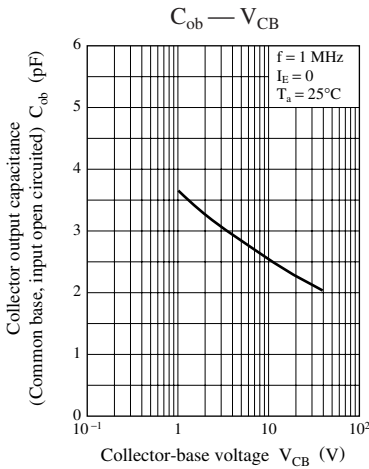

Characteristics charts of UNR921AG

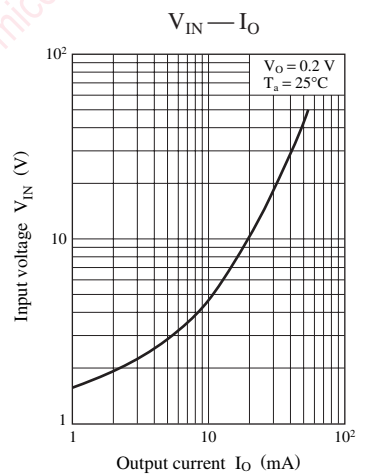
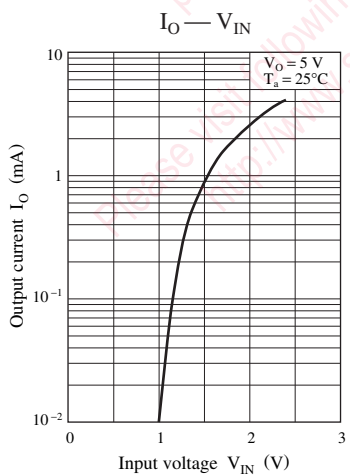
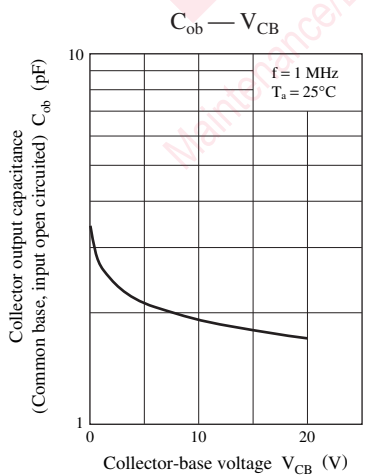
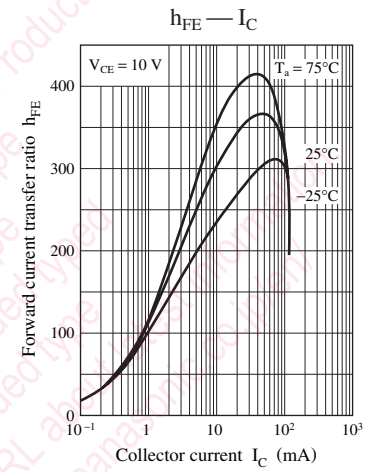
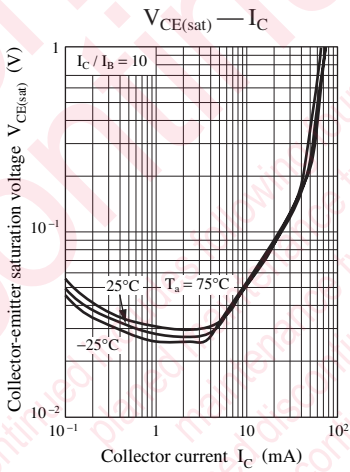
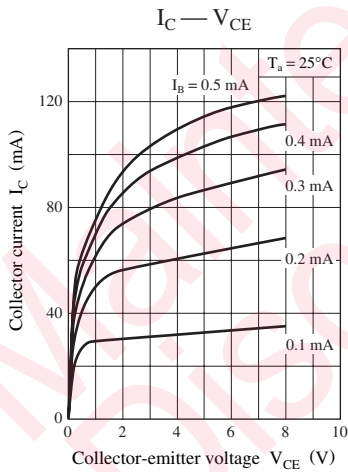

Characteristics charts of UNR921BG

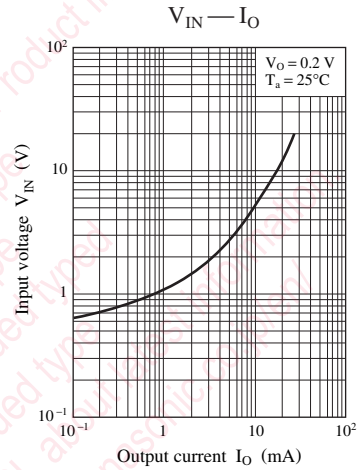
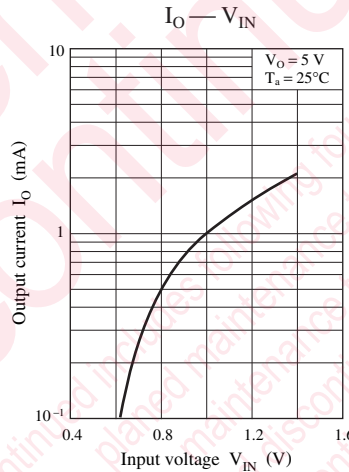
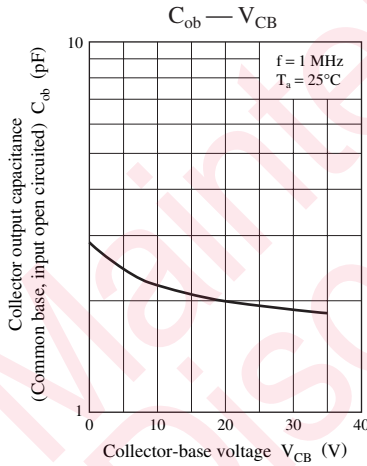
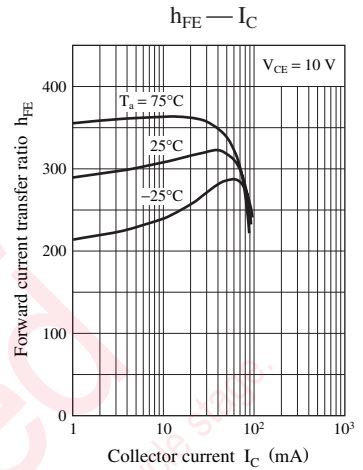
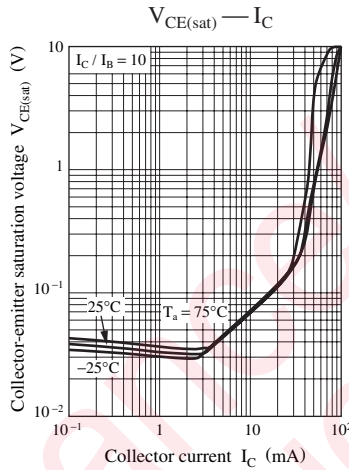
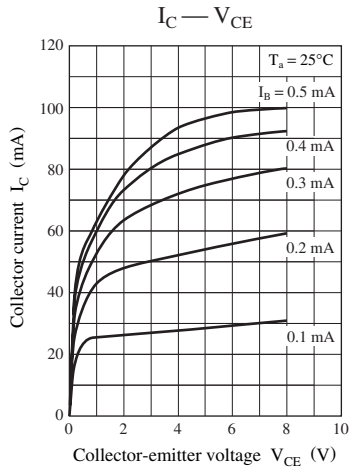

Characteristics charts of UNR921CG

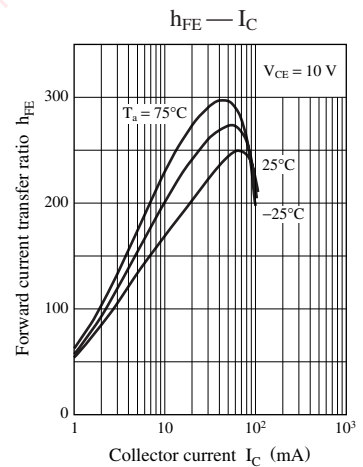
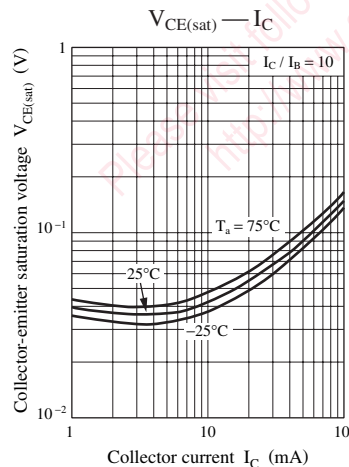
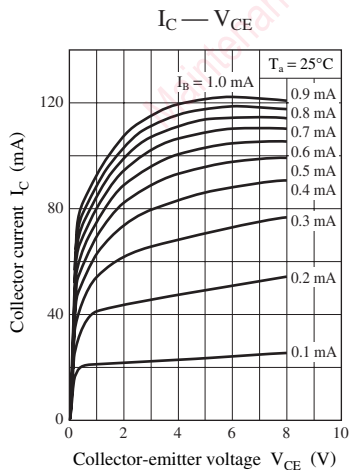

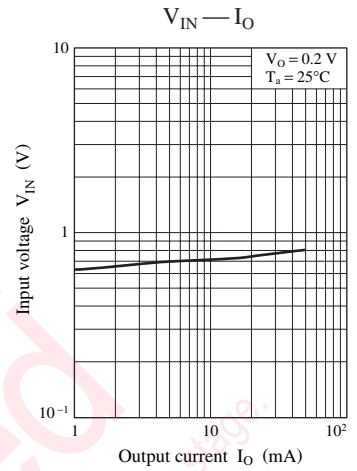
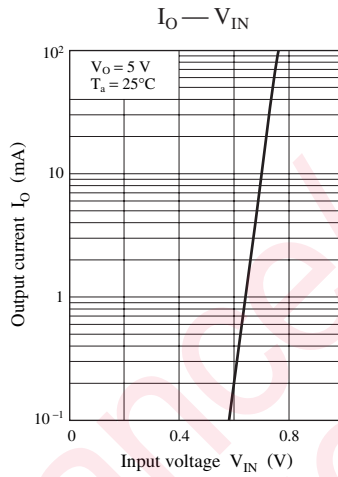
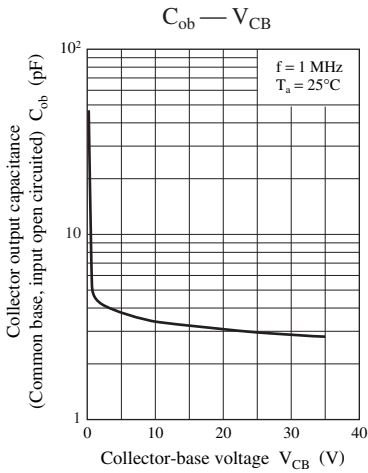

Characteristics charts of UNR921DG

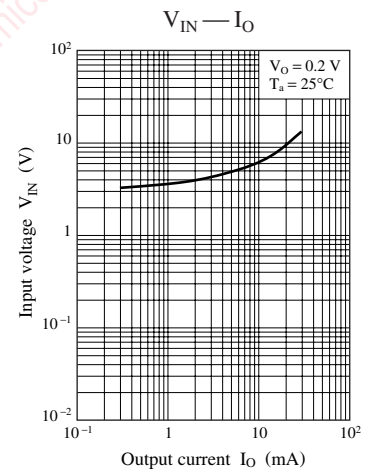
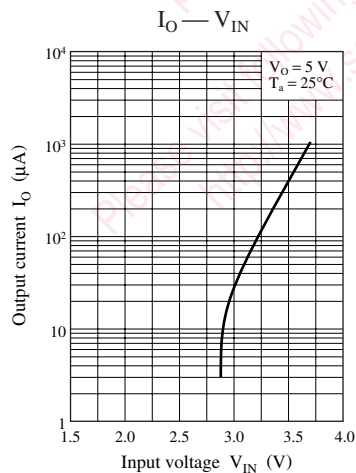
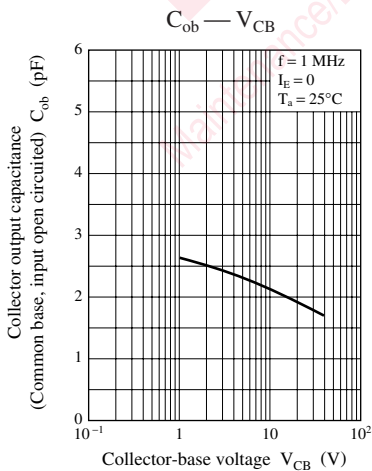
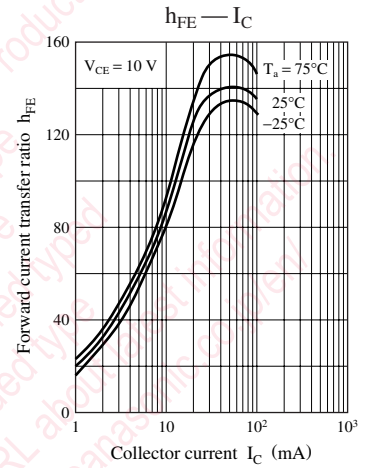
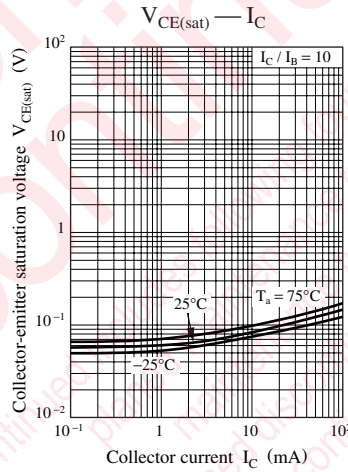
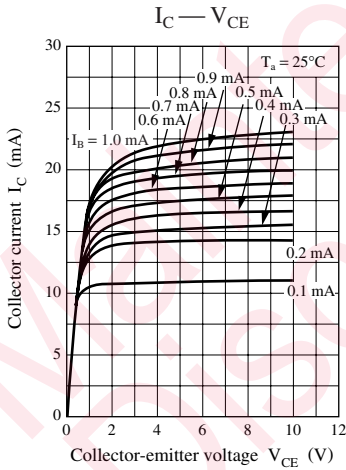

Characteristics charts of UNR921EG

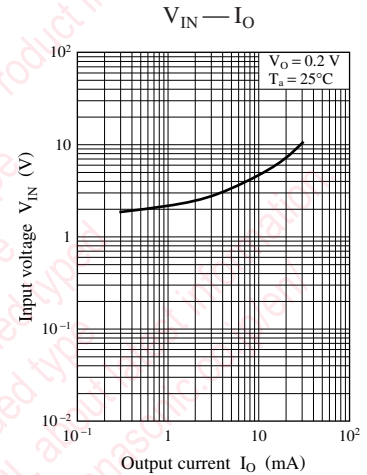
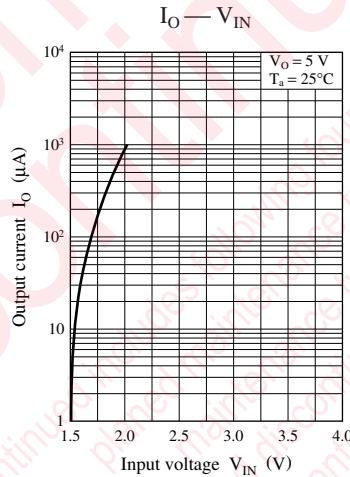
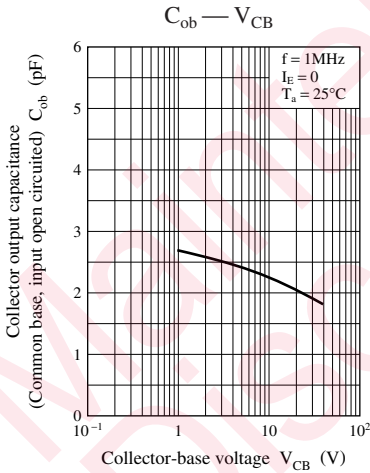
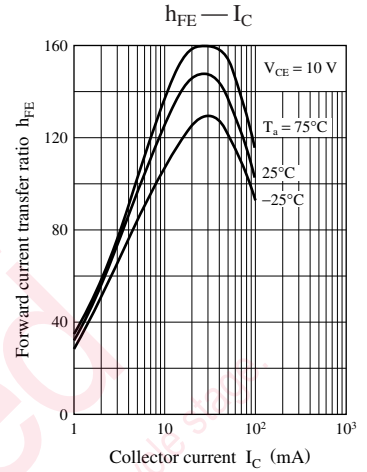
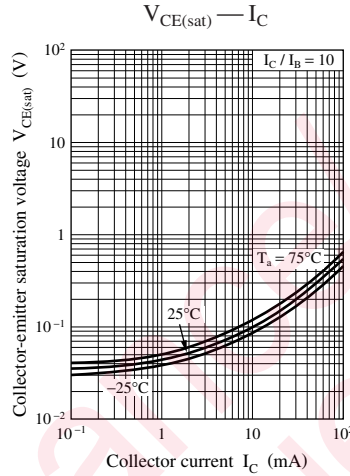
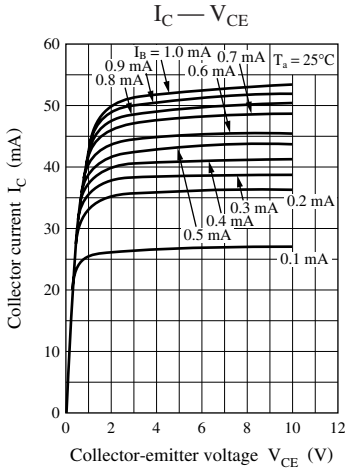

Characteristics charts of UNR921FG

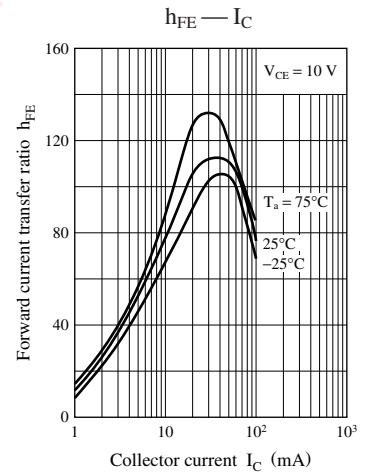
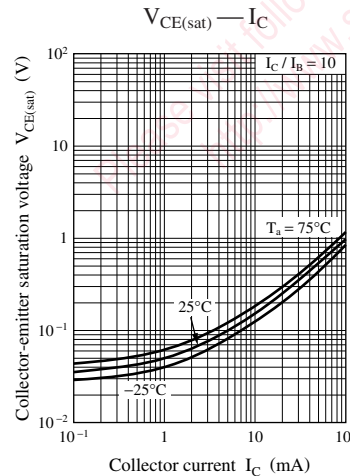
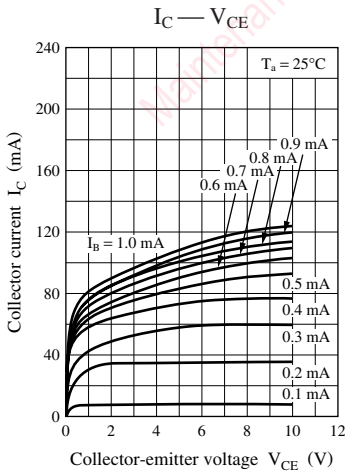

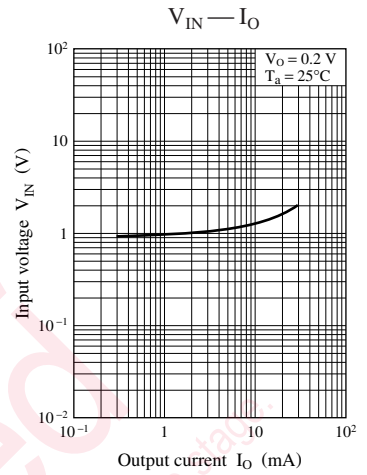
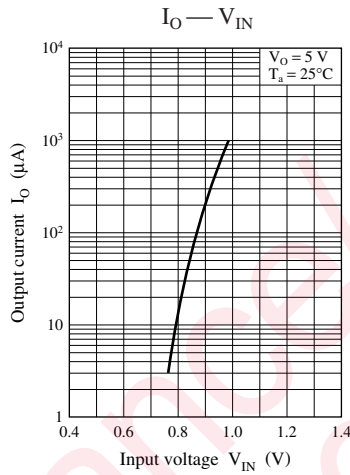
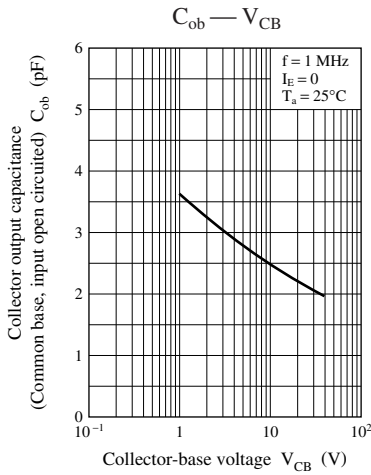

Characteristics charts of UNR921KG

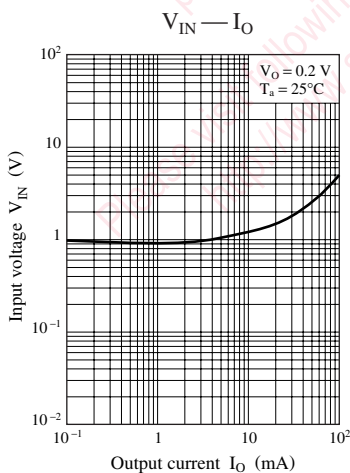
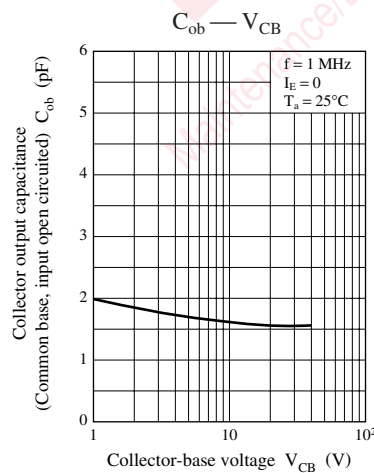
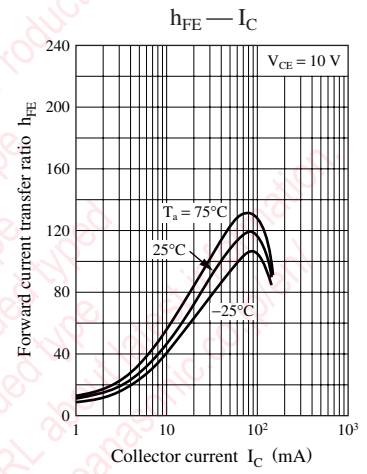
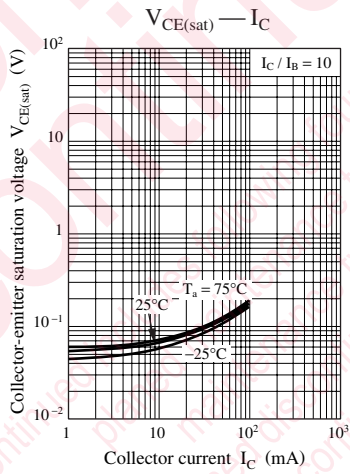
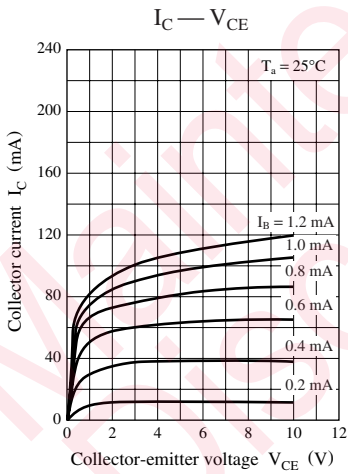

Characteristics charts of UNR921LG

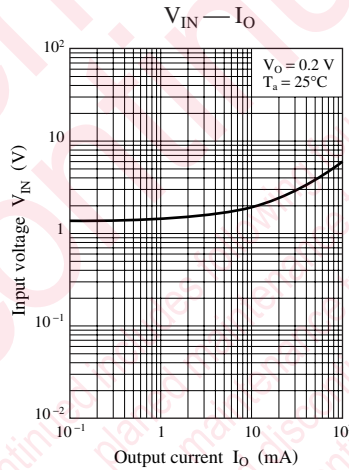
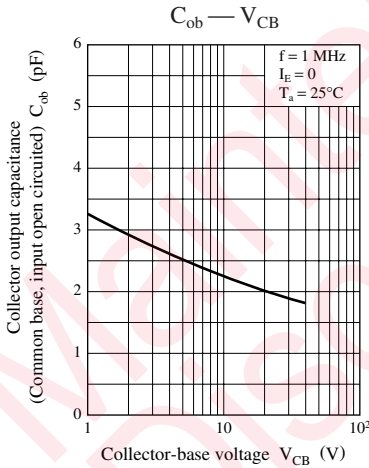
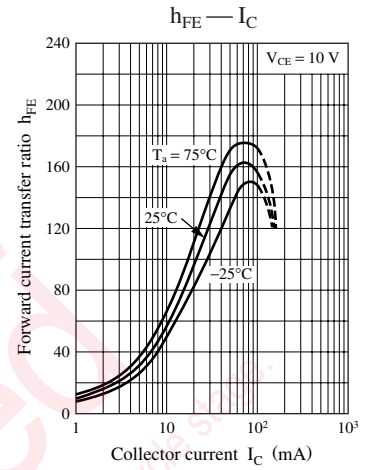
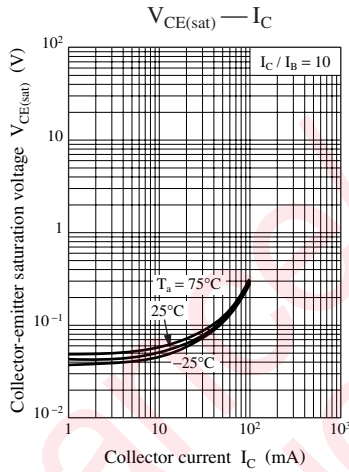
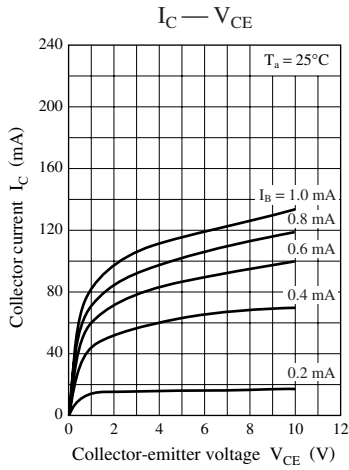

Characteristics charts of UNR921MG

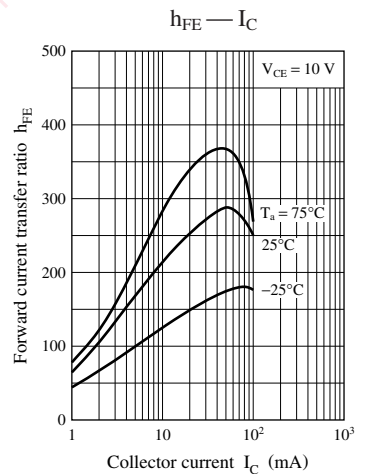
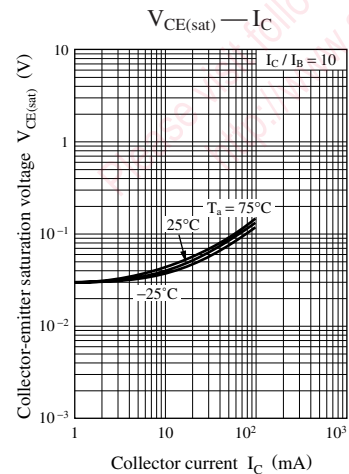
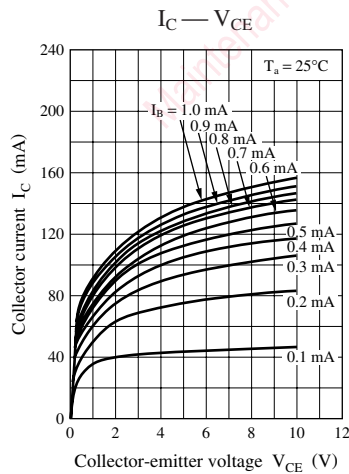

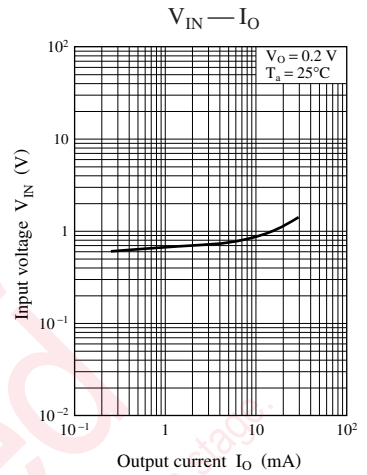
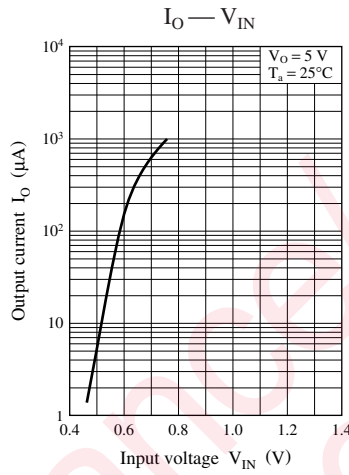
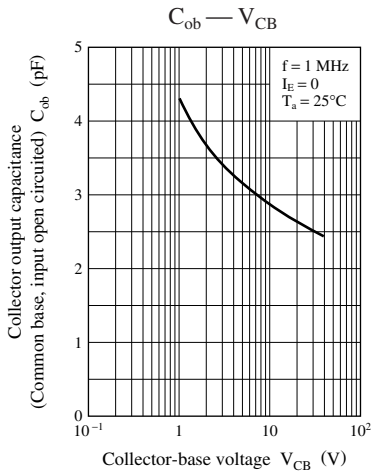

Characteristics charts of UNR921NG

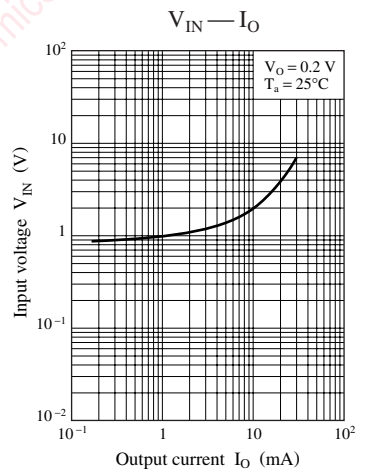
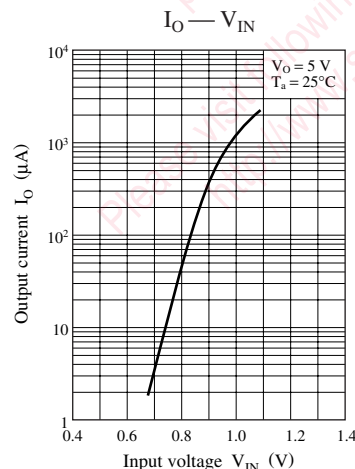
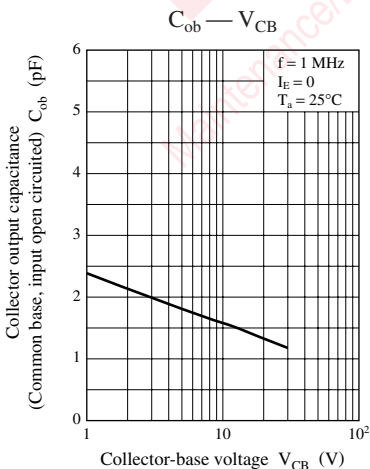
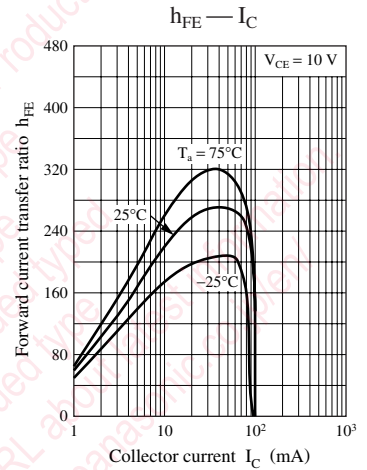
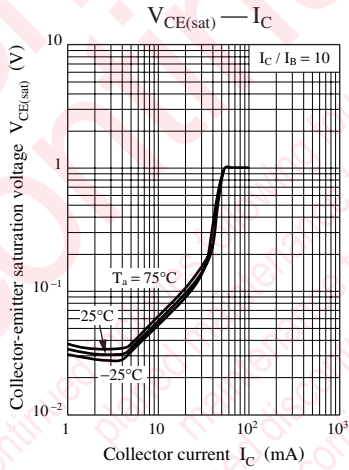
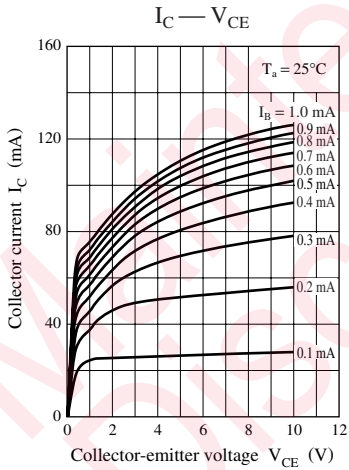

Characteristics charts of UNR921TG

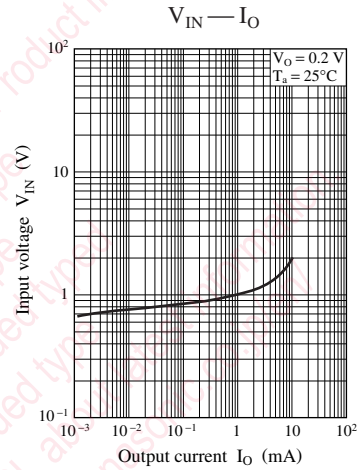
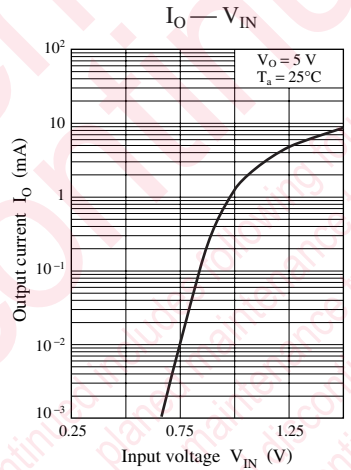
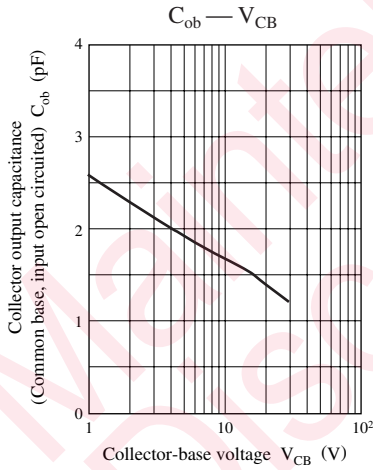
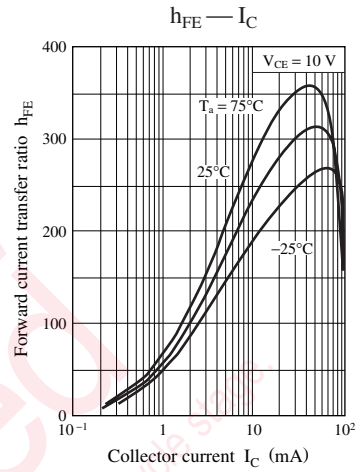
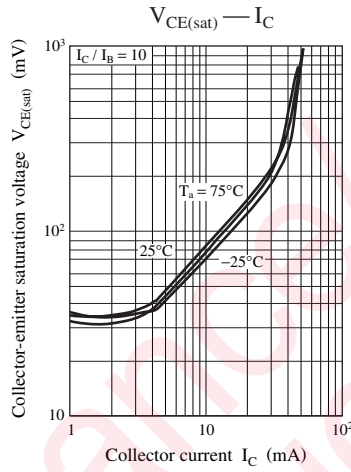
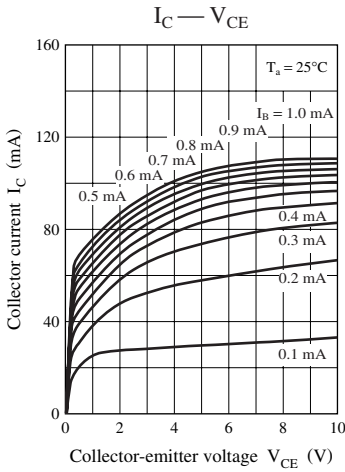

Characteristics charts of UNR921VG

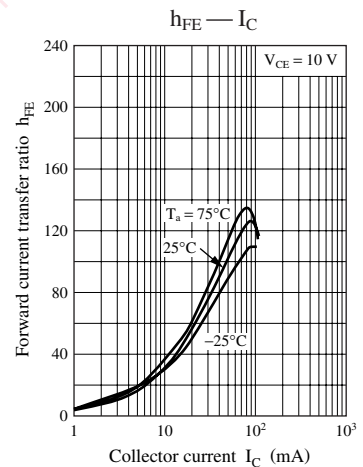
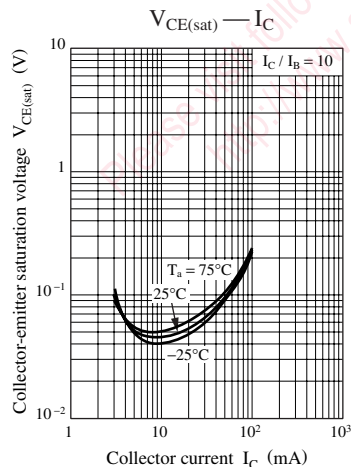
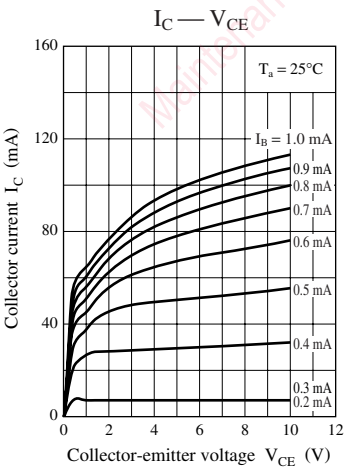

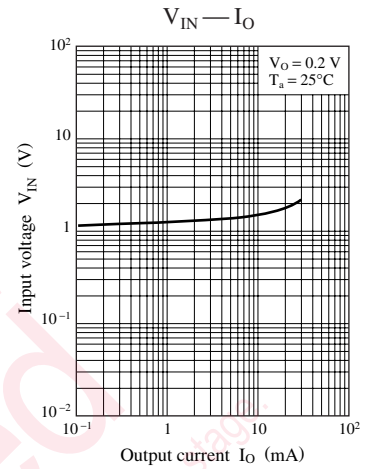
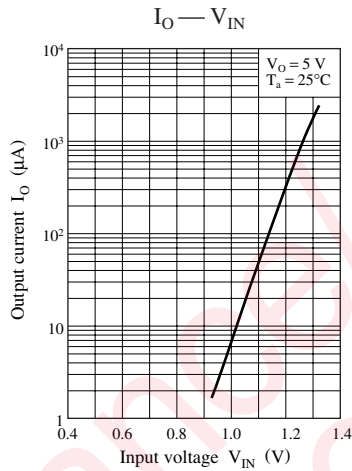
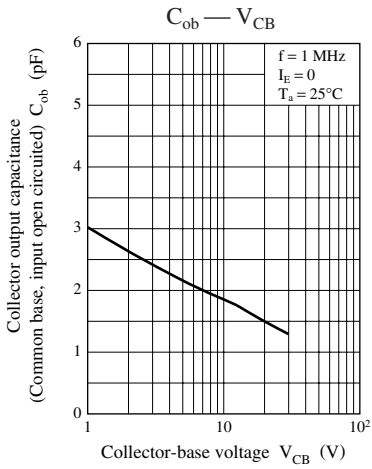

SSMini3-F3

Unit: mm

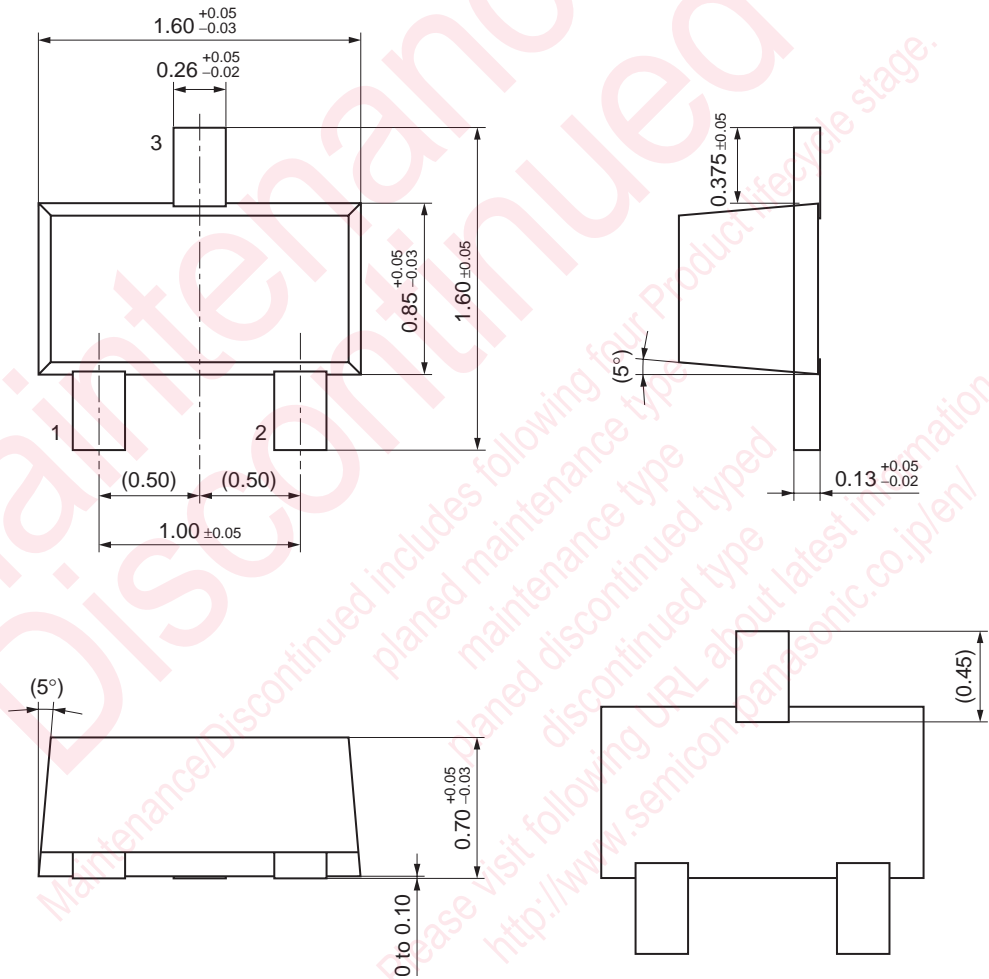

Precautions in using the technical information and products described in this book

This book is to be exported or provided to non-residents, the laws and regulations related to security export control, must be observed.

This book is intended to show the main characteristics and application circuit examples of the products. It does not constitute a warranty of any property right or other right owned by our company or any other party. We do not assume any liability for any infringement upon any such right owned by any other party. The information described in this book is for reference only.

This book describes standard applications or general electronic equipment (such as office equipment and household appliances).

Special applications:

Automobiles, traffic control equipment, combustion equipment, life support equipment, etc. Reliability and safety are required, or if the failure or malfunction of the product may cause serious damage to life or property.

Products are subject to change without notice for modification and/or improvement. Please use the products, therefore, ask for the most up-to-date Product Information Sheet to satisfy your requirements.

Do not exceed the absolute maximum rating and the guaranteed operating conditions (such as temperature range). Especially, please be careful not to exceed the range of absolute maximum ratings for turn-on and mode-switching. Otherwise, we will not be liable for any damage to the products.

Please take into the consideration of incidence of break down and failure of the products in the systems such as redundant design, arresting the spread of fire, prevention of personal injury, fire, social damages, for example, by using the products.

Product characteristics change due to external factors (ESD, EOS, etc.) during mounting or at customer's process. When using products for which the shelf life and the elapsed time since first opening the packages are specified, please refer to the shelf life and the elapsed time since first opening the packages.

Do not modify or partially modify the products without the prior written permission of Matsushita.







Looking for pricing, stock, or lifecycle information?

Click below to explore more details on WIN SOURCE:

 [View UNR921MG0L on WIN SOURCE](#)

 [Panasonic Information](#)

Optimize Your Supply Chain with WIN SOURCE Solutions

-  Global Sourcing Solution
-  Obsolete Management
-  Cost Control Management
-  Shortage Management
-  Alternative Solution
-  Excess Inventory Management