

TLE42344G

Low Dropout Linear Voltage Regulator

Data Sheet

Rev. 1.0, 2010-02-08

Automotive Power



1 Overview

Features

- Output voltage tolerance $\leq \pm 2\%$
- Low dropout voltage
- Output current up to 100 mA
- Very low current consumption
- Overtemperature shutdown
- Output current limitation
- Suitable for use in automotive electronics
- Reverse polarity protection
- Green Product (RoHS compliant)
- AEC Qualified

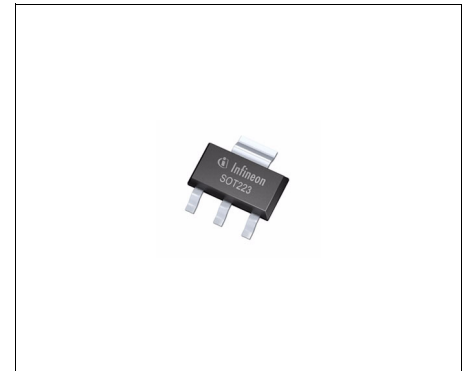

PG-SOT223-4

Functional Description

TLE42344G is a 5 V low dropout fixed voltage regulator in an PG-SOT223-4 package. The IC regulates an input voltage V_I in the range $5.5 \text{ V} < V_I < 45 \text{ V}$ to $V_{Qrated} = 5.0 \text{ V}$. The maximum output current is more than 100 mA. This IC is protected against shortcircuit and overheat by the integrated output current limitation and the overtemperature shutdown

Dimensioning Information on External Components

The input capacitor C_I is necessary for compensating line influences. The output capacitor C_Q is necessary for the stability of the regulating circuit. Stability is guaranteed at values $C_Q \geq 10 \mu\text{F}$ and an $\text{ESR} \leq 10 \Omega$ within the operating temperature range.

Circuit Description

The control amplifier compares a reference voltage, which is kept highly precise by resistance adjustment, to a voltage that is proportional to the output voltage and drives the base of the series transistor via a buffer. Saturation control, working as a function of load current, prevents any over-saturation of the power element.

Type	Package	Marking
TLE42344G	PG-SOT223-4	42344

2 Block Diagram

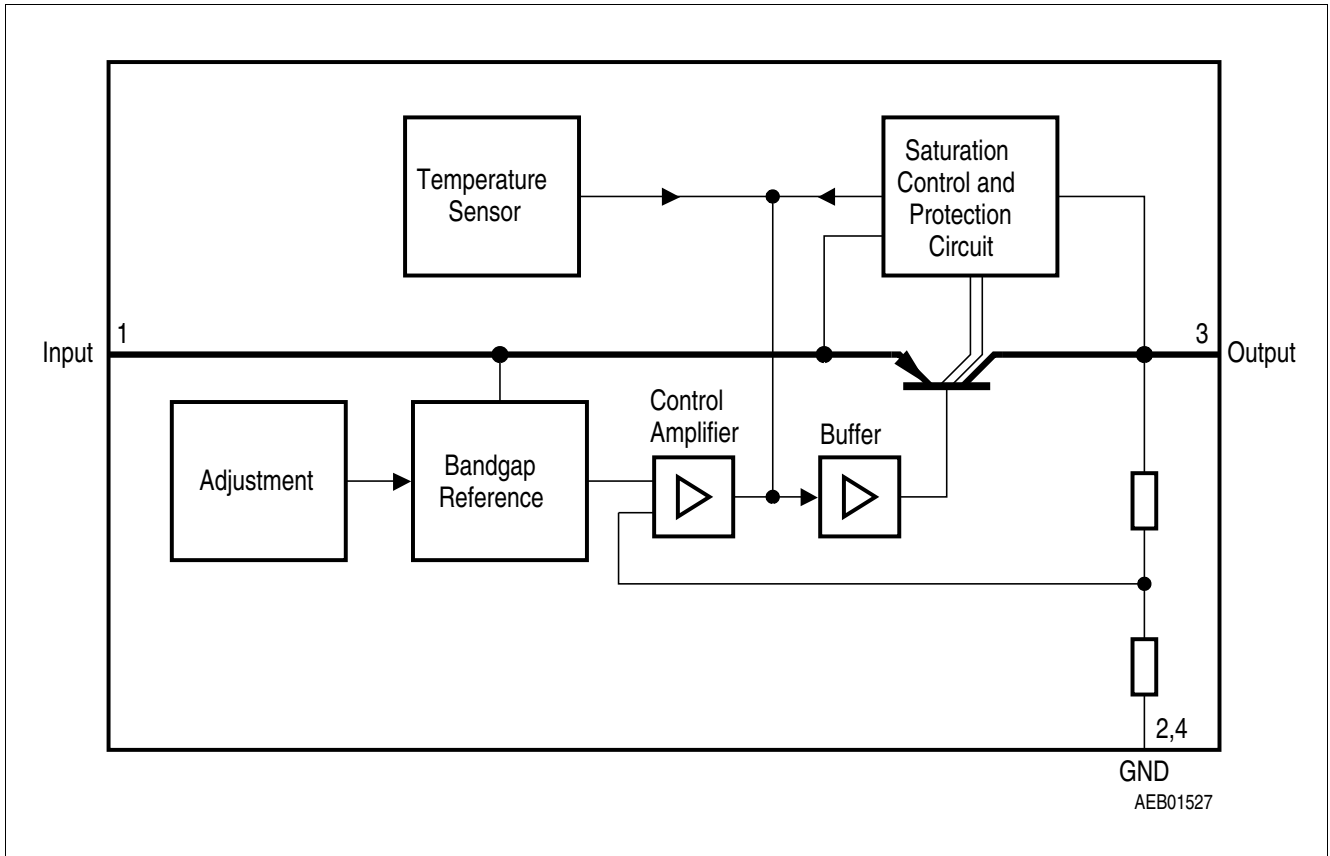

Figure 1 Block Diagram

3 Pin Configuration

3.1 Pin Assignment

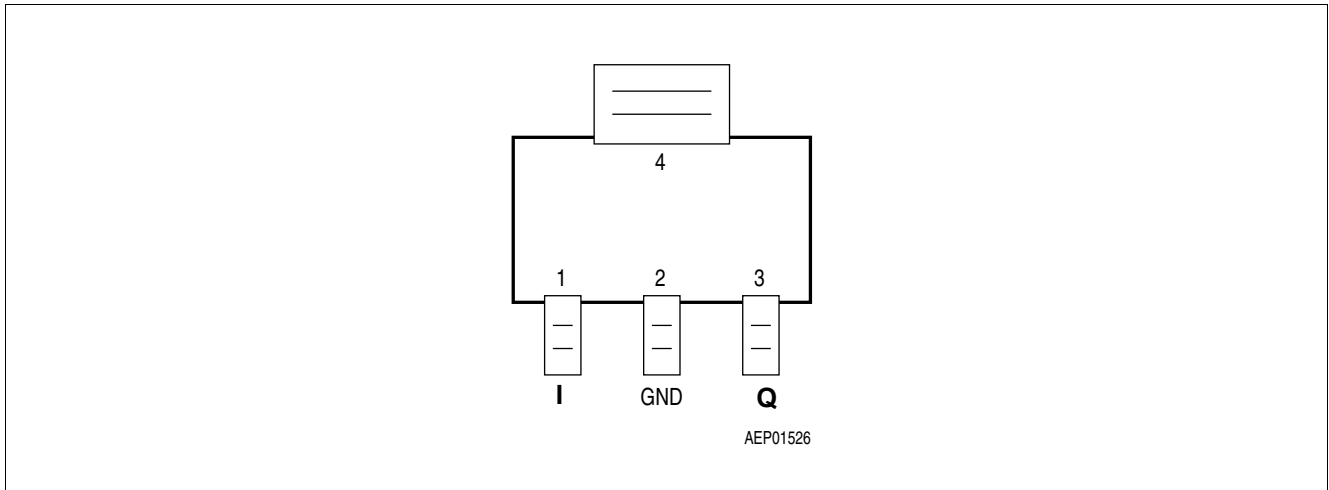

Figure 2 Pin Configuration

3.2 Pin Definitions and Functions

Pin	Symbol	Function
1	I	Input Voltage ; block to ground directly on IC with ceramic capacitor
2, 4	GND	Ground
3	Q	5 V Output Voltage ; block to ground with $\geq 10 \mu\text{F}$ capacitor, $\text{ESR} \leq 10 \Omega$

4 General Product Characteristics

4.1 Absolute Maximum Ratings

Absolute Maximum Ratings ¹⁾

$T_j = -40\text{ °C}$ to $+150\text{ °C}$; all voltages with respect to ground, positive current flowing into pin (unless otherwise specified)

Pos.	Parameter	Symbol	Limit Values		Unit	Conditions
			Min.	Max.		
Input						
4.1.1	Input voltage	V_I	-30	45	V	–
Output						
4.1.2	Output voltage	V_Q	-1	32	V	–
Temperatures						
4.1.3	Junction Temperature	T_j	-40	150	°C	–
4.1.4	Storage Temperature	T_{stg}	-50	150	°C	–
ESD Susceptibility						
4.1.5	ESD Resistivity to GND	V_{ESD}	-4	4	kV	HBM ²⁾
4.1.6	ESD Resistivity to GND	V_{ESD}	-1.5	1.5	kV	CDM ³⁾

1) Not subject to production test, specified by design.

2) ESD susceptibility, HBM according to EIA/JESD 22-A114B

3) ESD susceptibility, Charged Device Model "CDM" EIA/JESD22-C101 or ESDA STM5.3.1

Note: Stresses above the ones listed here may cause permanent damage to the device. Exposure to absolute maximum rating conditions for extended periods may affect device reliability.

Note: Integrated protection functions are designed to prevent IC destruction under fault conditions described in the data sheet. Fault conditions are considered as "outside" normal operating range. Protection functions are not designed for continuous repetitive operation.

4.2 Functional Range

Table 1 Functional Range

Pos.	Parameter	Symbol	Limit Values		Unit	Conditions
			Min.	Max.		
4.2.1	Input Voltage	V_I	5.5	45	V	
4.2.2	Junction Temperature	T_j	-40	150	°C	–

Note: Within the functional or operating range, the IC operates as described in the circuit description. The electrical characteristics are specified within the conditions given in the Electrical Characteristics table.

4.3 Thermal Resistance

Note: This thermal data was generated in accordance with JEDEC JESD51 standards. For more information, go to www.jedec.org.

Pos.	Parameter	Symbol	Limit Values			Unit	Conditions
			Min.	Typ.	Max.		
4.3.1	Junction to Case ¹⁾	R_{thJC}	–	17	–	K/W	measured to heat slug
4.3.2	Junction to Ambient ¹⁾	R_{thJA}	–	54	–	K/W	²⁾
4.3.3			–	139	–	K/W	footprint only ³⁾
4.3.4			–	73	–	K/W	300 mm ² heatsink area ³⁾
4.3.5			–	64	–	K/W	600 mm ² heatsink area ³⁾

1) Not subject to production test, specified by design.

2) Specified R_{thJA} value is according to Jedec JESD51-2,-5,-7 at natural convection on FR4 2s2p board; The Product (Chip+Package) was simulated on a 76.2 x 114.3 x 1.5 mm³ board with 2 inner copper layers (2 x 70µm Cu, 2 x 35µm Cu). Where applicable a thermal via array under the exposed pad contacted the first inner copper layer.

3) Specified R_{thJA} value is according to Jedec JESD 51-3 at natural convection on FR4 1s0p board; The Product (Chip+Package) was simulated on a 76.2 x 114.3 x 1.5 mm³ board with 1 copper layer (1 x 70µm Cu).

5 Electrical Characteristics

5.1 Electrical Characteristics Voltage Regulator

Electrical Characteristics:

$V_1 = 13.5\text{ V}$, $T_j = -40\text{ °C}$ to $+150\text{ °C}$, all voltages with respect to ground, positive current flowing into pin (unless otherwise specified)

Pos.	Parameter	Symbol	Limit Values			Unit	Conditions
			Min.	Typ.	Max.		
5.1.1	Output voltage	V_Q	4.9	5.0	5.1	V	$5\text{ mA} \leq I_Q \leq 100\text{ mA}$ $6\text{ V} \leq V_1 \leq 28\text{ V}$
5.1.2	Output current limitation	I_Q	120	160	–	mA	–
5.1.3	Current consumption $I_q = I_1 - I_Q$	I_q	–	–	400	μA	$I_Q = 1\text{ mA}$
5.1.4	Current consumption $I_q = I_1 - I_Q$	I_q	–	9	15	mA	$I_Q = 100\text{ mA}$
5.1.5	Drop voltage	V_{dr}	–	0.25	0.5	V	$I_Q = 100\text{ mA}^{1)}$
5.1.6	Load regulation	ΔV_Q	–	–	40	mV	$I_Q = 5\text{ to }100\text{ mA}$ $V_1 = 6\text{ V}$
5.1.7	Line regulation	ΔV_Q	–	15	30	mV	$V_1 = 6\text{ to }28\text{ V}$ $I_Q = 5\text{ mA}$
5.1.8	Power Supply ripple rejection	$PSRR$	–	54	–	dB	$f_r = 100\text{ Hz}$ $V_r = 0.5\text{ Vpp}$

1) Drop voltage = $V_1 - V_Q$ (measured where V_Q has dropped 100 mV from the nominal value obtained at $V_1 = 13.5\text{ V}$).

5.2 Typical Performance Characteristics Voltage Regulator

Dropout Voltage V_{DR} versus Output Current I_Q

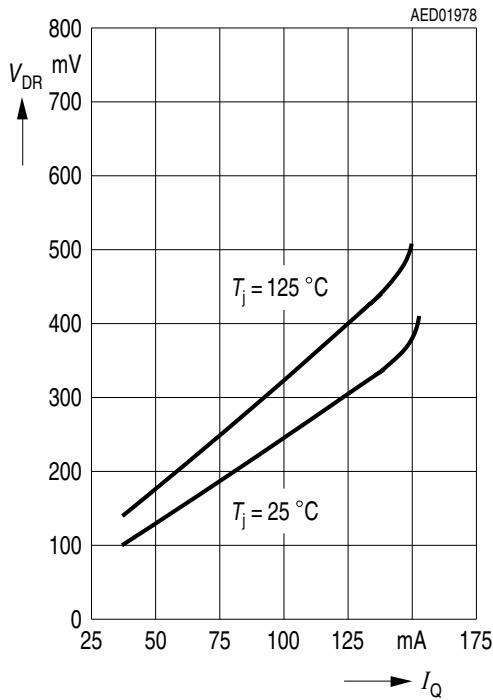

Current Consumption I_q versus Input Voltage V_I

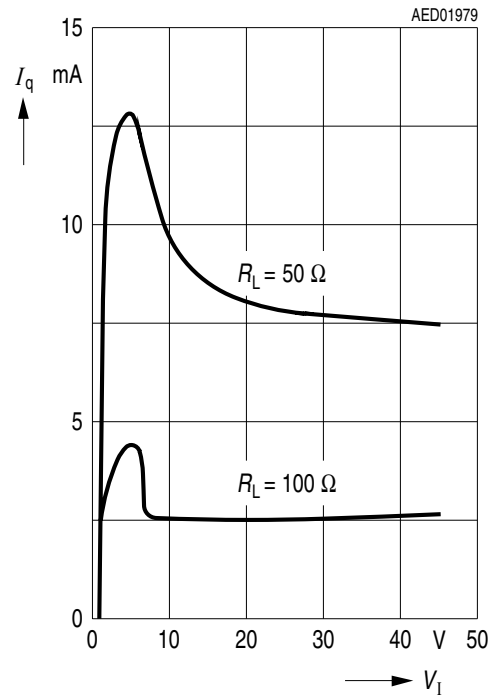

Current Consumption I_q versus Output Current I_Q

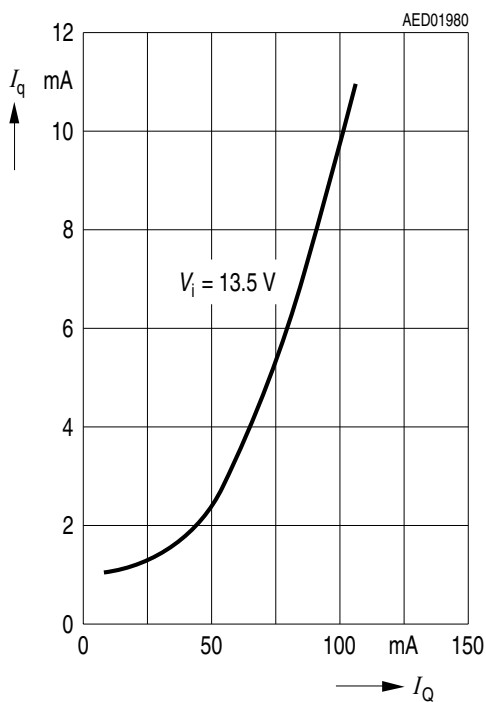

Current Consumption I_q versus Output Current I_Q

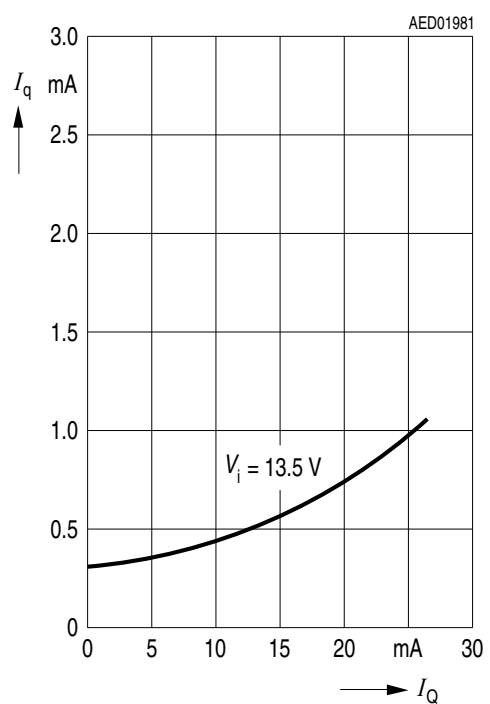

Output Voltage V_Q versus Temperature T_j

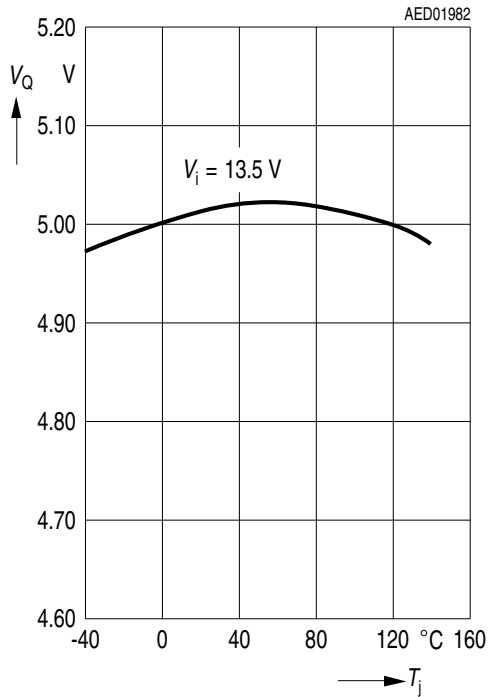

Output Current I_Q versus Input Voltage V_I

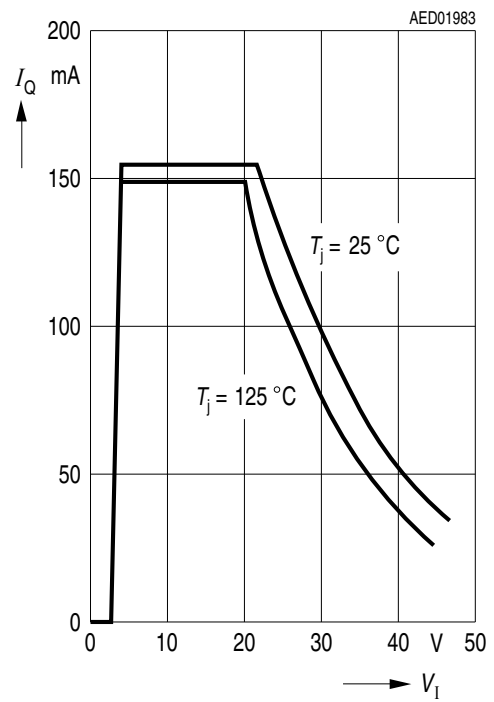

Output Voltage V_Q versus Input Voltage V_I

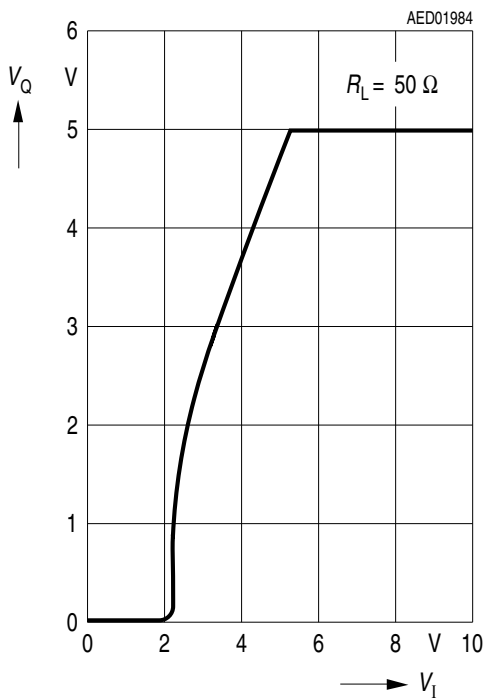

6 Application Information

Note: The following information is given as a hint for the implementation of the device only and shall not be regarded as a description or warranty of a certain functionality, condition or quality of the device.

(1)

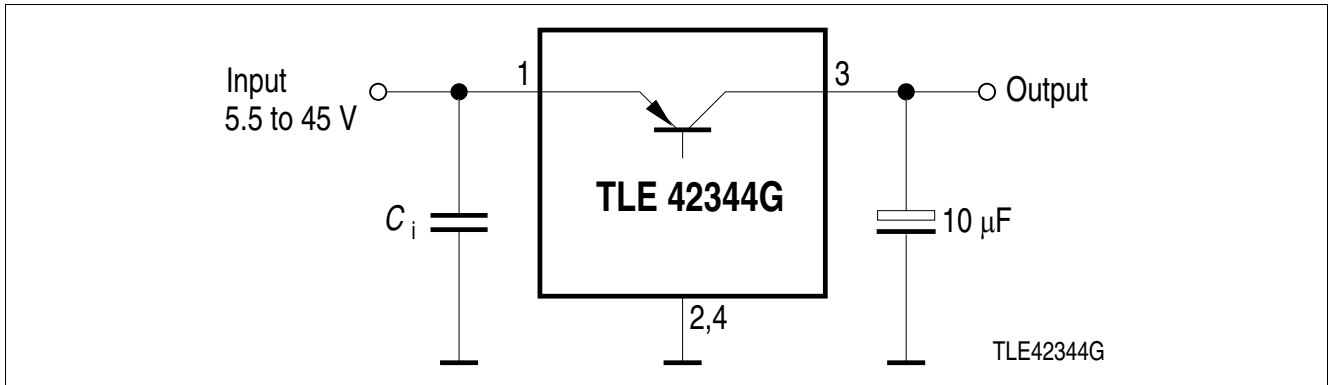

Figure 3 Application Diagram

Note: This is a very simplified example of an application circuit. The function must be verified in the real application.

6.1 Further Application Information

- For further information you may contact <http://www.infineon.com/>

7 Package Outlines

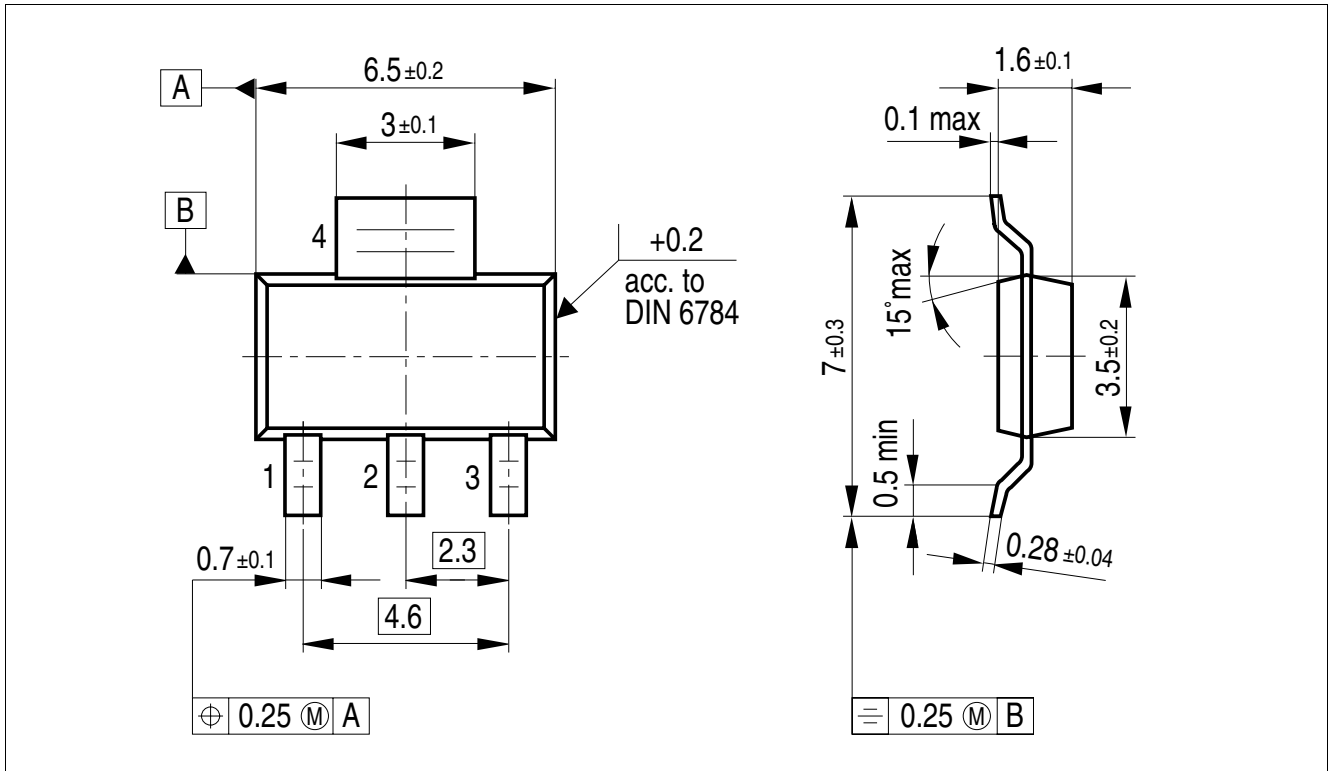

Figure 4 PG-SOT223-4 (Plastic Small Outline Transistor)

Green Product (RoHS compliant)

To meet the world-wide customer requirements for environmentally friendly products and to be compliant with government regulations the device is available as a green product. Green products are RoHS-Compliant (i.e. Pb-free finish on leads and suitable for Pb-free soldering according to IPC/JEDEC J-STD-020).

8 Revision History

Revision	Date	Changes
1.0	2010-02-08	Initial data sheet

Edition 2010-02-08

**Published by
Infineon Technologies AG
81726 Munich, Germany**

**© 2010 Infineon Technologies AG
All Rights Reserved.**

Legal Disclaimer

The information given in this document shall in no event be regarded as a guarantee of conditions or characteristics. With respect to any examples or hints given herein, any typical values stated herein and/or any information regarding the application of the device, Infineon Technologies hereby disclaims any and all warranties and liabilities of any kind, including without limitation, warranties of non-infringement of intellectual property rights of any third party.

Information

For further information on technology, delivery terms and conditions and prices, please contact the nearest Infineon Technologies Office (www.infineon.com).



Warnings

Due to technical requirements, components may contain dangerous substances. For information on the types in question, please contact the nearest Infineon Technologies Office.

Infineon Technologies components may be used in life-support devices or systems only with the express written approval of Infineon Technologies, if a failure of such components can reasonably be expected to cause the failure of that life-support device or system or to affect the safety or effectiveness of that device or system. Life support devices or systems are intended to be implanted in the human body or to support and/or maintain and sustain and/or protect human life. If they fail, it is reasonable to assume that the health of the user or other persons may be endangered.

Looking for pricing, stock, or lifecycle information?

Click below to explore more details on WIN SOURCE:

-  [View TLE42344GHTSA1 on WIN SOURCE](#)
-  [Infineon Technologies Information](#)

Optimize Your Supply Chain with WIN SOURCE Solutions

-  Global Sourcing Solution
-  Obsolete Management
-  Cost Control Management
-  Shortage Management
-  Alternative Solution
-  Excess Inventory Management