



**THE DATASHEET OF
MIC5216-3.6YM5-TR**



General Description

The MIC5216 is an efficient linear voltage regulator with high peak output current capability, very low dropout voltage, and better than 1% output voltage accuracy. Dropout is typically 10mV at light loads and less than 500mV at full load.

The MIC5216 is designed to provide a peak output current for startup conditions where higher inrush current is demanded. It features a 500mA peak output rating. Continuous output current is limited only by package and layout.

The MIC5216 has an internal undervoltage monitor with a flag output. It also can be enabled or shutdown by a CMOS or TTL compatible signal. When disabled, power consumption drops nearly to zero. Dropout ground current is minimized to help prolong battery life. Other key features include reversed-battery protection, current limiting, overtemperature shutdown, and low noise performance.

The MIC5216 is available in fixed output voltages in space-saving SOT-23-5 and MM8™ 8-pin power MSOP packages. For higher power requirements see the MIC5209 or MIC5237.

Data sheets and support documentation can be found on Micrel's web site at www.micrel.com.

Features

- Error Flag indicates undervoltage fault
- Guaranteed 500mA-peak output over the full operating temperature range
- Low 500mV maximum dropout voltage at full load
- Extremely tight load and line regulation
- Tiny SOT-23-5 and MM8™ power MSOP-8 package
- Low-noise output
- Low temperature coefficient
- Current and thermal limiting
- Reversed input polarity protection
- CMOS/TTL-compatible enable/shutdown control
- Near-zero shutdown current

Applications

- Laptop, notebook, and palmtop computers
- Cellular telephones and battery-powered equipment
- Consumer and personal electronics
- PC Card V_{CC} and V_{PP} regulation and switching
- SMPS post-regulator/dc-to-dc modules
- High-efficiency linear power supplies

Typical Application

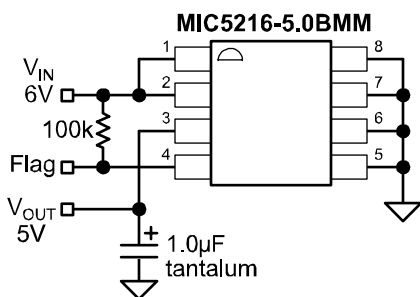

5V Low-Noise Regulator

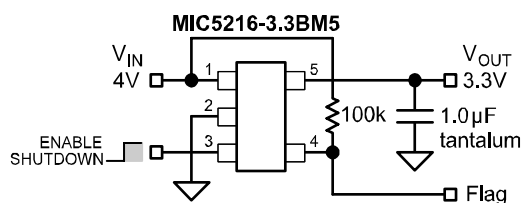

3.3V Low-Noise Regulator

Ordering Information

Part Number				Voltage	Junction Temp. Range	Package
Standard	Marking	Pb-Free	Marking			
MIC5216-2.5BMM		MIC5216-2.5YMM		2.5V	-40° to +125°C	8-Pin MSOP
MIC5216-3.3BMM		MIC5216-3.3YMM		3.3V	-40° to +125°C	8-Pin MSOP
MIC5216-5.0BMM		MIC5216-5.0YMM		5.0V	-40° to +125°C	8-Pin MSOP
MIC5216-2.5BM5	LH25	MIC5216-2.5YM5	<u>LH25</u>	2.5V	-40° to +125°C	5-Pin SOT-23
MIC5216-3.3BM5	LH33	MIC5216-3.3YM5	<u>LH33</u>	3.3V	-40° to +125°C	5-Pin SOT-23
MIC5216-3.6BM5	LH36	MIC5216-3.6YM5	<u>LH36</u>	3.6V	-40° to +125°C	5-Pin SOT-23
MIC5216-5.0BM5	LH50	MIC5216-5.0YM5	<u>LH50</u>	5.0V	-40° to +125°C	5-Pin SOT-23

Pin Configuration

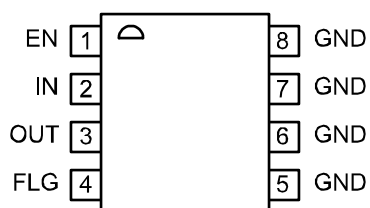

MIC5216-xxBMM/YMM
MM8™ MSOP-8
Fixed Voltages

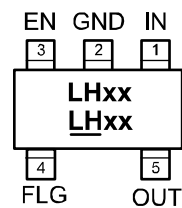

MIC5216-xxBM5/YM5
SOT-23-5
Fixed Voltages

Pin Description

Pin Number MSOP-8	Pin Number SOT-23-5	Pin Name	Pin Function
2	1	IN	Supply Input
5–8	2	GND	Ground: MSOP-8 pins 5 through 8 are internally connected.
3	5	OUT	Regulator Output
1	3	EN	Enable (Input): CMOS compatible control input. Logic high = enable; logic low or open = shutdown.
4	4	FLG	Error Flag (Output): Open-Collector output. Active low indicates an output undervoltage condition.

Absolute Maximum Ratings

Supply Input Voltage (V_{IN})..... –20V to +20V
 Power Dissipation (P_D)..... Internally Limited
 Junction Temperature (T_J) –40°C to +125°C
 Lead Temperature (soldering, 5 sec.)..... 260°C

Operating Ratings

Supply Input Voltage (V_{IN})..... 2.5V to 12V
 Enable Input Voltage (V_{EN})..... 0V to V_{IN}
 Junction Temperature (T_J) –40°C to +125°C
 Thermal Resistance (θ_{JA})..... **Note 1**

Electrical Characteristics

$V_{IN} = V_{OUT} + 1V$; $C_{OUT} = 4.7\mu F$; $I_{OUT} = 100\mu A$; $T_J = 25^\circ C$, **bold** values indicate $-40^\circ C \leq T_J \leq +125^\circ C$, unless noted.

Symbol	Parameter	Condition	Min	Typ	Max	Units
V_O	Output Voltage Accuracy	Variation from nominal V_{OUT}	–1 –2		1 2	% %
$\Delta V_O/\Delta T$	Output Voltage Temperature Coefficient	Note 2		40		ppm/°C
$\Delta V_O/V_O$	Line Regulation	$V_{IN} = V_{OUT} + 1V$ to 12V		0.009	0.05 0.1	%/V %/V
$\Delta V_O/V_O$	Load Regulation	$I_{OUT} = 100\mu A$ to 150mA (Note 3)		0.05	0.5 0.7	% %
$V_{IN} - V_O$	Dropout Voltage, Note 4	$I_{OUT} = 100\mu A$ $I_{OUT} = 50mA$ $I_{OUT} = 150mA$ $I_{OUT} = 500mA$		10 115 165 300	60 80 175 250 300 400 500 600	mV mV mV mV mV mV
I_{GND}	Ground Pin Current, Notes 5, 6 (per regulator)	$V_{EN} \geq 3.0V$, $I_{OUT} = 100\mu A$ $V_{EN} \geq 3.0V$, $I_{OUT} = 50mA$ $V_{EN} \geq 3.0V$, $I_{OUT} = 150mA$ $V_{EN} \geq 3.0V$, $I_{OUT} = 500mA$		80 350 1.8 8	130 170 650 900 2.5 3.0 20 25	μA μA μA μA mA mA mA mA
I_{GND}	Quiescent Current, Note 6	$V_{EN} \leq 0.4V$ $V_{EN} \leq 0.18V$		0.05 0.10	3 8	μA μA
PSRR	Ripple Rejection	Frequency = 120Hz		75		dB
I_{LIMIT}	Current Limit	$V_{OUT} = 0V$		700	1000	mA
$\Delta V_O/\Delta P_D$	Thermal Regulation	Note 7		0.05		%/W
e_{no}	Output Noise	$I_{OUT} = 50mA$, $C_{OUT} = 2.2\mu F$		500		nV/ \sqrt{Hz}

Symbol	Parameter	Condition	Min	Typ	Max	Units
Enable Input						
V _{ENL}	Enable Input Voltage	V _{EN} = logic low (regulator shutdown)			0.4 0.18	V V
V _{ENH}		V _{EN} = logic high (regulator enabled)	2.0			V
I _{ENL} I _{ENH}	Enable Input Current	V _{ENL} ≤ 0.4V V _{ENL} ≤ 0.18V V _{ENH} ≥ 2.0V		0.01 0.01 5	-1 -2 20 25	μA μA μA μA
Error Flag Output						
V _{ERR}	Flag Threshold	Undervoltage condition (below nominal) Note 8	-2	-6	-10	%
V _{IL}	Output Logic-Low Voltage	I _L = 1mA, undervoltage condition		0.2	0.4	V
I _{FL}	Flag Leakage Current	Flag off, V _{FLAG} = 0V to 12V	-1	0.1	+1	μA

Notes:

- Absolute maximum ratings indicate limits beyond which damage to the component may occur. Electrical specifications do not apply when operating the device outside of its operating ratings. The maximum allowable power dissipation is a function of the maximum junction temperature, T_{J(max)}, the junction-to-ambient thermal resistance, θ_{JA}, and the ambient temperature, T_A. The maximum allowable power dissipation at any ambient temperature is calculated using: P_{D(max)} = (T_{J(max)} - T_A) / θ_{JA}. Exceeding the maximum allowable power dissipation will result in excessive die temperature, and the regulator will go into thermal shutdown. See Table 1 and the "Thermal Considerations" section for details.
- Output voltage temperature coefficient is defined as the worst case voltage change divided by the total temperature range.
- Regulation is measured at constant junction temperature using low duty cycle pulse testing. Parts are tested for load regulation in the load range from 100mA to 500mA. Changes in output voltage due to heating effects are covered by the thermal regulation specification.
- Dropout voltage is defined as the input to output differential at which the output voltage drops 2% below its nominal value measured at 1V differential.
- Ground pin current is the regulator quiescent current plus pass transistor base current. The total current drawn from the supply is the sum of the load current plus the ground pin current.
- V_{EN} is the voltage externally applied to devices with the EN (enable) input pin.
- Thermal regulation is defined as the change in output voltage at a time "t" after a change in power dissipation is applied, excluding load or line regulation effects. Specifications are for a 500mA load pulse at V_{IN} = 12V for t = 10ms.
- The error flag comparator includes 3% hysteresis.

Typical Characteristics

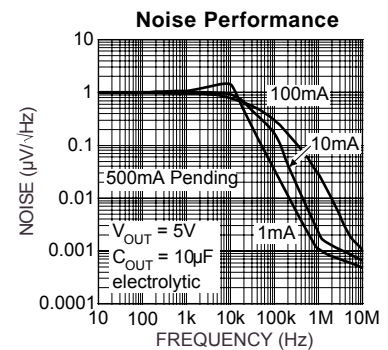
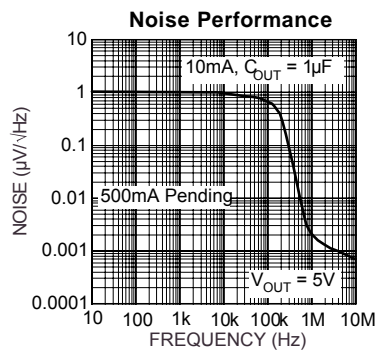
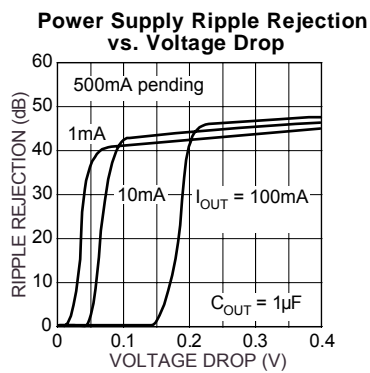
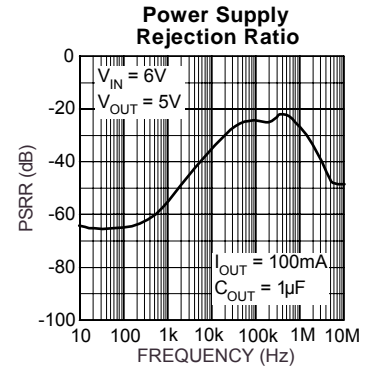
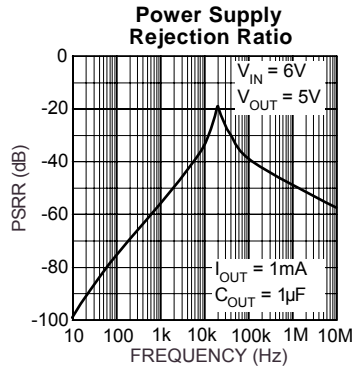
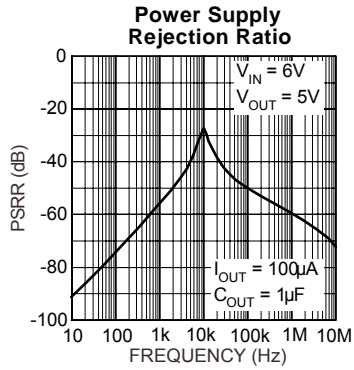

Block Diagram

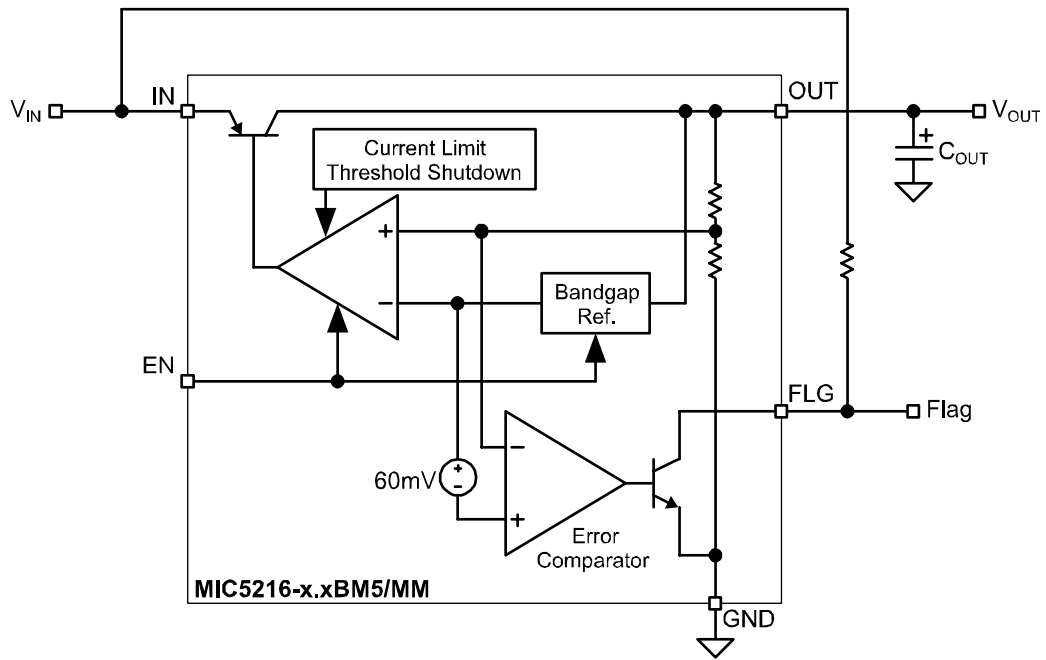

MIC5216 Fixed Regulator with External Components

Application Information

The MIC5216 is designed for 150mA to 200mA output current applications where a high current spike (500mA) is needed for short, startup conditions. Basic application of the device will be discussed initially followed by a more detailed discussion of higher current applications.

Enable/Shutdown

Forcing EN (enable/shutdown) high (> 2V) enables the regulator. EN is compatible with CMOS logic. If the enable/shutdown feature is not required, connect EN to IN (supply input). See Figure 5.

Input Capacitor

A 1μF capacitor should be placed from IN to GND if there is more than 10 inches of wire between the input and the ac filter capacitor or if a battery is used as the input.

Output Capacitor

An output capacitor is required between OUT and GND to prevent oscillation. 1μF minimum is recommended. Larger values improve the regulator's transient response. The output capacitor value may be increased without limit.

The output capacitor should have an ESR (equivalent series resistance) of about 5Ω or less and a resonant frequency above 1MHz. Ultralow-ESR capacitors could cause oscillation and/or underdamped transient response. Most tantalum or aluminum electrolytic capacitors are adequate; film types will work, but more expensive. Many aluminum electrolytics have electrolytes that freeze at about -30°C, so solid tantalums are recommended for operation below -25°C.

At lower values of output current, less output capacitance is needed for stability. The capacitor can be reduced to 0.47μF for current below 10mA or 0.33μF for currents below 1mA.

No-Load Stability

The MIC5216 will remain stable and in regulation with no load (other than the internal voltage divider) unlike many other voltage regulators. This is especially important in CMOS RAM keep-alive applications.

Error Flag Output

The error flag is an open-collector output and is active (low) when an undervoltage of approximately 5% below the nominal output voltage is detected. A pull-up resistor from IN to FLAG is shown in all schematics.

If an error indication is not required, FLAG may be left open and the pull-up resistor may be omitted.

Thermal Considerations

The MIC5216 is designed to provide 200mA of continuous current in two very small profile packages. Maximum power dissipation can be calculated based on the output current and the voltage drop across the part. To determine the maximum power dissipation of the package, use the thermal resistance, junction-to-ambient, of the device and the following basic equation.

$$P_{D(MAX)} = \frac{(T_{J(MAX)} - T_A)}{\theta_{JA}}$$

$T_{J(MAX)}$ is the maximum junction temperature of the die, 125°C, and T_A is the ambient operating temperature. θ_{JA} is layout dependent; table 1 shows examples of thermal resistance, junction-to-ambient, for the MIC5216.

Package	θ_{JA} Recommended Minimum Footprint	θ_{JA} 1" Square Copper Clad	θ_{JC}
MM8™ (MM)	160°C/W	70°C/W	30°C/W
SOT-23-5 (M5)	220°C/W	170°C/W	130°C/W

Table 1. MIC5216 Thermal Resistance

The actual power dissipation of the regulator circuit can be determined using one simple equation.

$$P_D = (V_{IN} - V_{OUT}) I_{OUT} + V_{IN} I_{GND}$$

Substituting $P_{D(MAX)}$ for P_D and solving for the operating conditions that are critical to the application will give the maximum operating conditions for the regulator circuit. For example, if we are operating the MIC5216-3.3BM5 at room temperature, with a minimum footprint layout, we can determine the maximum input voltage for a set output current.

$$P_{D(MAX)} = \frac{(125^\circ\text{C} - 25^\circ\text{C})}{220^\circ\text{C/W}}$$

$$P_{D(MAX)} = 455\text{mW}$$

The thermal resistance, junction-to-ambient, for the minimum footprint is 220°C/W, taken from table 1. The maximum power dissipation number cannot be exceeded for proper operation of the device. Using the output voltage of 3.3V, and an output current of 150mA, we can determine the maximum input voltage. Ground current, maximum of 3mA for 150mA of output current, can be taken from the Electrical Characteristics section of the data sheet.

$$455\text{mW} = (V_{IN} - 3.3\text{V}) 150\text{mA} + V_{IN} \times 3\text{mA}$$

$$V_{IN} \left(\frac{455\text{mW} + 3.3\text{V}(150\text{mA})}{150\text{mA} + 3\text{mA}} \right)$$

$$V_{IN} = 6.2V_{MAX}$$

Therefore, a 3.3V application at 150mA of output current can accept a maximum input voltage of 6.2V in a SOT-23-5 package. For a full discussion of heat sinking and thermal effects on voltage regulators, refer to the Regulator Thermals section of Micrel's *Designing with Low-Dropout Voltage Regulators* handbook.

Peak Current Applications

The MIC5216 is designed for applications where high start-up currents are demanded from space constrained regulators. This device will deliver 500mA start-up current from a SOT-23-5 or MM8 package, allowing high power from a very low profile device. The MIC5216 can subsequently provide output current that is only limited by the thermal characteristics of the device. You can obtain higher continuous currents from the device with the proper design. This is easily proved with some thermal calculations.

If we look at a specific example, it may be easier to follow. The MIC5216 can be used to provide up to 500mA continuous output current. First, calculate the maximum power dissipation of the device, as was done in the thermal considerations section. Worst case thermal resistance ($\theta_{JA} = 220^{\circ}\text{C}/\text{W}$ for the MIC5216-x.xBM5), will be used for this example.

$$P_{D(MAX)} = \frac{(T_{J(MAX)} - T_A)}{\theta_{JA}}$$

Assuming room temperature, we have a maximum power dissipation number of

$$P_{D(MAX)} = \frac{(125^{\circ}\text{C} - 25^{\circ}\text{C})}{220^{\circ}\text{C}/\text{W}}$$

$$P_{D(MAX)} = 455\text{mW}$$

Then we can determine the maximum input voltage for a five-volt regulator operating at 500mA, using worst case ground current.

$$P_{D(MAX)} = 455\text{mW} = (V_{IN} - V_{OUT}) I_{OUT} + V_{IN} I_{GND}$$

$$I_{OUT} = 500\text{mA}$$

$$V_{OUT} = 5\text{V}$$

$$I_{GND} = 20\text{mA}$$

$$455\text{mW} = (V_{IN} - 5\text{V}) 500\text{mA} + V_{IN} \times 20\text{mA}$$

$$2.995\text{mW} = 520\text{mA} \times V_{IN}$$

$$V_{IN(MAX)} = \frac{2.995\text{W}}{520\text{mA}} = 5.683\text{V}$$

Therefore, to be able to obtain a constant 500mA output current from the 5216-5.0BM5 at room temperature, you need extremely tight input-output voltage differential, barely above the maximum dropout voltage for that current rating.

You can run the part from larger supply voltages if the proper precautions are taken. Varying the duty cycle using the enable pin can increase the power dissipation of the device by maintaining a lower average power figure. This is ideal for applications where high current is only needed in short bursts. Figure 1 shows the safe operating regions for the MIC5216-x.xBM5 at three different ambient temperatures and at different output currents. The data used to determine this figure assumed a minimum footprint PCB design for minimum heat sinking. Figure 2 incorporates the same factors as the first figure, but assumes a much better heat sink. A 1" square copper trace on the PC board reduces the thermal resistance of the device. This improved thermal resistance improves power dissipation and allows for a larger safe operating region.

Figures 3 and 4 show, safe operating regions for the MIC5216-x.xBMM, the power MSOP package part. These graphs show three typical operating regions at different temperatures. The lower the temperature, the larger the operating region. The graphs were obtained in a similar way to the graphs for the MIC5216-x.xBM5, taking all factors into consideration and using two different board layouts, minimum footprint and 1" square copper PC board heat sink. (For further discussion of PC board heat sink characteristics, refer to Application Hint 17, "Designing PC Board Heat Sinks".

The information used to determine the safe operating regions can be obtained in a similar manner to that used in determining typical power dissipation, already discussed. Determining the maximum power dissipation based on the layout is the first step, this is done in the same manner as in the previous two sections. Then, a larger power dissipation number multiplied by a set maximum duty cycle would give that maximum power dissipation number for the layout. This is best shown through an example. If the application calls for 5V at 500mA for short pulses, but the only supply voltage available is 8V, then the duty cycle has to be adjusted to determine an average power that does not exceed the maximum power dissipation for the layout.

$$\text{Avg. } P_D = \left(\frac{\%DC}{100} \right) (V_{IN} - V_{OUT}) I_{OUT} + V_{IN} I_{GND}$$

$$455\text{mW} = \left(\frac{\%DC}{100} \right) (8\text{V} - 5\text{V}) 500\text{mA} + 8\text{V} \times 20\text{mA}$$

$$455\text{mW} = \left(\frac{\% \text{Duty Cycle}}{100}\right) 1.66\text{W}$$

$$0.274 = \left(\frac{\% \text{Duty Cycle}}{100}\right)$$

% Duty Cycle Max = 27.4%

With an output current of 500mA and a three-volt drop across the MIC5216-xxBMM, the maximum duty cycle is 27.4%.

Applications also call for a set nominal current output with a greater amount of current needed for short durations. This is a tricky situation, but it is easily remedied. Calculate the average power dissipation for each current section, then add the two numbers giving the total power dissipation for the regulator. For example, if the regulator is operating normally at 50mA, but for 12.5% of the time it operates at 500mA output, the total power dissipation of the part can be easily determined. First, calculate the power dissipation of the device at 50mA. We will use the MIC5216-3.3BM5 with 5V input voltage as our example.

$$P_D \times 50\text{mA} = (5\text{V} - 3.3\text{V}) \times 50\text{mA} + 5\text{V} \times 650\mu\text{A}$$

$$P_D \times 50\text{mA} = 173\text{mW}$$

However, this is continuous power dissipation, the actual on-time for the device at 50mA is (100%-12.5%) or 87.5% of the time, or 87.5% duty cycle. Therefore, P_D must be multiplied by the duty cycle to obtain the actual average power dissipation at 50mA.

$$P_D \times 50\text{mA} = 0.875 \times 173\text{mW}$$

$$P_D \times 50\text{mA} = 151\text{mW}$$

The power dissipation at 500mA must also be calculated.

$$P_D \times 500\text{mA} = (5\text{V} - 3.3\text{V}) 500\text{mA} + 5\text{V} \times 20\text{mA}$$

$$P_D \times 500\text{mA} = 950\text{mW}$$

This number must be multiplied by the duty cycle at which it would be operating, 12.5%.

$$P_D \times = 0.125\text{mA} \times 950\text{mW}$$

$$P_D \times = 119\text{mW}$$

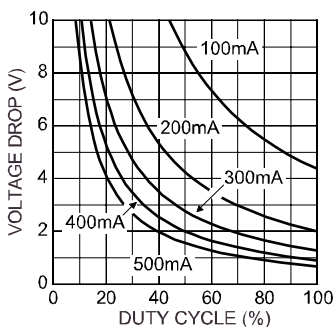

a. 25°C Ambient

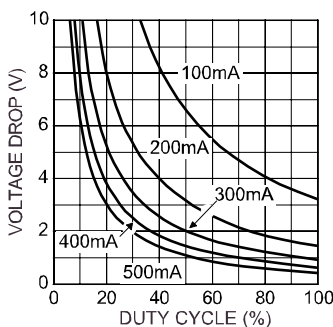

b. 50°C Ambient

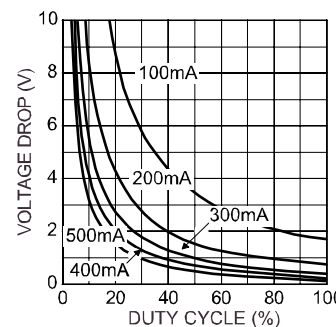

c. 85°C Ambient

Figure 1. MIC5216-x.xBM5 (SOT-23-5) on Minimum Recommended Footprint

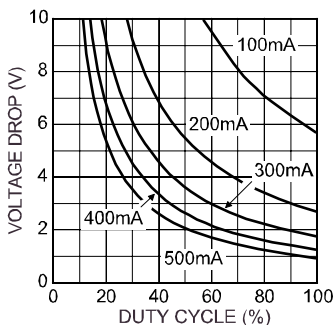

a. 25°C Ambient

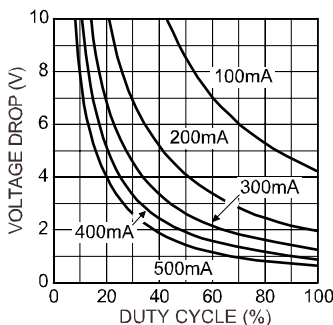

b. 50°C Ambient

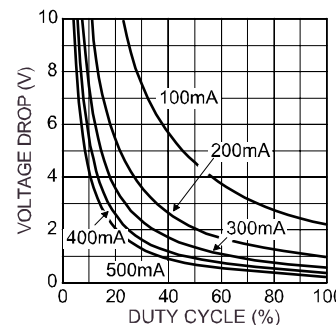

c. 85°C Ambient

Figure 2. MIC5216-x.xBM5 (SOT-23-5) on 1-inch² Copper Cladding

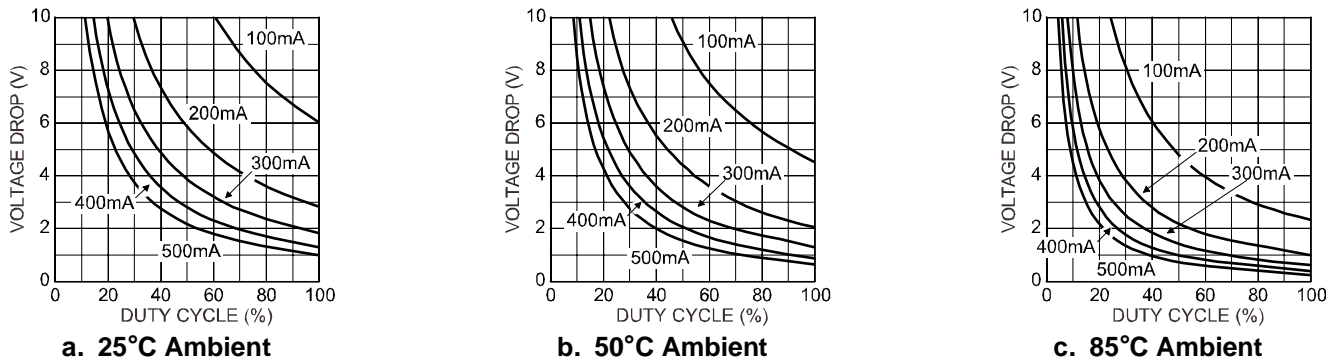

Figure 3. MIC5216-x.xBMM (MSOP-8) on Minimum Recommended Footprint

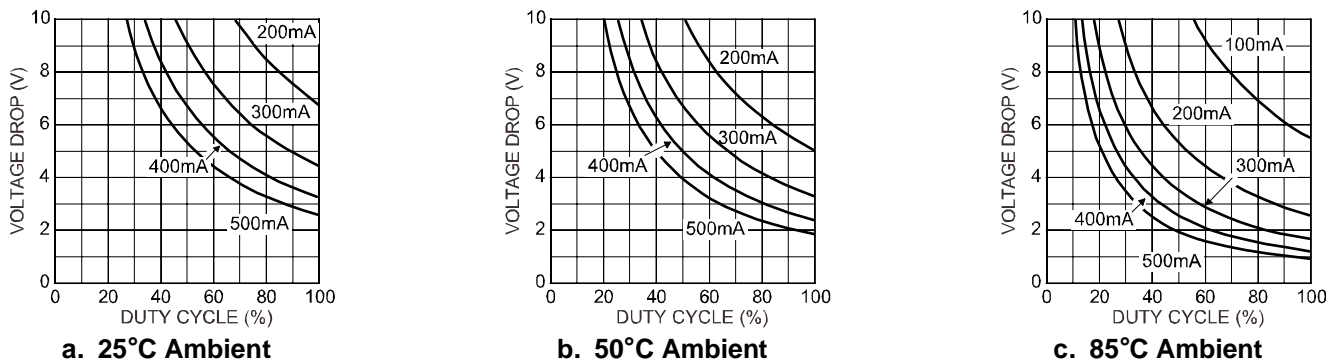

Figure 4. MIC5216-x.xBMM (MSOP-8) on 1-inch² Copper Cladding

The total power dissipation of the device under these conditions is the sum of the two power dissipation figures.

$$P_{D(\text{total})} = P_D \times 50\text{mA} + P_D \times 500\text{mA}$$

$$P_{D(\text{total})} = 151\text{mW} + 119\text{mW}$$

$$P_{D(\text{total})} = 270\text{mW}$$

The total power dissipation of the regulator is less than the maximum power dissipation of the SOT-23-5 package at room temperature, on a minimum footprint board and therefore would operate properly.

Multilayer boards with a ground plane, wide traces near the pads, and large supply-bus lines will have better thermal conductivity.

For additional heat sink characteristics, please refer to Micrel Application Hint 17, "Designing P.C. Board Heat Sinks", included in Micrel's Databook. For a full discussion of heat sinking and thermal effects on voltage regulators, refer to Regulator Thermals section of Micrel's *Designing with Low-Dropout Voltage Regulators* handbook.

Fixed Regulator Circuits

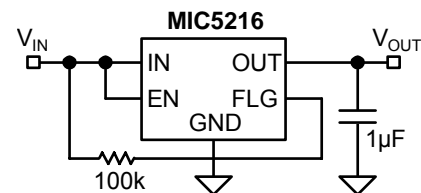
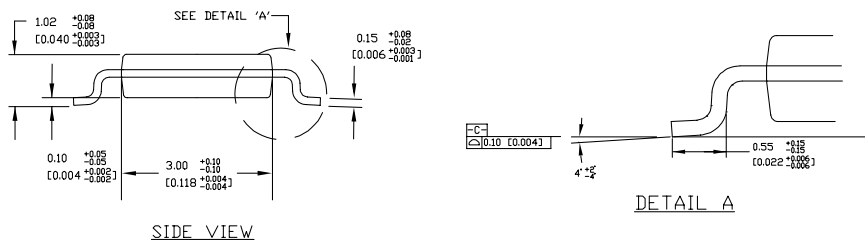
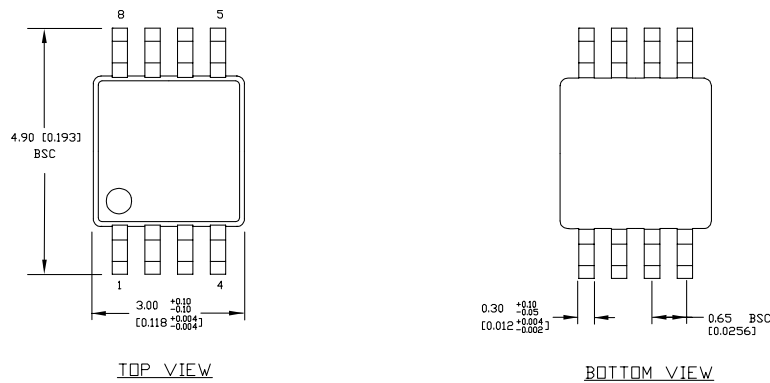

Figure 5. Low-Noise Fixed Voltage Regulator

Figure 5 shows a basic MIC5216-x.xBm_x fixed-voltage regulator circuit. A 1µF minimum output capacitor is required for basic fixed-voltage applications.

The flag output is an open-collector output and requires a pull-up resistor to the input voltage. The flag indicates an undervoltage condition on the output of the device.

Package Information



- NOTES:
1. DIMENSIONS ARE IN MM [INCHES].
 2. CONTROLLING DIMENSION: MM
 3. DIMENSION DOES NOT INCLUDE MOLD FLASH OR PROTRUSIONS, EITHER OF WHICH SHALL NOT EXCEED 0.20 [0.008] PER SIDE.

8-Pin MSOP (MM)

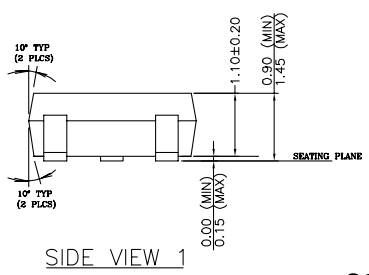
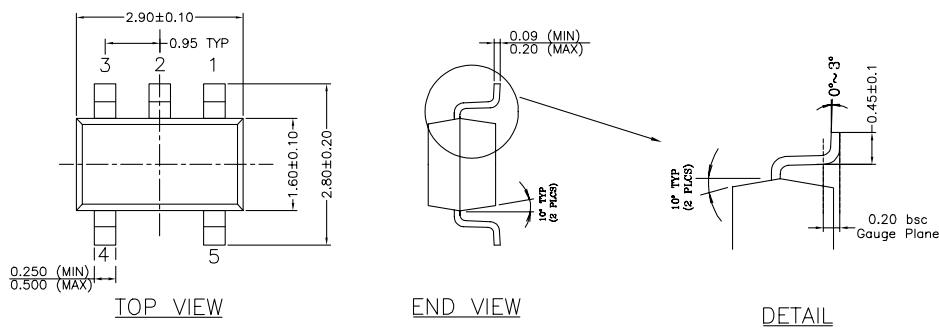

- NOTE:
1. PACKAGE OUTLINE EXCLUSIVE OF MOLD FLASH & BURR.
 2. PACKAGE OUTLINE INCLUSIVE OF SOLER PLATING.
 3. DIMENSION AND TOLERANCE PER ANSI Y14.5M, 1982.
 4. FOOT LENGTH MEASUREMENT BASED ON GAUGE PLANE METHOD.
 5. DIE FACES UP FOR MOLD, AND FACES DOWN FOR TRIM/FORM.

SOT-23-5 (M5)

MICREL, INC. 2180 FORTUNE DRIVE SAN JOSE, CA 95131 USA
TEL +1 (408) 944-0800 FAX +1 (408) 474-1000 WEB <http://www.micrel.com>

The information furnished by Micrel in this data sheet is believed to be accurate and reliable. However, no responsibility is assumed by Micrel for its use. Micrel reserves the right to change circuitry and specifications at any time without notification to the customer.

Micrel Products are not designed or authorized for use as components in life support appliances, devices or systems where malfunction of a product can reasonably be expected to result in personal injury. Life support devices or systems are devices or systems that (a) are intended for surgical implant into the body or (b) support or sustain life, and whose failure to perform can be reasonably expected to result in a significant injury to the user. A Purchaser's use or sale of Micrel Products for use in life support appliances, devices or systems is a Purchaser's own risk and Purchaser agrees to fully indemnify Micrel for any damages resulting from such use or sale.

© 2000 Micrel, Incorporated.

Looking for pricing, stock, or lifecycle information?

Click below to explore more details on WIN SOURCE:

 [View MIC5216-3.6YM5-TR on WIN SOURCE](#)

 [Microchip Technology](#) Information

Optimize Your Supply Chain with WIN SOURCE Solutions

-  Global Sourcing Solution
-  Obsolete Management
-  Cost Control Management
-  Shortage Management
-  Alternative Solution
-  Excess Inventory Management