



MIC5318

High Performance 300mA
 μ Cap ULDO™

General Description

The MIC5318 is a high performance, single output ultra low drop-out (ULDO™) regulator, offering low total output noise in an ultra-small Thin MLF® package. The MIC5318 is capable of sourcing 300mA output current and offers high PSRR and low output noise, making it an ideal solution for RF applications.

Ideal for battery operated applications, the MIC5318 offers 2% initial accuracy, extremely low dropout voltage (110mV @ 300mA), and low ground current (typically 85 μ A total). The MIC5318 can also be put into a zero-off-mode current state, drawing no current when disabled.

The MIC5318 is available in the 1.6mm x 1.6mm Thin MLF® package, occupying only 2.56mm² of PCB area, fully a 36% reduction in board area when compared to SC-70 and 2mm x 2mm MLF® packages.

The MIC5318 has an operating junction temperature range of -40°C to +125°C and is available in fixed and adjustable output voltages in lead-free (RoHS compliant) Thin MLF® and Thin SOT23-5 packages.

Data sheets and support documentation can be found on Micrel's web site at: www.micrel.com.

Features

- Ultra low dropout voltage 110mV @ 300mA
- Input voltage range: 2.3V to 6.0V
- 300mA guaranteed output current
- Stable with ceramic output capacitors
- Ultra low output noise – 30 μ Vrms
- Low quiescent current – 85 μ A total
- High PSRR > 70dB@1kHz
- Less than 35 μ s turn-on time
- High output accuracy
 - \pm 2% initial accuracy
 - \pm 3% over temperature
- Thermal shutdown and current limit protection
- Tiny 6-pin 1.6mm x 1.6mm Thin MLF® package
- Thin SOT23-5 package

Applications

- Mobile phones
- PDAs
- GPS receivers
- Portable electronics
- Digital still and video cameras

Typical Application

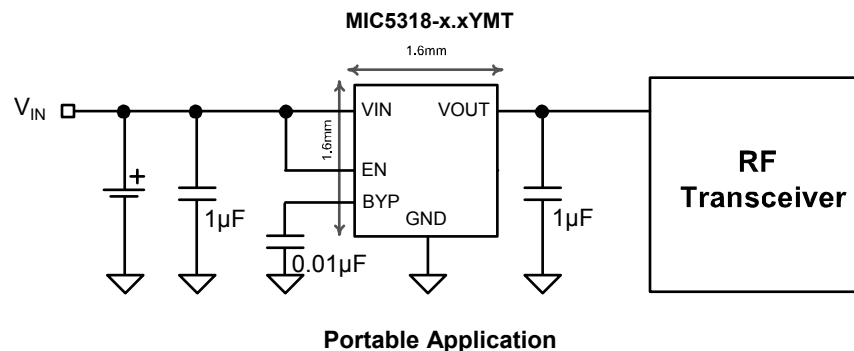

ULDO is a trademark of Micrel, Inc.

MLF and *MicroLeadFrame* are registered trademarks of Amkor Technology, Inc.

Micrel Inc. • 2180 Fortune Drive • San Jose, CA 95131 • USA • tel +1 (408) 944-0800 • fax + 1 (408) 474-1000 • <http://www.micrel.com>

Functional Diagram

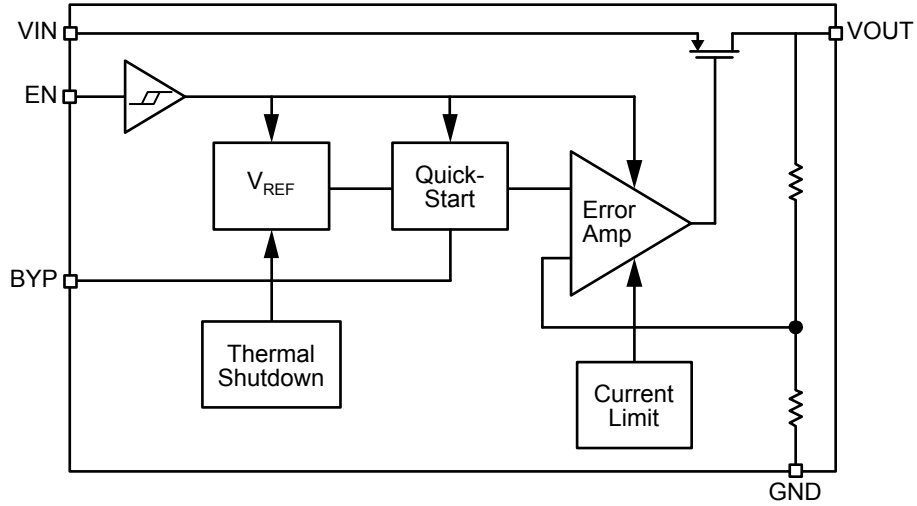

MIC5318 Block Diagram – Fixed

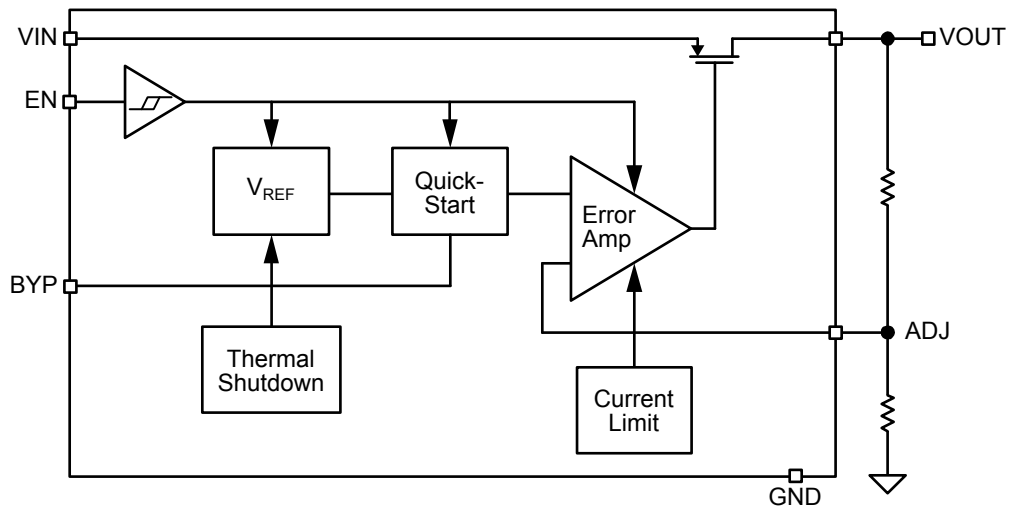

MIC5318 Block Diagram – Adjustable

Ordering Information

Part Number	Marking Code	Output Voltage	Temperature Range	Package
MIC5318-1.5YMT	15D	1.5V	-40°C to +125°C	6-Pin 1.6 x 1.6 Thin MLF [®]
MIC5318-1.8YMT	18D	1.8V	-40°C to +125°C	6-Pin 1.6 x 1.6 Thin MLF [®]
MIC5318-2.5YMT	25D	2.5V	-40°C to +125°C	6-Pin 1.6 x 1.6 Thin MLF [®]
MIC5318-2.8YMT	28D	2.8V	-40°C to +125°C	6-Pin 1.6 x 1.6 Thin MLF [®]
MIC5318-3.3YMT	33D	3.3V	-40°C to +125°C	6-Pin 1.6 x 1.6 Thin MLF [®]
MIC5318YMT	DAA	ADJ	-40°C to +125°C	6-Pin 1.6 x 1.6 Thin MLF [®]
MIC5318-1.5YD5	<u>QD</u> 15	1.5V	-40°C to +125°C	5-Pin Thin SOT23
MIC5318-1.8YD5	<u>QD</u> 18	1.8V	-40°C to +125°C	5-Pin Thin SOT23
MIC5318-2.5YD5	<u>QD</u> 25	2.5V	-40°C to +125°C	5-Pin Thin SOT23
MIC5318-2.8YD5	<u>QD</u> 28	2.8V	-40°C to +125°C	5-Pin Thin SOT23
MIC5318-3.3YD5	<u>QD</u> 33	3.3V	-40°C to +125°C	5-Pin Thin SOT23
MIC5318YD5	<u>QD</u> A	ADJ	-40°C to +125°C	5-Pin Thin SOT23

Note:

1. For availability on other voltages, please contact Micrel for details.

Pin Configuration

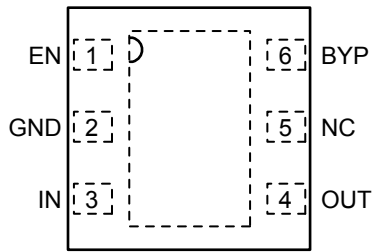

**6-Pin 1.6mm x 1.6mm Thin MLF[®] (MT)
Fixed (Top View)**

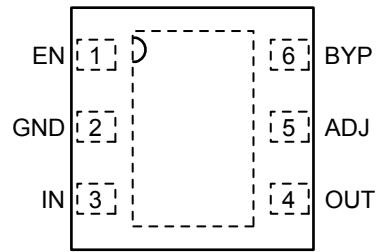

**6-Pin 1.6mm x 1.6mm Thin MLF[®] (MT)
Adjustable (Top View)**

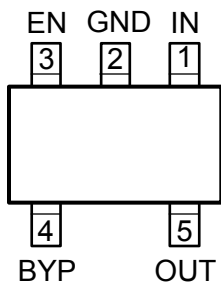

**5-Pin Thin SOT23 (D5)
Fixed (Top View)**

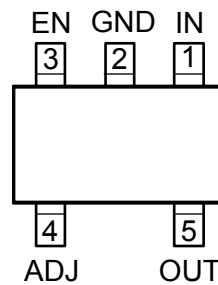

**5-Pin Thin SOT23 (D5)
Adjustable (Top View)**

Pin Description

Pin No. Thin MLF-6 Fixed	Pin No. Thin MLF-6 Adj.	Pin No. Thin SOT23-5 Fixed	Pin No. Thin SOT23-5 Adj.	Pin Name	Pin Function
1	1	3	3	EN	Enable Input. Active High. High = on, low = off. Do not leave floating.
2	2	2	2	GND	Ground
3	3	1	1	IN	Supply Input.
4	4	5	5	OUT	Output Voltage.
5	–	–	–	NC	No connection.
–	5	–	4	ADJ	Adjust Input. Connect to external resistor voltage divider network.
6	6	4	–	BYP	Reference Bypass: Connect external 0.01 μ F to GND for reduced Output Noise. May be left open.
HS Pad	HS Pad	–	–	E PAD	Exposed Heatsink Pad connected to ground internally.

Absolute Maximum Ratings⁽¹⁾

Supply Voltage (V_{IN}).....	0V to +6.5V
Enable Input Voltage (V_{EN}).....	0V to +6.5V
Power Dissipation, Internally Limited ⁽³⁾	
Lead Temperature (soldering, 3sec).....	260°C
Junction Temperature (T_J).....	-40°C to +125°C
Storage Temperature (T_S).....	-65°C to +150°C
ESD Rating ⁽⁴⁾	

Operating Ratings⁽²⁾

Supply Voltage (V_{IN}).....	+2.3V to +6.0V
Enable Input Voltage (V_{EN}).....	0V to V_{IN}
Junction Temperature (T_J).....	-40°C to +125°C
Junction Thermal Resistance	
Thin MLF-6 (θ_{JA}).....	100°C/W
TSOT-23-5 (θ_{JA}).....	235°C/W

Electrical Characteristics⁽⁵⁾

$V_{IN} = V_{OUT} + 1.0V$; $C_{OUT} = 1.0\mu F$; $I_{OUT} = 100\mu A$; $T_J = 25^\circ C$, **bold** values indicate -40°C to +125°C, unless noted.

Parameter	Conditions	Min	Typ	Max	Units
Output Voltage Accuracy	Variation from nominal V_{OUT}	-2.0		+2.0	%
	Variation from nominal V_{OUT} ; -40°C to +125°C	-3.0		+3.0	%
Line Regulation	$V_{IN} = V_{OUT} + 1V$ to 6.0V; $I_{OUT} = 100\mu A$		0.02	0.6	%/V
Load Regulation, Note 6	$I_{OUT} = 100\mu A$ to 300mA		0.2	2.0	%
Dropout Voltage, Note 7	$I_{OUT} = 50mA$; $V_{OUT} \geq 2.8V$		17		mV
	$I_{OUT} = 150mA$; $V_{OUT} \geq 2.8V$		50	100	
	$I_{OUT} = 300mA$; $V_{OUT} \geq 2.8V$		110	200	
Ground Pin Current, Note 8	$I_{OUT} = 0$ to 300mA		85	150	μA
Ground Pin Current in Shutdown	$V_{EN} \leq 0.2V$		0.01	1	μA
Ripple Rejection	$f = \text{up to } 1kHz$; $C_{OUT} = 1.0\mu F$; $C_{BYP} = 0.1\mu F$		75		dB
	$f = 1kHz - 20kHz$; $C_{OUT} = 1.0\mu F$; $C_{BYP} = 0.1\mu F$		55		
Current Limit	$V_{OUT} = 0V$	340	500	900	mA
Output Voltage Noise	$C_{OUT} = 1.0\mu F$; $C_{BYP} = 0.1\mu F$; 10Hz to 100kHz		30		μV_{RMS}
Enable Input					
Enable Input Voltage	Logic Low			0.2	V
	Logic High	1.1			
Enable Input Current	$V_{IL} \leq 0.2V$		0.01	1	μA
	$V_{IH} \geq 1.0V$		0.01	1	
Turn-On Time					
Turn-On Time	$C_{OUT} = 1.0\mu F$; $C_{BYP} = 0.1\mu F$; $I_{OUT} = 150mA$		30	100	μs

Notes:

- Exceeding the absolute maximum rating may damage the device.
- The device is not guaranteed to function outside its operating rating.
- The maximum allowable power dissipation of any T_A (ambient temperature) is $P_{D(max)} = (T_{J(max)} - T_A) / \theta_{JA}$. Exceeding the maximum allowable power dissipation will result in excessive die temperature, and the regulator will go into thermal shutdown.
- Devices are ESD sensitive. Handling precautions recommended. Human body model.
- Specification for packaged product only.
- Regulation is measured at constant junction temperature using low duty cycle pulse testing, changes in output voltage due to heating effects are covered by the thermal regulation specification.
- Dropout voltage is defined as the input-to-output differential at which the output voltage drops 2% below its nominal value measured at 1V differential. For outputs below 2.3V, dropout voltage is the input-to-output differential with the minimum input voltage 2.3V.
- Ground pin current is the regulation quiescent current. The total current drawn from the supply is the sum of the load current plus the ground pin current.

Typical Characteristics

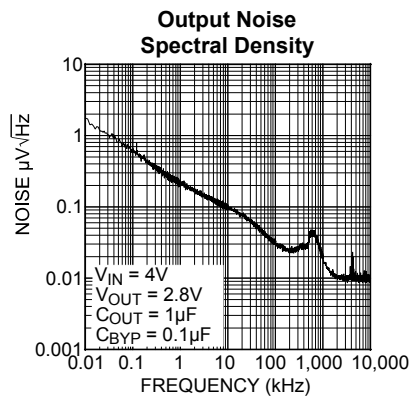
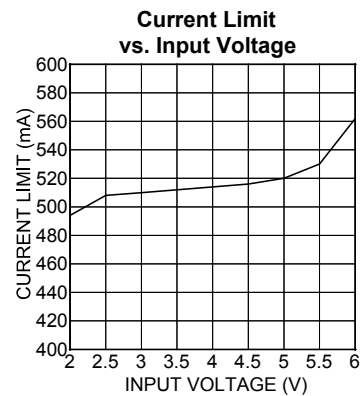
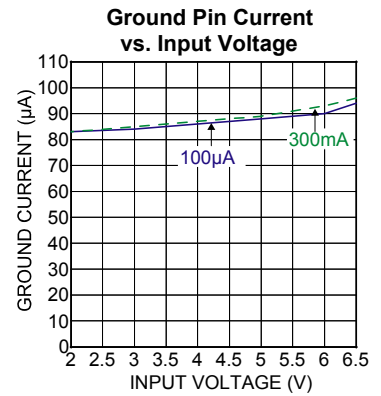
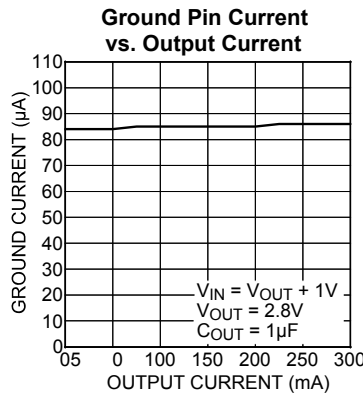
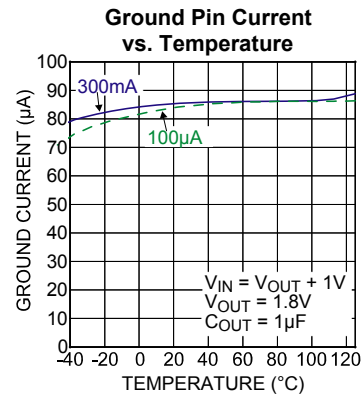
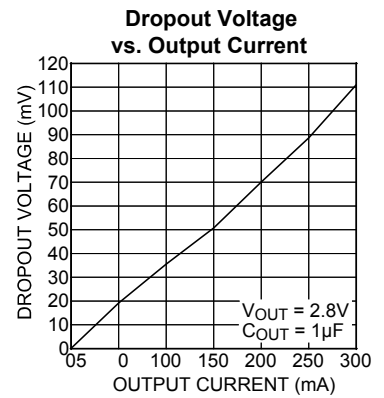
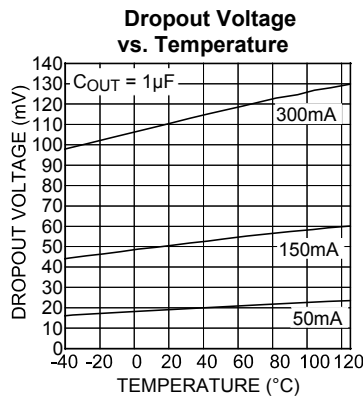
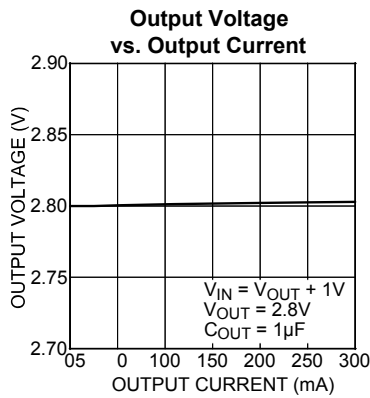
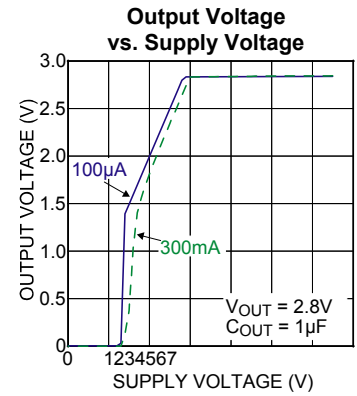
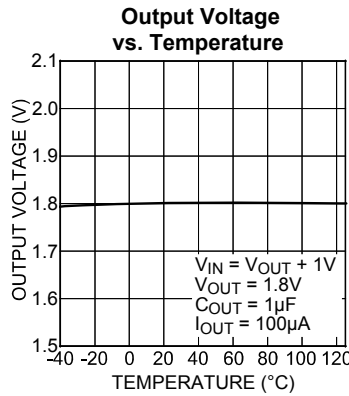
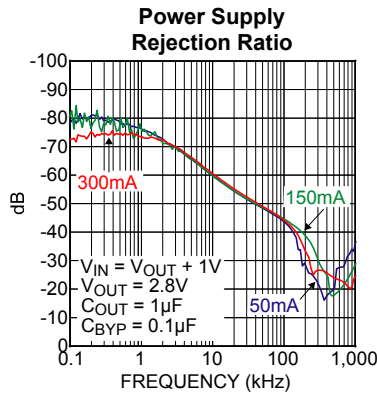

Functional Characteristics

Enable Turn-On

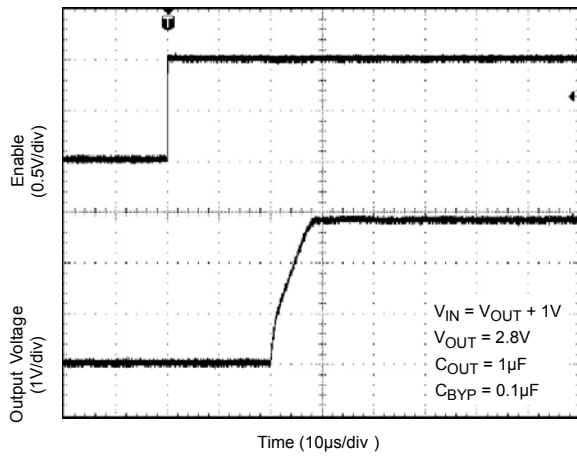

Line Transient

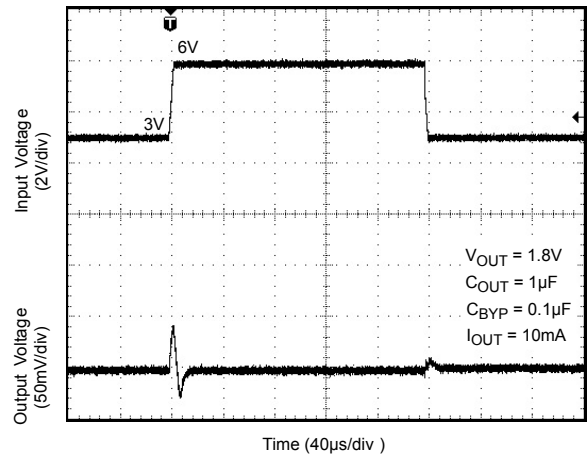

Load Transient

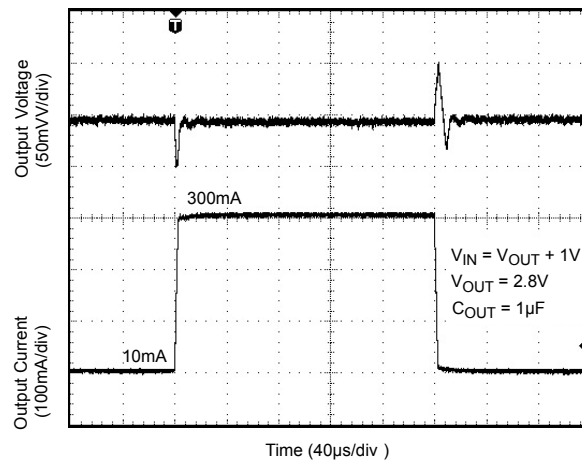

Application Information

Enable/Shutdown

The MIC5318 comes with an active-high enable pin that allows the regulator to be disabled. Forcing the enable pin low disables the regulator and sends it into a “zero” off-mode-current state. In this state, current consumed by the regulator goes nearly to zero. Forcing the enable pin high enables the output voltage. The active-high enable pin uses CMOS technology and the enable pin cannot be left floating; a floating enable pin may cause an indeterminate state on the output.

Input Capacitor

The MIC5318 is a high-performance, high bandwidth device. Therefore, it requires a well-bypassed input supply for optimal performance. A 1 μ F capacitor is required from the input to ground to provide stability. Low-ESR ceramic capacitors provide optimal performance at a minimum of space. Additional high-frequency capacitors, such as small-valued NPO dielectric-type capacitors, help filter out high-frequency noise and are good practice in any RF-based circuit.

Output Capacitor

The MIC5318 requires an output capacitor of 1 μ F or greater to maintain stability. The design is optimized for use with low-ESR ceramic chip capacitors. High ESR capacitors may cause high frequency oscillation. The output capacitor can be increased, but performance has been optimized for a 1 μ F ceramic output capacitor and does not improve significantly with larger capacitance.

X7R/X5R dielectric-type ceramic capacitors are recommended because of their temperature performance. X7R-type capacitors change capacitance by 15% over their operating temperature range and are the most stable type of ceramic capacitors. Z5U and Y5V dielectric capacitors change value by as much as 50% and 60%, respectively, over their operating temperature ranges. To use a ceramic chip capacitor with Y5V dielectric, the value must be much higher than an X7R ceramic capacitor to ensure the same minimum capacitance over the equivalent operating temperature range.

Bypass Capacitor

A capacitor can be placed from the noise bypass pin to ground to reduce output voltage noise. The capacitor bypasses the internal reference. A 0.1 μ F capacitor is recommended for applications that require low-noise outputs. The bypass capacitor can be increased, further reducing noise and improving PSRR. Turn-on time increases slightly with respect to bypass capacitance. A unique, quick-start circuit allows the MIC5318 to drive a large capacitor on the bypass pin without significantly slowing turn-on time. Refer to the *Typical Characteristics* subsection for performance with different bypass capacitors.

No-Load Stability

Unlike many other voltage regulators, the MIC5318 will remain stable and in regulation with no load. This is especially crucial for CMOS RAM keep-alive applications.

Adjustable Regulator Application

Adjustable regulators use the ratio of two resistors to multiply the reference voltage to produce the desired output voltage. The MIC5318 can be adjusted from 1.25V to 5.5V by using two external resistors (Figure 1). The resistors set the output voltage based on the following equation:

$$V_{OUT} = V_{REF} \left(1 + \frac{R1}{R2} \right)$$

$$V_{REF} = 1.25V$$

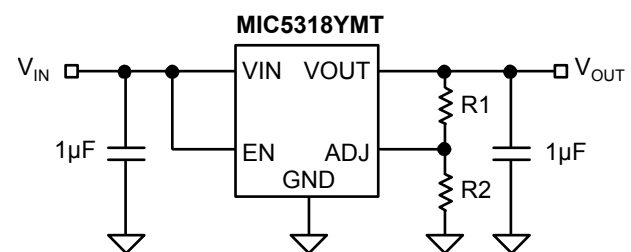

Figure 1. Adjustable Voltage Output

Thermal Considerations

The MIC5318 is designed to provide 300mA of continuous current. Maximum ambient operating temperature can be calculated based on the output current and the voltage drop across the part. Given that the input voltage is 3.3V, the output voltage is 2.8V and the output current = 300mA.

The actual power dissipation of the regulator circuit can be determined using the equation:

$$P_D = (V_{IN} - V_{OUT}) I_{OUT} + V_{IN} I_{GND}$$

Because this device is CMOS and the ground current is typically <100μA over the load range, the power dissipation contributed by the ground current is < 1% and can be ignored for this calculation:

$$P_D = (3.3V - 2.8V) \times 300mA$$

$$P_D = 0.15W$$

To determine the maximum ambient operating temperature of the package, use the junction-to-ambient thermal resistance of the device and the following basic equation:

$$P_{D(MAX)} = \left(\frac{T_{J(MAX)} - T_A}{\theta_{JA}} \right)$$

$T_{J(max)} = 125^\circ\text{C}$, the maximum junction temperature of the die θ_{JA} thermal resistance = 100°C/W .

The table below shows junction-to-ambient thermal resistance for the MIC5318 in the 6-pin 1.6mm x 1.6mm Thin MLF[®] package.

Package	θ_{JA} Recommended Minimum Footprint
6-Pin 1.6x1.6 Thin MLF [®]	100°C/W

Thermal Resistance

Substituting P_D for $P_{D(max)}$ and solving for the ambient operating temperature will give the maximum operating conditions for the regulator circuit. The junction-to-ambient thermal resistance for the minimum footprint is 100°C/W .

The maximum power dissipation must not be exceeded for proper operation.

For example, when operating the MIC5318-2.8YMT at an input voltage of 3.3V and 300mA load with a minimum footprint layout, the maximum ambient operating temperature T_A can be determined as follows:

$$0.15W = (125^\circ\text{C} - T_A)/(100^\circ\text{C/W})$$

$$T_A = 110^\circ\text{C}$$

Therefore, a 2.8V application with 300mA of output current can accept an ambient operating temperature of 110°C in a 1.6mm x 1.6mm Thin MLF[®] package. For a full discussion of heat sinking and thermal effects on voltage regulators, refer to the "Regulator Thermals" section of Micrel's *Designing with Low-Dropout Voltage Regulators* handbook. This information can be found on Micrel's website at:

http://www.micrel.com/PDF/other/LDOBk_ds.pdf

Package Information

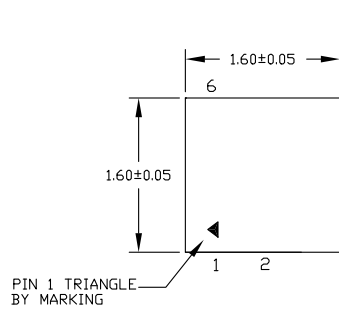

TOP VIEW

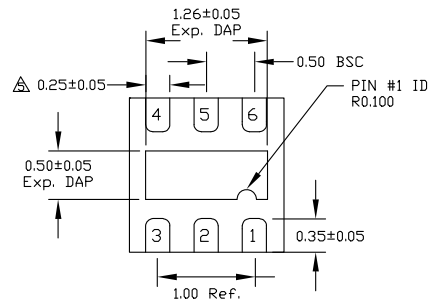

BOTTOM VIEW

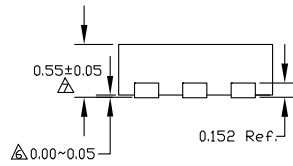

SIDE VIEW

- NOTE:
1. ALL DIMENSIONS ARE IN MILLIMETERS.
 2. MAX. PACKAGE WARPAGE IS 0.05 mm.
 3. MAXIMUM ALLDWADE BURRS IS 0.076 mm IN ALL DIRECTIONS.
 4. PIN #1 ID ON TOP WILL BE LASER/INK MARKED.
- △ DIMENSION APPLIES TO METALIZED TERMINAL AND IS MEASURED BETWEEN 0.20 AND 0.25 mm FROM TERMINAL TIP.
- △ APPLIED ONLY FOR TERMINALS.
- △ APPLIED FOR EXPOSED PAD AND TERMINALS.

6-Pin 1.6mm x 1.6mm Thin MLF® (MT)

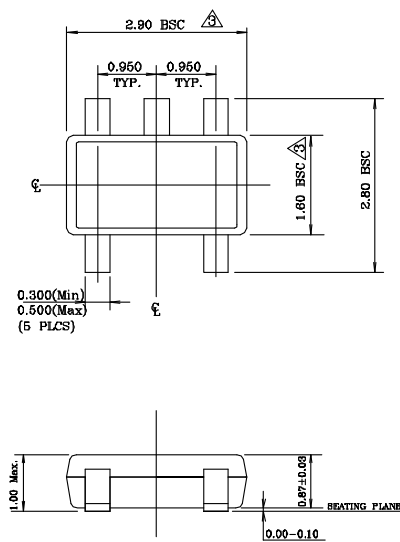

- NOTE:
1. Dimensions and tolerances are as per ANSI Y14.5M, 1994.
 2. Die is facing up for mold. Die is facing down for trim/form, i.e. reverse trim/form.
- △ Dimensions are exclusive of mold flash and gate burr.
4. The footlength measuring is based on the gauge plane method.
 5. All specification comply to Jedec Spec M0193 Issue C.
 6. All dimensions are in millimeters.

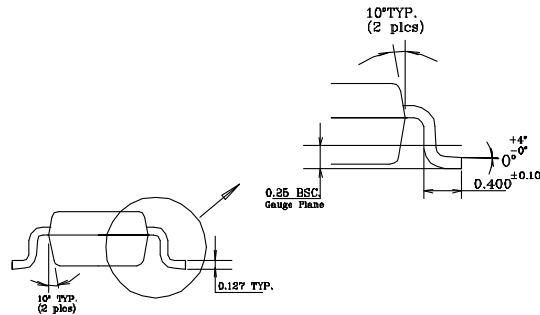

5-Pin TSOT-23 (D5)

MICREL, INC. 2180 FORTUNE DRIVE SAN JOSE, CA 95131 USATEL +1 (408) 944-0800 FAX +1 (408) 474-1000 WEB <http://www.micrel.com>

Micrel makes no representations or warranties with respect to the accuracy or completeness of the information furnished in this data sheet. This information is not intended as a warranty and Micrel does not assume responsibility for its use. Micrel reserves the right to change circuitry, specifications and descriptions at any time without notice. No license, whether express, implied, arising by estoppel or otherwise, to any intellectual property rights is granted by this document. Except as provided in Micrel's terms and conditions of sale for such products, Micrel assumes no liability whatsoever, and Micrel disclaims any express or implied warranty relating to the sale and/or use of Micrel products including liability or warranties relating to fitness for a particular purpose, merchantability, or infringement of any patent, copyright or other intellectual property right

Micrel Products are not designed or authorized for use as components in life support appliances, devices or systems where malfunction of a product can reasonably be expected to result in personal injury. Life support devices or systems are devices or systems that (a) are intended for surgical implant into the body or (b) support or sustain life, and whose failure to perform can be reasonably expected to result in a significant injury to the user. A Purchaser's use or sale of Micrel Products for use in life support appliances, devices or systems is a Purchaser's own risk and Purchaser agrees to fully indemnify Micrel for any damages resulting from such use or sale.

© 2006 Micrel, Incorporated.

Looking for pricing, stock, or lifecycle information?

Click below to explore more details on WIN SOURCE:

- ⊖ [View MIC5318-1.5YD5-TR on WIN SOURCE](#)
- ⊖ [Microchip Technology](#) Information

Optimize Your Supply Chain with WIN SOURCE Solutions

- ✓ Global Sourcing Solution
- ✓ Obsolete Management
- ✓ Cost Control Management
- ✓ Shortage Management
- ✓ Alternative Solution
- ✓ Excess Inventory Management