



Is Now Part of



**ON Semiconductor®**

To learn more about ON Semiconductor, please visit our website at  
[www.onsemi.com](http://www.onsemi.com)

Please note: As part of the Fairchild Semiconductor integration, some of the Fairchild orderable part numbers will need to change in order to meet ON Semiconductor's system requirements. Since the ON Semiconductor product management systems do not have the ability to manage part nomenclature that utilizes an underscore (\_), the underscore (\_) in the Fairchild part numbers will be changed to a dash (-). This document may contain device numbers with an underscore (\_). Please check the ON Semiconductor website to verify the updated device numbers. The most current and up-to-date ordering information can be found at [www.onsemi.com](http://www.onsemi.com). Please email any questions regarding the system integration to [Fairchild\\_questions@onsemi.com](mailto:Fairchild_questions@onsemi.com).

ON Semiconductor and the ON Semiconductor logo are trademarks of Semiconductor Components Industries, LLC dba ON Semiconductor or its subsidiaries in the United States and/or other countries. ON Semiconductor owns the rights to a number of patents, trademarks, copyrights, trade secrets, and other intellectual property. A listing of ON Semiconductor's product/patent coverage may be accessed at [www.onsemi.com/site/pdf/Patent-Marking.pdf](http://www.onsemi.com/site/pdf/Patent-Marking.pdf). ON Semiconductor reserves the right to make changes without further notice to any products herein. ON Semiconductor makes no warranty, representation or guarantee regarding the suitability of its products for any particular purpose, nor does ON Semiconductor assume any liability arising out of the application or use of any product or circuit, and specifically disclaims any and all liability, including without limitation special, consequential or incidental damages. Buyer is responsible for its products and applications using ON Semiconductor products, including compliance with all laws, regulations and safety requirements or standards, regardless of any support or applications information provided by ON Semiconductor. "Typical" parameters which may be provided in ON Semiconductor data sheets and/or specifications can and do vary in different applications and actual performance may vary over time. All operating parameters, including "Typicals" must be validated for each customer application by customer's technical experts. ON Semiconductor does not convey any license under its patent rights nor the rights of others. ON Semiconductor products are not designed, intended, or authorized for use as a critical component in life support systems or any FDA Class 3 medical devices or medical devices with a same or similar classification in a foreign jurisdiction or any devices intended for implantation in the human body. Should Buyer purchase or use ON Semiconductor products for any such unintended or unauthorized application, Buyer shall indemnify and hold ON Semiconductor and its officers, employees, subsidiaries, affiliates, and distributors harmless against all claims, costs, damages, and expenses, and reasonable attorney fees arising out of, directly or indirectly, any claim of personal injury or death associated with such unintended or unauthorized use, even if such claim alleges that ON Semiconductor was negligent regarding the design or manufacture of the part. ON Semiconductor is an Equal Opportunity/Affirmative Action Employer. This literature is subject to all applicable copyright laws and is not for resale in any manner.

# KA78RXXC-Series

## 1A Output Low Dropout Voltage Regulators

### Features

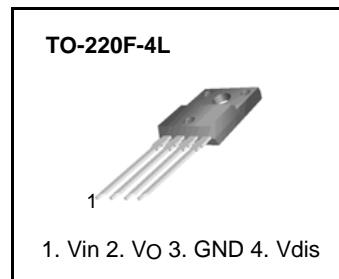
- 1A/3.3V, 5V, 8V, 9V, 12V, 15V output low dropout voltage regulator
- TO-220 full-mold package (4pin)
- Overcurrent protection, thermal shutdown
- Overvoltage protection, short circuit protection
- With output disable function

### Description

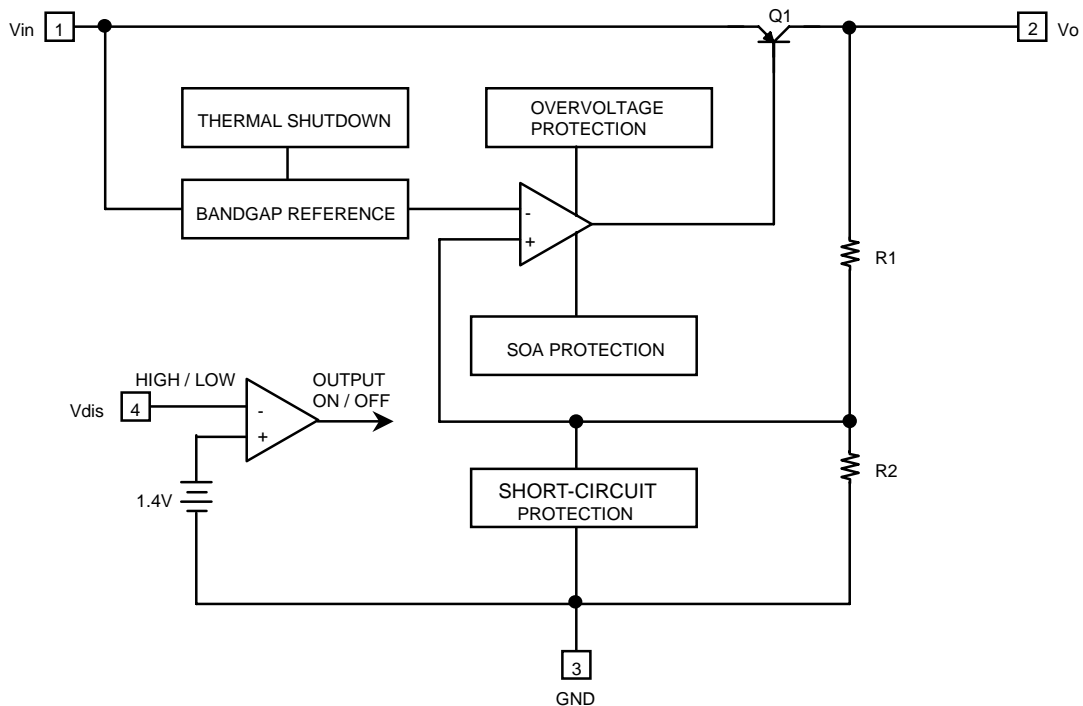
The KA78RXXC is a low-dropout voltage regulator suitable for various electronic equipments.

It provides constant voltage power source with TO-220-4 lead full mold package. Dropout voltage of KA78RXXC is below 0.5V in full rated current(1A).

This regulator has various functions such as peak current protection, thermal shut down, overvoltage protection and output disable function.



### Internal Block Diagram



---

## Absolute Maximum Ratings

### KA78RXXC

Parameter	Symbol	Value	Unit	Remark
Input voltage	V <sub>in</sub>	35	V	-
Disable voltage	V <sub>dis</sub>	35	V	-
Output current	I <sub>o</sub>	1.0	A	-
Power dissipation 1	P <sub>d1</sub>	1.5	W	No heatsink
Power dissipation 2	P <sub>d2</sub>	15	W	With heatsink
Junction temperature	T <sub>j</sub>	+150	°C	-
Operating temperature	T <sub>opr</sub>	-20 ~ +80	°C	-
Thermal resistance, junction-to case (Note2)	R <sub>θjc</sub>	4.31	°C/W	-
Thermal resistance, junction-to-air (Note2)	R <sub>θja</sub>	48.83	°C/W	-

## Electrical Characteristics

( $V_{in}$  = Note3,  $I_o$  = 0.5A,  $T_a$  = 25°C, unless otherwise specified)

Parameter	Symbol	Conditions	Min.	Typ.	Max.	Unit
Output voltage	KA78R33C	-	3.22	3.3	3.38	V
	KA78R05C	-	4.88	5	5.12	
	KA78R08C	-	7.8	8	8.2	
	KA78R09C	-	8.78	9	9.22	
	KA78R12C	-	11.7	12	12.3	
	KA78R15C	-	14.6	15	15.4	
Load regulation	Rload	5mA < $I_o$ < 1A	-	0.1	2.0	%
Line regulation	Rline	Note4	-	0.5	2.5	%
Ripple rejection ratio	RR	Note1	45	55	-	dB
Dropout voltage	Vdrop	$I_o$ = 1A	-	-	0.5	V
Disable voltage high	VdisH	Output active	2.0	-	-	V
Disable voltage low	VdisL	Output disabled	-	-	0.8	V
Disable bias current high	IdisH	Vdis = 2.7V	-	-	20	μA
Disable bias current low	IdisL	Vdis = 0.4V	-	-	-0.4	mA
Quiescent current	Iq	$I_o$ = 0A	-	-	10	mA

### Note:

- These parameters, although guaranteed, are not 100% tested in production.
- Junction -to -case thermal resistance test environments.
  - Pneumatic heat sink fixture.
  - Clamping pressure 60psi through 12mm diameter cylinder.
  - Thermal grease applied between PKG and heat sink fixture.
- KA78R33C :  $V_{in}$  = 5V  
 KA78R05C :  $V_{in}$  = 7V  
 KA78R08C :  $V_{in}$  = 10V  
 KA78R09C :  $V_{in}$  = 11V  
 KA78R12C :  $V_{in}$  = 15V  
 KA78R15C :  $V_{in}$  = 20V
- KA78R33C :  $V_{in}$  = 4V to 10V  
 KA78R05C :  $V_{in}$  = 6V to 12V  
 KA78R08C :  $V_{in}$  = 9V to 25V  
 KA78R09C :  $V_{in}$  = 10V to 25V  
 KA78R12C :  $V_{in}$  = 13V to 29V  
 KA78R15C :  $V_{in}$  = 16V to 30V

# Typical Performance Characteristics

## KA78R33

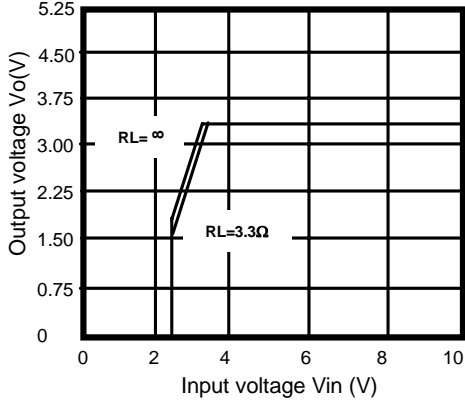


Figure 1. Output Voltage vs. Input Voltage

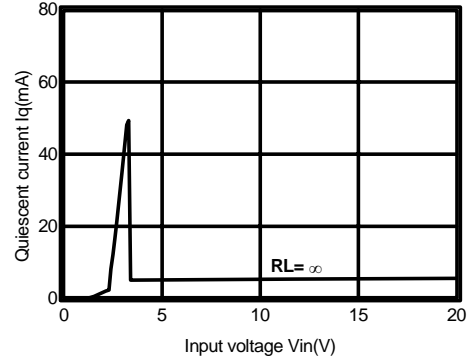


Figure 2. Quiescent Current vs. Input Voltage

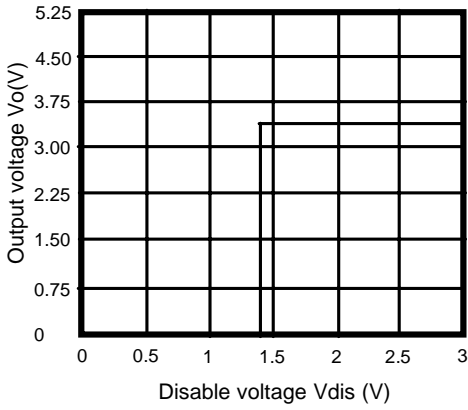


Figure 3. Output Voltage vs. Disable Voltage

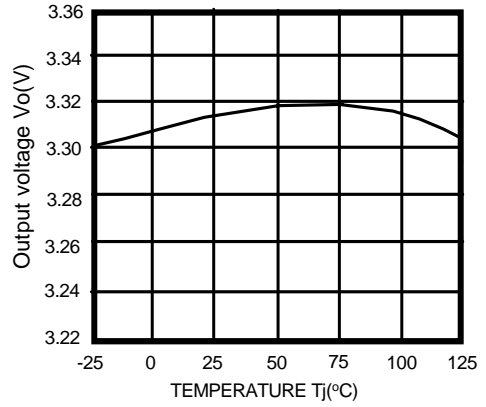


Figure 4. Output Voltage vs. Temperature(Tj)

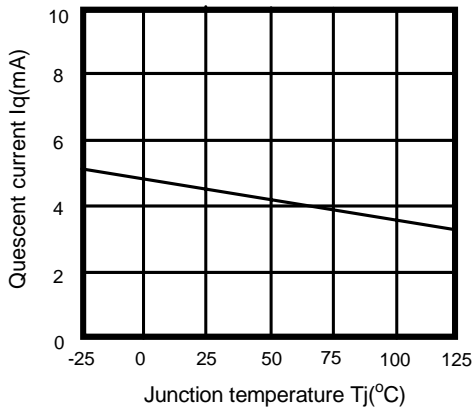


Figure 5. Quiescent Current vs. Temperature(Tj)

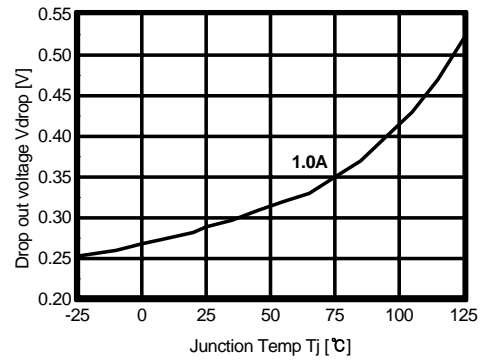
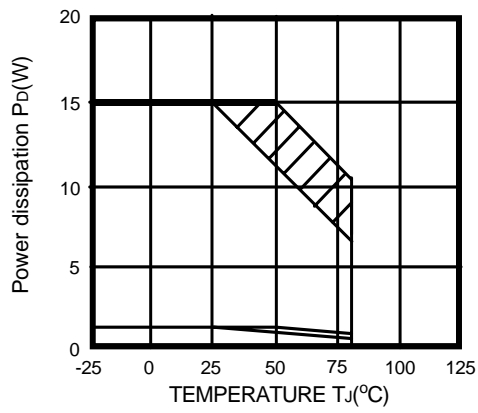
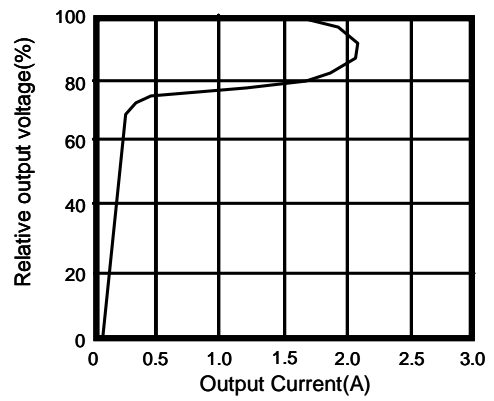


Figure 6. Dropout Voltage vs. Junction Temperature

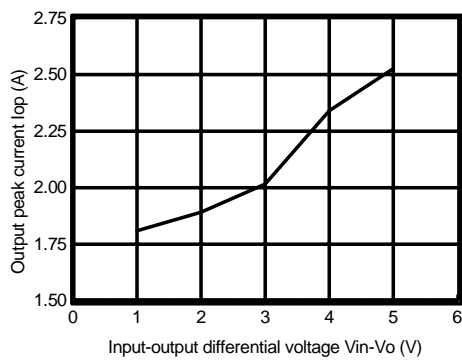
**Typical Performance Characteristics** (Continued)



**Figure 7. Power Dissipation vs. Temperature( $T_j$ )**



**Figure 8. Overcurrent Protection Characteristics (Typical Value)**



**Figure 9. Output Peak Current vs. Input-Output Differential Voltage**

# Typical Performance Characteristics

## KA78R05C

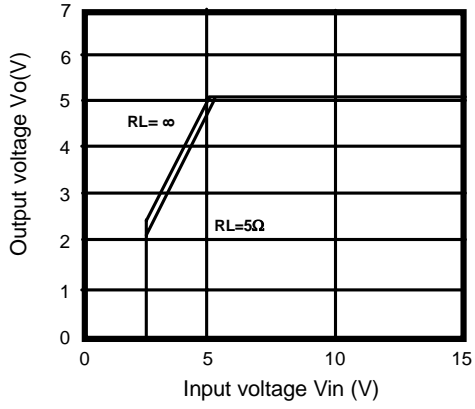


Figure 1. Output Voltage vs. Input Voltage

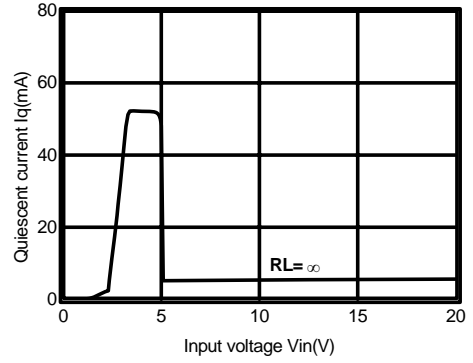


Figure 2. Quiescent Current vs. Input Voltage

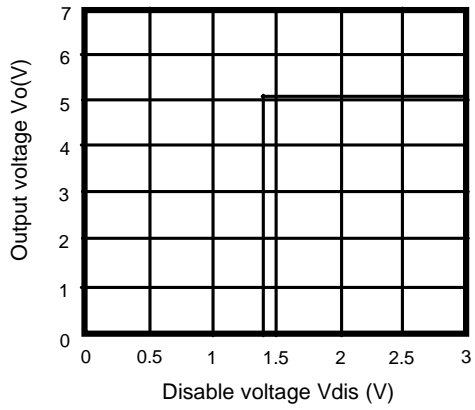


Figure 3. Output Voltage vs. Disable Voltage

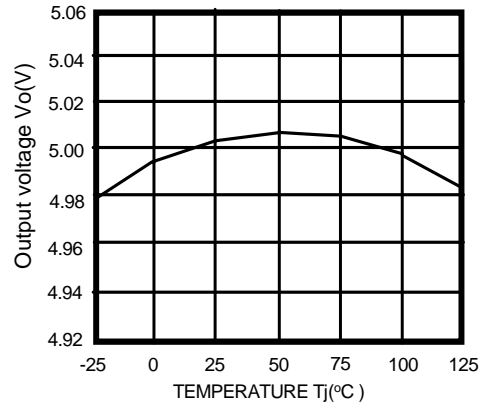


Figure 4. Output Voltage vs. Temperature(Tj)

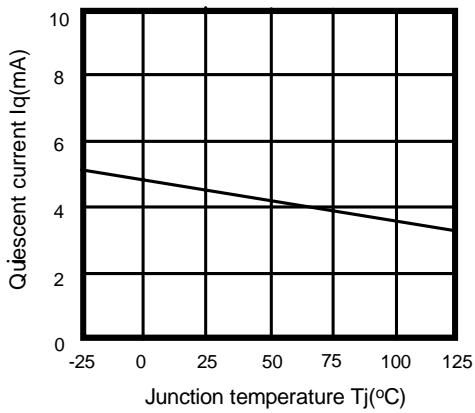


Figure 5. Quiescent Current vs. Temperature(Tj)

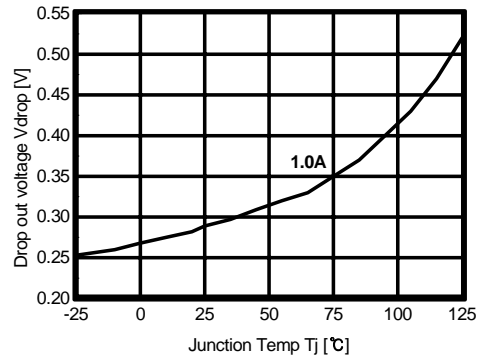
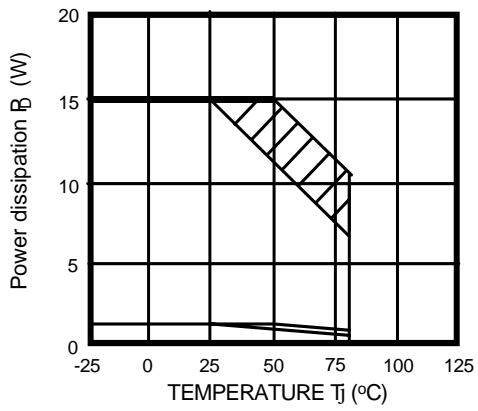
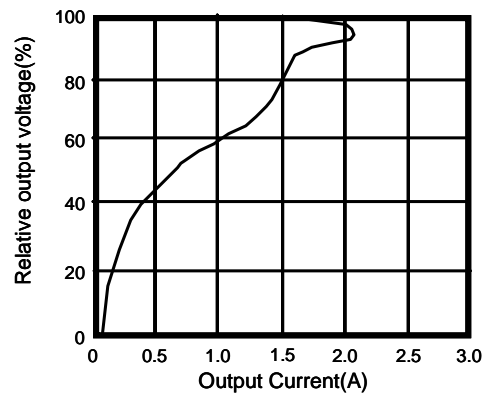


Figure 6. Dropout Voltage vs. Junction Temperature

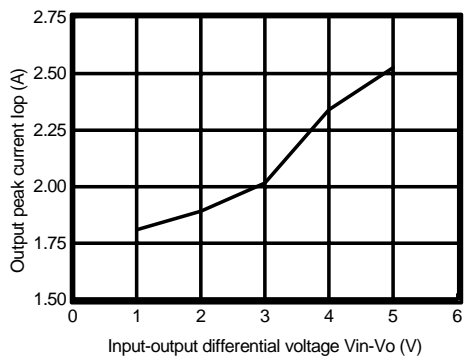
**Typical Performance Characteristics** (Continued)



**Figure 7. Power Dissipation vs. Temperature(Tj)**



**Figure 8. Overcurrent Protection Characteristics (Typical Value)**



**Figure 9. Output Peak Current vs. Input-Output Differential Voltage**

Typical Performance Characteristics (Continued)

KA78R08C

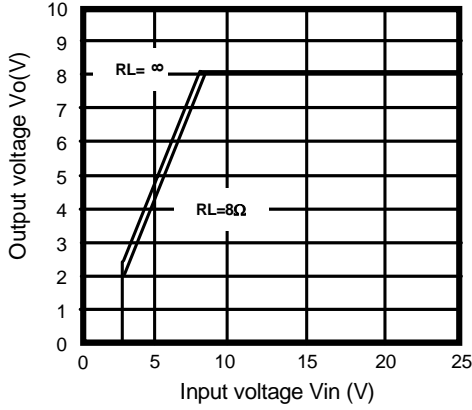


Figure 1. Output Voltage vs. Input Voltage

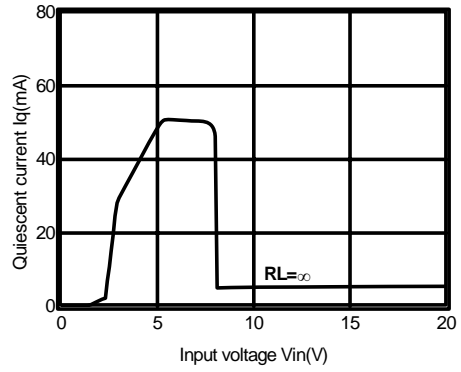


Figure 2. Quiescent Current vs. Input Voltage

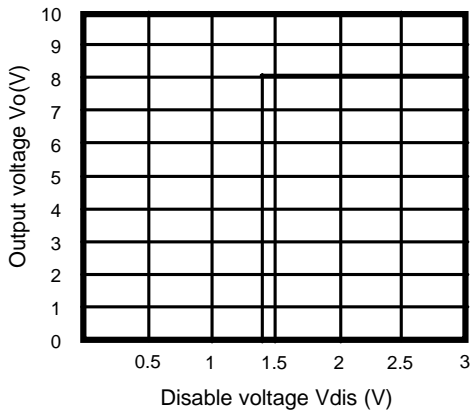


Figure 3. Output Voltage vs. Disable Voltage

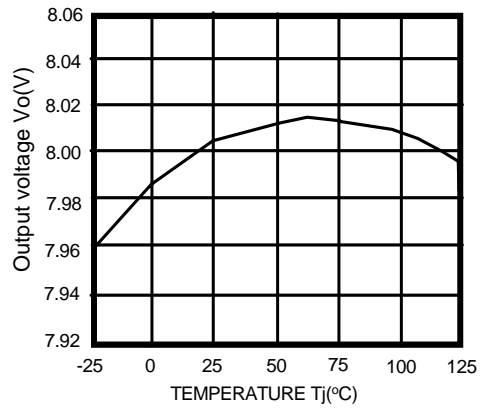


Figure 4. Output Voltage vs. Temperature(Tj)

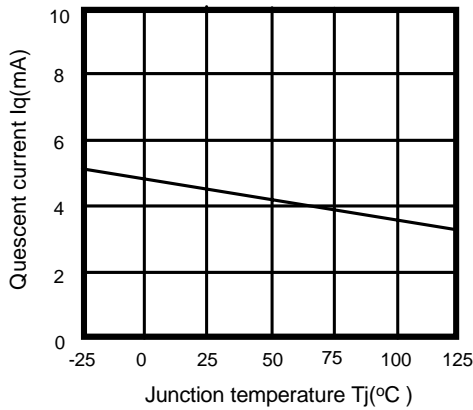


Figure 5. Quiescent Current vs. Temperature(Tj)

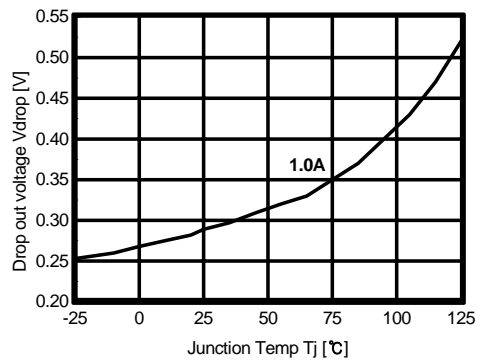
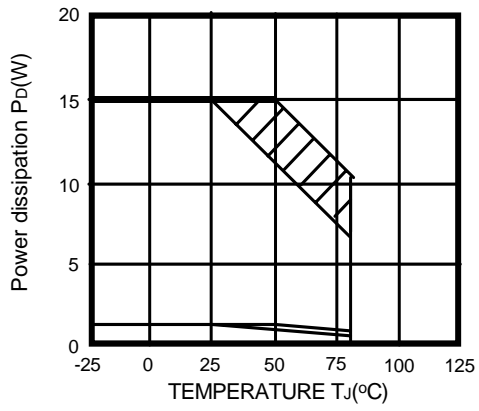
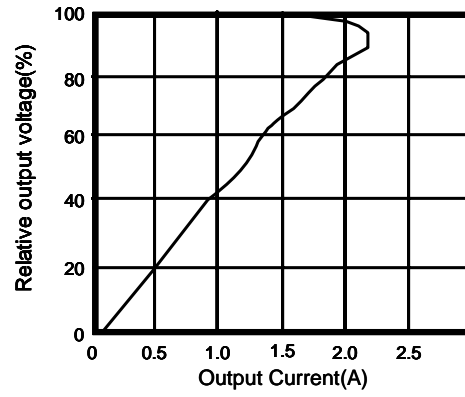


Figure 6. Dropout Voltage vs. Junction Temperature

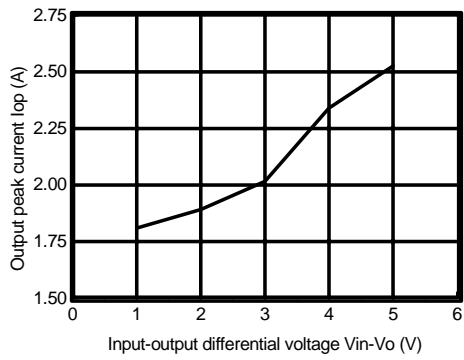
**Typical Performance Characteristics** (Continued)



**Figure 7. Power Dissipation vs. Temperature( $T_j$ )**



**Figure 8. Overcurrent Protection Characteristics (Typical Value)**



**Figure 9. Output Peak Current vs. Input-Output Differential Voltage**

Typical Performance Characteristics (Continued)

KA78R09C

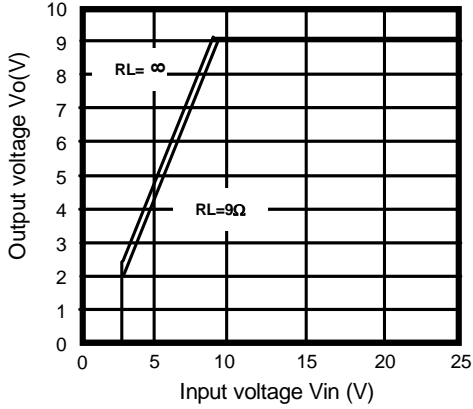


Figure 1. Output Voltage vs. Input Voltage

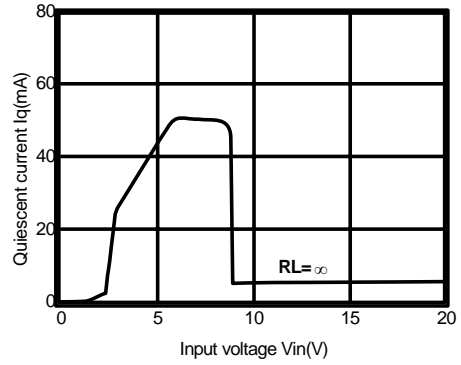


Figure 2. Quiescent Current vs. Input Voltage

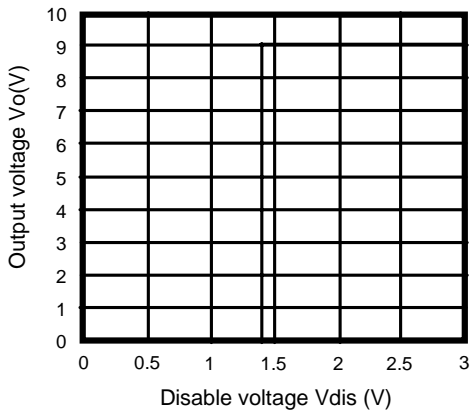


Figure 3. Output Voltage vs. Disable Voltage

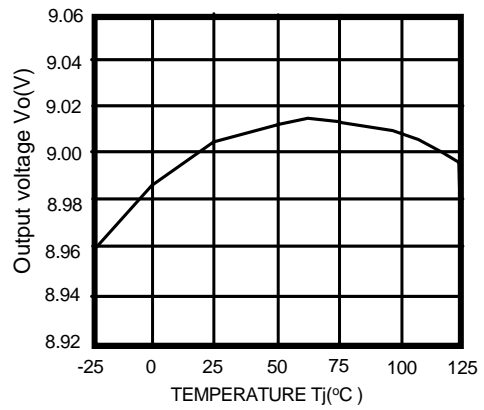


Figure 4. Output Voltage vs. Temperature( $T_j$ )

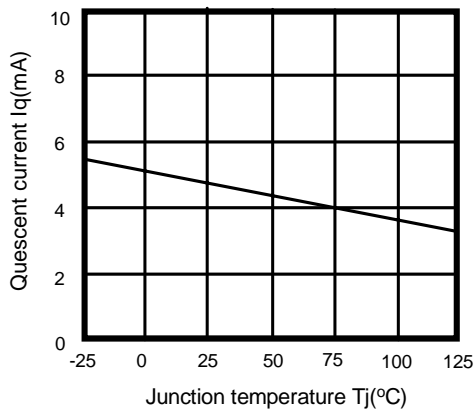


Figure 5. Quiescent Current vs. Temperature( $T_j$ )

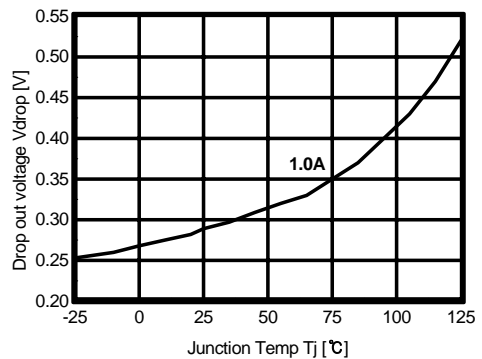
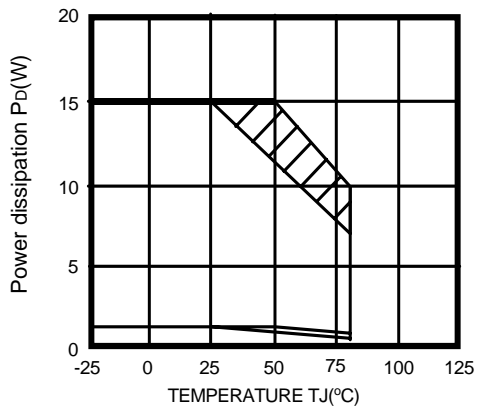
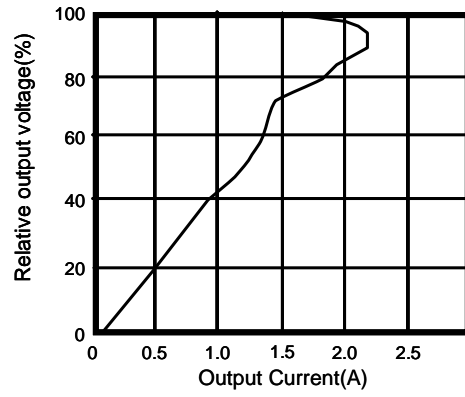


Figure 6. Dropout Voltage vs. Junction Temperature

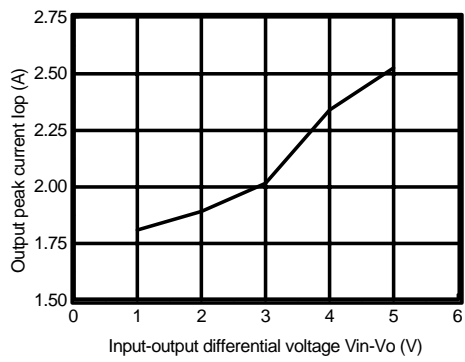
**Typical Performance Characteristics** (Continued)



**Figure 7. Power Dissipation vs. Temperature(Tj)**



**Figure 8. Overcurrent Protection Characteristics (Typical Value)**



**Figure 9. Output Peak Current vs. Input-Output Differential Voltage**

Typical Performance Characteristics (Continued)

KA78R12C

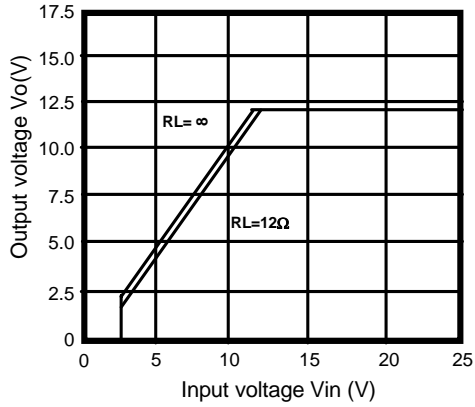


Figure 1. Output Voltage vs. Input Voltage

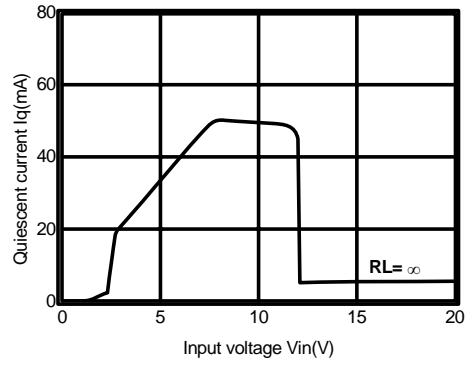


Figure 2. Quiescent Current vs. Input Voltage

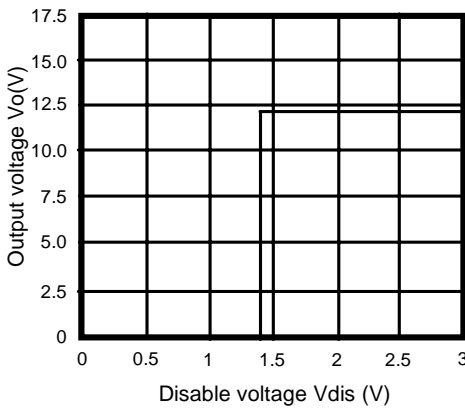


Figure 3. Output Voltage vs. Disable Voltage

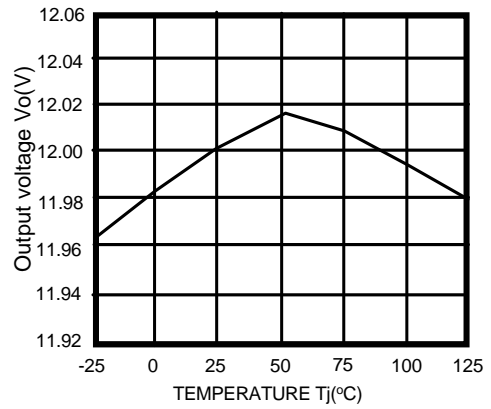


Figure 4. Output Voltage vs. Temperature(Tj)

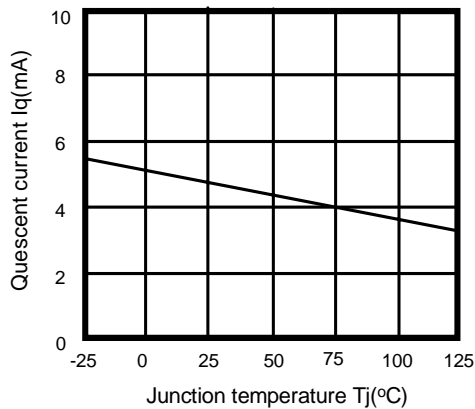


Figure 5. Quiescent Current vs. Temperature(Tj)

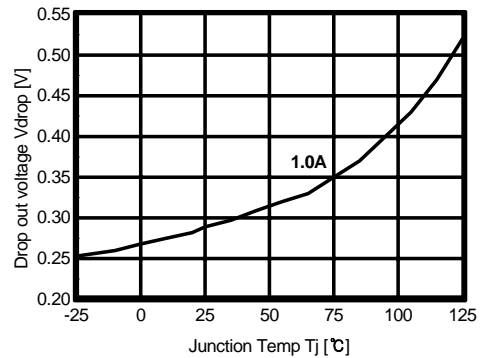
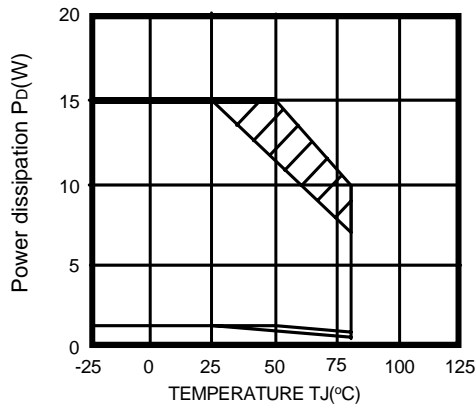
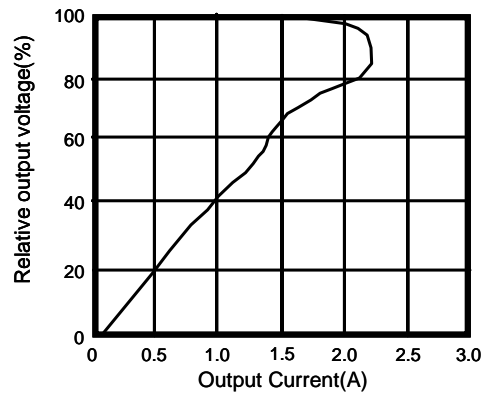


Figure 6. Dropout Voltage vs. Junction Temperature

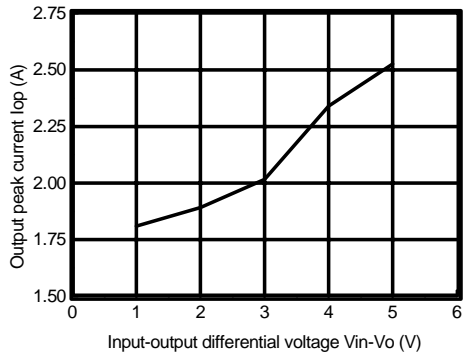
**Typical Performance Characteristics** (Continued)



**Figure 7. Power Dissipation vs. Temperature(Tj)**



**Figure 8. Overcurrent Protection Characteristics (Typical Value)**



**Figure 9. Output Peak Current vs. Input-Output Differential Voltage**

Typical Performance Characteristics (Continued)

KA78R15C

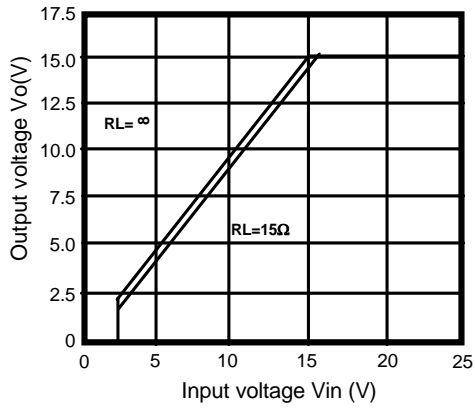


Figure 1. Output Voltage vs. Input Voltage

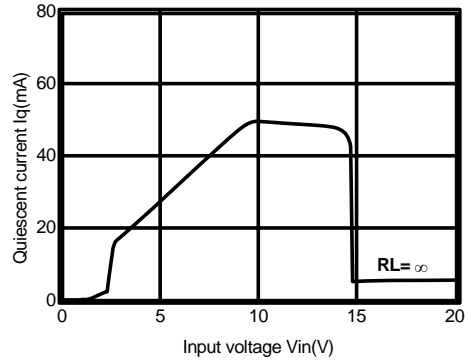


Figure 2. Quiescent Current vs. Input Voltage

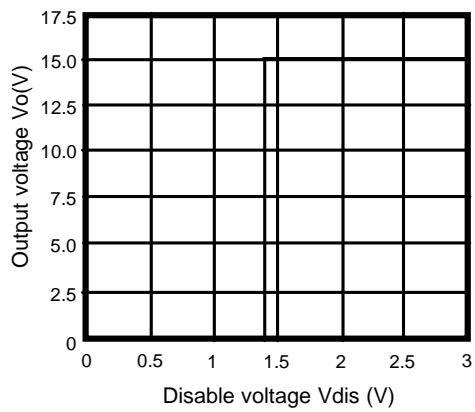


Figure 3. Output Voltage vs. Disable Voltage

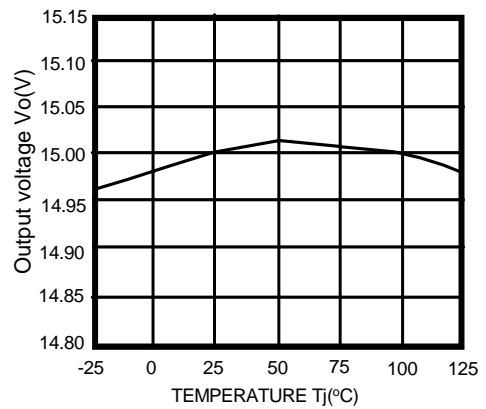


Figure 4. Output Voltage vs. Temperature(Tj)

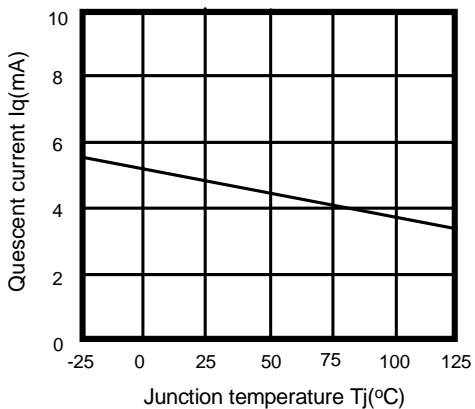


Figure 5. Quiescent Current vs. Temperature(Tj)

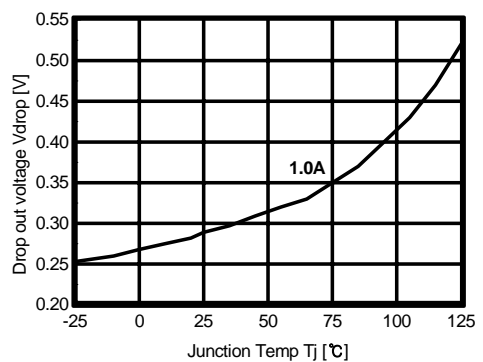
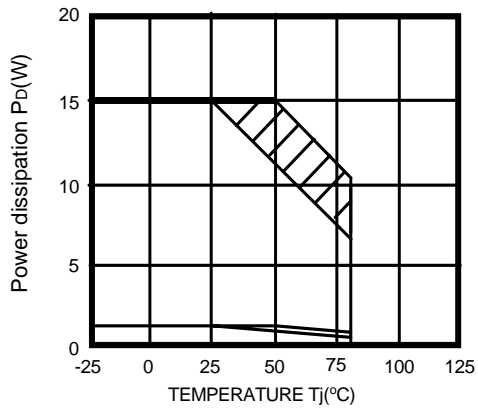
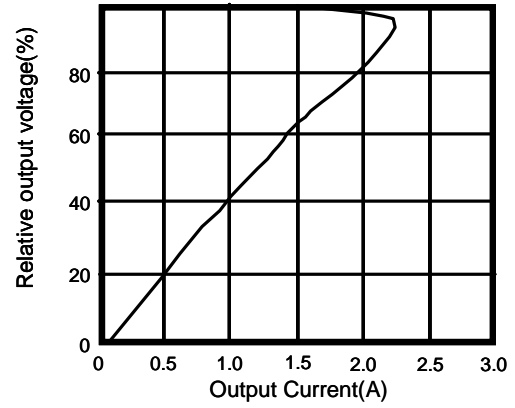


Figure 6. Dropout Voltage vs. Junction Temperature

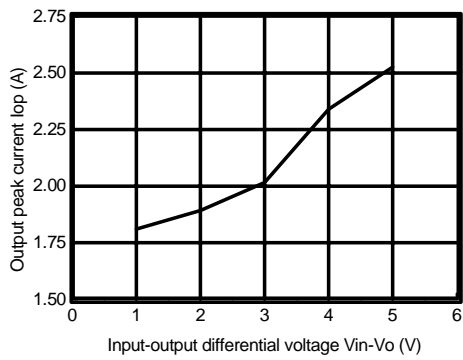
**Typical Performance Characteristics** (Continued)



**Figure 7. Power Dissipation vs. Temperature( $T_j$ )**

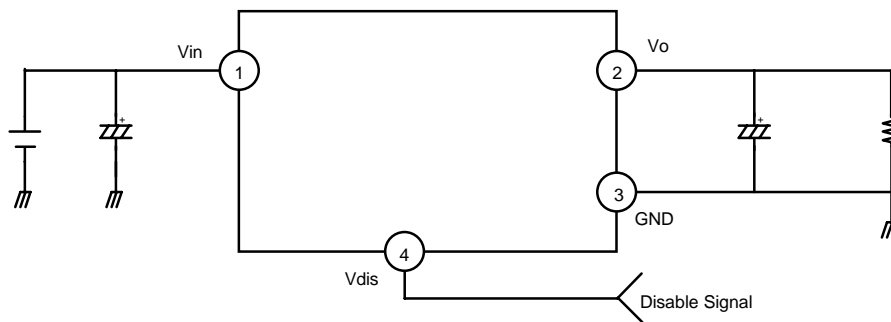


**Figure 8. Overcurrent Protection Characteristics (Typical Value)**



**Figure 9. Output Peak Current vs. Input-Output Differential Voltage**

## Typical Application



**Figure 1. Application Circuit**

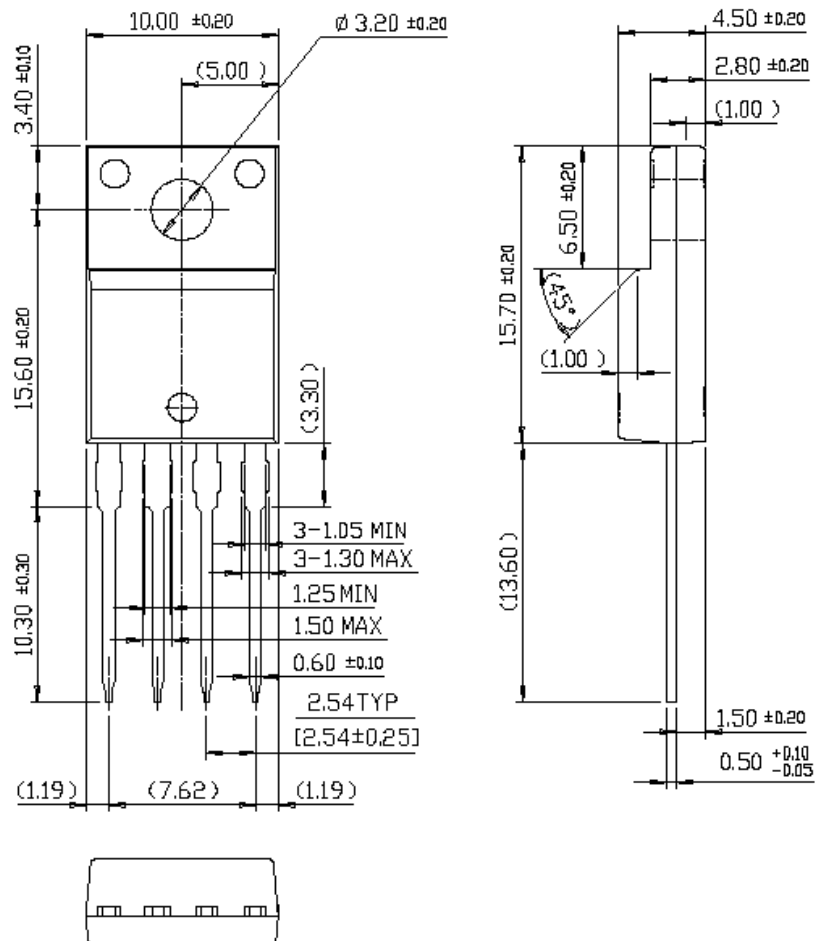
- $C_i$  is required if regulator is located at an appreciable distance from power supply filter.
- $C_o$  improves stability and transient response. ( $C_o > 47\mu\text{F}$ )

## Mechanical Dimensions

Package

Dimensions in millimeters

### TO-220F-4L



## Ordering Information

Product Number	Package	Operating Temperature
KA78R33CTU	TO-220F-4L	-20°C to +80°C
KA78R05CTU		
KA78R08CTU		
KA78R09CTU		
KA78R12CTU		
KA78R15CTU		

### DISCLAIMER

FAIRCHILD SEMICONDUCTOR RESERVES THE RIGHT TO MAKE CHANGES WITHOUT FURTHER NOTICE TO ANY PRODUCTS HEREIN TO IMPROVE RELIABILITY, FUNCTION OR DESIGN. FAIRCHILD DOES NOT ASSUME ANY LIABILITY ARISING OUT OF THE APPLICATION OR USE OF ANY PRODUCT OR CIRCUIT DESCRIBED HEREIN; NEITHER DOES IT CONVEY ANY LICENSE UNDER ITS PATENT RIGHTS, NOR THE RIGHTS OF OTHERS.

### LIFE SUPPORT POLICY

FAIRCHILD'S PRODUCTS ARE NOT AUTHORIZED FOR USE AS CRITICAL COMPONENTS IN LIFE SUPPORT DEVICES OR SYSTEMS WITHOUT THE EXPRESS WRITTEN APPROVAL OF THE PRESIDENT OF FAIRCHILD SEMICONDUCTOR CORPORATION. As used herein:

1. Life support devices or systems are devices or systems which, (a) are intended for surgical implant into the body, or (b) support or sustain life, and (c) whose failure to perform when properly used in accordance with instructions for use provided in the labeling, can be reasonably expected to result in a significant injury of the user.
2. A critical component in any component of a life support device or system whose failure to perform can be reasonably expected to cause the failure of the life support device or system, or to affect its safety or effectiveness.

ON Semiconductor and  are trademarks of Semiconductor Components Industries, LLC dba ON Semiconductor or its subsidiaries in the United States and/or other countries. ON Semiconductor owns the rights to a number of patents, trademarks, copyrights, trade secrets, and other intellectual property. A listing of ON Semiconductor's product/patent coverage may be accessed at [www.onsemi.com/site/pdf/Patent-Marking.pdf](http://www.onsemi.com/site/pdf/Patent-Marking.pdf). ON Semiconductor reserves the right to make changes without further notice to any products herein. ON Semiconductor makes no warranty, representation or guarantee regarding the suitability of its products for any particular purpose, nor does ON Semiconductor assume any liability arising out of the application or use of any product or circuit, and specifically disclaims any and all liability, including without limitation special, consequential or incidental damages. Buyer is responsible for its products and applications using ON Semiconductor products, including compliance with all laws, regulations and safety requirements or standards, regardless of any support or applications information provided by ON Semiconductor. "Typical" parameters which may be provided in ON Semiconductor data sheets and/or specifications can and do vary in different applications and actual performance may vary over time. All operating parameters, including "Typicals" must be validated for each customer application by customer's technical experts. ON Semiconductor does not convey any license under its patent rights nor the rights of others. ON Semiconductor products are not designed, intended, or authorized for use as a critical component in life support systems or any FDA Class 3 medical devices or medical devices with a same or similar classification in a foreign jurisdiction or any devices intended for implantation in the human body. Should Buyer purchase or use ON Semiconductor products for any such unintended or unauthorized application, Buyer shall indemnify and hold ON Semiconductor and its officers, employees, subsidiaries, affiliates, and distributors harmless against all claims, costs, damages, and expenses, and reasonable attorney fees arising out of, directly or indirectly, any claim of personal injury or death associated with such unintended or unauthorized use, even if such claim alleges that ON Semiconductor was negligent regarding the design or manufacture of the part. ON Semiconductor is an Equal Opportunity/Affirmative Action Employer. This literature is subject to all applicable copyright laws and is not for resale in any manner.

## PUBLICATION ORDERING INFORMATION

### LITERATURE FULFILLMENT:

Literature Distribution Center for ON Semiconductor  
19521 E. 32nd Pkwy, Aurora, Colorado 80011 USA  
**Phone:** 303-675-2175 or 800-344-3860 Toll Free USA/Canada  
**Fax:** 303-675-2176 or 800-344-3867 Toll Free USA/Canada  
**Email:** [orderlit@onsemi.com](mailto:orderlit@onsemi.com)

**N. American Technical Support:** 800-282-9855 Toll Free  
USA/Canada  
**Europe, Middle East and Africa Technical Support:**  
Phone: 421 33 790 2910  
**Japan Customer Focus Center**  
Phone: 81-3-5817-1050

**ON Semiconductor Website:** [www.onsemi.com](http://www.onsemi.com)  
**Order Literature:** <http://www.onsemi.com/orderlit>  
For additional information, please contact your local  
Sales Representative

## Looking for pricing, stock, or lifecycle information?

Click below to explore more details on WIN SOURCE:

-  [View KA78R12CTSTU on WIN SOURCE](#)
-  [Fairchild/ON Semiconductor Information](#)

## Optimize Your Supply Chain with WIN SOURCE Solutions

-  Global Sourcing Solution
-  Obsolete Management
-  Cost Control Management
-  Shortage Management
-  Alternative Solution
-  Excess Inventory Management