



**THE DATASHEET OF
AUXHA1051LTR**



IPS1051LPbF / IPS1052GPbF

SINGLE/DUAL CHANNEL INTELLIGENT POWER LOW SIDE SWITCH

Features

- Over temperature shutdown
- Over current shutdown
- Active clamp
- Low current & logic level input
- ESD protection
- Optimized Turn On/Off for EMI
- Diagnostic on the input current

Description

The IPS1051LPbF and IPS1052GPbF are Intelligent Power Switches (IPS) featuring low side MOSFETs with over-current, over-temperature, ESD protection and drain to source active clamp. The IPS1052G is a dual channel device while the IPS1051 is a single channel. These devices offer protections and the high reliability required in harsh environments. Each switch provides efficient protection by turning OFF the power MOSFET when the temperature exceeds 165°C or when the drain current reaches 3A. The device restarts once the input is cycled. A serial resistance connected to the input provides the diagnostic. The avalanche capability is significantly enhanced by the active clamp and covers most inductive load demagnetizations.

Product Summary

Rds(on)	250mΩ (max.)
Vclamp	39V
Ishutdown	2.8A (typ.)

Packages



SOT-223
IPS1051LPbF



SO-8
IPS1052GPbF

Typical Connection

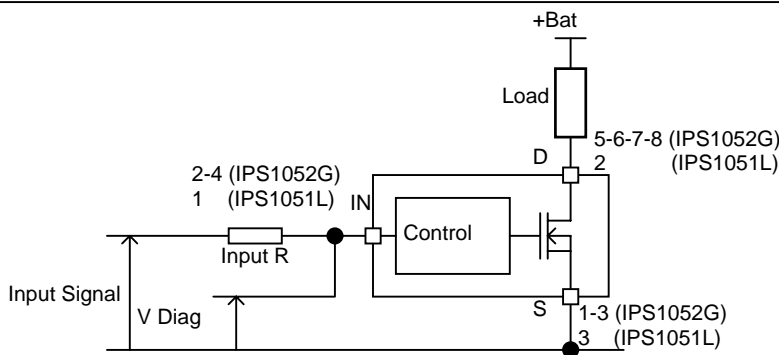

Absolute Maximum Ratings

Absolute maximum ratings indicate sustained limits beyond which damage to the device may occur. All voltage parameters are referenced to Ground lead. (Tambient=25°C unless otherwise specified).

Symbol	Parameter	Min.	Max.	Units
Vds	Maximum drain to source voltage	-0.3	36	V
Vds cont.	Maximum continuous drain to source voltage	-	28	V
Vin	Maximum input voltage	-0.3	6	V
Isd cont.	Max diode continuous current (limited by thermal dissipation)	—	1.3	A
Pd	Maximum power dissipation (internally limited by thermal protection)			
	Rth=60°C/W IPS1051L 1" sqrt. footprint Rth=100°C/W IPS1052G std. footprint		2 1.25	W
ESD	Electrostatic discharge voltage (Human body) C=100pF, R=1500Ω			
	Between drain and source	—	4	kV
	Other combinations	—	3	
	Electrostatic discharge voltage (Machine Model) C=200pF, R=0Ω			
Between drain and source	—	0.5		
	Other combinations	—	0.3	
Tj max.	Max. storage & operating temperature junction temperature	-40	150	°C

Thermal Characteristics

Symbol	Parameter	Typ.	Max.	Units
Rth1	Thermal resistance junction to ambient IPS1051L SOT-223 std. footprint	100	—	°C/W
Rth2	Thermal resistance junction to ambient IPS1051L SOT-223 1" sqrt. footprint	60	—	
Rth1	Thermal resistance junction to ambient IPS1052G SO-8 std. Footprint 1 die active	100	—	
Rth1	Thermal resistance junction to ambient IPS1052G SO-8 std. footprint 2 die active	130	—	

Recommended Operating Conditions

These values are given for a quick design. For operation outside these conditions, please consult the application notes.

Symbol	Parameter	Min.	Max.	Units
VIH	High level input voltage	4.5	5.5	V
VIL	Low level input voltage	0	0.5	
Ids	Continuous drain current, Tambient=85°C, Tj=125°C, Vin=5V Rth=60°C/W IPS1051L 1" sqrt. Footprint	—	1.4	A
	Continuous drain current, Tambient=85°C, Tj=125°C, Vin=5V Rth=100°C/W IPS1052G 1" sqrt. Footprint - 1 die active	—	1.1	A
	Continuous drain current, Tambient=85°C, Tj=125°C, Vin=5V Rth=130°C/W IPS1052G 1" sqrt. Footprint - 2 die active		0.5	A
Rin	Recommended resistor in series with IN pin to generate a diagnostic	0.5	10	kΩ
Max L	Max. recommended load inductance (including line inductance)(1)	—	30	μH
Max. F	Max. frequency	—	10	kHz
Max. t rise	Max. input rise time	—	1	μs

(1) Higher inductance is possible if maximum load current is limited - see figure 11

Static Electrical Characteristics

T_j=25°C, V_{cc}=14V (unless otherwise specified)

Symbol	Parameter	Min.	Typ.	Max.	Units	Test Conditions
R _{ds(on)}	ON state resistance T _j =25°C	—	160	250	mΩ	V _{in} =5V, I _{ds} =1A
	ON state resistance T _j =150°C	—	340	450		
I _{dss1}	Drain to source leakage current	—	0.1	5	μA	V _{cc} =14V, T _j =25°C
I _{dss2}	Drain to source leakage current	—	0.2	10		V _{cc} =28V, T _j =25°C
V _{clamp1}	Drain to source clamp voltage 1	36	38	—	V	I _d =20mA
V _{clamp2}	Drain to source clamp voltage 2	—	39	42		I _d =0.5A
V _{in clamp}	IN to source pin clamp voltage	5.5	6.5	7.5		I _{in} =1mA
V _{th}	Input threshold voltage	—	1.7	—		I _d =10mA

Switching Electrical Characteristics

V_{cc}=14V, Resistive load=10Ω, R_{input}=50Ω, V_{in}=5V, T_j=25°C

Symbol	Parameter	Min.	Typ.	Max.	Units	Test Conditions
T _{don}	Turn-on delay time to 20%	1	3	10	μs	See figure 2
T _r	Rise time 20% to 80%	1	3	10		
T _{doff}	Turn-off delay time to 80%	3	15	40		
T _f	Fall time 80% to 20%	2	4	10		
E _{on} + E _{off}	Turn on and off energy	—	0.1	—	mJ	

Protection Characteristics

Symbol	Parameter	Min.	Typ.	Max.	Units	Test Conditions
T _{sd}	Over temperature threshold	150(2)	165	—	°C	See figure 1
I _{sd}	Over current threshold	1.9	2.8	3.8	A	See figure 1
OV	Over voltage protection (not active when the device is ON)	34	37	—	V	
V _{reset}	IN protection reset threshold	—	1.7	—	V	
T _{reset}	Time to reset protection	15(2)	50	200	μs	V _{in} =0V, T _j =25°C

(2)Guaranteed by design

Diagnostic

Symbol	Parameter	Min.	Typ.	Max.	Units	Test Conditions
I _{in, on}	ON state IN positive current	15	32	70	μA	V _{in} =5V
I _{in, off}	OFF state IN positive current (after protection latched – fault condition)	150	230	350		

All curves are typical values. Operating in the shaded area is not recommended.

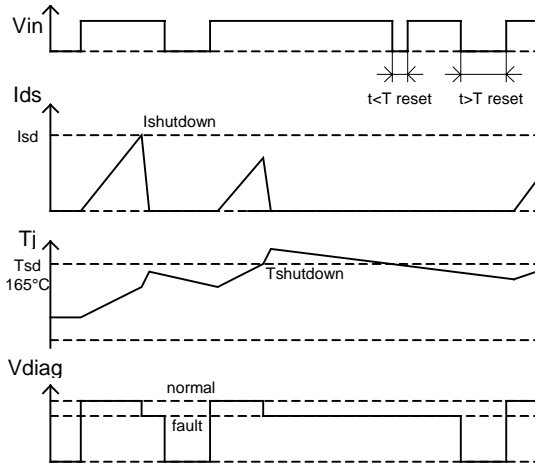

Figure 1 – Timing diagram

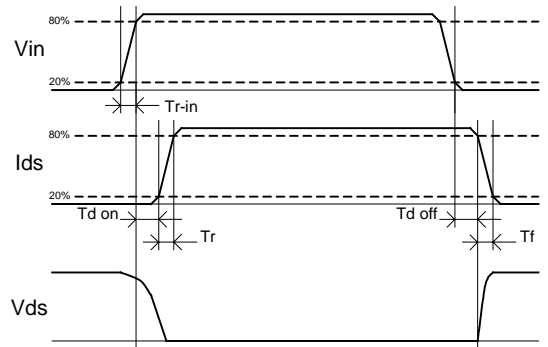

Figure 2 – IN rise time & switching definitions



Figure 3 – Active clamp waveforms

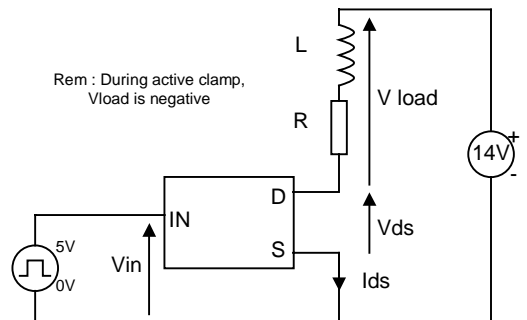

Figure 4 – Active clamp test circuit

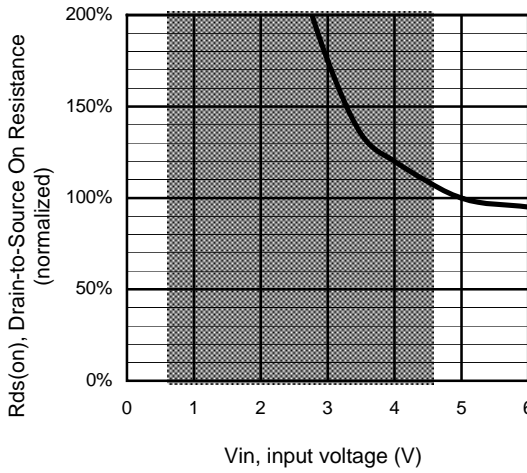

Figure 5 – Normalized Rds(on) (%) Vs Input voltage (V)

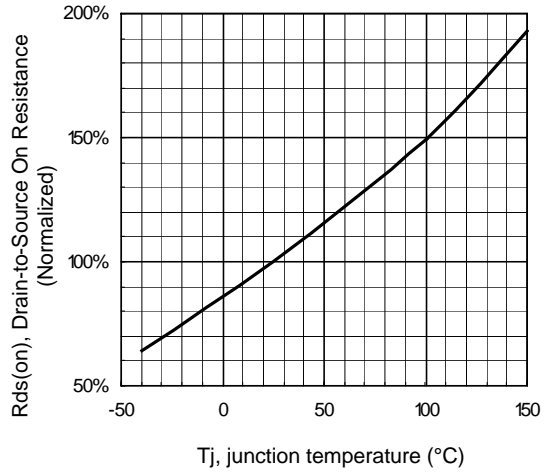

Figure 6 - Normalized Rds(on) (%) Vs Tj (°C)

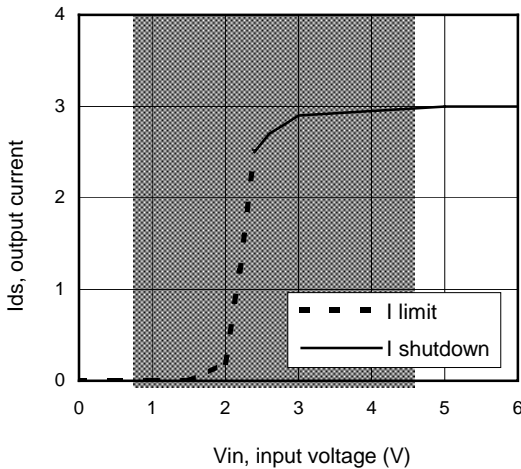

Figure 7 – Current limitation and current shutdown Vs Input voltage (V)

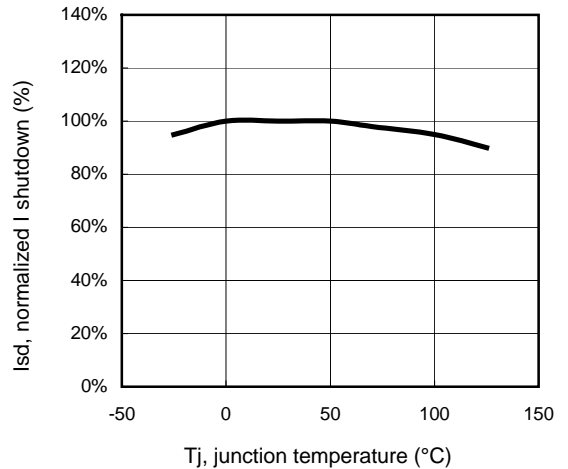

Figure 8 – Normalized I shutdown (%) Vs junction temperature (°C)

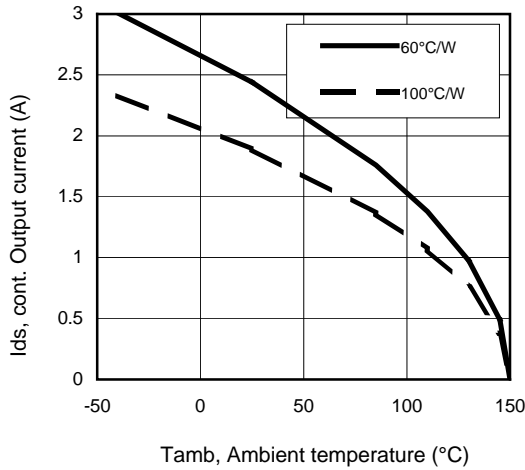

Figure 9 – Max. continuous output current (A) Vs Ambient temperature (°C)

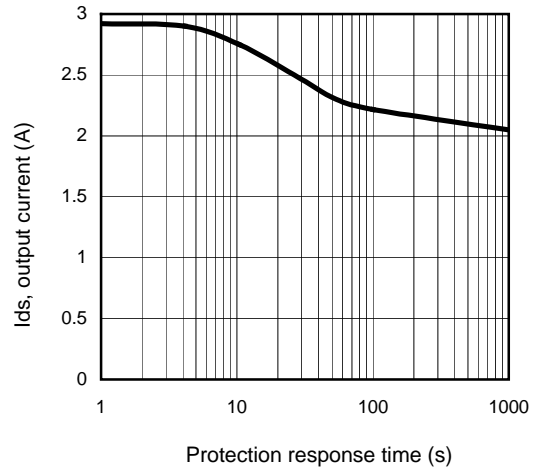

Figure 10 – Ids (A) Vs over temperature protection response time (s) / IPS1051L

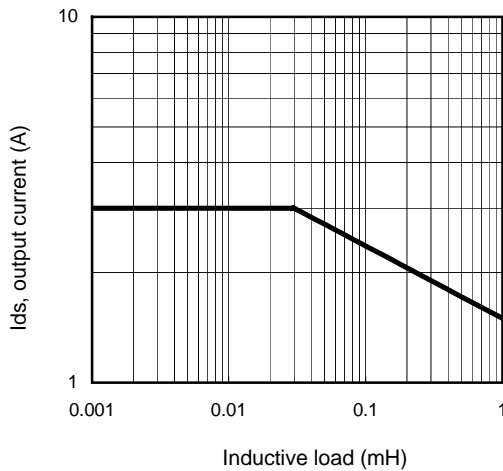

Figure 11 – Max. output current (A) Vs Inductive load (mH)

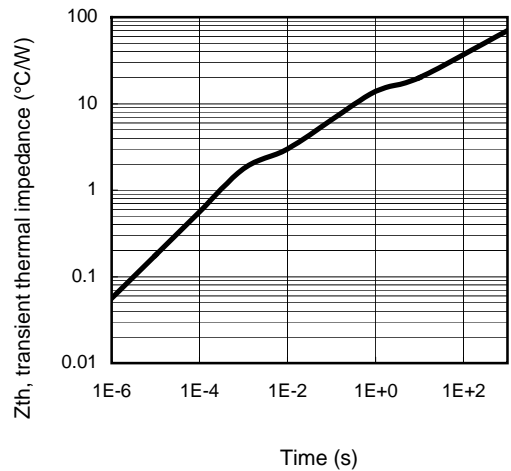

Figure 12 – Transient thermal impedance (°C/W) Vs time (s)

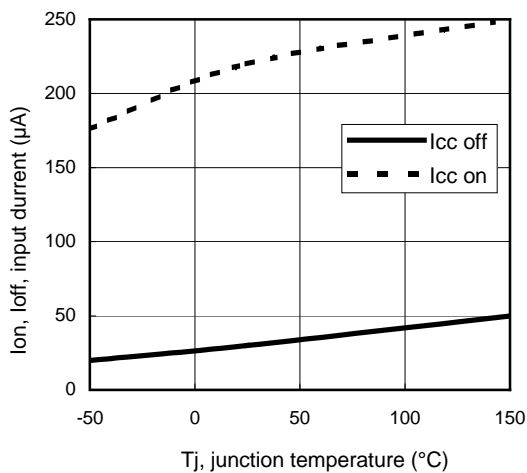

Figure 13 – Input current (µA) On and Off Vs junction temperature (°C)

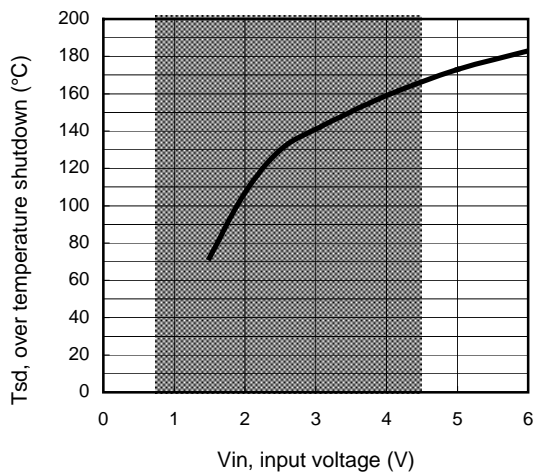
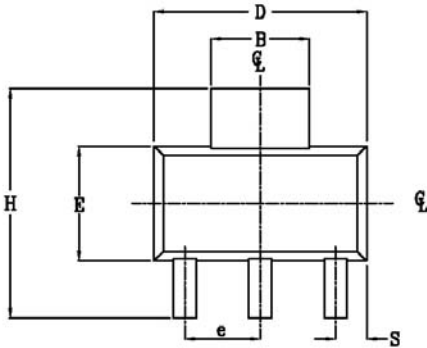
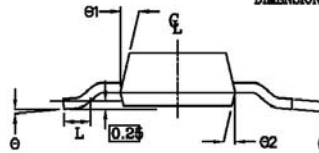
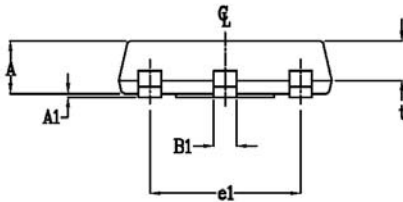

Figure 14 – Over temperature shutdown (°C) Vs input voltage (V)

Case Outline - SOT-223 - Automotive Q100 PbF MSL2 qualified



POS	MILLIMETERS		INCHES	
	MAX	MIN	MAX	MIN
A	1.70	1.50	.067	.060
A1	0.10	0.02	.004	.0008
B	3.15	2.95	.124	.116
B1	0.85	0.65	.033	.026
C	0.35	0.25	.014	.010
D	6.70	6.30	.264	.248
e	2.30	NOM	.0905	NOM
e1	4.60	NOM	.181	NOM
E	3.70	3.30	.146	.130
H	7.30	6.70	.287	.264
S	1.05	0.85	.041	.033
t	1.30	1.10	.051	.043
Ø	10° MAX		10° MAX	
Ø1	16°	10°	16°	10°
Ø2	16°	10°	16°	10°
L	0.75 MIN		0.0295 MIN	



NOTE:
 1. PACKAGE OUTLINE EXCLUSIVE OF ANY MOLD FLASHES DIMENSION.
 2. PACKAGE OUTLINE EXCLUSIVE OF BURR DIMENSION.

Leads and drain are plated with 100% Sn

Tape & Reel - SOT-223

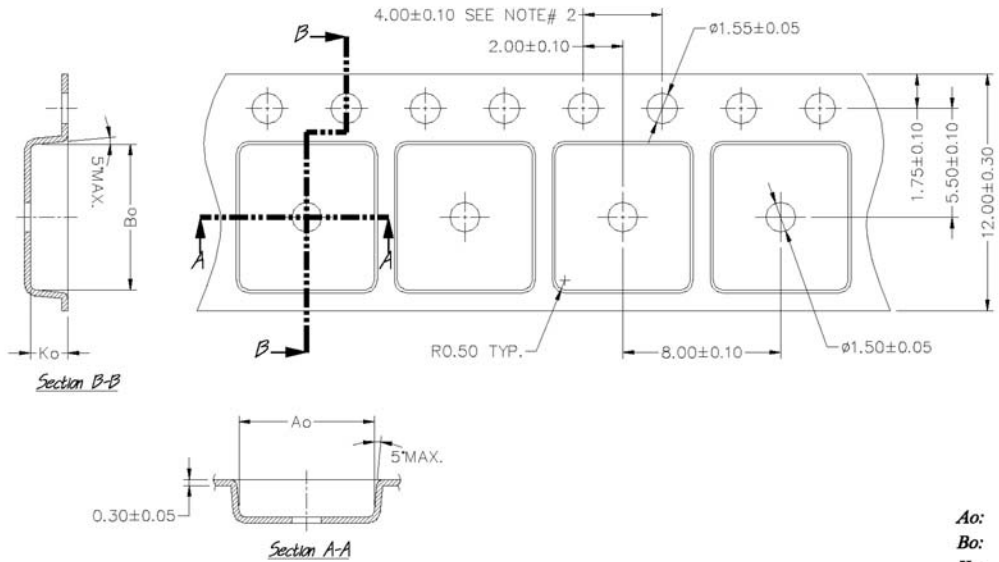

<i>A₀</i>	6.85
<i>B₀</i>	7.40
<i>K₀</i>	1.90
<i>Pitch</i>	8.00
<i>Width</i>	12.00

NOTES:

1. A_0 & B_0 are measured at 0.3mm above base of pocket.
2. 10 pitches cumulative tol. ± 0.2 mm.

Case Outline - SO-8 - Automotive Q100 PbF MSL2 qualified

Dimensions are shown in millimeters (inches)

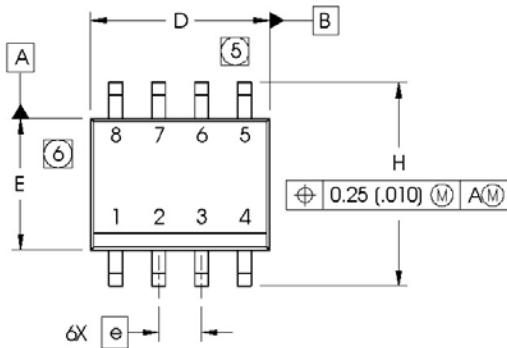

DIM	INCHES		MILLIMETERS	
	MIN	MAX	MIN	MAX
A	.0532	.0688	1.35	1.75
A1	.0040	.0098	0.10	0.25
b	.013	.020	0.33	0.51
c	.0075	.0098	0.19	0.25
D	.189	.1968	4.80	5.00
E	.1497	.1574	3.80	4.00
e	.050 BASIC		1.27 BASIC	
e1	.025 BASIC		0.635 BASIC	
H	.2284	.2440	5.80	6.20
K	.0099	.0196	0.25	0.50
L	.016	.050	0.40	1.27
y	0°	8°	0°	8°

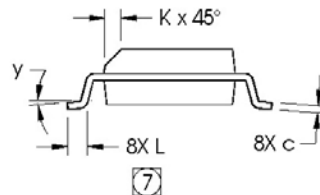
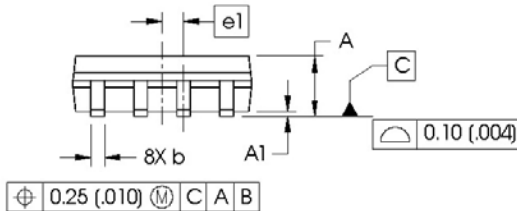

NOTES:

1. DIMENSIONING & TOLERANCING PER ASME Y14.5M-1994.
2. CONTROLLING DIMENSION: MILLIMETER
3. DIMENSIONS ARE SHOWN IN MILLIMETERS (INCHES).
4. OUTLINE CONFORMS TO JEDEC OUTLINE MS-012AA.
5. DIMENSION DOES NOT INCLUDE MOLD PROTRUSIONS. MOLD PROTRUSIONS NOT TO EXCEED 0.15 (.006).
6. DIMENSION DOES NOT INCLUDE MOLD PROTRUSIONS. MOLD PROTRUSIONS NOT TO EXCEED 0.25 (.010).
7. DIMENSION IS THE LENGTH OF LEAD FOR SOLDERING TO A SUBSTRATE.

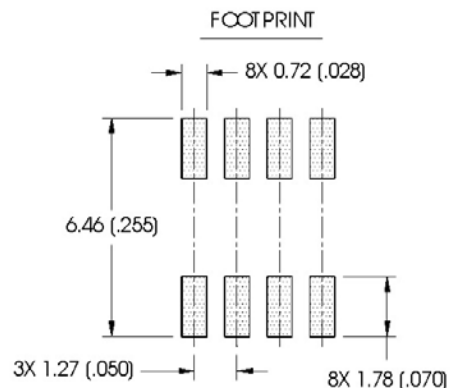

Leads and drain are plated with 100% Sn

Tape & Reel - SO-8

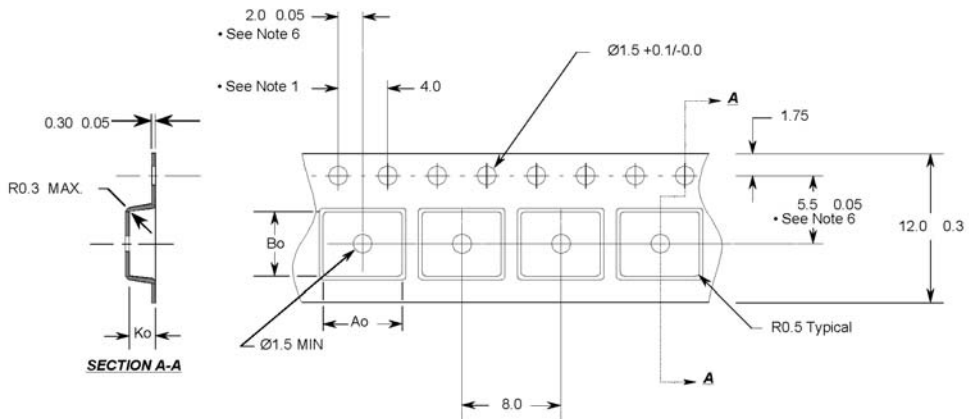

Notes:

1. 10 sprocket hole pitch cumulative tolerance 0.2
2. Camber not to exceed 1mm in 100mm
3. Material: Black Conductive Advantek Polystyrene
4. Ao and Bo measured on a plane 0.3mm above the bottom of the pocket
5. Ko measured from a plane on the inside bottom of the pocket to the top surface of the carrier.
6. Pocket position relative to sprocket hole measured as true position of pocket, not pocket hole.

Ao = 6.4 mm
 Bo = 5.2 mm
 Ko = 2.1 mm

- All Dimensions in Millimeters -

Looking for pricing, stock, or lifecycle information?

Click below to explore more details on WIN SOURCE:

- ⊖ [View AUXHA1051LTR on WIN SOURCE](#)
- ⊖ [Infineon Technologies](#) Information

Optimize Your Supply Chain with WIN SOURCE Solutions

- ✓ Global Sourcing Solution
- ✓ Obsolete Management
- ✓ Cost Control Management
- ✓ Shortage Management
- ✓ Alternative Solution
- ✓ Excess Inventory Management