



SMT inductors

SIMID series, SIMID 1812-A

Series/Type: **B82432A**

Date: **October 2012**

© EPCOS AG 2015. Reproduction, publication and dissemination of this publication, enclosures hereto and the information contained therein without EPCOS' prior express consent is prohibited.

EPCOS AG is a TDK Group Company.

SIMID 1812-A
SMD

Size 1812 (EIA) or 4532 (IEC)
Rated inductance 1 ... 1000 μ H
Rated current 55 ... 600 mA

Construction

- Ferrite core
- Ultrasonic-welded winding
- Flame-retardant molding

Features

- High Q factor
- High resonance frequency
- Suitable for lead-free reflow soldering
as referenced in JEDEC J-STD 020D
- RoHS-compatible

Applications

- Filtering of supply voltages, coupling, decoupling
- Antenna systems
- Automotive electronics
- Telecommunications
- Industrial electronics

Terminals

- Base material CuSn6
- Layer composition Cu, Ag (lead-free)
- Electro-plated

Marking

- Marking on component:
Manufacturer and series mark “–”
L value (in nH), tolerance of L value (coded),
date of manufacture (YWWDD)
- Minimum data on reel:
Manufacturer, ordering code, L value, quantity,
date of packing

Delivery mode and packing unit

- 12-mm blister tape, wound on 330-mm \varnothing reel
- Packing unit: 2500 pcs./reel

SIMID 1812-A

SMD

Dimensional drawing and layout recommendation

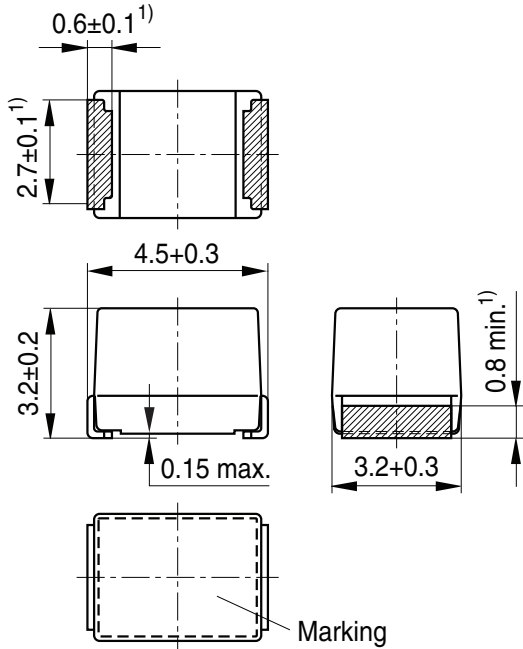

A	B	C	D
3.6	1.3	3.2	5.8

1) Soldering area

IND0078-R-E

Dimensions in mm

Taping and packing

Blister tape

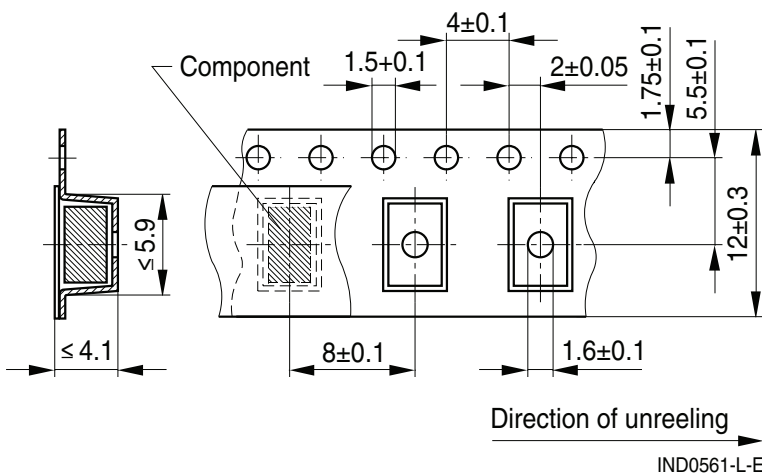

Dimensions in mm

Reel

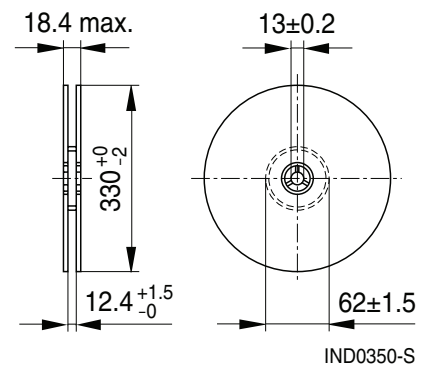

SMD
Technical data and measuring conditions

Rated inductance L_R	Measured with impedance analyzer Agilent 4294A at frequency f_L , 0.1 V, +20 °C
Q factor Q_{\min}	Measured with impedance analyzer Agilent 4294A at frequency f_Q , +20 °C
Rated temperature T_R	+85 °C
Rated current I_R	Maximum permissible DC with inductance decrease $\Delta L/L_0 \leq 10\%$ and temperature increase of ≤ 30 K at rated temperature
Self-resonance frequency $f_{\text{res},\min}$	Measured with impedance analyzer Agilent E4991A, +20 °C
DC resistance R_{\max}	Measured at +20 °C
Solderability (lead-free)	Sn95.5Ag3.8Cu0.7: +(245 ±5) °C, (5 ±0.3) s Wetting of soldering area $\geq 95\%$ (based on IEC 60068-2-58)
Resistance to soldering heat	+260 °C, 40 s (as referenced in JEDEC J-STD 020D)
Climatic category	55/125/56 (to IEC 60068-1)
Storage conditions	Mounted: -55 °C ... +125 °C Packaged: -25 °C ... +40 °C, $\leq 75\%$ RH
Weight	Approx. 130 mg

Characteristics and ordering codes

L_R μH	Tolerance	f_L MHz	Q_{\min}	f_Q MHz	I_R mA	R_{\max} Ω	$f_{\text{res},\min}$ MHz	Ordering code
1.0	$\pm 10\% \triangleq K$	1	25	7.96	600	0.28	260	B82432A1102K000
1.2		1	25	7.96	560	0.32	250	B82432A1122K000
1.5		1	25	7.96	535	0.35	230	B82432A1152K000
1.8		1	25	7.96	490	0.41	210	B82432A1182K000
2.2		1	30	7.96	480	0.43	190	B82432A1222K000
2.7		1	30	7.96	450	0.49	170	B82432A1272K000
3.3		1	30	7.96	425	0.55	155	B82432A1332K000
3.9		1	30	7.96	410	0.59	145	B82432A1392K000
4.7		1	30	7.96	390	0.65	110	B82432A1472K000
5.6		1	30	7.96	375	0.71	100	B82432A1562K000
6.8		1	30	7.96	360	0.78	75	B82432A1682K000
8.2		1	30	7.96	330	0.92	23	B82432A1822K000

Higher currents possible at temperatures $< T_R$ on request.

Closer tolerances and special versions on request.

SMD
Characteristics and ordering codes

L_R μH	Tolerance	f_L MHz	Q_{\min}	f_Q MHz	I_R mA	R_{\max} Ω	$f_{\text{res,min}}$ MHz	Ordering code ¹⁾
10	$\pm 10\% \triangleq K$	1	45	2.52	320	0.98	22	B82432A1103K000
12		0.1	45	2.52	300	1.10	19	B82432A1123K000
15		0.1	45	2.52	280	1.25	17	B82432A1153K000
18		0.1	45	2.52	270	1.35	15	B82432A1183K000
22		0.1	45	2.52	260	1.45	13	B82432A1223K000
27		0.1	45	2.52	245	1.65	12	B82432A1273K000
33	$\pm 5\% \triangleq J$ $\pm 10\% \triangleq K$	0.1	45	2.52	230	1.85	10.5	B82432A1333+000
39		0.1	45	2.52	220	2.05	10.0	B82432A1393+000
47		0.1	40	2.52	210	2.3	9.5	B82432A1473+000
56		0.1	40	2.52	200	2.5	9.0	B82432A1563+000
68		0.1	40	2.52	190	2.8	8.0	B82432A1683+000
82		0.1	35	2.52	175	3.2	7.0	B82432A1823+000
100		0.1	40	2.52	145	4.7	6.5	B82432A1104+000
120		0.1	35	0.796	140	5.2	6.0	B82432A1124+000
150		0.1	35	0.796	130	6.1	5.5	B82432A1154+000
180		0.1	35	0.796	120	6.9	5.0	B82432A1184+000
220		0.1	30	0.796	115	7.5	4.6	B82432A1224+000
270		0.1	30	0.796	90	12.5	4.4	B82432A1274+000
330		0.1	30	0.796	85	14.1	4.1	B82432A1334+000
390		0.1	35	0.796	80	15.3	3.8	B82432A1394+000
470		0.1	35	0.796	75	17.5	3.5	B82432A1474+000
560		0.1	30	0.796	70	23.0	2.8	B82432A1564+000
680		0.1	30	0.796	65	25.0	2.6	B82432A1684+000
820		0.1	30	0.796	60	28.0	2.5	B82432A1824+000
1000		0.1	30	0.796	55	32.0	2.3	B82432A1105+000

Higher currents possible at temperatures $<T_R$ on request.
Closer tolerances and special versions on request.

1) Replace the + by the code letter for the required inductance tolerance.

SMD

Impedance |Z| versus frequency f
measured with impedance analyzer
Agilent E4991A, typical values at +20 °C

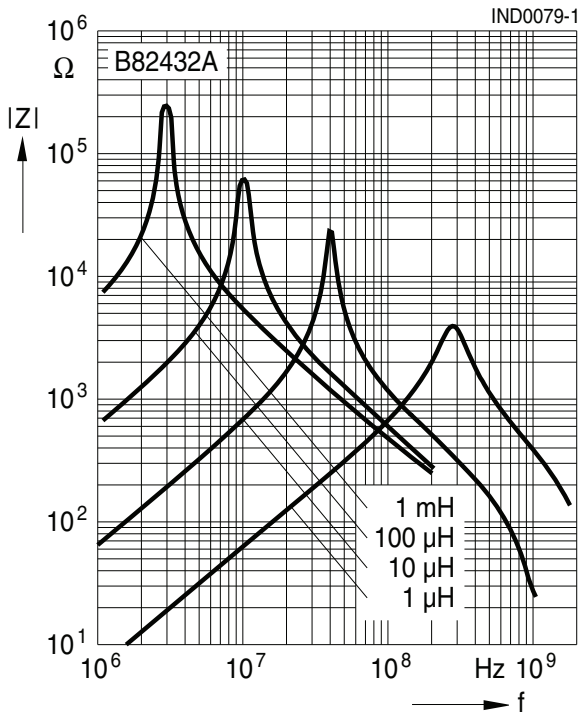

Inductance L versus DC load current I_{DC}
measured with LCR meter Agilent 4285A,
typical values at +20 °C

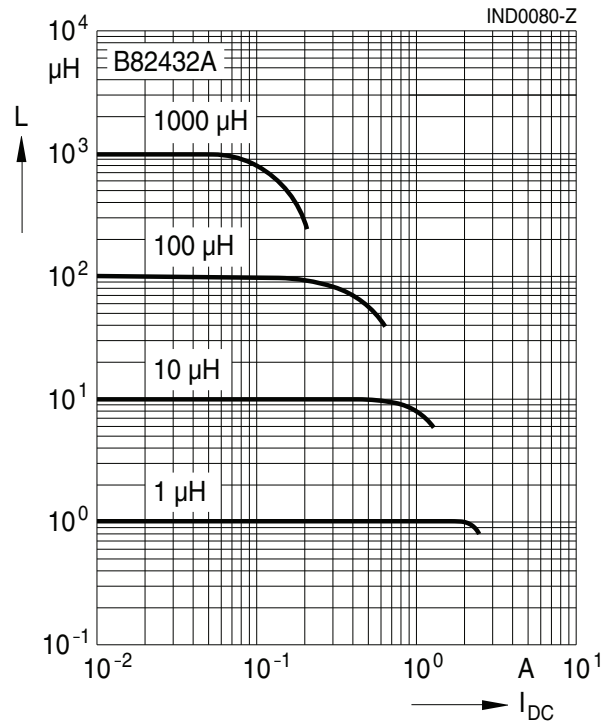

Q factor versus frequency f
measured with impedance analyzer
Agilent E4991A, typical values at +20 °C

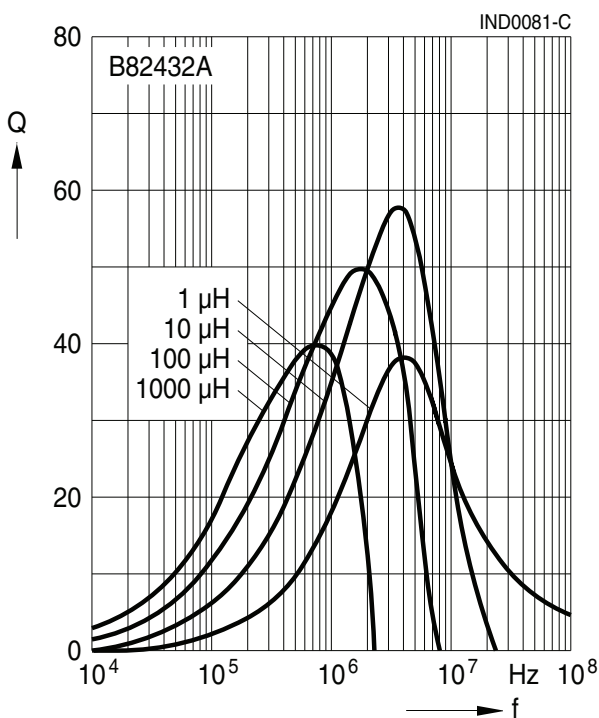

Current derating I_{op}/I_R versus ambient temperature T_A
(rated temperature T_R = +85 °C)



Cautions and warnings

- Please note the recommendations in our Inductors data book (latest edition) and in the data sheets.
 - Particular attention should be paid to the derating curves given there.
 - The soldering conditions should also be observed. Temperatures quoted in relation to wave soldering refer to the pin, not the housing.
- If the components are to be washed varnished it is necessary to check whether the washing varnish agent that is used has a negative effect on the wire insulation, any plastics that are used, or on glued joints. In particular, it is possible for washing varnish agent residues to have a negative effect in the long-term on wire insulation.
Washing processes may damage the product due to the possible static or cyclic mechanical loads (e.g. ultrasonic cleaning). They may cause cracks to develop on the product and its parts, which might lead to reduced reliability or lifetime.
- The following points must be observed if the components are potted in customer applications:
 - Many potting materials shrink as they harden. They therefore exert a pressure on the plastic housing or core. This pressure can have a deleterious effect on electrical properties, and in extreme cases can damage the core or plastic housing mechanically.
 - It is necessary to check whether the potting material used attacks or destroys the wire insulation, plastics or glue.
 - The effect of the potting material can change the high-frequency behaviour of the components.
- Ferrites are sensitive to direct impact. This can cause the core material to flake, or lead to breakage of the core.
- Even for customer-specific products, conclusive validation of the component in the circuit can only be carried out by the customer.

Important notes

The following applies to all products named in this publication:



1. Some parts of this publication contain **statements about the suitability of our products for certain areas of application**. These statements are based on our knowledge of typical requirements that are often placed on our products in the areas of application concerned. We nevertheless expressly point out **that such statements cannot be regarded as binding statements about the suitability of our products for a particular customer application**. As a rule we are either unfamiliar with individual customer applications or less familiar with them than the customers themselves. For these reasons, it is always ultimately incumbent on the customer to check and decide whether a product with the properties described in the product specification is suitable for use in a particular customer application.
2. We also point out that **in individual cases, a malfunction of electronic components or failure before the end of their usual service life cannot be completely ruled out in the current state of the art, even if they are operated as specified**. In customer applications requiring a very high level of operational safety and especially in customer applications in which the malfunction or failure of an electronic component could endanger human life or health (e.g. in accident prevention or life-saving systems), it must therefore be ensured by means of suitable design of the customer application or other action taken by the customer (e.g. installation of protective circuitry or redundancy) that no injury or damage is sustained by third parties in the event of malfunction or failure of an electronic component.
3. **The warnings, cautions and product-specific notes must be observed.**
4. In order to satisfy certain technical requirements, **some of the products described in this publication may contain substances subject to restrictions in certain jurisdictions (e.g. because they are classed as hazardous)**. Useful information on this will be found in our Material Data Sheets on the Internet (www.tdk-electronics.tdk.com/material). Should you have any more detailed questions, please contact our sales offices.
5. We constantly strive to improve our products. Consequently, **the products described in this publication may change from time to time**. The same is true of the corresponding product specifications. Please check therefore to what extent product descriptions and specifications contained in this publication are still applicable before or when you place an order.

We also **reserve the right to discontinue production and delivery of products**. Consequently, we cannot guarantee that all products named in this publication will always be available. The aforementioned does not apply in the case of individual agreements deviating from the foregoing for customer-specific products.
6. Unless otherwise agreed in individual contracts, **all orders are subject to our General Terms and Conditions of Supply**.
7. **Our manufacturing sites serving the automotive business apply the IATF 16949 standard**. The IATF certifications confirm our compliance with requirements regarding the quality management system in the automotive industry. Referring to customer requirements and customer specific requirements ("CSR") TDK always has and will continue to have the policy of respecting individual agreements. Even if IATF 16949 may appear to support the acceptance of unilateral requirements, we hereby like to emphasize that **only requirements mutually agreed upon can and will be implemented in our Quality Management System**. For clarification purposes we like to point out that obligations from IATF 16949 shall only become legally binding if individually agreed upon.
8. The trade names EPCOS, CeraCharge, CeraDiode, CeraLink, CeraPad, CeraPlas, CSMP, CTVS, DeltaCap, DigiSiMic, ExoCore, FilterCap, FormFit, LeaXield, MiniBlue, MiniCell, MKD, MKK, MotorCap, PCC, PhaseCap, PhaseCube, PhaseMod, PhiCap, PowerHap, PQSine, PQvar, SIFERRIT, SIFI, SIKOREL, SilverCap, SIMDAD, SiMic, SIMID, SineFormer, SIOV, ThermoFuse, WindCap are **trademarks registered or pending** in Europe and in other countries. Further information will be found on the Internet at www.tdk-electronics.tdk.com/trademarks.

Release 2018-10

Looking for pricing, stock, or lifecycle information?

Click below to explore more details on WIN SOURCE:

-  [View B82432A1474K000 on WIN SOURCE](#)
-  [EPCOS \(TDK\) Information](#)

Optimize Your Supply Chain with WIN SOURCE Solutions

-  Global Sourcing Solution
-  Obsolete Management
-  Cost Control Management
-  Shortage Management
-  Alternative Solution
-  Excess Inventory Management