



**THE DATASHEET OF  
PBSS4480X,135**



## Important notice

Dear Customer,

On 7 February 2017 the former NXP Standard Product business became a new company with the tradename **Nexperia**. Nexperia is an industry leading supplier of Discrete, Logic and PowerMOS semiconductors with its focus on the automotive, industrial, computing, consumer and wearable application markets

In data sheets and application notes which still contain NXP or Philips Semiconductors references, use the references to Nexperia, as shown below.

Instead of <http://www.nxp.com>, <http://www.philips.com/> or <http://www.semiconductors.philips.com/>, use <http://www.nexperia.com>

Instead of [sales.addresses@www.nxp.com](mailto:sales.addresses@www.nxp.com) or [sales.addresses@www.semiconductors.philips.com](mailto:sales.addresses@www.semiconductors.philips.com), use [salesaddresses@nexperia.com](mailto:salesaddresses@nexperia.com) (email)

Replace the copyright notice at the bottom of each page or elsewhere in the document, depending on the version, as shown below:

- © NXP N.V. (year). All rights reserved or © Koninklijke Philips Electronics N.V. (year). All rights reserved

Should be replaced with:

- © **Nexperia B.V. (year). All rights reserved.**

If you have any questions related to the data sheet, please contact our nearest sales office via e-mail or telephone (details via [salesaddresses@nexperia.com](mailto:salesaddresses@nexperia.com)). Thank you for your cooperation and understanding,

Kind regards,

Team Nexperia

# DATA SHEET

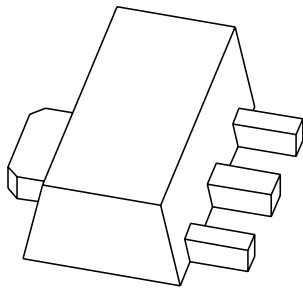

**PBSS4480X**

80 V, 4 A

NPN low  $V_{CEsat}$  (BISS) transistor

Product data sheet  
Supersedes data of 2004 Aug 5

2004 Oct 25

**80 V, 4 A**  
**NPN low  $V_{CEsat}$  (BISS) transistor**

**PBSS4480X**

**FEATURES**

- High  $h_{FE}$  and low  $V_{CEsat}$  at high current operation
- High collector current capability:  $I_C$  maximum 4 A
- High efficiency leading to less heat generation.

**APPLICATIONS**

- Medium power peripheral drivers; e.g. fan, motor
- Strobe flash units for DSC and mobile phones
- Inverter applications; e.g. TFT displays
- Power switch for LAN and ADSL systems
- Medium power DC-to-DC conversion
- Battery chargers.

**DESCRIPTION**

NPN low  $V_{CEsat}$  transistor in a SOT89 (SC-62) plastic package.  
 PNP complement: PBSS5480X.

**MARKING**

TYPE NUMBER	MARKING CODE <sup>(1)</sup>
PBSS4480X	*1Y

**Note**

1. \* = p: made in Hong Kong.  
 \* = t: made in Malaysia.  
 \* = W: made in China.

**QUICK REFERENCE DATA**

SYMBOL	PARAMETER	MAX.	UNIT
$V_{CEO}$	collector-emitter voltage	80	V
$I_C$	collector current (DC)	4	A
$I_{CM}$	peak collector current	10	A
$R_{CEsat}$	equivalent on-resistance	54	m $\Omega$

**PINNING**

PIN	DESCRIPTION
1	emitter
2	collector
3	base

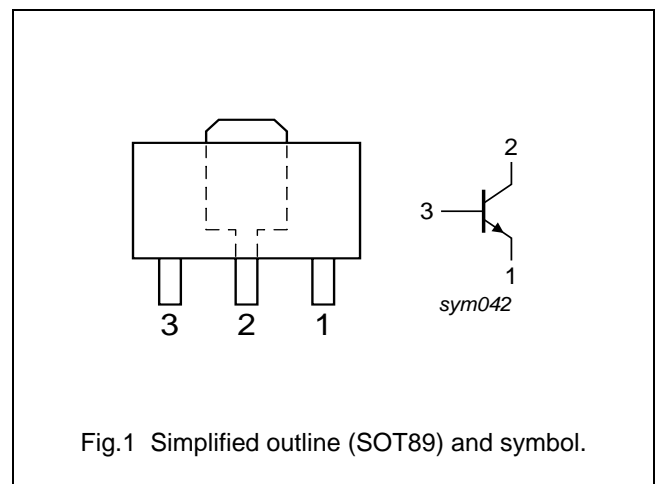

**ORDERING INFORMATION**

TYPE NUMBER	PACKAGE		
	NAME	DESCRIPTION	VERSION
PBSS4480X	–	plastic surface mounted package; collector pad for good heat transfer; 3 leads	SOT89

80 V, 4 A  
NPN low  $V_{CEsat}$  (BISS) transistor

PBSS4480X

**LIMITING VALUES**

In accordance with the Absolute Maximum Rating System (IEC 60134).

SYMBOL	PARAMETER	CONDITIONS	MIN.	MAX.	UNIT
$V_{CBO}$	collector-base voltage	open emitter	–	80	V
$V_{CEO}$	collector-emitter voltage	open base	–	80	V
$V_{EBO}$	emitter-base voltage	open collector	–	5	V
$I_C$	collector current (DC)	note 4	–	4	A
$I_{CRM}$	repetitive peak collector current	$t_p \leq 10$ ms; $\delta \leq 0.1$	–	6	A
$I_{CM}$	peak collector current	$t = 1$ ms or limited by $T_{j(max)}$	–	10	A
$I_B$	base current (DC)		–	1	A
$I_{BM}$	peak base current	$t \leq 300$ $\mu$ s	–	2	A
$P_{tot}$	total power dissipation	$T_{amb} \leq 25$ °C notes 1 and 2 note 2 note 3 note 4 note 5	–	2.5 550 1 1.4 1.6	W mW W W W
$T_j$	junction temperature		–	150	°C
$T_{amb}$	ambient temperature		–65	+150	°C
$T_{stg}$	storage temperature		–65	+150	°C

**Notes**

1. Operated under pulsed conditions; pulse width  $t_p \leq 10$  ms; duty cycle  $\delta \leq 0.2$ .
2. Device mounted on a printed-circuit board, single-sided copper, tin-plated and standard footprint.
3. Device mounted on a printed-circuit board, single-sided copper, tin-plated and mounting pad for collector 1 cm<sup>2</sup>.
4. Device mounted on a printed-circuit board, single-sided copper, tin-plated and mounting pad for collector 6 cm<sup>2</sup>.
5. Device mounted on a 7 cm<sup>2</sup> ceramic printed-circuit board, 1 cm<sup>2</sup> single-sided copper and tin-plated. For other mounting conditions, see “*Thermal considerations for SOT89 in the General Part of associated Handbook*”.

80 V, 4 A  
NPN low  $V_{CEsat}$  (BISS) transistor

PBSS4480X

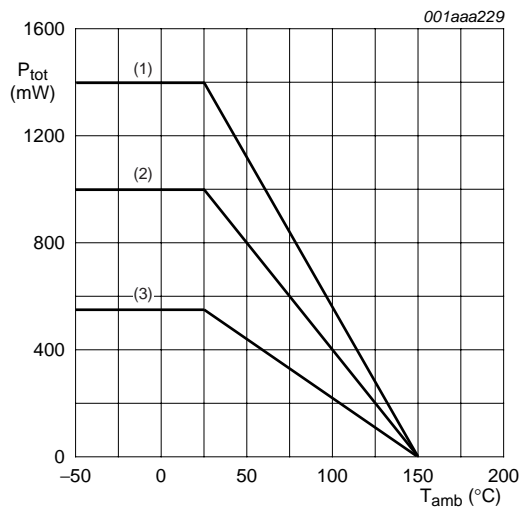

- (1) FR4 PCB; 6 cm<sup>2</sup> mounting pad for collector.
- (2) FR4 PCB; 1 cm<sup>2</sup> mounting pad for collector.
- (3) FR4; standard footprint.

Fig.2 Power derating curves.

80 V, 4 A  
NPN low  $V_{CEsat}$  (BISS) transistor

PBSS4480X

**THERMAL CHARACTERISTICS**

SYMBOL	PARAMETER	CONDITIONS	VALUE	UNIT
$R_{th(j-a)}$	thermal resistance from junction to ambient	in free air		
		notes 1 and 2	50	K/W
		note 2	225	K/W
		note 3	125	K/W
		note 4	90	K/W
	note 5	80	K/W	
$R_{th(j-s)}$	thermal resistance from junction to soldering point		16	K/W

**Notes**

1. Operated under pulsed conditions; pulse width  $t_p \leq 10$  ms; duty cycle  $\delta \leq 0.2$ .
2. Device mounted on a printed-circuit board, single-sided copper, tin-plated and standard footprint.
3. Device mounted on a printed-circuit board, single-sided copper, tin-plated and mounting pad for collector 1 cm<sup>2</sup>.
4. Device mounted on a printed-circuit board, single-sided copper, tin-plated and mounting pad for collector 6 cm<sup>2</sup>.
5. Device mounted on a 7 cm<sup>2</sup> ceramic printed-circuit board, 1 cm<sup>2</sup> single-sided copper and tin-plated. For other mounting conditions, see *“Thermal considerations for SOT89 in the General Part of associated Handbook”*.

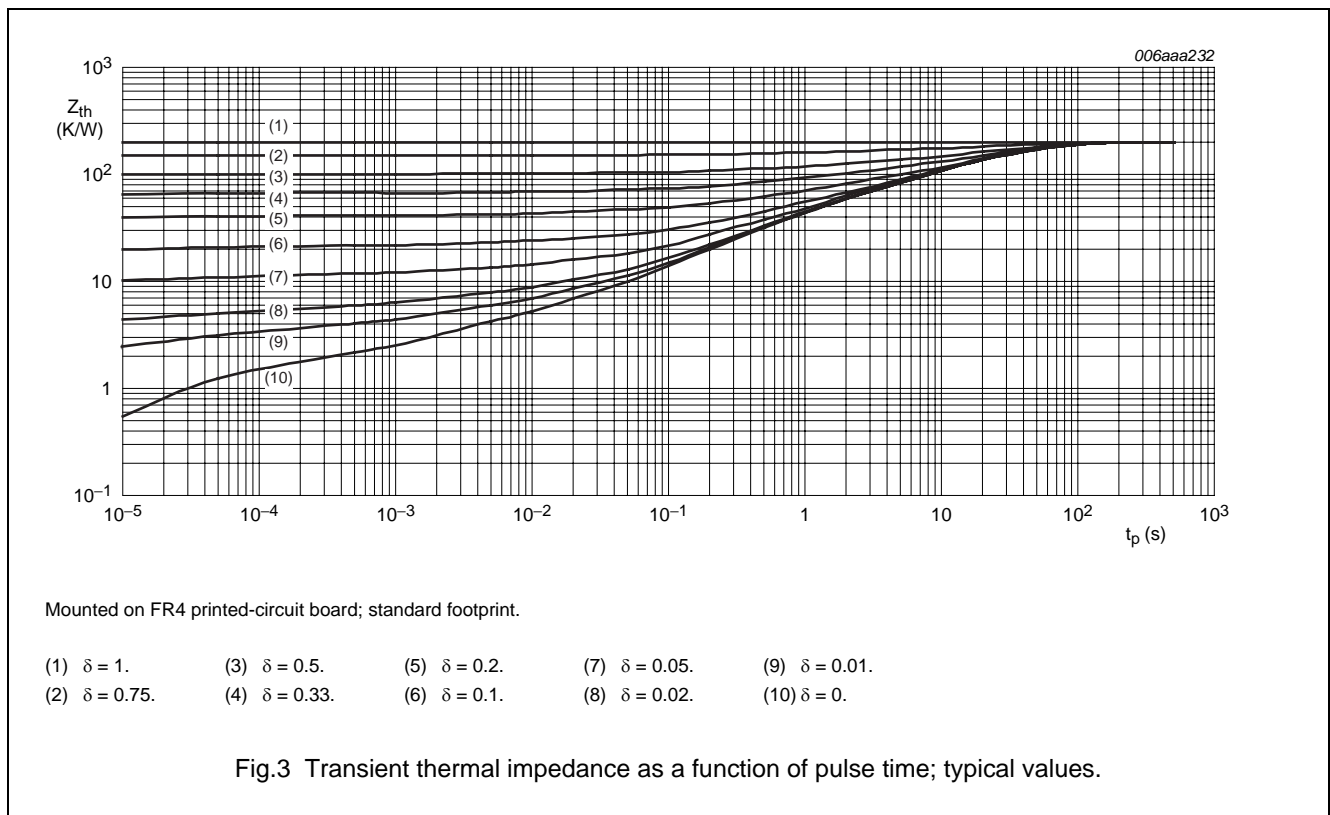

80 V, 4 A  
NPN low  $V_{CEsat}$  (BISS) transistor

PBSS4480X

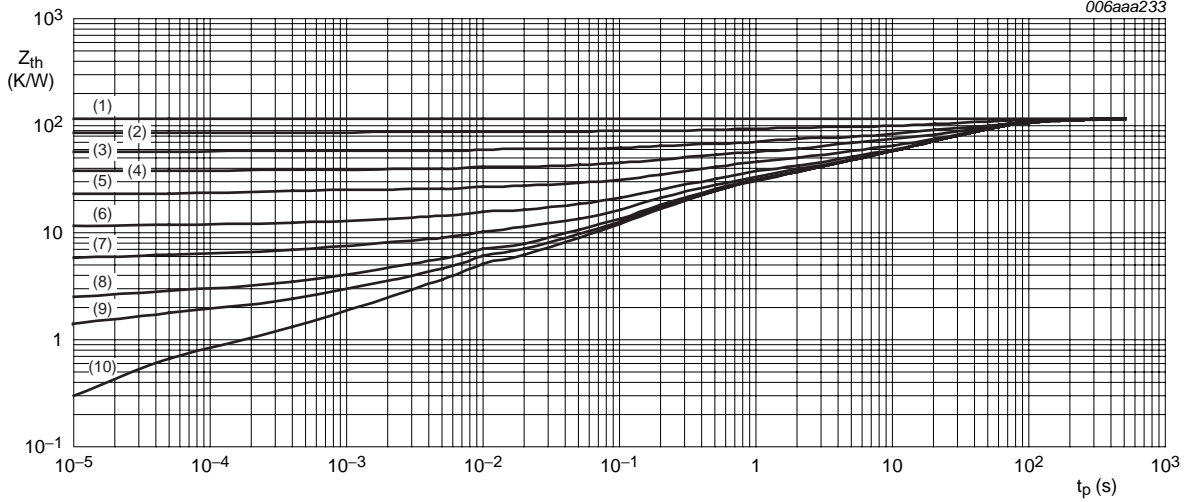

Mounted on FR4 printed-circuit board; mounting pad for collector 1 cm<sup>2</sup>.

- (1)  $\delta = 1.$       (3)  $\delta = 0.5.$       (5)  $\delta = 0.2.$       (7)  $\delta = 0.05.$       (9)  $\delta = 0.01.$
- (2)  $\delta = 0.75.$       (4)  $\delta = 0.33.$       (6)  $\delta = 0.1.$       (8)  $\delta = 0.02.$       (10)  $\delta = 0.$

Fig.4 Transient thermal impedance as a function of pulse time; typical values.

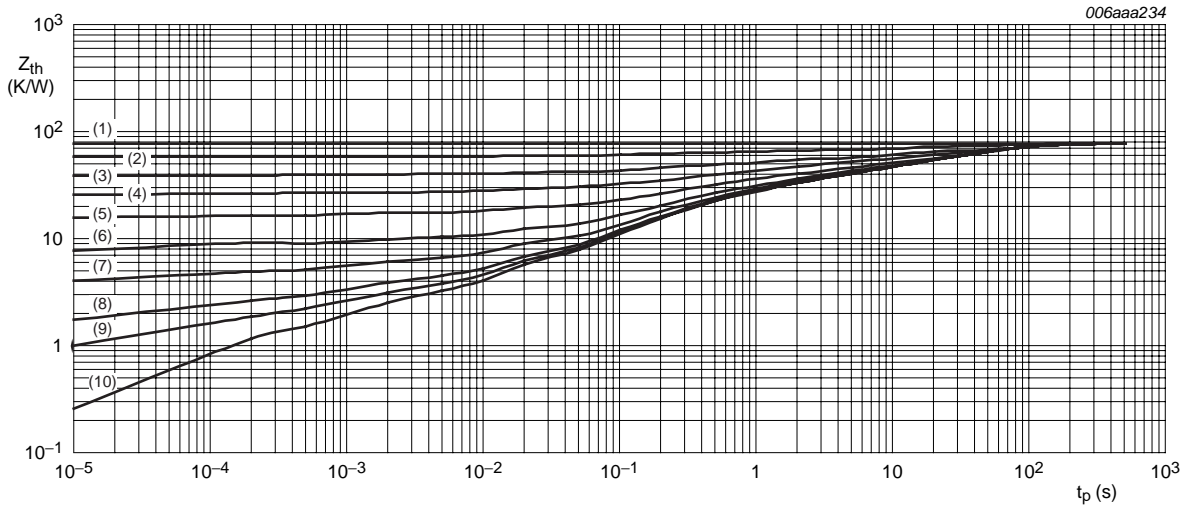

Mounted on FR4 printed-circuit board; mounting pad for collector 6 cm<sup>2</sup>.

- (1)  $\delta = 1.$       (3)  $\delta = 0.5.$       (5)  $\delta = 0.2.$       (7)  $\delta = 0.05.$       (9)  $\delta = 0.01.$
- (2)  $\delta = 0.75.$       (4)  $\delta = 0.33.$       (6)  $\delta = 0.1.$       (8)  $\delta = 0.02.$       (10)  $\delta = 0.$

Fig.5 Transient thermal impedance as a function of pulse time; typical values.

80 V, 4 A  
NPN low  $V_{CEsat}$  (BISS) transistor

PBSS4480X

**CHARACTERISTICS** $T_{amb} = 25\text{ °C}$  unless otherwise specified.

SYMBOL	PARAMETER	CONDITIONS	MIN.	TYP.	MAX.	UNIT
$I_{CBO}$	collector-base cut-off current	$V_{CB} = 80\text{ V}; I_E = 0\text{ A}$	–	–	100	nA
		$V_{CB} = 80\text{ V}; I_E = 0\text{ A}; T_j = 150\text{ °C}$	–	–	50	$\mu\text{A}$
$I_{CES}$	collector-emitter cut-off current	$V_{CE} = 80\text{ V}; V_{BE} = 0\text{ V}$	–	–	100	nA
$I_{EBO}$	emitter-base cut-off current	$V_{EB} = 5\text{ V}; I_C = 0\text{ A}$	–	–	100	nA
$h_{FE}$	DC current gain	$V_{CE} = 2\text{ V}; I_C = 0.5\text{ A}$	250	400	–	–
		$V_{CE} = 2\text{ V}; I_C = 1\text{ A};$ note 1	250	400	–	–
		$V_{CE} = 2\text{ V}; I_C = 2\text{ A};$ note 1	175	270	–	–
		$V_{CE} = 2\text{ V}; I_C = 4\text{ A};$ note 1	80	140	–	–
$V_{CEsat}$	collector-emitter saturation voltage	$I_C = 0.5\text{ A}; I_B = 50\text{ mA}$	–	25	40	mV
		$I_C = 1\text{ A}; I_B = 50\text{ mA}$	–	55	80	mV
		$I_C = 2\text{ A}; I_B = 40\text{ mA}$	–	110	160	mV
		$I_C = 4\text{ A}; I_B = 200\text{ mA};$ note 1	–	170	230	mV
		$I_C = 5\text{ A}; I_B = 500\text{ mA};$ note 1	–	200	270	mV
$R_{CEsat}$	equivalent on-resistance	$I_C = 5\text{ A}; I_B = 500\text{ mA};$ note 1	–	40	54	$\text{m}\Omega$
$V_{BEsat}$	base-emitter saturation voltage	$I_C = 0.5\text{ A}; I_B = 50\text{ mA}$	–	0.78	0.85	V
		$I_C = 1\text{ A}; I_B = 50\text{ mA}$	–	0.79	0.9	V
		$I_C = 1\text{ A}; I_B = 100\text{ mA};$ note 1	–	0.82	0.95	V
		$I_C = 4\text{ A}; I_B = 400\text{ mA};$ note 1	–	0.95	1.05	V
$V_{BEon}$	base-emitter turn-on voltage	$I_C = 2\text{ A}; V_{CE} = 2\text{ V}$	–	0.78	0.85	V
$f_T$	transition frequency	$I_C = 100\text{ mA}; V_{CE} = 10\text{ V};$ $f = 100\text{ MHz}$	120	150	–	MHz
$C_c$	collector capacitance	$I_E = I_e = 0\text{ A}; V_{CB} = 10\text{ V};$ $f = 1\text{ MHz}$	–	35	50	pF

**Note**1. Pulse test:  $t_p \leq 300\text{ }\mu\text{s}; \delta \leq 0.02$ .

80 V, 4 A  
NPN low  $V_{CEsat}$  (BISS) transistor

PBSS4480X

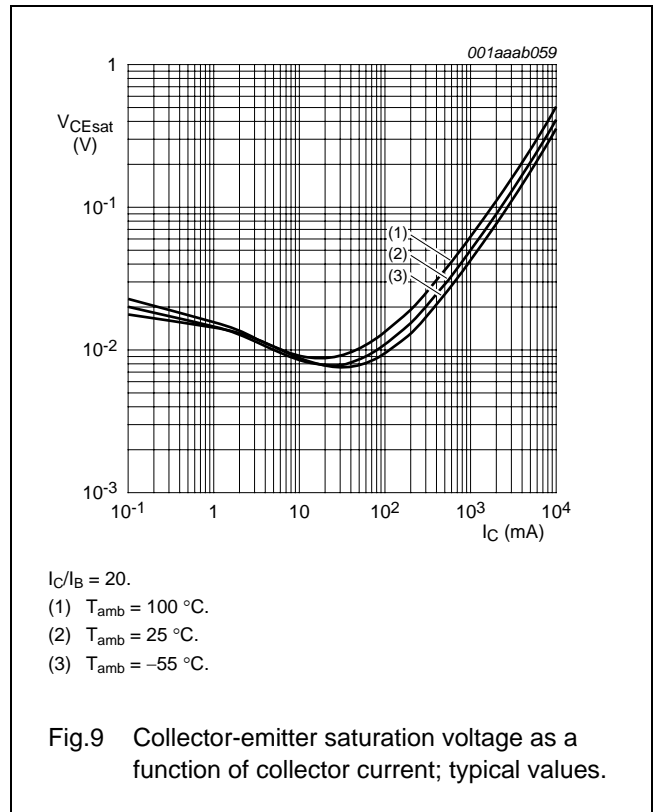
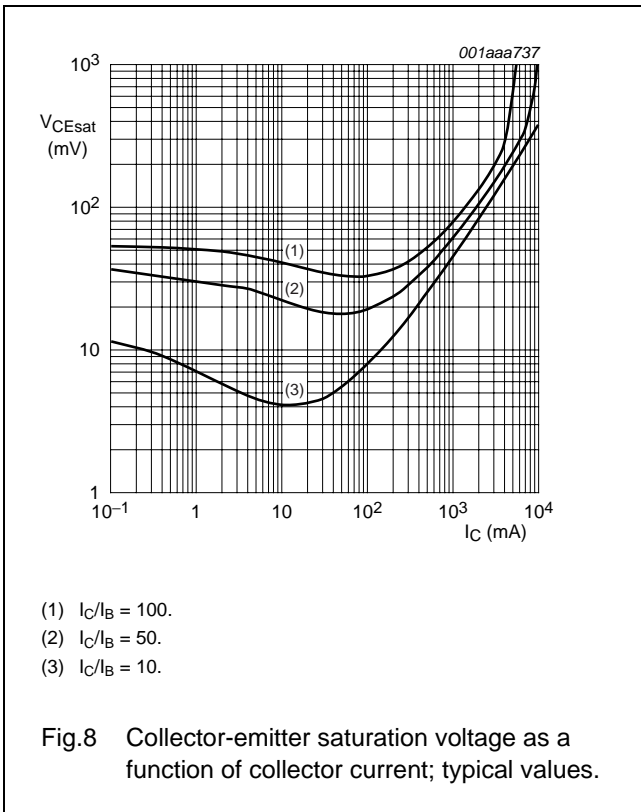
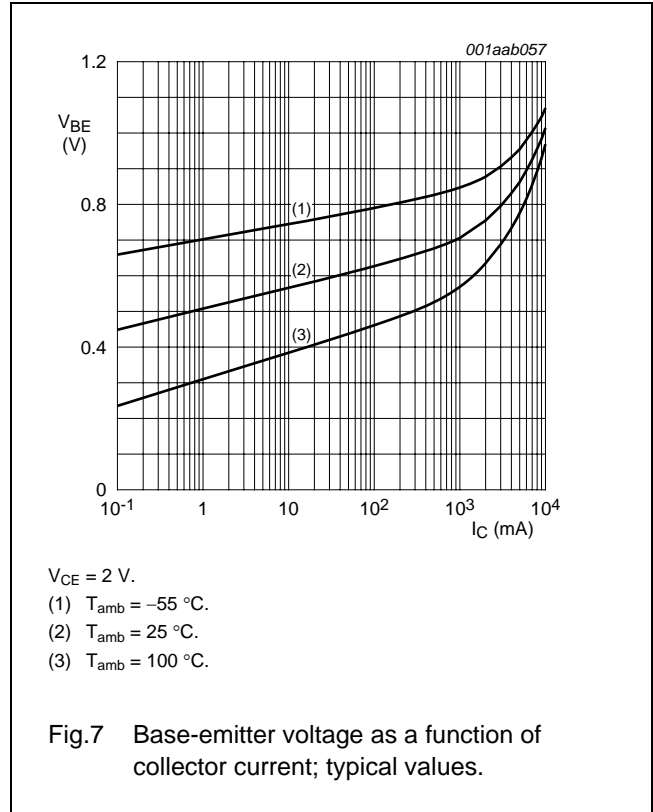
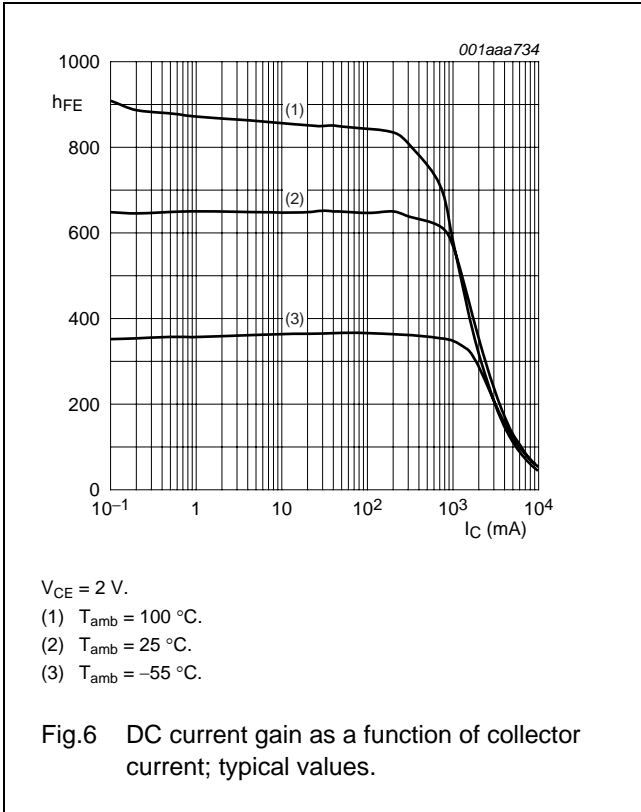

80 V, 4 A  
NPN low  $V_{CEsat}$  (BISS) transistor

PBSS4480X

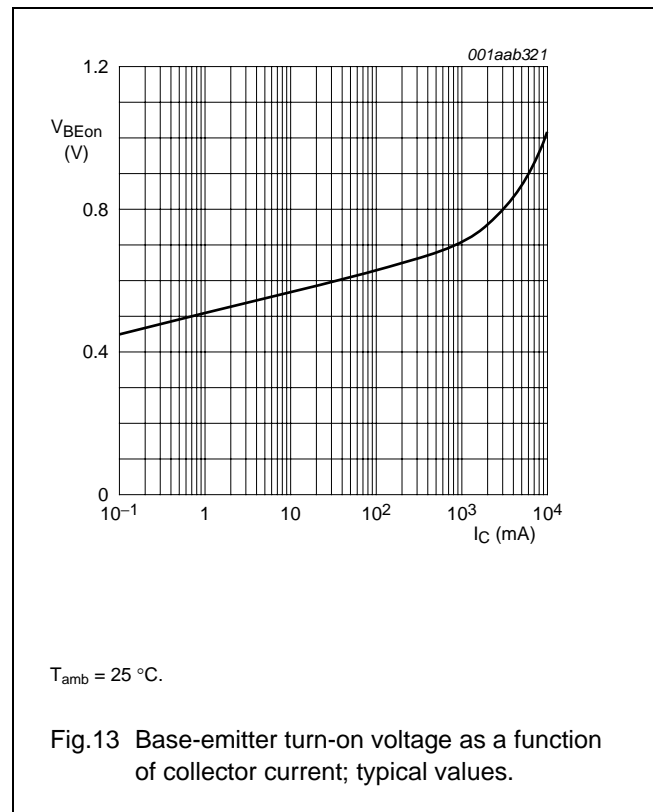
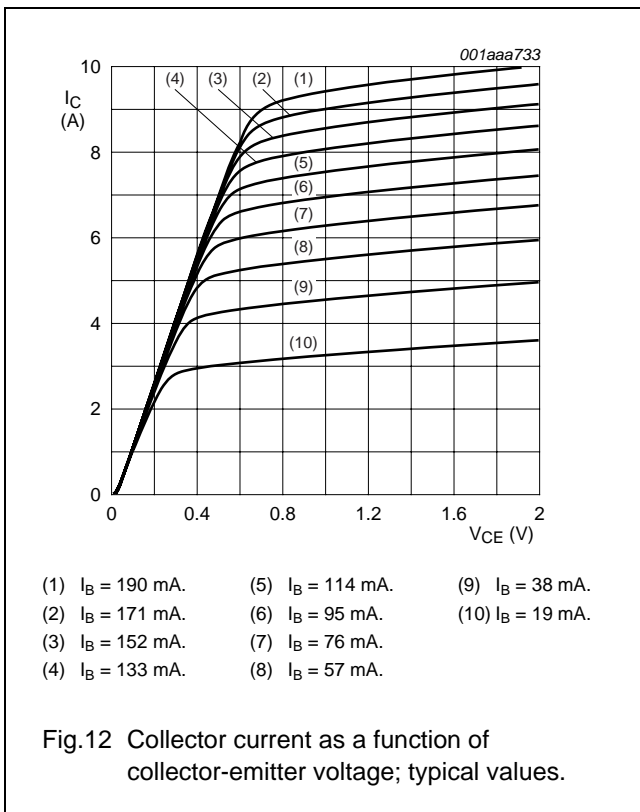
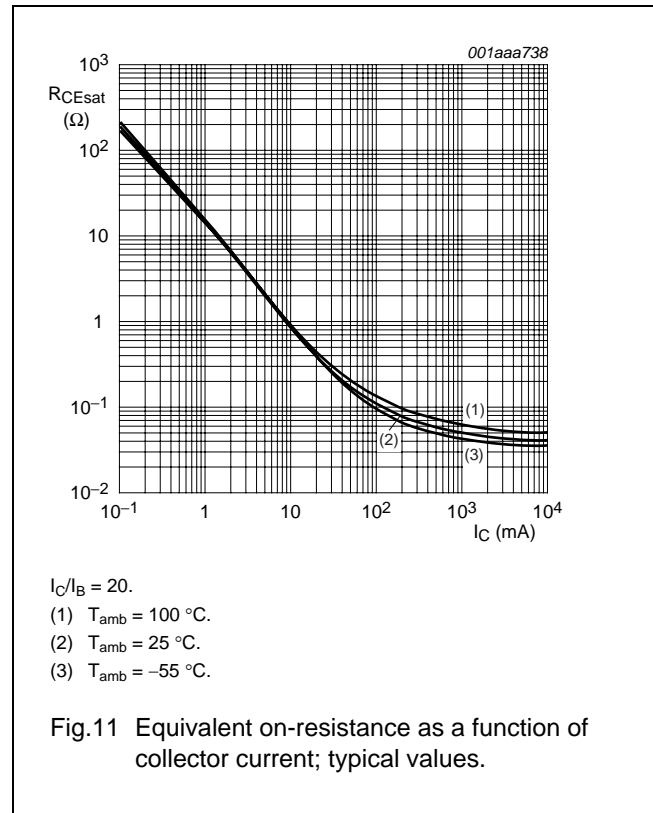
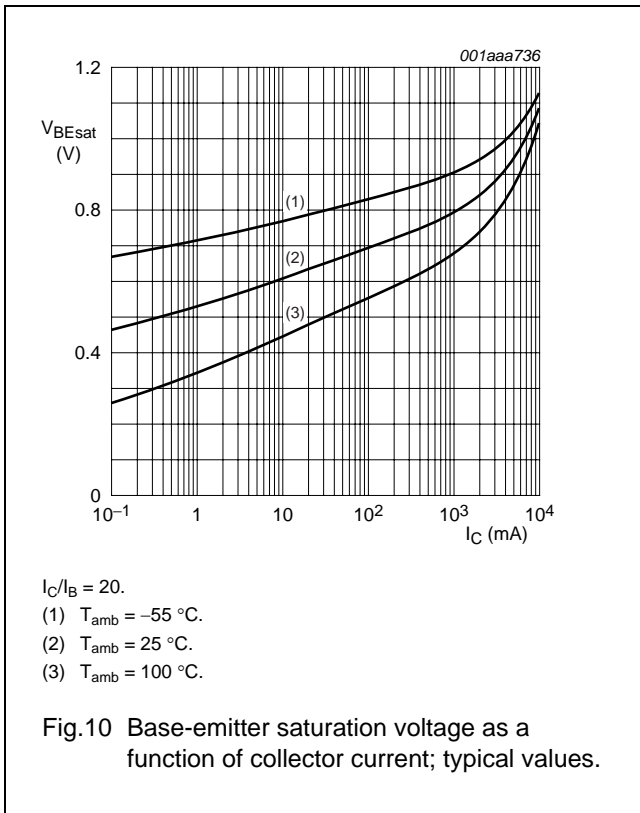



80 V, 4 A  
NPN low  $V_{CEsat}$  (BISS) transistor

PBSS4480X

PACKAGE OUTLINE

Plastic surface-mounted package; collector pad for good heat transfer; 3 leads

SOT89

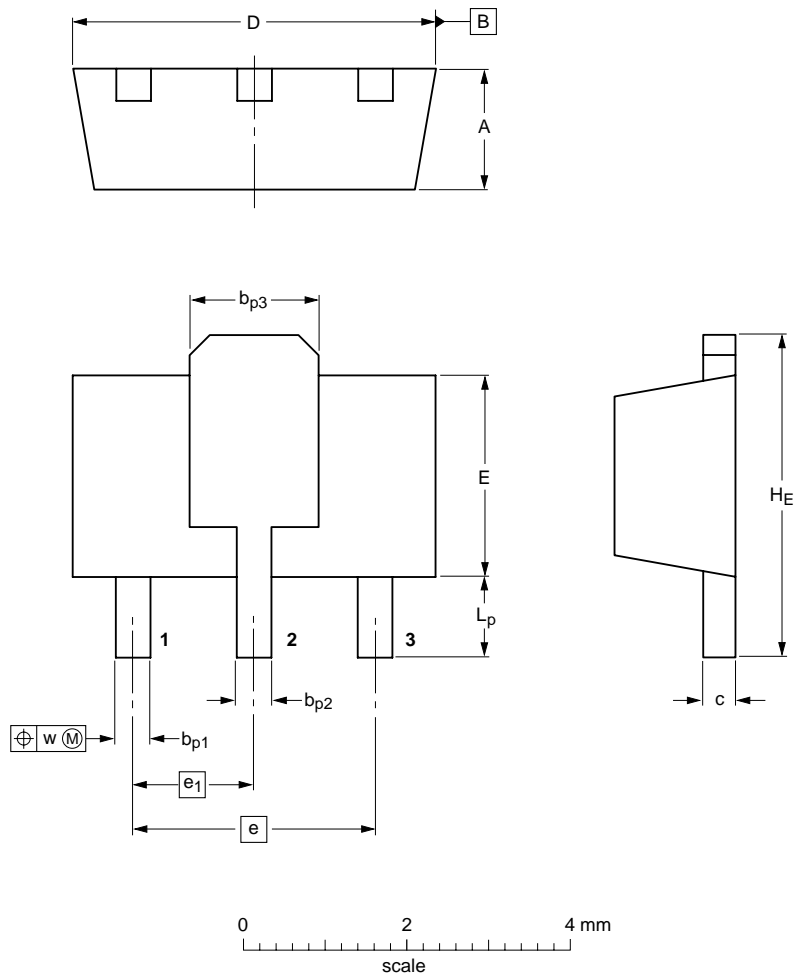

DIMENSIONS (mm are the original dimensions)

UNIT	A	b <sub>p1</sub>	b <sub>p2</sub>	b <sub>p3</sub>	c	D	E	e	e <sub>1</sub>	H <sub>E</sub>	L <sub>p</sub>	w
mm	1.6 1.4	0.48 0.35	0.53 0.40	1.8 1.4	0.44 0.23	4.6 4.4	2.6 2.4	3.0	1.5	4.25 3.75	1.2 0.8	0.13

OUTLINE VERSION	REFERENCES			EUROPEAN PROJECTION	ISSUE DATE
	IEC	JEDEC	JEITA		
SOT89		TO-243	SC-62		04-08-03 06-03-16

80 V, 4 A  
NPN low  $V_{CEsat}$  (BISS) transistor

PBSS4480X

**DATA SHEET STATUS**

DOCUMENT STATUS <sup>(1)</sup>	PRODUCT STATUS <sup>(2)</sup>	DEFINITION
Objective data sheet	Development	This document contains data from the objective specification for product development.
Preliminary data sheet	Qualification	This document contains data from the preliminary specification.
Product data sheet	Production	This document contains the product specification.

**Notes**

1. Please consult the most recently issued document before initiating or completing a design.
2. The product status of device(s) described in this document may have changed since this document was published and may differ in case of multiple devices. The latest product status information is available on the Internet at URL <http://www.nxp.com>.

**DISCLAIMERS**

**General** — Information in this document is believed to be accurate and reliable. However, NXP Semiconductors does not give any representations or warranties, expressed or implied, as to the accuracy or completeness of such information and shall have no liability for the consequences of use of such information.

**Right to make changes** — NXP Semiconductors reserves the right to make changes to information published in this document, including without limitation specifications and product descriptions, at any time and without notice. This document supersedes and replaces all information supplied prior to the publication hereof.

**Suitability for use** — NXP Semiconductors products are not designed, authorized or warranted to be suitable for use in medical, military, aircraft, space or life support equipment, nor in applications where failure or malfunction of an NXP Semiconductors product can reasonably be expected to result in personal injury, death or severe property or environmental damage. NXP Semiconductors accepts no liability for inclusion and/or use of NXP Semiconductors products in such equipment or applications and therefore such inclusion and/or use is at the customer's own risk.

**Applications** — Applications that are described herein for any of these products are for illustrative purposes only. NXP Semiconductors makes no representation or warranty that such applications will be suitable for the specified use without further testing or modification.

**Limiting values** — Stress above one or more limiting values (as defined in the Absolute Maximum Ratings System of IEC 60134) may cause permanent damage to the device. Limiting values are stress ratings only and operation of the device at these or any other conditions

above those given in the Characteristics sections of this document is not implied. Exposure to limiting values for extended periods may affect device reliability.

**Terms and conditions of sale** — NXP Semiconductors products are sold subject to the general terms and conditions of commercial sale, as published at <http://www.nxp.com/profile/terms>, including those pertaining to warranty, intellectual property rights infringement and limitation of liability, unless explicitly otherwise agreed to in writing by NXP Semiconductors. In case of any inconsistency or conflict between information in this document and such terms and conditions, the latter will prevail.

**No offer to sell or license** — Nothing in this document may be interpreted or construed as an offer to sell products that is open for acceptance or the grant, conveyance or implication of any license under any copyrights, patents or other industrial or intellectual property rights.

**Export control** — This document as well as the item(s) described herein may be subject to export control regulations. Export might require a prior authorization from national authorities.

**Quick reference data** — The Quick reference data is an extract of the product data given in the Limiting values and Characteristics sections of this document, and as such is not complete, exhaustive or legally binding.

# ***NXP Semiconductors***

## **Customer notification**

This data sheet was changed to reflect the new company name NXP Semiconductors, including new legal definitions and disclaimers. No changes were made to the technical content, except for package outline drawings which were updated to the latest version.

## **Contact information**

For additional information please visit: <http://www.nxp.com>

For sales offices addresses send e-mail to: [salesaddresses@nxp.com](mailto:salesaddresses@nxp.com)

© NXP B.V. 2009

All rights are reserved. Reproduction in whole or in part is prohibited without the prior written consent of the copyright owner.

The information presented in this document does not form part of any quotation or contract, is believed to be accurate and reliable and may be changed without notice. No liability will be accepted by the publisher for any consequence of its use. Publication thereof does not convey nor imply any license under patent- or other industrial or intellectual property rights.

Printed in The Netherlands

R75/02/pp13



Date of release: 2004 Oct 25

Document order number: 9397 750 13924



## Looking for pricing, stock, or lifecycle information?

Click below to explore more details on WIN SOURCE:

-  [View PBSS4480X,135 on WIN SOURCE](#)
-  [Nexperia USA Inc. Information](#)

## Optimize Your Supply Chain with WIN SOURCE Solutions

-  Global Sourcing Solution
-  Obsolete Management
-  Cost Control Management
-  Shortage Management
-  Alternative Solution
-  Excess Inventory Management