



**THE DATASHEET OF
NCP600SN130T1G**



NCP600

High Performance Low-Power, LDO Regulator with Enable

The NCP600 provides 150 mA of output current at fixed voltage options, or an adjustable output voltage from 5.0 V down to 1.25 V. It is designed for portable battery powered applications and offers high performance features such as low power operation, fast enable response time, and low dropout.

The device is designed to be used with low cost ceramic capacitors and is packaged in the TSOP-5 and DFN6, 2x2.2 packages.

Features

- Output Voltage Options:
Adjustable, 1.3 V, 1.5 V, 1.8 V, 2.5 V, 2.8 V, 3.0 V, 3.3 V, 3.5 V, 5.0 V
- Ultra-Low Dropout Voltage of 150 mV at 150 mA
- Adjustable Output by External Resistors from 5.0 V down to 1.25 V
- Fast Enable Turn-on Time of 15 μ s
- Wide Supply Voltage Range Operating Range
- Excellent Line and Load Regulation
- High Accuracy up to 1.5% Output Voltage Tolerance over All Operating Conditions
- Typical Noise Voltage of 50 μ V_{rms} without a Bypass Capacitor
- Pb-Free Package is Available

Typical Applications

- SMPS Post-Regulation
- Hand-held Instrumentation
- Noise Sensitive Circuits – VCO, RF Stages, etc.
- Camcorders and Cameras

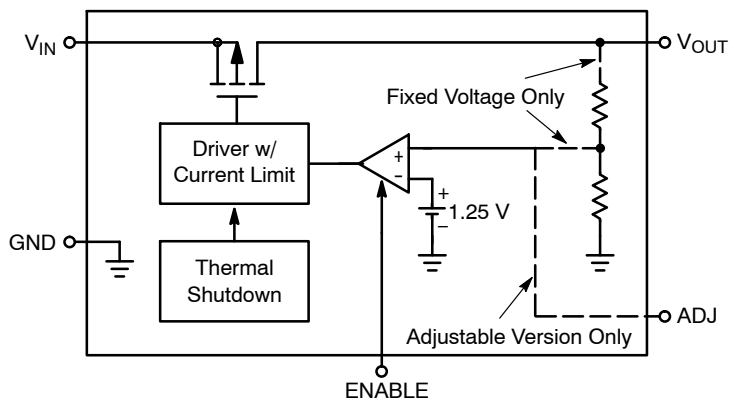

Figure 1. Simplified Block Diagram



ON Semiconductor®

<http://onsemi.com>

MARKING DIAGRAMS



TSOP-5
SN SUFFIX
CASE 483

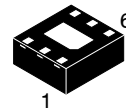
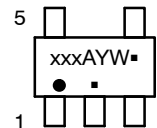

6 PIN DFN, 2x2.2
MN SUFFIX
CASE 506BA



XX = Specific Device Code
xxx = Specific Device Code
M = Date Code
A = Assembly Location
Y = Year
▪ = Pb-Free Package

(Note: Microdot may be in either location)

ORDERING INFORMATION

See detailed ordering and shipping information in the package dimensions section on page 13 of this data sheet.

NCP600

PIN CONNECTIONS

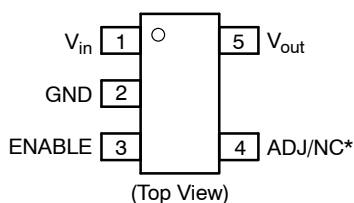

(Top View)
 * ADJ – Adjustable Version
 NC – Fixed Voltage Version

Figure 2. Pin Connections – TSOP5

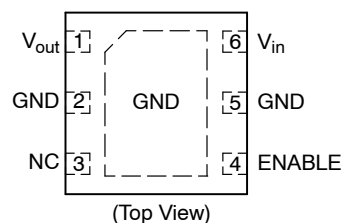

(Top View)

Figure 3. Pin Connections – DFN6

PIN FUNCTION DESCRIPTION

| Pin No. | | Pin Name | Description |
|------------|--------|-----------|--|
| DFN6 | TSOP-5 | | |
| 3 | 4 | ADJ/NC | Output Voltage Adjust Input (Adjustable Version), No Connection (Fixed Voltage Versions) (Note 1) |
| 2, 5, EPAD | 2 | GND | Power Supply Ground; Device Substrate |
| 4 | 3 | ENABLE | The Enable Input places the device into low-power standby when pulled to logic low (< 0.4 V). Connect to V_{in} if the function is not used. |
| 6 | 1 | V_{in} | Positive Power Supply Input |
| 1 | 5 | V_{out} | Regulated Output Voltage |

1. True no connect. Printed circuit board traces are allowable.

ABSOLUTE MAXIMUM RATINGS

| Rating | Symbol | Value | Unit |
|---|-------------------------|--|------|
| Input Voltage Range (Note 2) | V_{in} | -0.3 to 6.5 | V |
| Output, Enable, Adjustable Voltage Range | V_{out} , ENABLE, ADJ | -0.3 to 6.5 (or $V_{in} + 0.3$) Whichever is Lower | V |
| Maximum Junction Temperature | $T_{J(max)}$ | 150 | °C |
| Storage Temperature Range | T_{STG} | -65 to 150 | °C |
| ESD Capability, Human Body Model (Note 3) | ESD _{HBM} | 3500 | V |
| ESD Capability, Machine Model (Note 3) | ESD _{MM} | 200 | V |
| Moisture Sensitivity Level | MSL | MSL1/260 | - |

Stresses exceeding Maximum Ratings may damage the device. Maximum Ratings are stress ratings only. Functional operation above the Recommended Operating Conditions is not implied. Extended exposure to stresses above the Recommended Operating Conditions may affect device reliability.

2. Refer to ELECTRICAL CHARACTERISTICS and APPLICATION INFORMATION for Safe Operating Area.

3. This device series incorporates ESD protection and is tested by the following methods:

ESD Human Body Model tested per AEC-Q100-002 (EIA/JESD22-A114)

ESD Machine Model tested per AEC-Q100-003 (EIA/JESD22-A115)

Latchup Current Maximum Rating: ≤ 150 mA per JEDEC standard: JESD78.

THERMAL CHARACTERISTICS

| Rating | Symbol | Value | Unit |
|--|-----------------|-------|------|
| Thermal Characteristics, DFN6, 2x2.2 mm (Note 4) Thermal Resistance, Junction-to-Air (Note 5) | $R_{\theta JA}$ | 122 | °C/W |
| Thermal Characteristics, TSOP-5 (Note 4) Thermal Resistance, Junction-to-Air (Note 5) | $R_{\theta JA}$ | 215 | °C/W |

4. Refer to ELECTRICAL CHARACTERISTICS and APPLICATION INFORMATION for Safe Operating Area.

5. Values based on copper area of 645 mm², 1 oz copper thickness.

OPERATING RANGES (Note 6)

| Rating | Symbol | Min | Max | Unit |
|---|-----------|--------|-----|------|
| Operating Input Voltage (Note 7) | V_{in} | 1.75 V | 6 | V |
| Adjustable Output Voltage (Adjustable Version Only) | V_{out} | 1.25 | 5.0 | V |
| Output Current | I_{out} | 0 | 150 | mA |
| Ambient Temperature | T_A | -40 | 125 | °C |

6. Refer to ELECTRICAL CHARACTERISTICS and APPLICATION INFORMATION for Safe Operating Area.

7. Minimum $V_{in} = 1.75$ V or ($V_{out} + V_{DO}$), whichever is higher.

NCP600

ELECTRICAL CHARACTERISTICS ($V_{in} = 1.750\text{ V}$, $V_{out} = 1.250\text{ V}$, $C_{in} = C_{out} = 1.0\ \mu\text{F}$, for typical values $T_A = 25^\circ\text{C}$, for min/max values $T_A = -40^\circ\text{C}$ to 125°C , unless otherwise specified.) (Note 8)

| Characteristic | Symbol | Test Conditions | Min | Typ | Max | Unit |
|---|---------------------|--|----------------------------|---------------------------------------|--|---------------------|
| Regulator Output (Adjustable Voltage Version) | | | | | | |
| Output Voltage | V_{out} | $I_{out} = 1.0\text{ mA to }150\text{ mA}$ $V_{in} = 1.75\text{ V to }6.0\text{ V}$, $V_{out} = \text{ADJ}$ | 1.231 (-1.5%) | 1.250 | 1.269 (+1.5%) | V |
| Power Supply Ripple Rejection ($V_{in} = V_{out} + 1.0\text{ V} + 0.5\text{ V}_{p-p}$) | PSRR | $I_{out} = 1.0\text{ mA to }150\text{ mA}$ $f = 120\text{ Hz}$ $f = 1.0\text{ kHz}$ $f = 10\text{ kHz}$ | - - - | 62 55 38 | - - - | dB |
| Line Regulation | Reg _{line} | $V_{in} = 1.750\text{ V to }6.0\text{ V}$, $I_{out} = 1.0\text{ mA}$ | - | 1.0 | 10 | mV |
| Load Regulation | Reg _{load} | $I_{out} = 1.0\text{ mA to }150\text{ mA}$ | - | 2.0 | 15 | mV |
| Output Noise Voltage (Note 9) | V_n | $f = 10\text{ Hz to }100\text{ kHz}$ | - | 50 | - | μV_{rms} |
| Output Short Circuit Current | I_{sc} | $V_{out} = 0\text{ V}$ | 300 | 550 | 800 | mA |
| Dropout Voltage 1.25 V 1.3 V 1.5 V 1.8 V 2.5 V 2.8 V to 5.0 V | V_{DO} | Measured at: $V_{out} - 2.0\%$, $I_{out} = 150\text{ mA}$ | - - - - - - | 175 175 150 125 100 75 | 250 250 225 175 150 125 | mV |

Regulator Output (Fixed Voltage Version) ($V_{in} = V_{out} + 0.5\text{ V}$, $C_{in} = C_{out} = 1.0\ \mu\text{F}$, for typical values $T_A = 25^\circ\text{C}$, for min/max values $T_A = -40^\circ\text{C}$ to 125°C ; unless otherwise noted.) (Notes 8)

| | | | | | | |
|--|---------------------|--|--|-------------------------------|--|---------------------|
| Output Voltage 1.3 V 1.5 V 1.8 V 2.5 V 2.8 V 3.0 V 3.3 V 3.5 V 5.0 V | V_{out} | $I_{out} = 1.0\text{ mA to }150\text{ mA}$ $V_{in} = (V_{out} + 0.5\text{ V})\text{ to }6.0\text{ V}$ | 1.274 1.470 1.764 2.450 2.744 2.940 3.234 3.430 4.900 (-2%) | | 1.326 1.530 1.836 2.550 2.856 3.060 3.366 3.570 5.100 (+2%) | V |
| Power Supply Ripple Rejection (Note 9) ($V_{in} = V_{out} + 1.0\text{ V} + 0.5\text{ V}_{p-p}$) | PSRR | $I_{out} = 1.0\text{ mA to }150\text{ mA}$ $f = 120\text{ Hz}$ $f = 1.0\text{ kHz}$ $f = 10\text{ kHz}$ | - - - | 62 55 38 | - - - | dB |
| Line Regulation | Reg _{line} | $V_{in} = 1.750\text{ V to }6.0\text{ V}$, $I_{out} = 1.0\text{ mA}$ | - | 1.0 | 10 | mV |
| Load Regulation 1.3 V to 1.5 V 1.8 V 2.5 V to 5.0 V | Reg _{load} | $I_{out} = 1.0\text{ mA to }150\text{ mA}$ | - - - | 2.0 2.0 2.0 | 20 25 30 | mV |
| Output Noise Voltage (Note 9) | V_n | $f = 10\text{ Hz to }100\text{ kHz}$ | - | 50 | - | μV_{rms} |
| Output Short Circuit Current | I_{sc} | $V_{out} = 0\text{ V}$ | 300 | 550 | 800 | mA |
| Dropout Voltage 1.3 V 1.5 V 1.8 V 2.5 V 2.8 V to 5.0 V | V_{DO} | Measured at: $V_{out} - 2.0\%$ | - - - - - | 175 150 125 85 75 | 250 225 175 175 125 | mV |

8. Performance guaranteed over the indicated operating temperature range by design and/or characterization, production tested at $T_J = T_A = 25^\circ\text{C}$. Low duty cycle pulse techniques are used during testing to maintain the junction temperature as close to ambient as possible.
9. Values based on design and/or characterization.

NCP600

ELECTRICAL CHARACTERISTICS ($V_{in} = V_{out} + 0.5\text{ V}$, For Typical Values $T_A = 25^\circ\text{C}$, For Min/Max Values $T_A = -40^\circ\text{C}$ to 125°C , unless otherwise specified.) (Note 10)

| Characteristic | Symbol | Test Conditions | Min | Typ | Max | Unit |
|---|--------------|--|-----------------------|---------------------------------|---------------------------------|------------------|
| General | | | | | | |
| Disable Current | I_{DIS} | ENABLE = 0 V, $V_{in} = 6\text{ V}$ $T_A = -40^\circ\text{C}$ to 85°C | – | 0.01 | 1.0 | μA |
| Ground Current 1.25 V (Adjustable) 1.3 V 1.5 V 1.8 V to 3.0 V 3.3 V to 5.0 V | I_{GND} | ENABLE = 0.9 V, $I_{out} = 1.0\text{ mA}$ to 150 mA | – – – – – | 100 135 135 140 145 | 135 150 170 175 180 | μA |
| Thermal Shutdown Temperature (Note 11) | T_{SD} | | – | 175 | – | $^\circ\text{C}$ |
| Thermal Shutdown Hysteresis (Note 11) | T_{SH} | | – | 10 | – | $^\circ\text{C}$ |
| ADJ Input Bias Current | I_{ADJ} | | –0.75 | – | 0.75 | μA |
| Chip Enable | | | | | | |
| ENABLE Input Threshold Voltage Voltage Increasing, Logic High Voltage Decreasing, Logic Low | $V_{th(EN)}$ | | 0.9 – | – – | – 0.4 | V |
| Enable Input Bias Current (Note 11) | I_{EN} | | – | 3.0 | 100 | nA |
| Timing | | | | | | |
| Output Turn On Time (Note 11) 1.25 V 1.3 V to 3.5 V 5.0 V | t_{EN} | ENABLE = 0 V to V_{in} | – – – | 15 15 30 | 25 25 50 | μs |

10. Performance guaranteed over the indicated operating temperature range by design and/or characterization, production tested at $T_J = T_A = 25^\circ\text{C}$. Low duty cycle pulse techniques are used during testing to maintain the junction temperature as close to ambient as possible.
 11. Values based on design and/or characterization.

NCP600

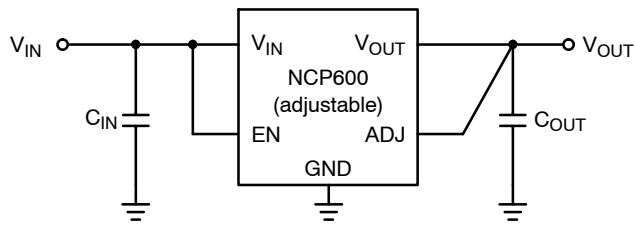

Figure 4. Typical Application Circuit for $V_{OUT} = 1.25\text{ V}$
(Adjustable Version)

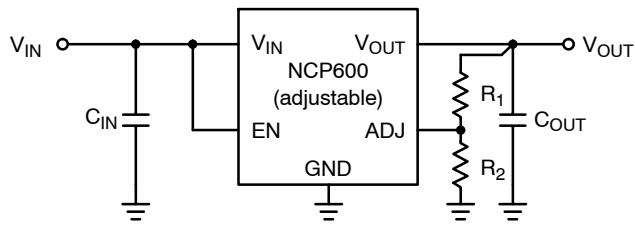

Figure 5. Typical Application Circuit for Adjustable V_{OUT}

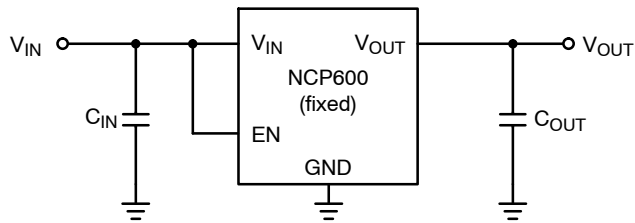

Figure 6. Typical Application Circuit
(Fixed Voltage Version)

NCP600

TYPICAL CHARACTERISTICS

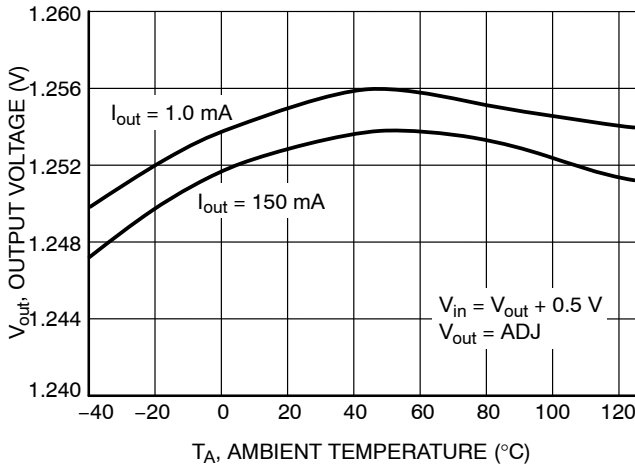

Figure 7. Output Voltage vs. Temperature
($V_{in} = V_{out} + 0.5 V$)

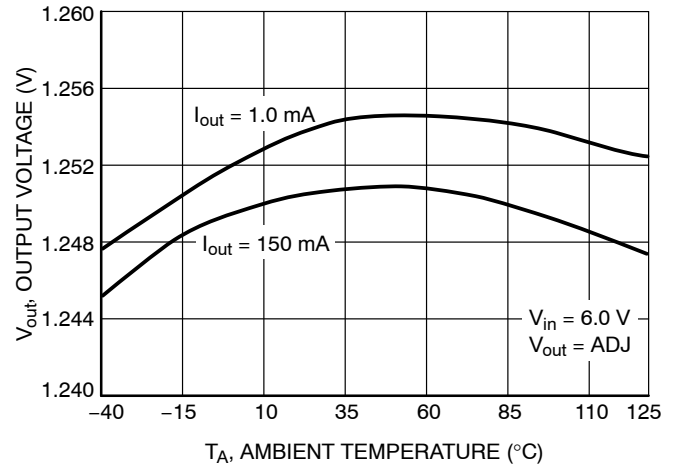

Figure 8. Output Voltage vs. Temperature
($V_{in} = 6.0 V$)

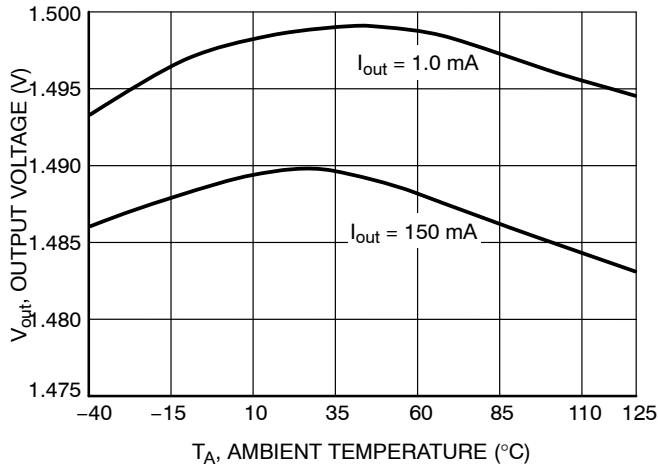

Figure 9. Output Voltage vs. Temperature
(1.5 V Fixed Output, $V_{in} = 2 V$)

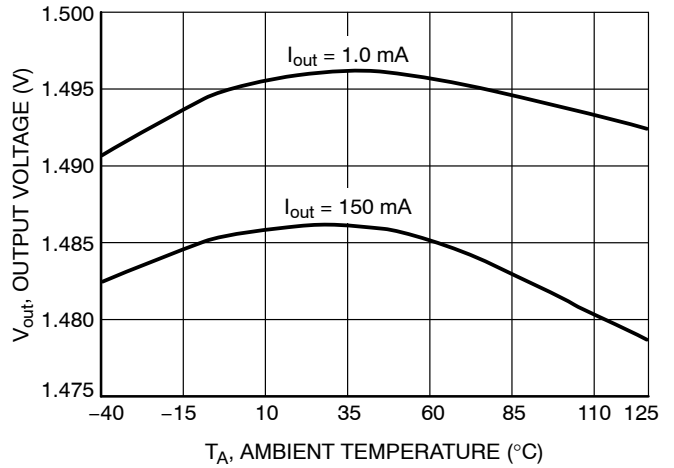

Figure 10. Output Voltage vs. Temperature
(1.5 V Fixed Output, $V_{in} = 6 V$)

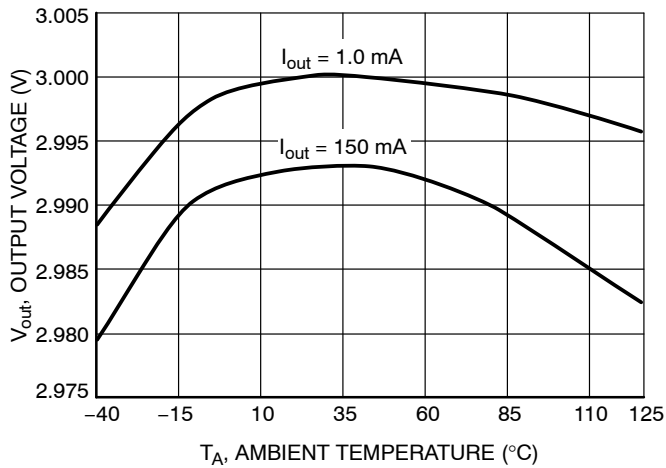

Figure 11. Output Voltage vs. Temperature
(3.0 V Fixed Output, $V_{in} = 3.5 V$)

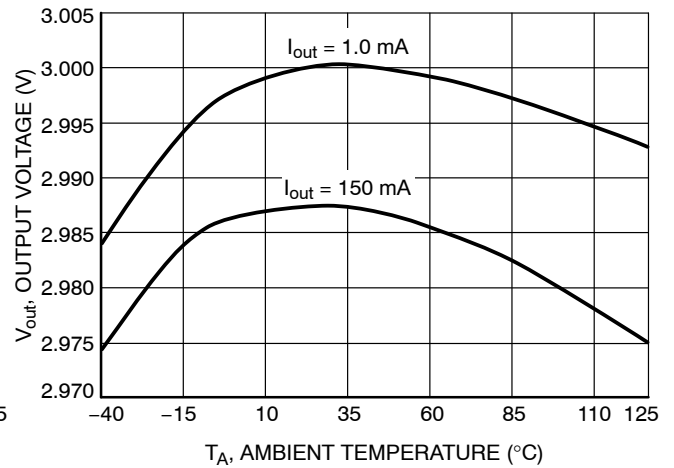

Figure 12. Output Voltage vs. Temperature
(3.0 V Fixed Output, $V_{in} = 6 V$)

NCP600

TYPICAL CHARACTERISTICS

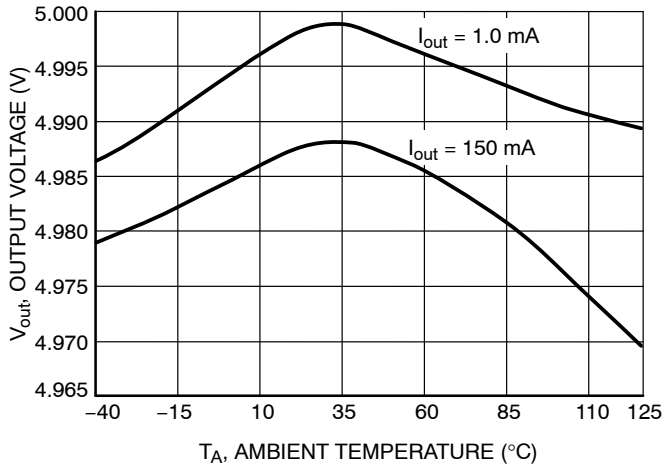

Figure 13. Output Voltage vs. Temperature (5.0 V Fixed Output, $V_{in} = 5.5$ V)

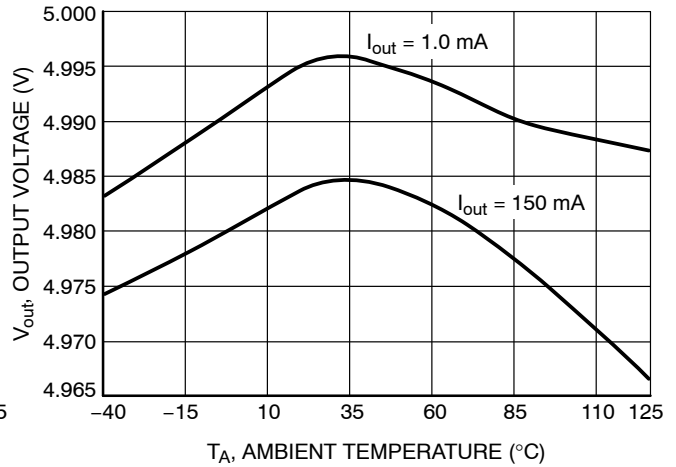

Figure 14. Output Voltage vs. Temperature (5.0 V Fixed Output, $V_{in} = 6$ V)

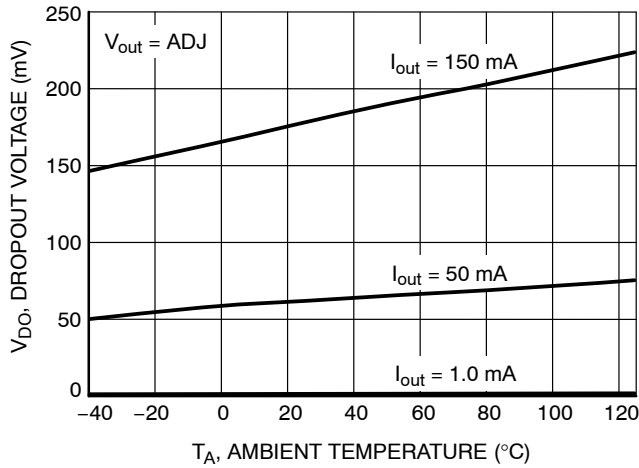

Figure 15. Dropout Voltage vs. Temperature (Over Current Range)

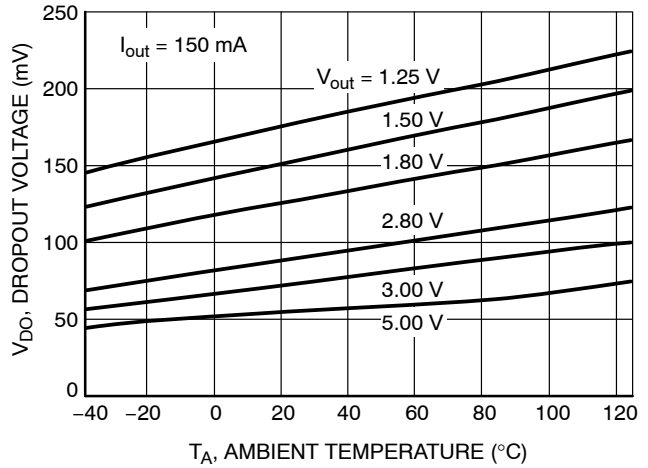

Figure 16. Dropout Voltage vs. Temperature (Over Output Voltage)

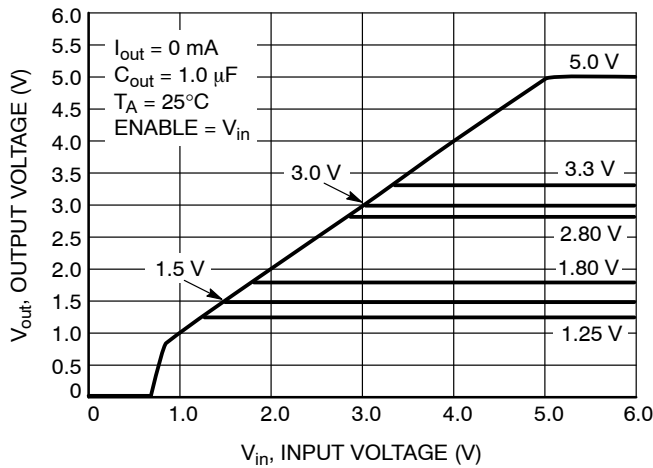

Figure 17. Output Voltage vs. Input Voltage

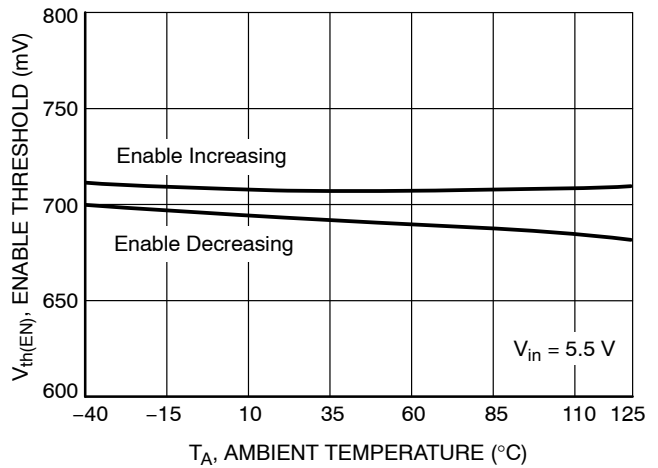

Figure 18. Enable Threshold vs. Temperature

NCP600

TYPICAL CHARACTERISTICS

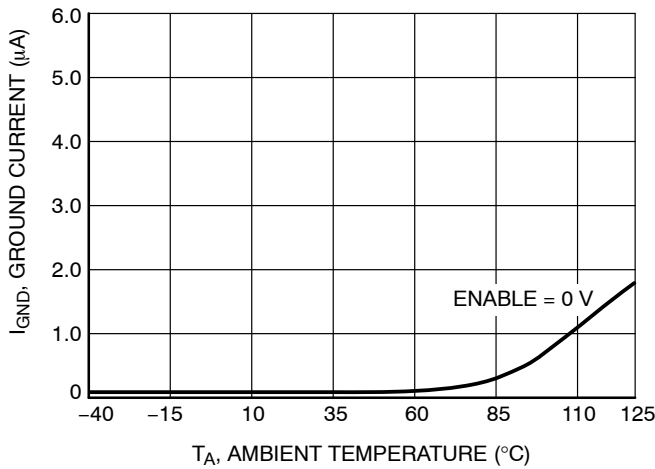

Figure 19. Ground Current (Sleep Mode) vs. Temperature

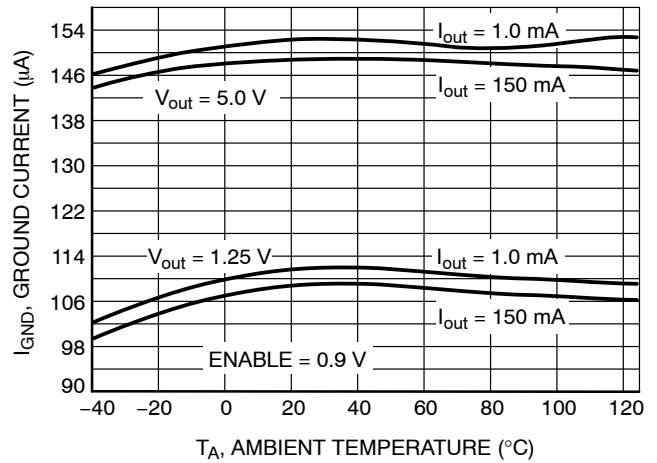

Figure 20. Ground Current (Run Mode) vs. Temperature

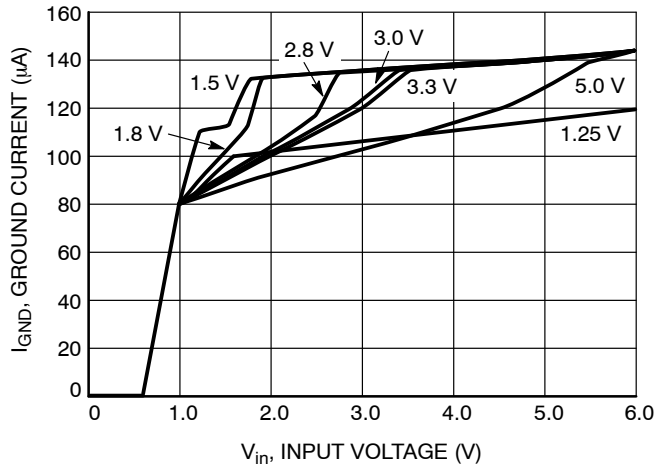

Figure 21. Ground Current vs. Input Voltage

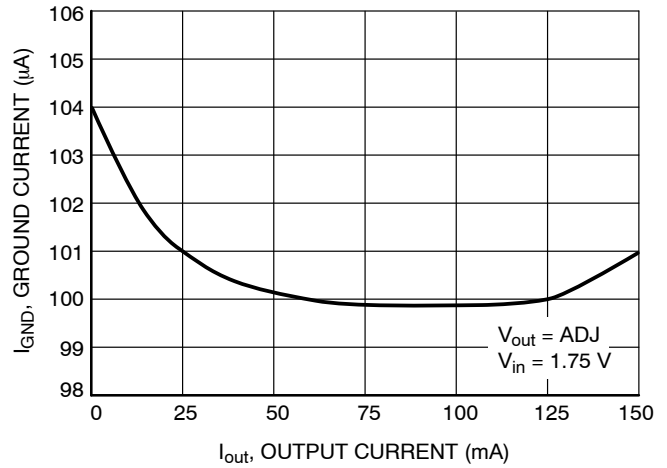

Figure 22. Ground Current vs. Output Current

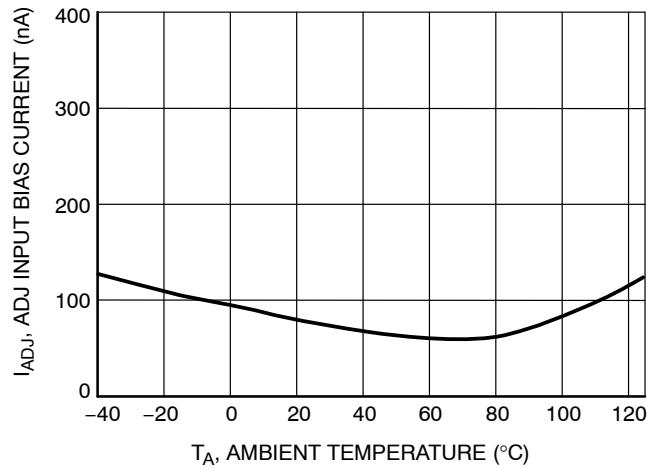

Figure 23. ADJ Input Bias Current vs. Temperature

NCP600

TYPICAL CHARACTERISTICS

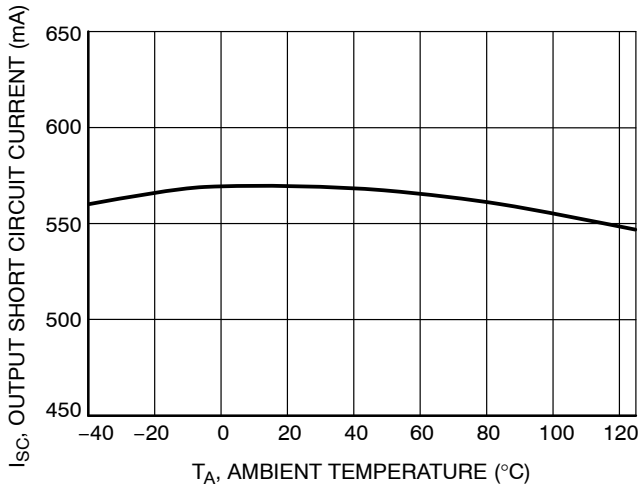

Figure 24. Output Short Circuit Current vs. Temperature

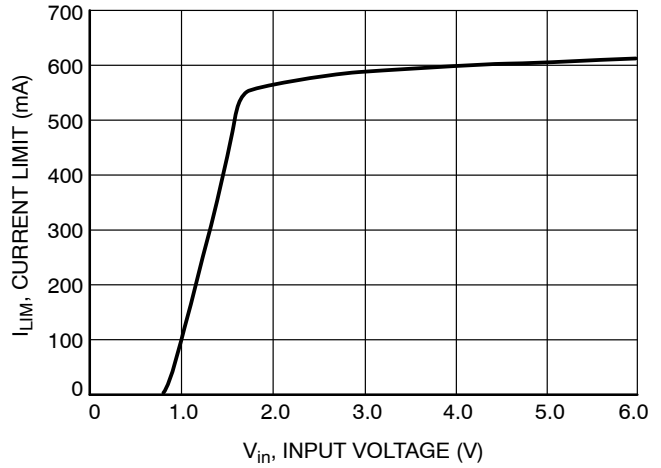

Figure 25. Current Limit vs. Input Voltage

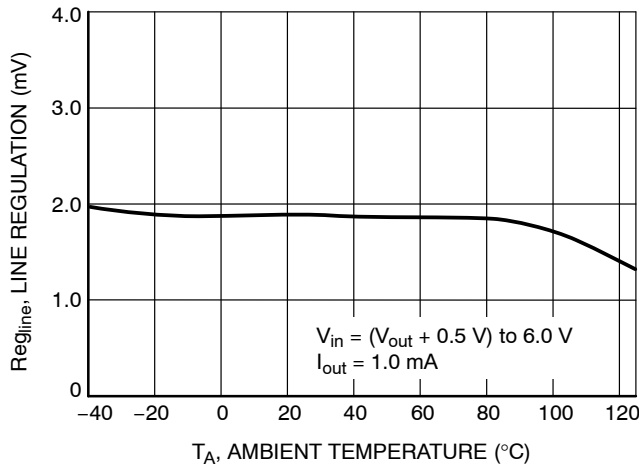

Figure 26. Line Regulation vs. Temperature

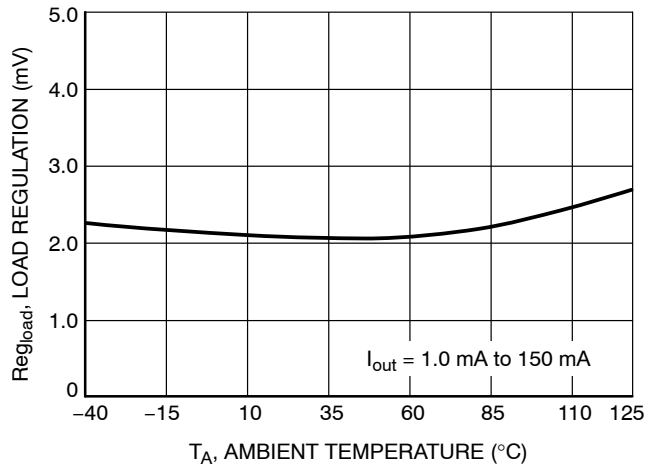

Figure 27. Load Regulation vs. Temperature

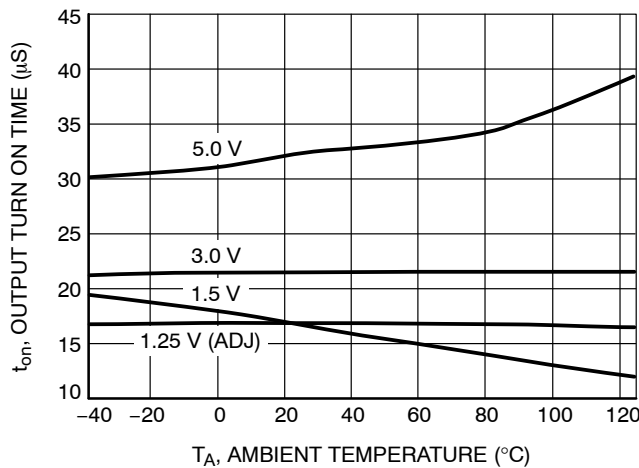

Figure 28. Output Turn On Time vs. Temperature

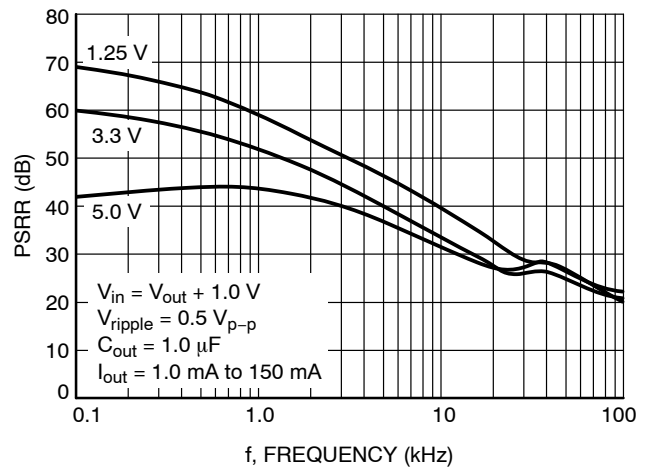

Figure 29. Power Supply Ripple Rejection vs. Frequency

NCP600

TYPICAL CHARACTERISTICS

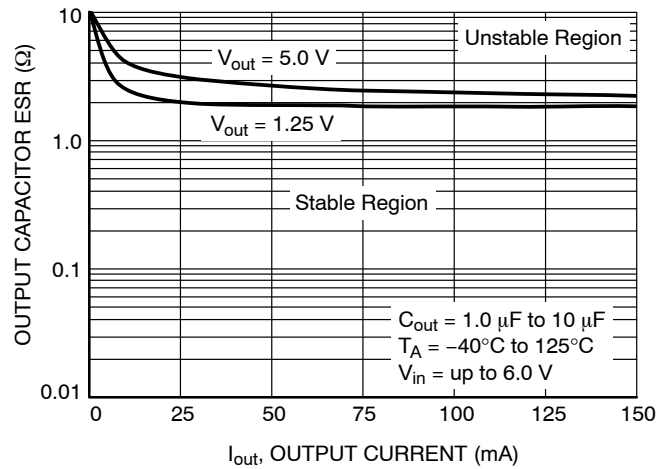

Figure 30. Output Stability with Output Capacitor ESR over Output Current

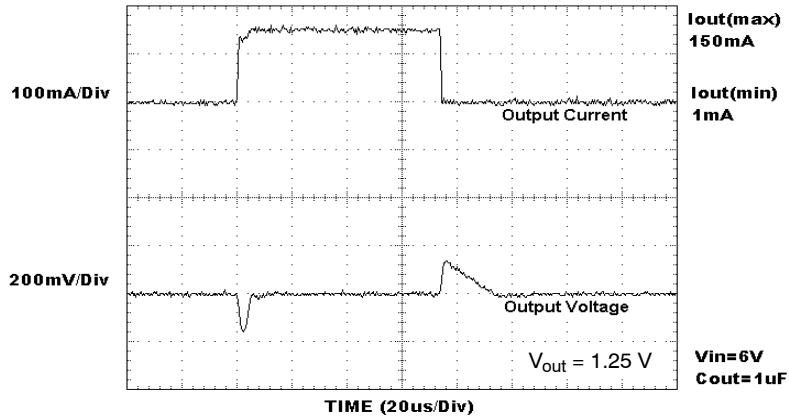

Figure 31. Load Transient Response ($1.0\ \mu\text{F}$)

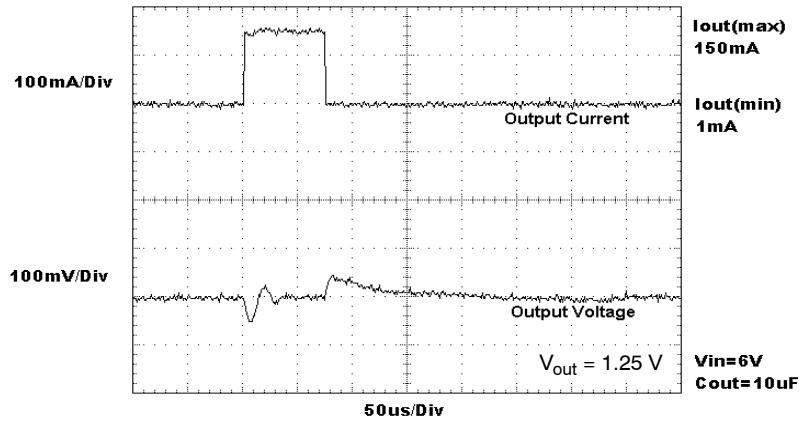

Figure 32. Load Transient Response ($10\ \mu\text{F}$)

NCP600

DEFINITIONS

Load Regulation

The change in output voltage for a change in output load current at a constant temperature.

Dropout Voltage

The input/output differential at which the regulator output no longer maintains regulation against further reductions in input voltage. Measured when the output drops 2% below its nominal. The junction temperature, load current, and minimum input supply requirements affect the dropout level.

Output Noise Voltage

This is the integrated value of the output noise over a specified frequency range. Input voltage and output load current are kept constant during the measurement. Results are expressed in μV_{rms} or $\text{nV}/\sqrt{\text{Hz}}$.

Disable and Ground Current

Ground Current (I_{GND}) is the current that flows through the ground pin when the regulator operates with a load on its output. This consists of internal IC operation, bias, etc. It is actually the difference between the input current (measured through the LDO input pin) and the output load current. If the regulator has an input pin that reduces its internal bias and shuts off the output (enable/disable function), this term is called the disable current (I_{DIS}).

Line Regulation

The change in output voltage for a change in input voltage. The measurement is made under conditions of low dissipation or by using pulse techniques such that the average junction temperature is not significantly affected.

Line Transient Response

Typical output voltage overshoot and undershoot response when the input voltage is excited with a given slope.

Load Transient Response

Typical output voltage overshoot and undershoot response when the output current is excited with a given slope between no-load and full-load conditions.

Thermal Protection

Internal thermal shutdown circuitry is provided to protect the integrated circuit in the event that the maximum junction temperature is exceeded. When activated at typically 175°C, the regulator turns off. This feature is provided to prevent failures from accidental overheating.

Maximum Package Power Dissipation

The power dissipation level at which the junction temperature reaches its maximum operating value.

APPLICATIONS INFORMATION

The NCP600 series regulator is self-protected with internal thermal shutdown and internal current limit. Typical application circuits are shown in Figures 4 and 5.

Input Decoupling (C_{in})

A ceramic or tantalum 1.0 μF capacitor is recommended and should be connected close to the NCP600 package. Higher capacitance and lower ESR will improve the overall line transient response.

Output Decoupling (C_{out})

The NCP600 is a stable component and does not require a minimum Equivalent Series Resistance (ESR) for the output capacitor. The minimum output decoupling value is 1.0 μF and can be augmented to fulfill stringent load transient requirements. The regulator works with ceramic chip capacitors as well as tantalum devices. Larger values improve noise rejection and load regulation transient response. Figure 30 shows the stability region for a range of operating conditions and ESR values.

No-Load Regulation Considerations

The NCP600 adjustable regulator will operate properly under conditions where the only load current is through the resistor divider that sets the output voltage. However, in the case where the NCP600 is configured to provide a 1.250 V

output, there is no resistor divider. If the part is enabled under no-load conditions, leakage current through the pass transistor at junction temperatures above 85°C can approach several microamps, especially as junction temperature approaches 150°C. If this leakage current is not directed into a load, the output voltage will rise up to a level approximately 20 mV above nominal.

The NCP600 contains an overshoot clamp circuit to improve transient response during a load current step release. When output voltage exceeds the nominal by approximately 20 mV, this circuit becomes active and clamps the output from further voltage increase. Tying the ENABLE pin to V_{in} will ensure that the part is active whenever the supply voltage is present, thus guaranteeing that the clamp circuit is active whenever leakage current is present.

When the NCP600 adjustable regulator is disabled, the overshoot clamp circuit becomes inactive and the pass transistor leakage will charge any capacitance on V_{out} . If no load is present, the output can charge up to within a few millivolts of V_{in} . In most applications, the load will present some impedance to V_{out} such that the output voltage will be inherently clamped at a safe level. A minimum load of 10 μA is recommended.

NCP600

Noise Decoupling

The NCP600 is a low noise regulator and needs no external noise reduction capacitor. Unlike other low noise regulators which require an external capacitor and have slow startup times, the NCP600 operates without a noise reduction capacitor, has a typical 15 μ s start up delay and achieves a 50 μ V_{rms} overall noise level between 10 Hz and 100 kHz.

Enable Operation

The enable pin will turn the regulator on or off. The threshold limits are covered in the electrical characteristics table in this data sheet. The turn-on/turn-off transient voltage being supplied to the enable pin should exceed a slew rate of 10 mV/ μ s to ensure correct operation. If the enable function is not to be used then the pin should be connected to V_{in}.

Output Voltage Adjust

The output voltage can be adjusted from 1 times (Figure 4) to 4 times (Figure 5) the typical 1.250 V regulation voltage via the use of resistors between the output and the ADJ input. The output voltage and resistors are chosen using Equation 1 and Equation 2.

$$V_{out} = 1.250 \left(1 + \frac{R_1}{R_2} \right) + (I_{ADJ} \times R_1) \quad (\text{eq. 1})$$

$$R_2 \cong \frac{R_1}{\frac{V_{out}}{1.25} - 1} \quad (\text{eq. 2})$$

Input bias current I_{ADJ} is typically less than 150 nA. Choose R2 arbitrarily to minimize errors due to the bias current and to minimize noise contribution to the output voltage. Use Equation 2 to find the required value for R1.

Thermal

As power in the NCP600 increases, it might become necessary to provide some thermal relief. The maximum power dissipation supported by the device is dependent upon board design and layout. Mounting pad configuration on the PCB, the board material, and the ambient temperature affect the rate of junction temperature rise for the part. When the NCP600 has good thermal conductivity through the PCB, the junction temperature will be relatively low with high power applications. The maximum dissipation the NCP600 can handle is given by:

$$P_{D(MAX)} = \frac{T_{J(MAX)} - T_A}{R_{\theta JA}} \quad (\text{eq. 3})$$

Since T_J is not recommended to exceed 125°C (T_{J(MAX)}), then the NCP600 in a DFN6 package can dissipate up to 870 mW when the ambient temperature (T_A) is 25°C, and PCB area is 640 mm² and larger, see Figure 33.

The power dissipated by the NCP600 can be calculated from the following equations:

$$P_D \approx V_{in}(I_{GND} @ I_{out}) + I_{out}(V_{in} - V_{out}) \quad (\text{eq. 4})$$

or

$$V_{in(MAX)} \approx \frac{P_{D(MAX)} + (V_{out} \times I_{out})}{I_{out} + I_{GND}} \quad (\text{eq. 5})$$

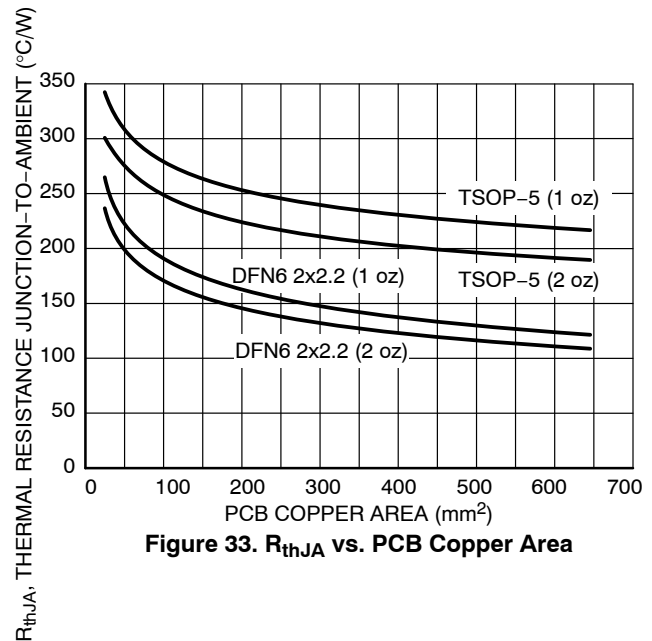

Figure 33. R_{thJA} vs. PCB Copper Area

Hints

V_{in} and GND printed circuit board traces should be as wide as possible. When the impedance of these traces is high, there is a chance to pick up noise or cause the regulator to malfunction. Place external components, especially the output capacitor, as close as possible to the NCP600, and make traces as short as possible.

NCP600

DEVICE ORDERING INFORMATION

| Device | Marking Code | Version | Package | Shipping* |
|----------------|--------------|---------|---------------------|--------------------|
| NCP600SNADJT1G | LIO | ADJ | TSOP-5 (Pb-Free) | 3000 / Tape & Reel |
| NCP600SN130T1G | LJZ | 1.3 V | | |
| NCP600SN150T1G | LID | 1.5 V | | |
| NCP600SN180T1G | LIE | 1.8 V | | |
| NCP600SN250T1G | ACM | 2.5 V | | |
| NCP600SN280T1G | LIH | 2.8 V | | |
| NCP600SN300T1G | LIJ | 3.0 V | | |
| NCP600SN330T1G | LIK | 3.3 V | | |
| NCP600SN350T1G | LJR | 3.5 V | | |
| NCP600SN500T1G | LIN | 5.0 V | | |
| NCP600MN130R2G | L2 | 1.3 V | DFN6 (Pb-Free) | 3000 / Tape & Reel |

*For additional information on our Pb-Free strategy and soldering details, please download the ON Semiconductor Soldering and Mounting Techniques Reference Manual, SOLDERRM/D.

NCP600

PACKAGE DIMENSIONS

TSOP-5 CASE 483-02 ISSUE H

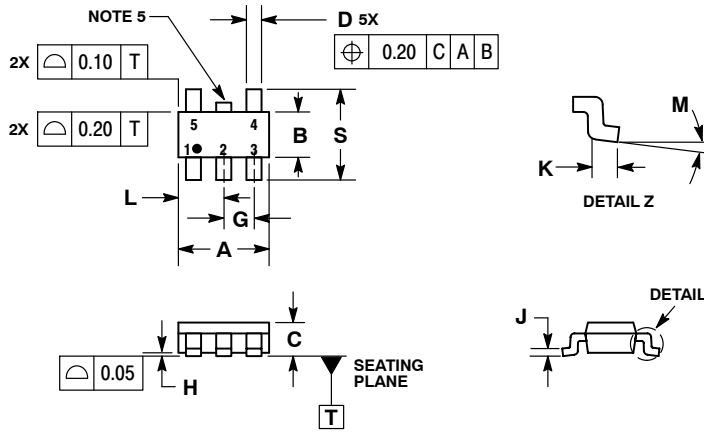

NOTES:

1. DIMENSIONING AND TOLERANCING PER ASME Y14.5M, 1994.
2. CONTROLLING DIMENSION: MILLIMETERS.
3. MAXIMUM LEAD THICKNESS INCLUDES LEAD FINISH THICKNESS. MINIMUM LEAD THICKNESS IS THE MINIMUM THICKNESS OF BASE MATERIAL.
4. DIMENSIONS A AND B DO NOT INCLUDE MOLD FLASH, PROTRUSIONS, OR GATE BURRS.
5. OPTIONAL CONSTRUCTION: AN ADDITIONAL TRIMMED LEAD IS ALLOWED IN THIS LOCATION. TRIMMED LEAD NOT TO EXTEND MORE THAN 0.2 FROM BODY.

| DIM | MILLIMETERS | |
|-----|-------------|------|
| | MIN | MAX |
| A | 3.00 | BSC |
| B | 1.50 | BSC |
| C | 0.90 | 1.10 |
| D | 0.25 | 0.50 |
| G | 0.95 | BSC |
| H | 0.01 | 0.10 |
| J | 0.10 | 0.26 |
| K | 0.20 | 0.60 |
| L | 1.25 | 1.55 |
| M | 0° | 10° |
| S | 2.50 | 3.00 |

SOLDERING FOOTPRINT*

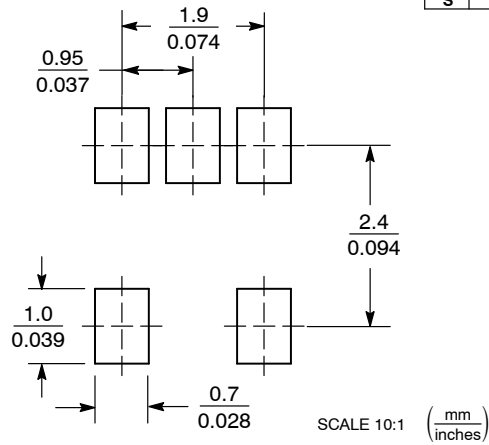

*For additional information on our Pb-Free strategy and soldering details, please download the ON Semiconductor Soldering and Mounting Techniques Reference Manual, SOLDERRM/D.

NCP600

PACKAGE DIMENSIONS

6 PIN DFN, 2x2.2, 0.65P CASE 506BA ISSUE A

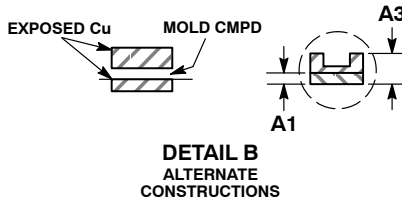
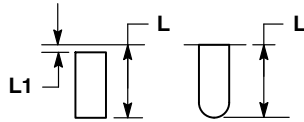
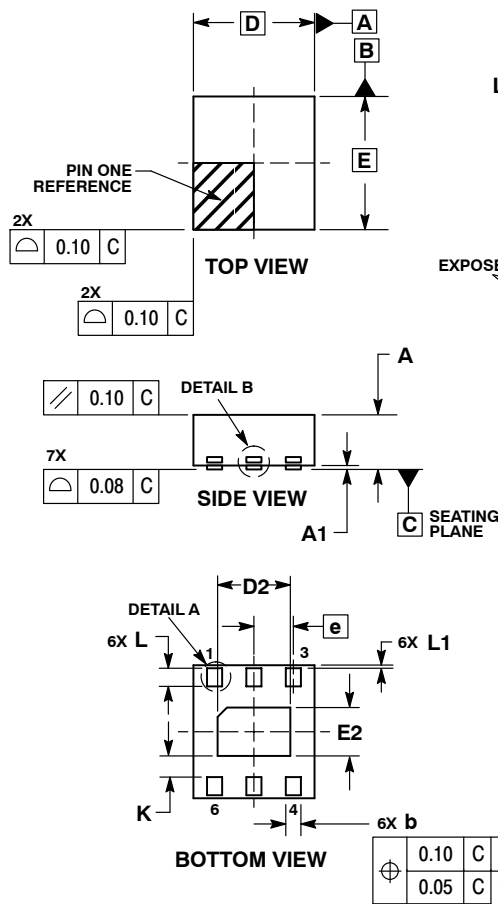

- NOTES:
1. DIMENSIONING AND TOLERANCING PER ASME Y14.5M, 1994.
 2. CONTROLLING DIMENSION: MILLIMETERS.
 3. DIMENSION b APPLIES TO PLATED TERMINAL AND IS MEASURED BETWEEN 0.15 AND 0.20 mm FROM TERMINAL.
 4. COPLANARITY APPLIES TO THE EXPOSED PAD AS WELL AS THE TERMINALS.

| MILLIMETERS | | |
|-------------|----------|------|
| DIM | MIN | MAX |
| A | 0.80 | 1.00 |
| A1 | 0.00 | 0.05 |
| b | 0.20 | 0.30 |
| D | 2.00 BSC | |
| D2 | 1.10 | 1.30 |
| E | 2.20 BSC | |
| E2 | 0.70 | 0.90 |
| e | 0.65 BSC | |
| K | 0.20 | --- |
| L | 0.25 | 0.35 |
| L1 | 0.00 | 0.10 |

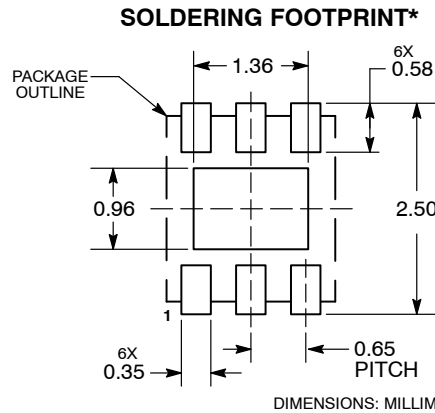

*For additional information on our Pb-Free strategy and soldering details, please download the ON Semiconductor Soldering and Mounting Techniques Reference Manual, SOLDERRM/D.

ON Semiconductor and are registered trademarks of Semiconductor Components Industries, LLC (SCILLC). SCILLC owns the rights to a number of patents, trademarks, copyrights, trade secrets, and other intellectual property. A listing of SCILLC's product/patent coverage may be accessed at www.onsemi.com/site/pdf/Patent-Marking.pdf. SCILLC reserves the right to make changes without further notice to any products herein. SCILLC makes no warranty, representation or guarantee regarding the suitability of its products for any particular purpose, nor does SCILLC assume any liability arising out of the application or use of any product or circuit, and specifically disclaims any and all liability, including without limitation special, consequential or incidental damages. "Typical" parameters which may be provided in SCILLC data sheets and/or specifications can and do vary in different applications and actual performance may vary over time. All operating parameters, including "Typicals" must be validated for each customer application by customer's technical experts. SCILLC does not convey any license under its patent rights nor the rights of others. SCILLC products are not designed, intended, or authorized for use as components in systems intended for surgical implant into the body, or other applications intended to support or sustain life, or for any other application in which the failure of the SCILLC product could create a situation where personal injury or death may occur. Should Buyer purchase or use SCILLC products for any such unintended or unauthorized application, Buyer shall indemnify and hold SCILLC and its officers, employees, subsidiaries, affiliates, and distributors harmless against all claims, costs, damages, and expenses, and reasonable attorney fees arising out of, directly or indirectly, any claim of personal injury or death associated with such unintended or unauthorized use, even if such claim alleges that SCILLC was negligent regarding the design or manufacture of the part. SCILLC is an Equal Opportunity/Affirmative Action Employer. This literature is subject to all applicable copyright laws and is not for resale in any manner.

PUBLICATION ORDERING INFORMATION

LITERATURE FULFILLMENT:

Literature Distribution Center for ON Semiconductor
P.O. Box 5163, Denver, Colorado 80217 USA
Phone: 303-675-2175 or 800-344-3860 Toll Free USA/Canada
Fax: 303-675-2176 or 800-344-3867 Toll Free USA/Canada
Email: orderlit@onsemi.com

N. American Technical Support: 800-282-9855 Toll Free
USA/Canada
Europe, Middle East and Africa Technical Support:
Phone: 421 33 790 2910
Japan Customer Focus Center
Phone: 81-3-5817-1050



ON Semiconductor Website: www.onsemi.com

Order Literature: <http://www.onsemi.com/orderlit>

For additional information, please contact your local Sales Representative

Looking for pricing, stock, or lifecycle information?

Click below to explore more details on WIN SOURCE:

-  [View NCP600SN130T1G on WIN SOURCE](#)
-  [ON Semiconductor Information](#)

Optimize Your Supply Chain with WIN SOURCE Solutions

-  Global Sourcing Solution
-  Obsolete Management
-  Cost Control Management
-  Shortage Management
-  Alternative Solution
-  Excess Inventory Management