



**THE DATASHEET OF
AP2139AK-1.5TRG1**



Description

The AP2138/2139 series are CMOS-based positive voltage regulator ICs. Each of these ICs consists of a voltage reference, an error amplifier, a resistor network for setting output voltage and a current limit circuit for current protection.

The difference between AP2138 and AP2139 is the AP2139 has an enable circuit with a quick discharge function.

These ICs feature high output voltage accuracy, extremely low quiescent current and low dropout voltage which make them ideal for use in various power sources for portable applications.

The AP2138/2139 series have 1.2V, 1.4V, 1.5V, 1.8V, 2.1V, 2.2V, 2.5V, 2.8V, 3.0V, 3.3V, 3.6V and 4.0V fixed output voltage versions.

The AP2138 series is available in SOT-23-3 and SOT-89 packages, AP2139 series is available in SOT-23-5 package.

Features

- Ultra-Low Quiescent Current: 1.0 μ A Typical
- Output Voltages: 1.2V, 1.4V, 1.5V, 1.8V, 2.1V, 2.2V, 2.5V, 2.8V, 3.0V, 3.3V, 3.6V and 4.0V
- High Output Voltage Accuracy: $\pm 2\%$
- Output Current: 250mA
- Low Dropout Voltage:
 - 25mV Typical at $I_{OUT} = 10\text{mA}$ and $V_{OUT} = 3\text{V}$
 - 200mV Typical at $I_{OUT} = 100\text{mA}$ and $V_{OUT} = 3\text{V}$
- Line Regulation: 6mV Typical
- Load Regulation: 25mV Typical
- Low Output Voltage Temperature Coefficient: $\pm 100\text{ppm}/^\circ\text{C}$
- Low Standby Current: 0.1 μ A Typical (AP2139)
- Active Quick Output Discharge (AP2139)
- Logic-Controlled Enable (AP2139)
- **Totally Lead-Free & Fully RoHS Compliant (Notes 1 & 2)**
- **Halogen and Antimony Free. "Green" Device (Note 3)**

Applications

- Battery Powered Equipment
- Reference Voltage Sources
- Cameras, Video Cameras
- Portable AV Systems
- Mobile Phones
- Communication Tools
- Portable Games

- Notes:
1. No purposely added lead. Fully EU Directive 2002/95/EC (RoHS), 2011/65/EU (RoHS 2) & 2015/863/EU (RoHS 3) compliant.
 2. See <https://www.diodes.com/quality/lead-free/> for more information about Diodes Incorporated's definitions of Halogen- and Antimony-free, "Green" and Lead-free.
 3. Halogen- and Antimony-free "Green" products are defined as those which contain <900ppm bromine, <900ppm chlorine (<1500ppm total Br + Cl) and <1000ppm antimony compounds.

Pin Assignments

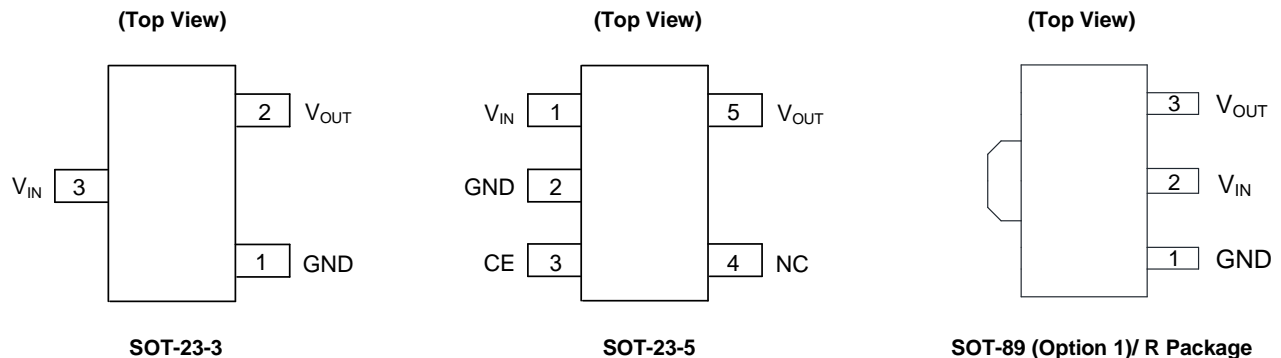

Pin Assignments (continued)

(Top View)

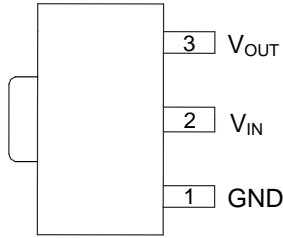

SOT-89 (Option 2) R Package

(Top View)

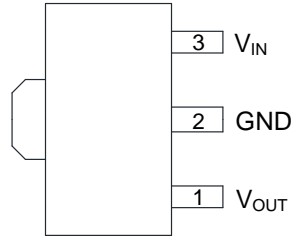

SOT-89 (Option 1) RA Package

(Top View)

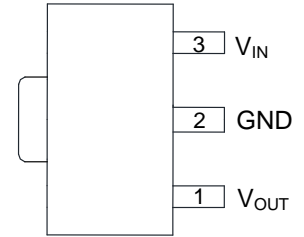

SOT-89 (Option 2) RA Package

Typical Applications Circuit (Note 4)

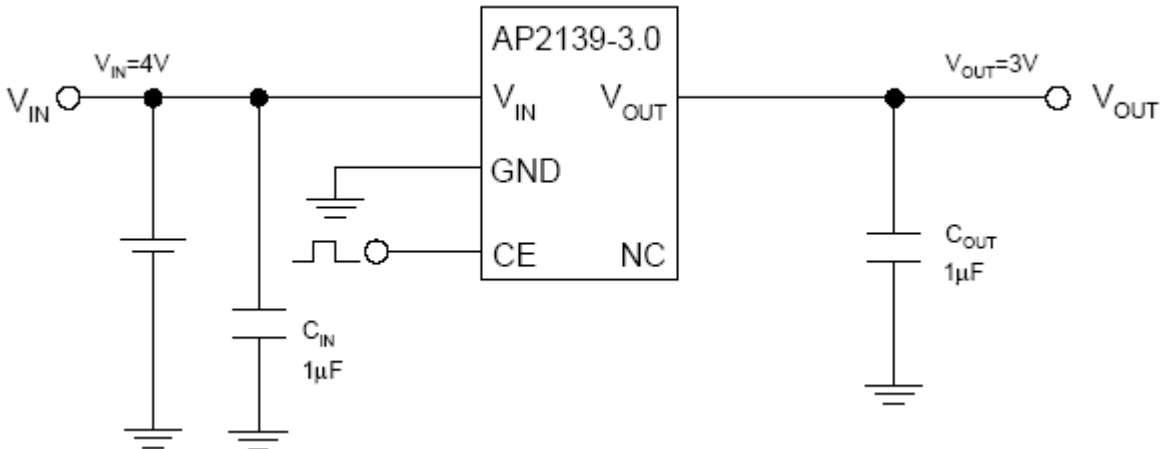
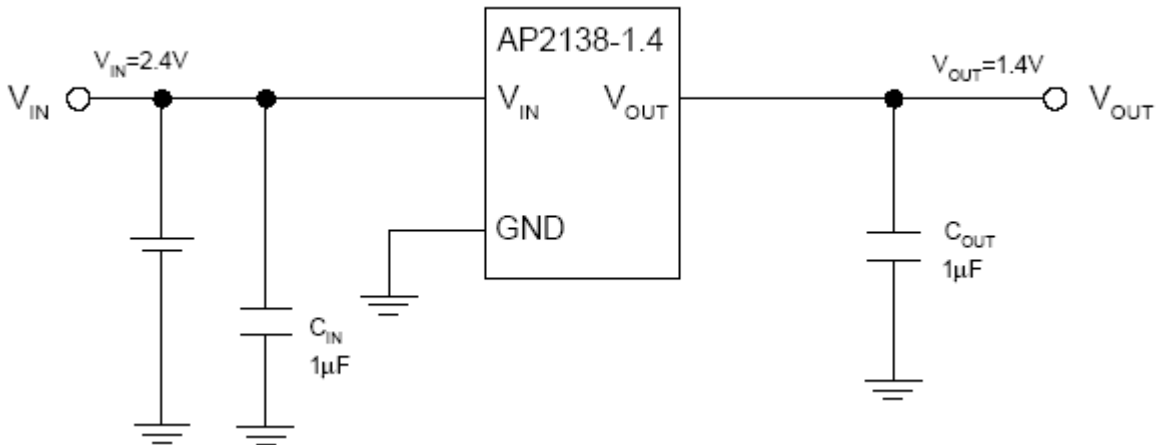

Note 4: Filter capacitors are required at the AP2138/2139's input and output. 1µF capacitor is required at the input. The minimum output capacitance required for stability should be more than 1µF with ESR from 0.01Ω to 100Ω. Ceramic capacitors are recommended.

Pin Description

Pin Number				Pin Name	Function
SOT-23-3	SOT-89 (R)	SOT-89 (RA)	SOT-23-5		
1	1	2	2	GND	Ground
2	3	1	5	V _{OUT}	Regulated output voltage
3	2	3	1	V _{IN}	Input voltage
—	—	—	3	CE	Active high enable input. Logic high=enable, logic low=shutdown
—	—	—	4	NC	No connection

Functional Block Diagram



A(B)[C]
A: SOT-23-3
B: SOT-89 (R)
C: SOT-89 (RA)

AP2138



AP2139

Absolute Maximum Ratings (Note 5)

Symbol	Parameter	Rating		Unit
V _{IN}	Input Voltage	6.6		V
V _{CE}	Enable Input Voltage (AP2139)	-0.3 to V _{IN} +0.3		V
T _{LEAD}	Lead Temperature	+260		°C
T _J	Junction Temperature	+150		°C
T _{STG}	Storage Temperature Range	-65 to +150		°C
ESD	ESD (Machine Model)	350		V
ESD	ESD (Human Body Model)	2000		V
θ _{JA}	Thermal Resistance (Note 6)	SOT-23-3	250	°C/W
		SOT-23-5	250	
		SOT-89	165	

- Notes:
- Stresses greater than those listed under “*Absolute Maximum Ratings*” can cause permanent damage to the device. These are stress ratings only, and functional operation of the device at these or any other conditions beyond those indicated under “*Recommended Operating Conditions*” is not implied. Exposure to “*Absolute Maximum Ratings*” for extended periods can affect device reliability.
 - Absolute maximum ratings indicate limits beyond which damage to the component can occur. Electrical specifications do not apply when operating the device outside of its operating ratings. The maximum allowable power dissipation is a function of the maximum junction temperature, T_{J(max)}, the junction-to-ambient thermal resistance, θ_{JA}, and the ambient temperature, T_A. The maximum allowable power dissipation at any ambient temperature is calculated using: P_{D(max)}=(T_{J(max)} - T_A)/θ_{JA}. Exceeding the maximum allowable power dissipation will result in excessive die temperature.

Recommended Operating Conditions

Symbol	Parameter	Min	Max	Unit
V _{IN}	Input Voltage	2.5	6.0	V
T _A	Operating Ambient Temperature Range	-40	+85	°C

Electrical Characteristics

AP2138/2139-1.2 (@ $V_{IN} = 2.5V$, $V_{CE} = 2.5V$ (AP2139), $T_J = +25^\circ C$, $I_{OUT} = 40mA$, $C_{IN} = C_{OUT} = 1\mu F$, **Bold** typeface applies $-40^\circ C \leq T_J \leq +85^\circ C$, unless otherwise specified.)

Symbol	Parameter	Conditions	Min	Typ	Max	Unit
V_{IN}	Input Voltage	—	—	—	6.0	V
V_{OUT}	Output Voltage	—	1.176	1.200	1.224	V
I_Q	Quiescent Current	$I_{OUT} = 0$	—	1.0	1.5	μA
I_{STD}	Standby Current (AP2139)	$V_{CE} = 0$	—	0.1	1	μA
I_{OUT}	Output Current	—	250	—	—	mA
V_{RLOAD}	Load Regulation	$1mA \leq I_{OUT} \leq 100mA$	—	25	40	mV
V_{RLINE}	Line Regulation	$2.2V \leq V_{IN} \leq 6V$	—	6	18	mV
V_{DROP}	Dropout Voltage	$I_{OUT} = 10mA$	—	100	300	mV
		$I_{OUT} = 30mA$	—	400	700	
		$I_{OUT} = 100mA$	—	700	1000	
		$I_{OUT} = 250mA$	—	1000	1300	
$\Delta V_{OUT}/\Delta T$	Output Voltage Temperature Coefficient	—	—	± 140	—	$\mu V/^\circ C$
$(\Delta V_{OUT}/V_{OUT})/\Delta T$		—	—	± 100	—	ppm/ $^\circ C$
I_{SHORT}	Short Circuit Current	$V_{OUT} = 0$	—	50	—	mA
I_{PD}	CE Pull-Down Constant Current (AP2139)	—	—	0.2	—	μA
V_{IH}	CE Input Logic-High Voltage (AP2139)	—	1.2	—	—	V
V_{IL}	CE Input Logic-Low Voltage (AP2139)	—	—	—	0.3	V
θ_{JC}	Thermal Resistance	SOT-23-3	—	81.9	—	$^\circ C/W$
		SOT-23-5	—	81.9	—	
		SOT-89	—	51.1	—	

Electrical Characteristics (continued)

AP2138/2139-1.4 (@ $V_{IN} = 2.5V$, $V_{CE} = 2.5V$ (AP2139), $T_J = +25^{\circ}C$, $I_{OUT} = 40mA$, $C_{IN} = C_{OUT} = 1\mu F$, **Bold** typeface applies $-40^{\circ}C \leq T_J \leq +85^{\circ}C$, unless otherwise specified.)

Symbol	Parameter	Conditions	Min	Typ	Max	Unit
V_{IN}	Input Voltage	—	—	—	6.0	V
V_{OUT}	Output Voltage	—	1.372	1.400	1.428	V
I_Q	Quiescent Current	$I_{OUT} = 0$	—	1.0	1.5	μA
I_{STD}	Standby Current (AP2139)	$V_{CE} = 0$	—	0.1	1	μA
I_{OUT}	Output Current	—	250	—	—	mA
V_{RLOAD}	Load Regulation	$1mA \leq I_{OUT} \leq 100mA$	—	25	40	mV
V_{RLINE}	Line Regulation	$2.4V \leq V_{IN} \leq 6V$	—	6	18	mV
V_{DROP}	Dropout Voltage	$I_{OUT} = 10mA$	—	100	300	mV
		$I_{OUT} = 30mA$	—	400	700	
		$I_{OUT} = 100mA$	—	600	900	
		$I_{OUT} = 250mA$	—	1000	1300	
$\Delta V_{OUT}/\Delta T$	Output Voltage Temperature Coefficient	—	—	± 140	—	$\mu V/^{\circ}C$
$(\Delta V_{OUT}/V_{OUT})/\Delta T$		—	—	± 100	—	ppm/ $^{\circ}C$
I_{SHORT}	Short Circuit Current	$V_{OUT} = 0$	—	50	—	mA
I_{PD}	CE Pull-Down Constant Current (AP2139)	—	—	0.2	—	μA
V_{IH}	CE Input Logic-High Voltage (AP2139)	—	1.2	—	—	V
V_{IL}	CE Input Logic-Low Voltage (AP2139)	—	—	—	0.3	V
θ_{JC}	Thermal Resistance	SOT-23-3	—	81.9	—	$^{\circ}C/W$
		SOT-23-5	—	81.9	—	
		SOT-89	—	51.1	—	

Electrical Characteristics (continued)

AP2138/2139-1.5 (@ $V_{IN} = 2.5V$, $V_{CE} = 2.5V$ (AP2139), $T_J = +25^\circ C$, $I_{OUT} = 40mA$, $C_{IN} = C_{OUT} = 1\mu F$, **Bold** typeface applies $-40^\circ C \leq T_J \leq +85^\circ C$, unless otherwise specified.)

Symbol	Parameter	Conditions	Min	Typ	Max	Unit
V_{IN}	Input Voltage	—	—	—	6.0	V
V_{OUT}	Output Voltage	—	1.470	1.500	1.530	V
I_Q	Quiescent Current	$I_{OUT} = 0$	—	1.0	1.5	μA
I_{STD}	Standby Current (AP2139)	$V_{CE} = 0$	—	0.1	1	μA
I_{OUT}	Output Current	—	250	—	—	mA
V_{RLOAD}	Load Regulation	$1mA \leq I_{OUT} \leq 100mA$	—	25	40	mV
V_{RLINE}	Line Regulation	$2.5V \leq V_{IN} \leq 6V$	—	6	18	mV
V_{DROP}	Dropout Voltage	$I_{OUT} = 10mA$	—	100	300	mV
		$I_{OUT} = 30mA$	—	200	400	
		$I_{OUT} = 100mA$	—	600	900	
		$I_{OUT} = 250mA$	—	1000	1300	
$\Delta V_{OUT}/\Delta T$	Output Voltage Temperature Coefficient	—	—	± 150	—	$\mu V/^\circ C$
$(\Delta V_{OUT}/V_{OUT})/\Delta T$		—	—	± 100	—	ppm/ $^\circ C$
I_{SHORT}	Short Circuit Current	$V_{OUT} = 0$	—	50	—	mA
I_{PD}	CE Pull-Down Constant Current (AP2139)	—	—	0.2	—	μA
V_{IH}	CE Input Logic-High Voltage (AP2139)	—	1.2	—	—	V
V_{IL}	CE Input Logic-Low Voltage (AP2139)	—	—	—	0.3	V
θ_{JC}	Thermal Resistance	SOT-23-3	—	81.9	—	$^\circ C/W$
		SOT-23-5	—	81.9	—	
		SOT-89	—	51.1	—	

Electrical Characteristics (continued)

AP2138/2139-1.8 (@ $V_{IN} = 2.8V$, $V_{CE} = 2.8V$ (AP2139), $T_J = +25^{\circ}C$, $I_{OUT} = 40mA$, $C_{IN} = C_{OUT} = 1\mu F$, **Bold** typeface applies $-40^{\circ}C \leq T_J \leq +85^{\circ}C$, unless otherwise specified.)

Symbol	Parameter	Conditions	Min	Typ	Max	Unit
V_{IN}	Input Voltage	—	—	—	6.0	V
V_{OUT}	Output Voltage	—	1.764	1.800	1.836	V
I_Q	Quiescent Current	$I_{OUT} = 0$	—	1.0	1.5	μA
I_{STD}	Standby Current (AP2139)	$V_{CE} = 0$	—	0.1	1	μA
I_{OUT}	Output Current	—	250	—	—	mA
V_{RLOAD}	Load Regulation	$1mA \leq I_{OUT} \leq 100mA$	—	25	40	mV
V_{RLINE}	Line Regulation	$2.8V \leq V_{IN} \leq 6V$	—	6	18	mV
V_{DROP}	Dropout Voltage	$I_{OUT} = 10mA$	—	25	100	mV
		$I_{OUT} = 30mA$	—	120	250	
		$I_{OUT} = 100mA$	—	400	700	
		$I_{OUT} = 250mA$	—	850	1100	
$\Delta V_{OUT}/\Delta T$	Output Voltage Temperature Coefficient	—	—	± 180	—	$\mu V/^{\circ}C$
$(\Delta V_{OUT}/V_{OUT})/\Delta T$		—	—	± 100	—	ppm/ $^{\circ}C$
I_{SHORT}	Short Circuit Current	$V_{OUT} = 0$	—	50	—	mA
I_{PD}	CE Pull-Down Constant Current (AP2139)	—	—	0.2	—	μA
V_{IH}	CE Input Logic-High Voltage (AP2139)	—	1.2	—	—	V
V_{IL}	CE Input Logic-Low Voltage (AP2139)	—	—	—	0.3	V
θ_{JC}	Thermal Resistance	SOT-23-3	—	81.9	—	$^{\circ}C/W$
		SOT-23-5	—	81.9	—	
		SOT-89	—	51.1	—	

Electrical Characteristics (continued)

AP2138/2139-2.1 (@ $V_{IN} = 3.1V$, $V_{CE} = 3.1V$ (AP2139), $T_J = +25^{\circ}C$, $I_{OUT} = 40mA$, $C_{IN} = C_{OUT} = 1\mu F$, **Bold** typeface applies $-40^{\circ}C \leq T_J \leq +85^{\circ}C$, unless otherwise specified.)

Symbol	Parameter	Conditions	Min	Typ	Max	Unit
V_{IN}	Input Voltage	—	—	—	6.0	V
V_{OUT}	Output Voltage	—	2.058	2.100	2.142	V
I_Q	Quiescent Current	$I_{OUT} = 0$	—	1.0	1.5	μA
I_{STD}	Standby Current (AP2139)	$V_{CE} = 0$	—	0.1	1	μA
I_{OUT}	Output Current	—	250	—	—	mA
V_{RLOAD}	Load Regulation	$1mA \leq I_{OUT} \leq 100mA$	—	25	40	mV
V_{RLINE}	Line Regulation	$3.1V \leq V_{IN} \leq 6V$	—	6	18	mV
V_{DROP}	Dropout Voltage	$I_{OUT} = 10mA$	—	25	100	mV
		$I_{OUT} = 30mA$	—	120	250	
		$I_{OUT} = 100mA$	—	400	700	
		$I_{OUT} = 250mA$	—	750	1100	
$\Delta V_{OUT}/\Delta T$	Output Voltage Temperature Coefficient	—	—	± 180	—	$\mu V/^{\circ}C$
$(\Delta V_{OUT}/V_{OUT})/\Delta T$		—	—	± 100	—	ppm/ $^{\circ}C$
I_{SHORT}	Short Circuit Current	$V_{OUT} = 0$	—	50	—	mA
I_{PD}	CE Pull-Down Constant Current (AP2139)	—	—	0.2	—	μA
V_{IH}	CE Input Logic-High Voltage (AP2139)	—	1.2	—	—	V
V_{IL}	CE Input Logic-Low Voltage (AP2139)	—	—	—	0.3	V
θ_{JC}	Thermal Resistance	SOT-23-3	—	81.9	—	$^{\circ}C/W$

Electrical Characteristics (continued)

AP2138/2139-2.2 (@ $V_{IN} = 3.2V$, $V_{CE} = 3.2V$ (AP2139), $T_J = +25^\circ C$, $I_{OUT} = 40mA$, $C_{IN} = C_{OUT} = 1\mu F$, **Bold** typeface applies $-40^\circ C \leq T_J \leq +85^\circ C$, unless otherwise specified.)

Symbol	Parameter	Conditions	Min	Typ	Max	Unit
V_{IN}	Input Voltage	—	—	—	6.0	V
V_{OUT}	Output Voltage	—	2.156	2.2	2.244	V
I_Q	Quiescent Current	$I_{OUT} = 0$	—	1.0	1.5	μA
I_{STD}	Standby Current (AP2139)	$V_{CE} = 0$	—	0.1	1	μA
I_{OUT}	Output Current	—	250	—	—	mA
V_{RLOAD}	Load Regulation	$1mA \leq I_{OUT} \leq 100mA$	—	25	40	mV
V_{RLINE}	Line Regulation	$3.2V \leq V_{IN} \leq 6V$	—	6	18	mV
V_{DROP}	Dropout Voltage	$I_{OUT} = 10mA$	—	25	100	mV
		$I_{OUT} = 30mA$	—	120	250	
		$I_{OUT} = 100mA$	—	400	700	
		$I_{OUT} = 250mA$	—	700	1050	
$\Delta V_{OUT}/\Delta T$	Output Voltage Temperature Coefficient	—	—	± 180	—	$\mu V/^\circ C$
$(\Delta V_{OUT}/V_{OUT})/\Delta T$		—	—	± 100	—	ppm/ $^\circ C$
I_{SHORT}	Short Circuit Current	$V_{OUT} = 0$	—	50	—	mA
I_{PD}	CE Pull-Down Constant Current (AP2139)	—	—	0.2	—	μA
V_{IH}	CE Input Logic-High Voltage (AP2139)	—	1.2	—	—	V
V_{IL}	CE Input Logic-Low Voltage (AP2139)	—	—	—	0.3	V
θ_{JC}	Thermal Resistance	SOT-23-3	—	81.9	—	$^\circ C/W$

Electrical Characteristics (continued)

AP2138/2139-2.5 (@ $V_{IN} = 3.5V$, $V_{CE} = 3.5V$ (AP2139), $T_J = +25^\circ C$, $I_{OUT} = 40mA$, $C_{IN} = C_{OUT} = 1\mu F$, **Bold** typeface applies $-40^\circ C \leq T_J \leq +85^\circ C$, unless otherwise specified.)

Symbol	Parameter	Conditions	Min	Typ	Max	Unit
V_{IN}	Input Voltage	—	—	—	6.0	V
V_{OUT}	Output Voltage	—	2.450	2.500	2.550	V
I_Q	Quiescent Current	$I_{OUT} = 0$	—	1.0	1.5	μA
I_{STD}	Standby Current (AP2139)	$V_{CE} = 0$	—	0.1	1	μA
I_{OUT}	Output Current	—	250	—	—	mA
V_{RLOAD}	Load Regulation	$1mA \leq I_{OUT} \leq 100mA$	—	25	40	mV
V_{RLINE}	Line Regulation	$3.5V \leq V_{IN} \leq 6V$	—	6	18	mV
V_{DROP}	Dropout Voltage	$I_{OUT} = 10mA$	—	25	100	mV
		$I_{OUT} = 30mA$	—	100	250	
		$I_{OUT} = 100mA$	—	250	500	
		$I_{OUT} = 250mA$	—	650	1000	
$\Delta V_{OUT}/\Delta T$	Output Voltage Temperature Coefficient	—	—	± 250	—	$\mu V/^\circ C$
$(\Delta V_{OUT}/V_{OUT})/\Delta T$		—	—	± 100	—	ppm/ $^\circ C$
I_{SHORT}	Short Circuit Current	$V_{OUT} = 0$	—	50	—	mA
I_{PD}	CE Pull-Down Constant Current (AP2139)	—	—	0.2	—	μA
V_{IH}	CE Input Logic-High Voltage (AP2139)	—	1.2	—	—	V
V_{IL}	CE Input Logic-Low Voltage (AP2139)	—	—	—	0.3	V
θ_{JC}	Thermal Resistance	SOT-23-3	—	81.9	—	$^\circ C/W$
		SOT-23-5	—	81.9	—	
		SOT-89	—	51.1	—	

Electrical Characteristics (continued)

AP2138/2139-2.8 (@ $V_{IN} = 3.8V$, $V_{CE} = 3.8V$ (AP2139), $T_J = +25^{\circ}C$, $I_{OUT} = 40mA$, $C_{IN} = C_{OUT} = 1\mu F$, **Bold** typeface applies $-40^{\circ}C \leq T_J \leq +85^{\circ}C$, unless otherwise specified.)

Symbol	Parameter	Conditions	Min	Typ	Max	Unit
V_{IN}	Input Voltage	—	—	—	6.0	V
V_{OUT}	Output Voltage	—	2.744	2.800	2.856	V
I_Q	Quiescent Current	$I_{OUT} = 0$	—	1.0	1.5	μA
I_{STD}	Standby Current (AP2139)	$V_{CE} = 0$	—	0.1	1	μA
I_{OUT}	Output Current	—	250	—	—	mA
V_{RLOAD}	Load Regulation	$1mA \leq I_{OUT} \leq 100mA$	—	25	40	mV
V_{RLINE}	Line Regulation	$3.8V \leq V_{IN} \leq 6V$	—	6	18	mV
V_{DROP}	Dropout Voltage	$I_{OUT} = 10mA$	—	25	100	mV
		$I_{OUT} = 30mA$	—	70	200	
		$I_{OUT} = 100mA$	—	250	500	
		$I_{OUT} = 250mA$	—	500	800	
$\Delta V_{OUT}/\Delta T$	Output Voltage Temperature Coefficient	—	—	± 280	—	$\mu V/^{\circ}C$
$(\Delta V_{OUT}/V_{OUT})/\Delta T$		—	—	± 100	—	ppm/ $^{\circ}C$
I_{SHORT}	Short Circuit Current	$V_{OUT} = 0$	—	50	—	mA
I_{PD}	CE Pull-Down Constant Current (AP2139)	—	—	0.2	—	μA
V_{IH}	CE Input Logic-High Voltage (AP2139)	—	1.2	—	—	V
V_{IL}	CE Input Logic-Low Voltage (AP2139)	—	—	—	0.3	V
θ_{JC}	Thermal Resistance	SOT-23-3	—	81.9	—	$^{\circ}C/W$
		SOT-23-5	—	81.9	—	
		SOT-89	—	51.1	—	

Electrical Characteristics (continued)

AP2138/2139-3.0 (@ $V_{IN} = 4V$, $V_{CE} = 4V$ (AP2139), $T_J = +25^\circ C$, $I_{OUT} = 40mA$, $C_{IN} = C_{OUT} = 1\mu F$, **Bold** typeface applies $-40^\circ C \leq T_J \leq +85^\circ C$, unless otherwise specified.)

Symbol	Parameter	Conditions	Min	Typ	Max	Unit
V_{IN}	Input Voltage	—	—	—	6.0	V
V_{OUT}	Output Voltage	—	2.940	3.000	3.060	V
I_Q	Quiescent Current	$I_{OUT} = 0$	—	1.0	1.5	μA
I_{STD}	Standby Current (AP2139)	$V_{CE} = 0$	—	0.1	1	μA
I_{OUT}	Output Current	—	250	—	—	mA
V_{RLOAD}	Load Regulation	$1mA \leq I_{OUT} \leq 100mA$	—	25	40	mV
V_{RLINE}	Line Regulation	$4V \leq V_{IN} \leq 6V$	—	6	18	mV
V_{DROP}	Dropout Voltage	$I_{OUT} = 10mA$	—	25	100	mV
		$I_{OUT} = 30mA$	—	70	200	
		$I_{OUT} = 100mA$	—	200	400	
		$I_{OUT} = 250mA$	—	450	700	
$\Delta V_{OUT}/\Delta T$	Output Voltage Temperature Coefficient	—	—	± 300	—	$\mu V/^\circ C$
$(\Delta V_{OUT}/V_{OUT})/\Delta T$		—	—	± 100	—	ppm/ $^\circ C$
I_{SHORT}	Short Circuit Current	$V_{OUT} = 0$	—	50	—	mA
I_{PD}	CE Pull-Down Constant Current (AP2139)	—	—	0.2	—	μA
V_{IH}	CE Input Logic-High Voltage (AP2139)	—	1.2	—	—	V
V_{IL}	CE Input Logic-Low Voltage (AP2139)	—	—	—	0.3	V
θ_{JC}	Thermal Resistance	SOT-23-3	—	81.9	—	$^\circ C/W$
		SOT-23-5	—	81.9	—	
		SOT-89	—	51.1	—	

Electrical Characteristics (continued)

AP2138/2139-3.3 (@ $V_{IN} = 4.3V$, $V_{CE} = 4.3V$ (AP2139), $T_J = +25^\circ C$, $I_{OUT} = 40mA$, $C_{IN} = C_{OUT} = 1\mu F$, **Bold** typeface applies $-40^\circ C \leq T_J \leq +85^\circ C$, unless otherwise specified.)

Symbol	Parameter	Conditions	Min	Typ	Max	Unit
V_{IN}	Input Voltage	—	—	—	6.0	V
V_{OUT}	Output Voltage	—	3.234	3.300	3.366	V
I_Q	Quiescent Current	$I_{OUT} = 0$	—	1.0	1.5	μA
I_{STD}	Standby Current (AP2139)	$V_{CE} = 0$	—	0.1	1	μA
I_{OUT}	Output Current	—	250	—	—	mA
V_{RLOAD}	Load Regulation	$1mA \leq I_{OUT} \leq 100mA$	—	25	40	mV
V_{RLINE}	Line Regulation	$4.3V \leq V_{IN} \leq 6V$	—	6	18	mV
V_{DROP}	Dropout Voltage	$I_{OUT} = 10mA$	—	20	100	mV
		$I_{OUT} = 30mA$	—	50	200	
		$I_{OUT} = 100mA$	—	160	300	
		$I_{OUT} = 250mA$	—	400	600	
$\Delta V_{OUT}/\Delta T$	Output Voltage Temperature Coefficient	—	—	± 330	—	$\mu V/^\circ C$
$(\Delta V_{OUT}/V_{OUT})/\Delta T$		—	—	± 100	—	ppm/ $^\circ C$
I_{SHORT}	Short Circuit Current	$V_{OUT} = 0$	—	50	—	mA
I_{PD}	CE Pull-Down Constant Current (AP2139)	—	—	0.2	—	μA
V_{IH}	CE Input Logic-High Voltage (AP2139)	—	1.2	—	—	V
V_{IL}	CE Input Logic-Low Voltage (AP2139)	—	—	—	0.3	V
θ_{JC}	Thermal Resistance	SOT-23-3	—	81.9	—	$^\circ C/W$
		SOT-23-5	—	81.9	—	
		SOT-89	—	51.1	—	

Electrical Characteristics (continued)

AP2138/2139-3.6 (@ $V_{IN} = 4.6V$, $T_J = +25^\circ C$, $I_{OUT} = 40mA$, $C_{IN} = C_{OUT} = 1\mu F$, **Bold** typeface applies $-40^\circ C \leq T_J \leq +85^\circ C$, unless otherwise specified.)

Symbol	Parameter	Conditions	Min	Typ	Max	Unit
V_{IN}	Input Voltage	—	—	—	6.0	V
V_{OUT}	Output Voltage	—	3.528	3.600	3.672	V
I_Q	Quiescent Current	$I_{OUT} = 0$	—	1.0	1.5	μA
I_{OUT}	Output Current	—	250	—	—	mA
V_{RLOAD}	Load Regulation	$1mA \leq I_{OUT} \leq 100mA$	—	25	40	mV
V_{RLINE}	Line Regulation	$4.6V \leq V_{IN} \leq 6V$	—	6	18	mV
V_{DROP}	Dropout Voltage	$I_{OUT} = 10mA$	—	20	100	mV
		$I_{OUT} = 30mA$	—	50	200	
		$I_{OUT} = 100mA$	—	160	300	
		$I_{OUT} = 250mA$	—	400	600	
$\Delta V_{OUT}/\Delta T$	Output Voltage Temperature Coefficient	—	—	± 330	—	$\mu V/^\circ C$
$(\Delta V_{OUT}/V_{OUT})/\Delta T$		—	—	± 100	—	ppm/ $^\circ C$
I_{SHORT}	Short Circuit Current	$V_{OUT} = 0$	—	50	—	mA
θ_{JC}	Thermal Resistance	SOT-23-3	—	81.9	—	$^\circ C/W$
		SOT-89	—	51.1	—	

Electrical Characteristics (continued)

AP2138/2139-4.0 (@ $V_{IN} = 5.0V$, $T_J = +25^\circ C$, $I_{OUT} = 40mA$, $C_{IN} = C_{OUT} = 1\mu F$, **Bold** typeface applies $-40^\circ C \leq T_J \leq +85^\circ C$, unless otherwise specified.)

Symbol	Parameter	Conditions	Min	Typ	Max	Unit
V_{IN}	Input Voltage	—	—	—	6.0	V
V_{OUT}	Output Voltage	—	3.920	4.000	4.080	V
I_Q	Quiescent Current	$I_{OUT} = 0$	—	1.0	1.5	μA
I_{OUT}	Output Current	—	250	—	—	mA
V_{RLOAD}	Load Regulation	$1mA \leq I_{OUT} \leq 100mA$	—	25	40	mV
V_{RLINE}	Line Regulation	$5V \leq V_{IN} \leq 6V$	—	6	18	mV
V_{DROP}	Dropout Voltage	$I_{OUT} = 10mA$	—	20	100	mV
		$I_{OUT} = 30mA$	—	50	200	
		$I_{OUT} = 100mA$	—	160	300	
		$I_{OUT} = 250mA$	—	400	600	
$\Delta V_{OUT}/\Delta T$	Output Voltage Temperature Coefficient	—	—	± 330	—	$\mu V/^\circ C$
$(\Delta V_{OUT}/V_{OUT})/\Delta T$		—	—	± 100	—	ppm/ $^\circ C$
I_{SHORT}	Short Circuit Current	$V_{OUT} = 0$	—	50	—	mA
θ_{JC}	Thermal Resistance	SOT-23-3	—	81.9	—	$^\circ C/W$

Performance Characteristics

Output Voltage vs. Input Voltage

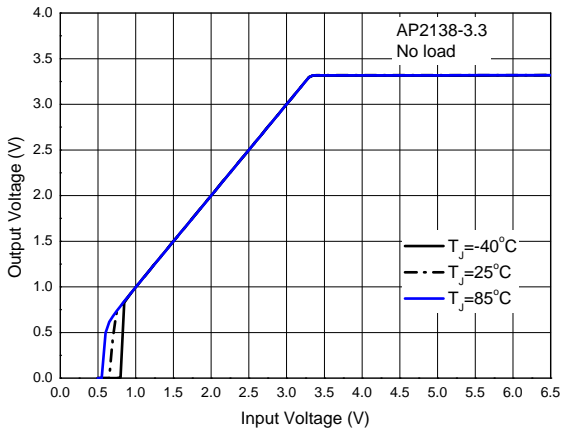

Output Voltage vs. Junction Temperature

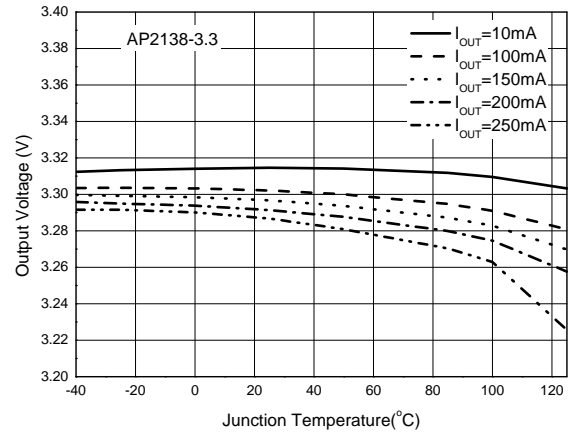

Output Voltage vs. Output Current

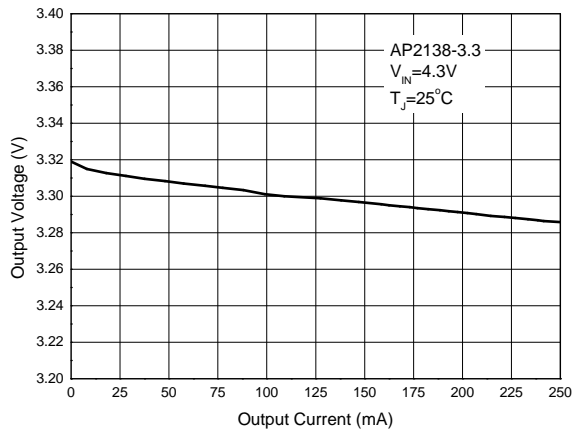

Quiescent Current vs. Input Voltage

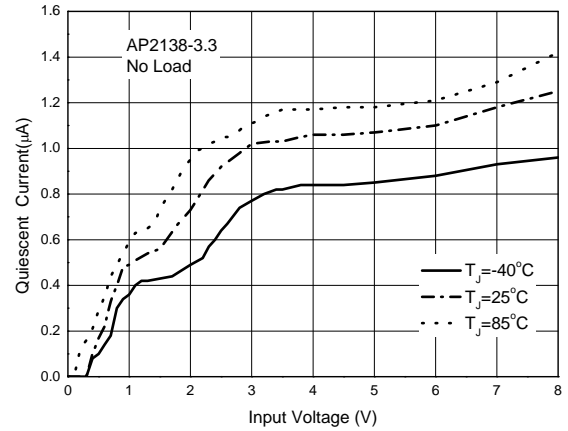

Quiescent Current vs. Junction Temperature

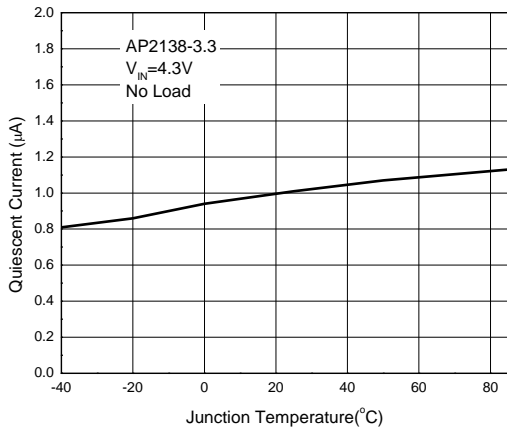

Quiescent Current vs. Output Current

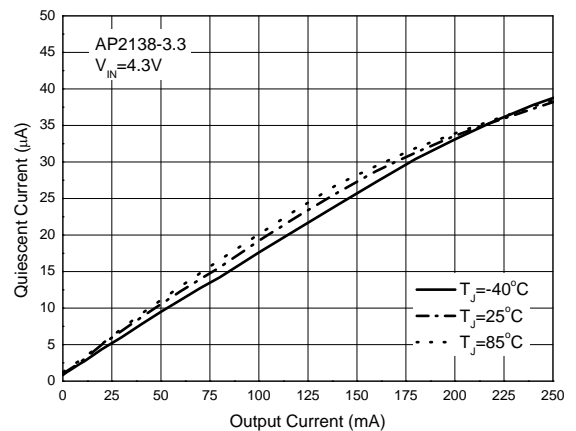

Performance Characteristics (continued)

Output Voltage vs. Output Current



Output Voltage vs. Output Current

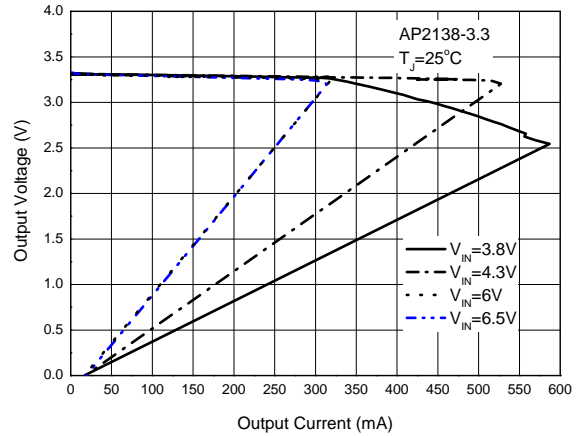

Dropout Voltage vs. Output Current

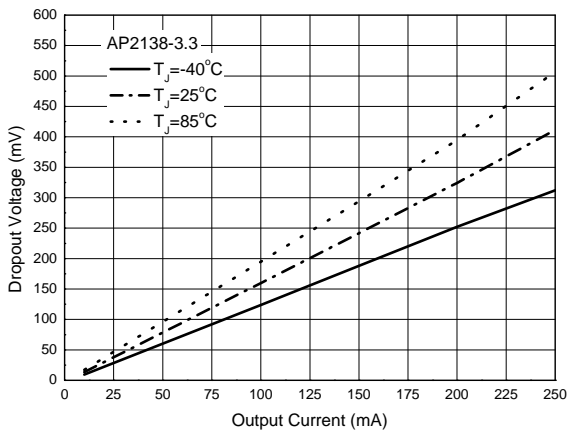

Dropout Voltage vs. Junction Temperature

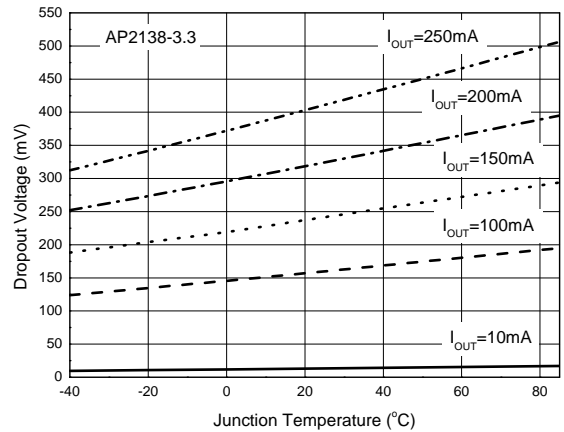

Line Transient (VIN=4.3V to 5.3V, IOUT=10mA)

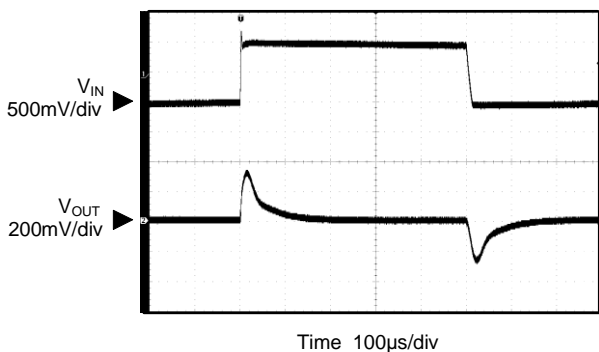

Load Transient (VIN=4.3V, IOUT=1mA to 150mA)

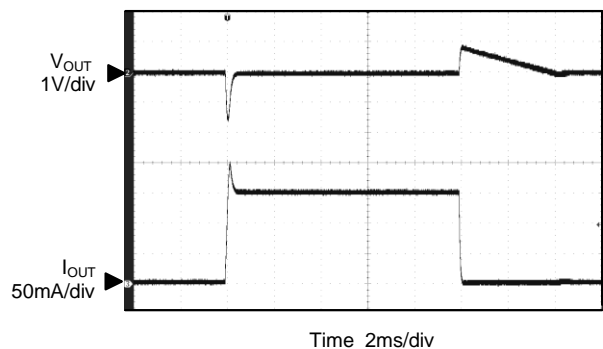

Performance Characteristics (continued)

Start-Up Response

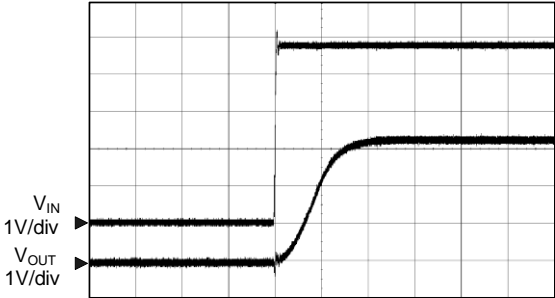

Time 200 μ s/div

Enable Input Response

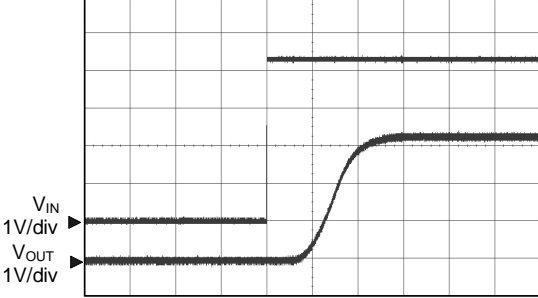

Time 200 μ s/div

Ordering Information



Package	Temperature Range	Condition	Part Number	Marking ID	Packing
SOT-23-3	-40 to +85°C	1.2V	AP2138N-1.2TRG1	JB	3000/Tape & Reel
		1.4V	AP2138N-1.4TRG1	JC	3000/Tape & Reel
		1.5V	AP2138N-1.5TRG1	JD	3000/Tape & Reel
		1.8V	AP2138N-1.8TRG1	JE	3000/Tape & Reel
		2.1V	AP2138N-2.1TRG1	JF	3000/Tape & Reel
		2.2V	AP2138N-2.2TRG1	PT	3000/Tape & Reel
		2.5V	AP2138N-2.5TRG1	PU	3000/Tape & Reel
		2.8V	AP2138N-2.8TRG1	PV	3000/Tape & Reel
		3.0V	AP2138N-3.0TRG1	PW	3000/Tape & Reel
		3.3V	AP2138N-3.3TRG1	PX	3000/Tape & Reel
		3.6V	AP2138N-3.6TRG1	PY	3000/Tape & Reel
				4.0V (NRND)(Note 7)	AP2138N-4.0TRG1
SOT-89	-40 to +85°C	1.2V (R) (NRND)(Note 7)	AP2138R-1.2TRG1	J2A	1000/Tape & Reel
		1.4V (R) (NRND)(Note 7)	AP2138R-1.4TRG1	J2B	1000/Tape & Reel
		1.5V (R) (NRND)(Note 7)	AP2138R-1.5TRG1	J2C	1000/Tape & Reel
		1.8V (R) (NRND)(Note 7)	AP2138R-1.8TRG1	J2D	1000/Tape & Reel
		2.5V (R) (NRND)(Note 7)	AP2138R-2.5TRG1	J2E	1000/Tape & Reel
		2.8V (R) (NRND)(Note 7)	AP2138R-2.8TRG1	J2F	1000/Tape & Reel
		3.0V (R) (NRND)(Note 7)	AP2138R-3.0TRG1	J2G	1000/Tape & Reel
		3.3V (R) (NRND)(Note 7)	AP2138R-3.3TRG1	J2H	1000/Tape & Reel
		3.6V (R) (NRND)(Note 7)	AP2138R-3.6TRG1	J2J	1000/Tape & Reel

Ordering Information (continued)

Package	Temperature Range	Condition	Part Number	Marking ID	Packing
SOT-89	-40 to +85°C	1.2V (RA) (NRND)(Note 7)	AP2138RA-1.2TRG1	J2K	1000/Tape & Reel
		1.4V (RA) (NRND)(Note 7)	AP2138RA-1.4TRG1	J2M	1000/Tape & Reel
		1.5V (RA) (NRND)(Note 7)	AP2138RA-1.5TRG1	J2N	1000/Tape & Reel
		1.8V (RA) (NRND)(Note 7)	AP2138RA-1.8TRG1	J2P	1000/Tape & Reel
		2.5V (RA) (NRND)(Note 7)	AP2138RA-2.5TRG1	J2R	1000/Tape & Reel
		2.8V (RA) (NRND)(Note 7)	AP2138RA-2.8TRG1	J2S	1000/Tape & Reel
		3.0V (RA) (NRND)(Note 7)	AP2138RA-3.0TRG1	J2T	1000/Tape & Reel
		3.3V (RA) (NRND)(Note 7)	AP2138RA-3.3TRG1	J2U	1000/Tape & Reel
SOT-23-5	-40 to +85°C	Active High with Built-in Resistor	AP2139AK-1.2TRG1	J2A	3000/Tape & Reel
		Active High with Built-in Resistor	AP2139AK-1.4TRG1	J2B	3000/Tape & Reel
		Active High with Built-in Resistor	AP2139AK-1.5TRG1	J2C	3000/Tape & Reel
		Active High with Built-in Resistor	AP2139AK-1.8TRG1	J2D	3000/Tape & Reel
		Active High with Built-in Resistor	AP2139AK-2.5TRG1	J2E	3000/Tape & Reel
		Active High with Built-in Resistor	AP2139AK-2.8TRG1	J2F	3000/Tape & Reel
		Active High with Built-in Resistor	AP2139AK-3.0TRG1	J2G	3000/Tape & Reel
		Active High with Built-in Resistor	AP2139AK-3.3TRG1	J2H	3000/Tape & Reel

Note 7: NRND: Not Recommended for New Design.

Marking Information

(1) SOT-23-3

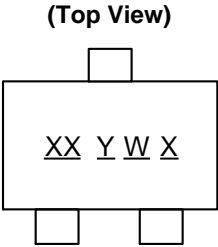

XX : Identification Code
Y : Year 0 to 9
W : Week : A to Z : 1 to 26 week;
a to z : 27 to 52 week; z represents 52 and 53 week
X : Internal Code

(2) SOT-89

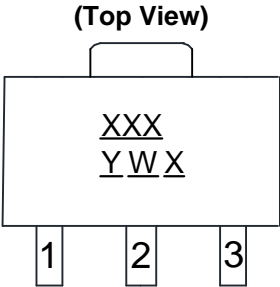

XXX : Identification Code
Y : Year : 0 to 9
W : Week : A to Z : 1 to 26 week;
a to z : 27 to 52 week;
z represents 52 and 53 week
X : Internal Code

(3) SOT-23-5

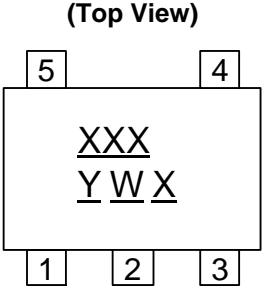

XXX : Identification Code
Y : Year 0 to 9
W : Week : A to Z : 1 to 26 week;
a to z : 27 to 52 week; z represents 52 and 53 week
X : Internal Code

Package Outline Dimensions (continued) (All dimensions in mm(inch).)

(2) Package Type: SOT-23-5

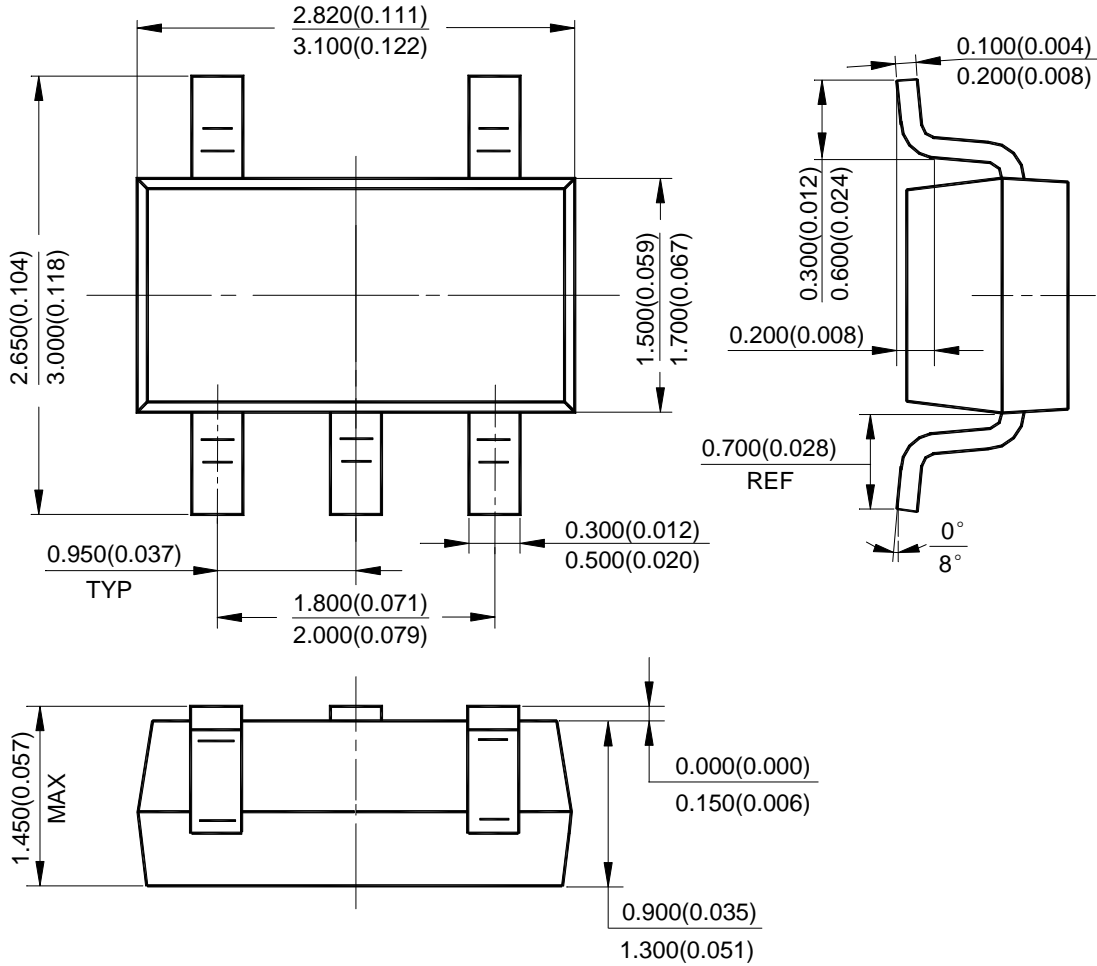

Package Outline Dimensions (continued) (All dimensions in mm(inch).)

(3) Package Type: SOT-89

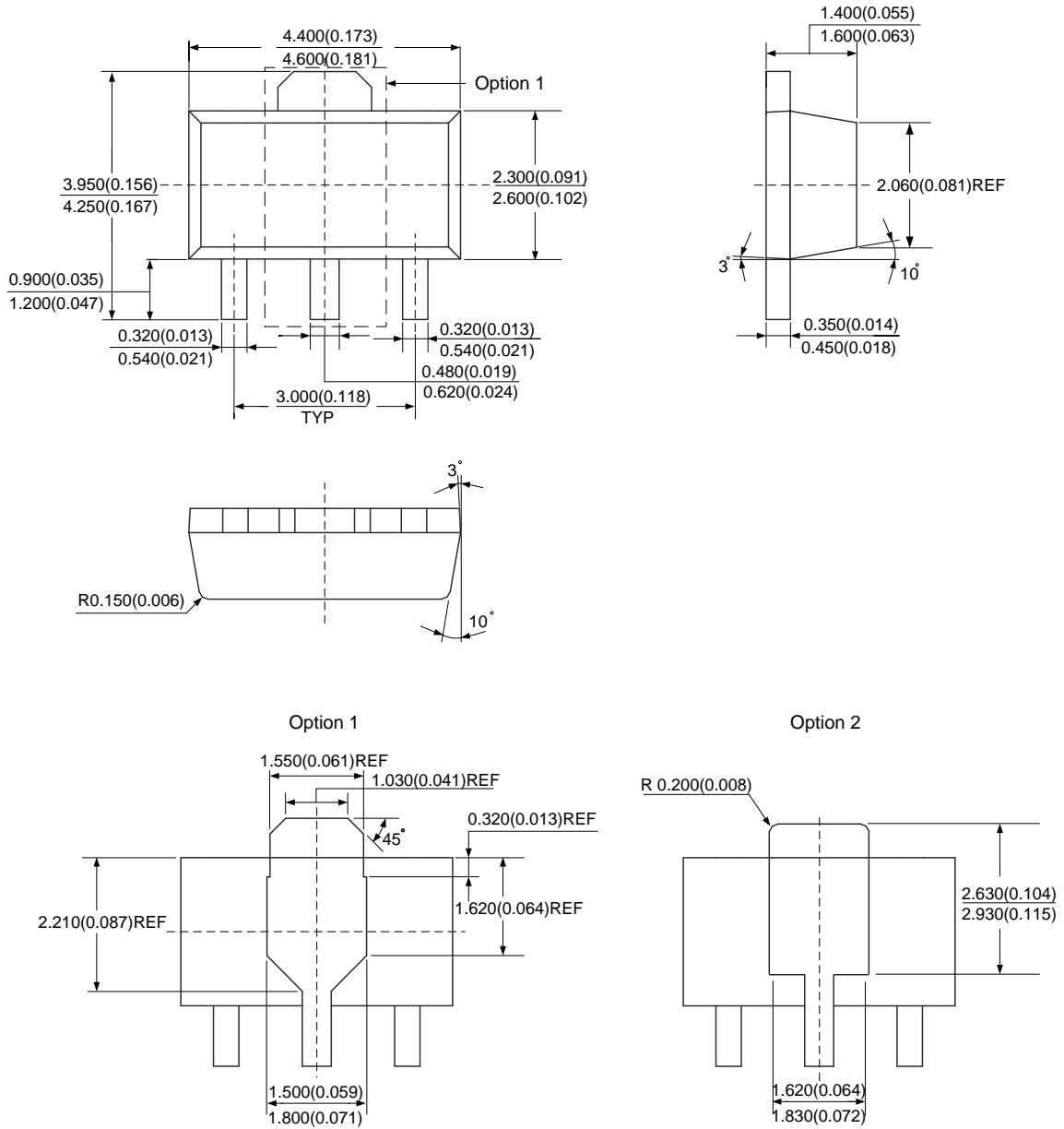

Suggested Pad Layout

(1) Package Type: SOT-23-3



Dimensions	Z (mm)/(inch)	G (mm)/(inch)	X (mm)/(inch)	Y (mm)/(inch)	E1 (mm)/(inch)	E2 (mm)/(inch)
Value	3.600/0.142	1.600/0.063	0.700/0.028	1.000/0.039	0.950/0.037	1.900/0.075

Suggested Pad Layout (continued)

(2) Package Type: SOT-23-5

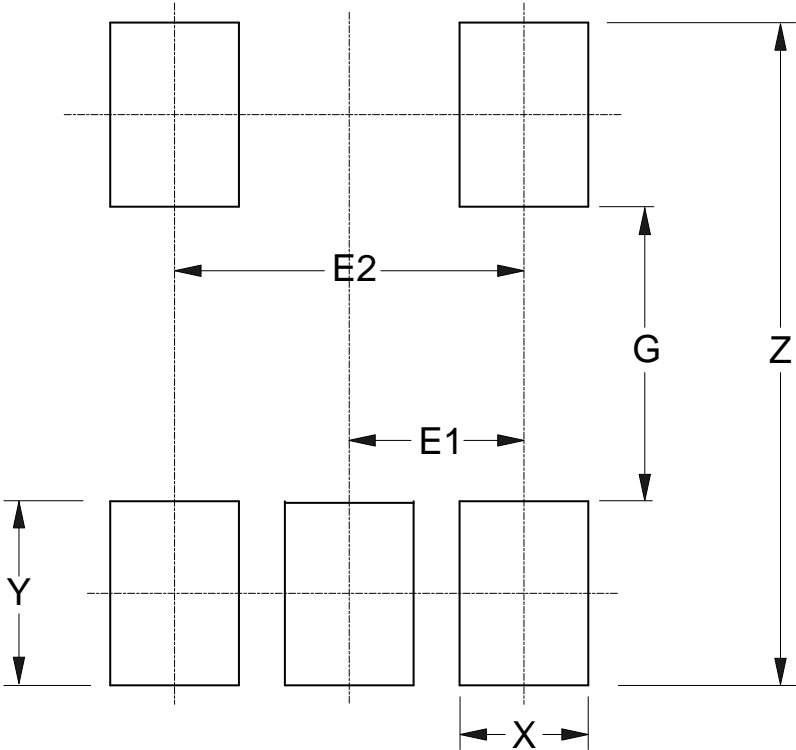

Dimensions	Z (mm)/(inch)	G (mm)/(inch)	X (mm)/(inch)	Y (mm)/(inch)	E1 (mm)/(inch)	E2 (mm)/(inch)
Value	3.600/0.142	1.600/0.063	0.700/0.028	1.000/0.039	0.950/0.037	1.900/0.075

Suggested Pad Layout (continued)

(3) Package Type: SOT-89

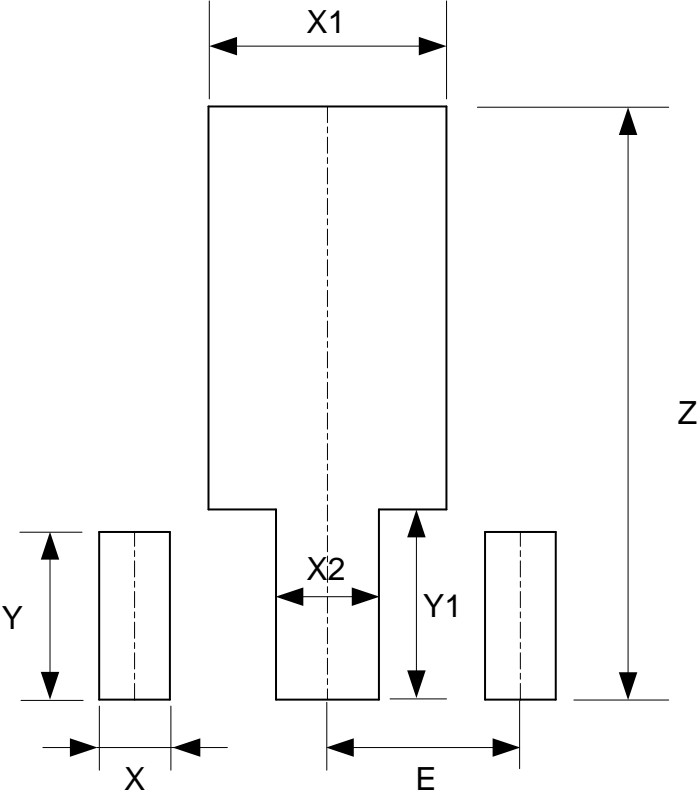

Dimensions	Z (mm)/(inch)	X (mm)/(inch)	X1 (mm)/(inch)	X2 (mm)/(inch)	Y (mm)/(inch)	Y1 (mm)/(inch)	E (mm)/(inch)
Value	4.600/0.181	0.550/0.022	1.850/0.073	0.800/0.031	1.300/0.051	1.475/0.058	1.500/0.059

IMPORTANT NOTICE

DIODES INCORPORATED MAKES NO WARRANTY OF ANY KIND, EXPRESS OR IMPLIED, WITH REGARDS TO THIS DOCUMENT, INCLUDING, BUT NOT LIMITED TO, THE IMPLIED WARRANTIES OF MERCHANTABILITY AND FITNESS FOR A PARTICULAR PURPOSE (AND THEIR EQUIVALENTS UNDER THE LAWS OF ANY JURISDICTION).

Diodes Incorporated and its subsidiaries reserve the right to make modifications, enhancements, improvements, corrections or other changes without further notice to this document and any product described herein. Diodes Incorporated does not assume any liability arising out of the application or use of this document or any product described herein; neither does Diodes Incorporated convey any license under its patent or trademark rights, nor the rights of others. Any Customer or user of this document or products described herein in such applications shall assume all risks of such use and will agree to hold Diodes Incorporated and all the companies whose products are represented on Diodes Incorporated website, harmless against all damages.

Diodes Incorporated does not warrant or accept any liability whatsoever in respect of any products purchased through unauthorized sales channel. Should Customers purchase or use Diodes Incorporated products for any unintended or unauthorized application, Customers shall indemnify and hold Diodes Incorporated and its representatives harmless against all claims, damages, expenses, and attorney fees arising out of, directly or indirectly, any claim of personal injury or death associated with such unintended or unauthorized application.

Products described herein may be covered by one or more United States, international or foreign patents pending. Product names and markings noted herein may also be covered by one or more United States, international or foreign trademarks.

This document is written in English but may be translated into multiple languages for reference. Only the English version of this document is the final and determinative format released by Diodes Incorporated.

LIFE SUPPORT

Diodes Incorporated products are specifically not authorized for use as critical components in life support devices or systems without the express written approval of the Chief Executive Officer of Diodes Incorporated. As used herein:

A. Life support devices or systems are devices or systems which:

1. are intended to implant into the body, or
2. support or sustain life and whose failure to perform when properly used in accordance with instructions for use provided in the labeling can be reasonably expected to result in significant injury to the user.

B. A critical component is any component in a life support device or system whose failure to perform can be reasonably expected to cause the failure of the life support device or to affect its safety or effectiveness.

Customers represent that they have all necessary expertise in the safety and regulatory ramifications of their life support devices or systems, and acknowledge and agree that they are solely responsible for all legal, regulatory and safety-related requirements concerning their products and any use of Diodes Incorporated products in such safety-critical, life support devices or systems, notwithstanding any devices- or systems-related information or support that may be provided by Diodes Incorporated. Further, Customers must fully indemnify Diodes Incorporated and its representatives against any damages arising out of the use of Diodes Incorporated products in such safety-critical, life support devices or systems.

Copyright © 2019, Diodes Incorporated

www.diodes.com

Looking for pricing, stock, or lifecycle information?

Click below to explore more details on WIN SOURCE:

 [View AP2139AK-1.5TRG1 on WIN SOURCE](#)

 [Diodes Incorporated](#) Information

Optimize Your Supply Chain with WIN SOURCE Solutions

-  Global Sourcing Solution
-  Obsolete Management
-  Cost Control Management
-  Shortage Management
-  Alternative Solution
-  Excess Inventory Management