

## General Description

The MIC5203 is a µCap 80mA linear voltage regulator with very low dropout voltage (typically 20mV at light loads and 300mV at 80mA) and very low ground current (225µA at 20mA output), offering better than 3% initial accuracy with a logic-compatible enable input.

The µCap regulator design is optimized to work with low-value, low-cost ceramic capacitors. The outputs typically require only 0.47µF of output capacitance for stability.

Designed especially for hand-held, battery-powered devices, the MIC5203 can be controlled by a CMOS or TTL compatible logic signal. When disabled, power consumption drops nearly to zero. If on-off control is not required, the enable pin may be tied to the input for 3-terminal operation. The ground current of the MIC5203 increases only slightly in dropout, further prolonging battery life. Key MIC5203 features include current limiting, overtemperature shutdown, and protection against reversed battery.

The MIC5203 is available in 2.8V, 3.0V, 3.3V, 3.6V, 3.8V, 4.0V, 4.5V, 4.75V, and 5.0V fixed voltages. Other voltages are available.

Data sheets and support documentation can be found on Micrel's web site at [www.micrel.com](http://www.micrel.com).

## Features

- Tiny 4- and 5-lead surface-mount packages
- Wide selection of output voltages
- Guaranteed 80mA output
- Low quiescent current
- Low dropout voltage
- Low temperature coefficient
- Current and thermal limiting
- Reversed input polarity protection
- Zero off-mode current
- Logic-controlled shutdown
- Stability with low-ESR ceramic capacitors

## Applications

- Cellular telephones
- Laptop, notebook, and palmtop computers
- Battery-powered equipment
- Barcode scanners
- SMPS post-regulator/DC-to-DC modules
- High-efficiency linear power supplies

## Typical Application



SOT-143 Version



SOT-23-5 Version

## Ordering Information<sup>(1)</sup>

| Part Number    |         |                |              | Voltage | Temperature Range | Package  |
|----------------|---------|----------------|--------------|---------|-------------------|----------|
| Standard       | Marking | Pb-Free        | Marking      |         |                   |          |
| MIC5203-2.6BM4 | LA26    | MIC5203-2.6YM4 | <u>LA</u> 26 | 2.6V    | -40° to +125°C    | SOT-143  |
| MIC5203-2.8BM4 | LA28    | MIC5203-2.8YM4 | <u>LA</u> 28 | 2.8V    | -40° to +125°C    | SOT-143  |
| MIC5203-3.0BM4 | LA30    | MIC5203-3.0YM4 | <u>LA</u> 30 | 3.0V    | -40° to +125°C    | SOT-143  |
| MIC5203-3.3BM4 | LA33    | MIC5203-3.3YM4 | <u>LA</u> 33 | 3.3V    | -40° to +125°C    | SOT-143  |
| MIC5203-3.6BM4 | LA36    | MIC5203-3.6YM4 | <u>LA</u> 36 | 3.6V    | -40° to +125°C    | SOT-143  |
| MIC5203-3.8BM4 | LA38    | MIC5203-3.8YM4 | <u>LA</u> 38 | 3.8V    | -40° to +125°C    | SOT-143  |
| MIC5203-4.0BM4 | LA40    | MIC5203-4.0YM4 | <u>LA</u> 40 | 4.0V    | -40° to +125°C    | SOT-143  |
| MIC5203-4.5BM4 | LA45    | MIC5203-4.5YM4 | <u>LA</u> 45 | 4.5V    | -40° to +125°C    | SOT-143  |
| MIC5203-4.7BM4 | LA47    | MIC5203-4.7YM4 | <u>LA</u> 47 | 4.7V    | -40° to +125°C    | SOT-143  |
| MIC5203-5.0BM4 | LA50    | MIC5203-5.0YM4 | <u>LA</u> 50 | 5.0V    | -40° to +125°C    | SOT-143  |
| MIC5203-2.6BM5 | LK26    | MIC5203-2.6YM5 | <u>LK</u> 26 | 2.6V    | -40° to +125°C    | SOT-23-5 |
| MIC5203-2.8BM5 | LK28    | MIC5203-2.8YM5 | <u>LK</u> 28 | 2.8V    | -40° to +125°C    | SOT-23-5 |
| MIC5203-3.0BM5 | LK30    | MIC5203-3.0YM5 | <u>LK</u> 30 | 3.0V    | -40° to +125°C    | SOT-23-5 |
| MIC5203-3.3BM5 | LK33    | MIC5203-3.3YM5 | <u>LK</u> 33 | 3.3V    | -40° to +125°C    | SOT-23-5 |
| MIC5203-3.6BM5 | LK36    | MIC5203-3.6YM5 | <u>LK</u> 36 | 3.6V    | -40° to +125°C    | SOT-23-5 |
| MIC5203-3.8BM5 | LK38    | MIC5203-3.8YM5 | <u>LK</u> 38 | 3.8V    | -40° to +125°C    | SOT-23-5 |
| MIC5203-4.0BM5 | LK40    | MIC5203-4.0YM5 | <u>LK</u> 40 | 4.0V    | -40° to +125°C    | SOT-23-5 |
| MIC5203-4.5BM5 | LK45    | MIC5203-4.5YM5 | <u>LK</u> 45 | 4.5V    | -40° to +125°C    | SOT-23-5 |
| MIC5203-4.7BM5 | LK47    | MIC5203-4.7YM5 | <u>LK</u> 47 | 4.7V    | -40° to +125°C    | SOT-23-5 |
| MIC5203-5.0BM5 | LK50    | MIC5203-5.0YM5 | <u>LK</u> 50 | 5.0V    | -40° to +125°C    | SOT-23-5 |

**Note:**

1. Other Voltage available. Contact Micrel for details.

## Pin Configuration

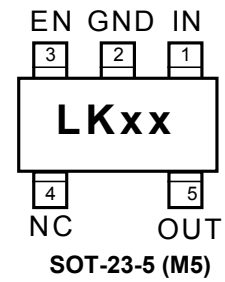
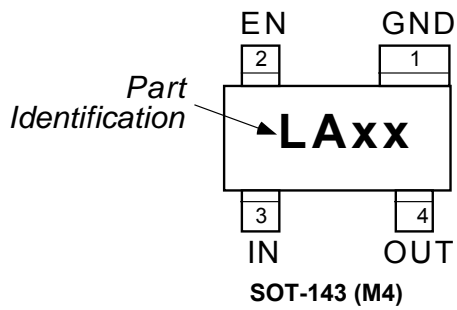

## Pin Description

| Pin Number<br>SOT-143 | Pin Number<br>SOT-23-5 | Pin Name | Pin Name   |
|-----------------------|------------------------|----------|--|
| 1                     | 2                      | GND      | Ground.  |
| 2                     | 3                      | EN       | Enable (Input): TTL/CMOS compatible control input. Logic high = enabled; logic low or open = shutdown. |
| 3                     | 1                      | IN       | Supply input.  |
|                       | 4                      | NC       | Not internally connected.  |
| 4                     | 5                      | OUT      | Regulator output.  |

**Absolute Maximum Ratings**<sup>(1)</sup>

|                                     |                    |
|-------------------------------------|--------------------|
| Supply Voltage ( $V_{IN}$ )         | –20V to +20V       |
| Enable Input Voltage ( $V_{EN}$ )   | –20V to +20V       |
| Power Dissipation ( $P_D$ )         | Internally Limited |
| Storage Temperature ( $T_s$ )       | –60°C to +150°C    |
| Lead Temperature (soldering, #sec.) | 260°C              |

**Operating Ratings**<sup>(2)</sup>

|                                      |                 |
|--------------------------------------|-----------------|
| Input Voltage ( $V_{IN}$ )           | 2.5V to 16V     |
| Enable Input Voltage ( $V_{EN}$ )    | 0V to $V_{IN}$  |
| Junction Temperature Range           | –40°C to +125°C |
| Thermal Resistance ( $\theta_{JA}$ ) | Note 3          |

**Electrical Characteristics**

$V_{IN} = V_{OUT} + 1V$ ;  $I_L = 1mA$ ;  $C_L = 0.47\mu F$ ;  $V_{EN} \geq 2.0V$ ;  $T_J = 25^\circ C$ , **bold** values indicate  $-40^\circ C \leq T_J \leq +125^\circ C$ , unless noted.

| Symbol                  | Parameter                              | Condition   | Min | Typ       | Max         | Units   |
|-------------------------|--|---|-----|-----------|-------------|---------|
| $V_O$                   | Output voltage accuracy                |   | –3  |           | 3           | %       |
|                         |  |   | –4  |           | 4           |         |
| $\Delta V_O/\Delta T$   | Output voltage temperature coefficient | Note 4  |     | <b>50</b> | <b>200</b>  | pm/°C   |
| $\Delta V_O/V_O$        | Line regulation                        | $V_{IN} = V_{OUT} + 1V$ to 16V                    |     | 0.008     | 0.3         | %       |
|                         |  |   |     |           | <b>0.5</b>  |         |
| $\Delta V_O/V_O$        | Load regulation                        | $I_L = 0.1mA$ to 80mA <sup>(5)</sup>              |     | 0.08      | 0.3         | %       |
|                         |  |   |     |           | 0.5         |         |
| $\Delta V_O - V_O$      | Dropout voltage <sup>(6)</sup>         | $I_L = 100 \mu A$                                 |     | 20        |             | mV      |
|                         |  | $I_L = 20mA$                                      |     | 200       | <b>350</b>  |         |
|                         |  | $I_L = 50mA$                                      |     | 250       |             |         |
|                         |  | $I_L = 80mA$                                      |     | 300       | <b>600</b>  |         |
| $I_Q$                   | Quiescent current                      | $V_{EN} \leq 0.4V$ (shutdown)                     |     | 0.01      | 10          | $\mu A$ |
| $I_{GND}$               | Ground pin current <sup>(7)</sup>      | $I_L = 100 \mu A$ , $V_{EN} \geq 2.0V$ (active)   |     | 180       |             | $\mu A$ |
|                         |  | $I_L = 20mA$ , $V_{EN} \geq 2.0V$ (active)        |     | 225       | <b>750</b>  |         |
|                         |  | $I_L = 50mA$ , $V_{EN} \geq 2.0V$ (active)        |     | 850       |             |         |
|                         |  | $I_L = 80mA$ , $V_{EN} \geq 2.0V$ (active)        |     | 1800      | <b>3000</b> |         |
| $I_{GNDDO}$             | Ground pin current at dropout          | $V_{IN} = V_{OUT(nominal)} - 0.5V$ <sup>(7)</sup> |     | 200       | <b>300</b>  | $\mu A$ |
| $I_{LIMIT}$             | Current limit                          | $V_{OUT} = 0V$                                    |     | 180       | <b>250</b>  | mA      |
| $\Delta V_O/\Delta P_D$ | Thermal regulation                     | Note 8  |     | 0.05      |             | %/W     |

## Electrical Characteristics (continued)

$V_{IN} = V_{OUT} + 1V$ ;  $I_L = 1mA$ ;  $C_L = 0.47\mu F$ ;  $V_{EN} \geq 2.0V$ ;  $T_J = 25^\circ C$ , **bold** values indicate  $-40^\circ C \leq T_J \leq +125^\circ C$ , unless noted.

| Symbol              | Parameter                  | Condition          | Min | Typ  | Max        | Units   |
|---------------------|----------------------------|--------------------|-----|------|------------|---------|
| <b>Enable Input</b> |                            |                    |     |      |            |         |
| $V_{IL}$            | Enable input voltage level | Logic low (off)    |     |      | <b>0.6</b> | V       |
| $V_{IH}$            |                            | Logic high (on)    | 2.0 |      |            |         |
| $I_{IL}$            | Enable input current       | $V_{IL} \leq 0.6V$ |     | 0.01 | 1          | $\mu A$ |
| $I_{IH}$            |                            | $V_{IH} \geq 2.0V$ |     | 15   | <b>50</b>  |         |

### Notes:

- Exceeding the absolute maximum rating may damage the device.
- The device is not guaranteed to function outside its operating rating.
- The maximum allowable power dissipation at any  $T_A$  (ambient temperature) is  $P_{D(MAX)} = (T_{J(MAX)} - T_A) \div \theta_{JA}$ . Exceeding the maximum allowable power dissipation will result in excessive die temperature, and the regulator will go into thermal shutdown. The  $\theta_{JA}$  is  $250^\circ C/W$  for the SOT-143 and  $220^\circ C/W$  for the SOT-23-5 mounted on a printed circuit board.
- Output voltage temperature coefficient is defined as the worst-case voltage change divided by the total temperature range.
- Regulation is measured at constant junction temperature using low duty cycle pulse testing. Parts are tested for load regulation in the load range from 0.1mA to 150mA. Changes in output voltage due to heating effects are covered by the thermal regulation specification.
- Dropout voltage is defined as the input-to-output differential at which the output voltage drops 2% below its nominal value measured at 1V differential.
- Ground pin current is the regulator quiescent current plus pass transistor base current. The total current drawn from the supply is the sum of the load current plus the ground pin current.
- Thermal regulation is defined as the change in output voltage at a time "t" after a change in power dissipation is applied, excluding load or line regulation effects. Specifications are for a 150mA load pulse at  $V_{IN} = 16V$  for  $t = 10ms$ .

# Typical Characteristics

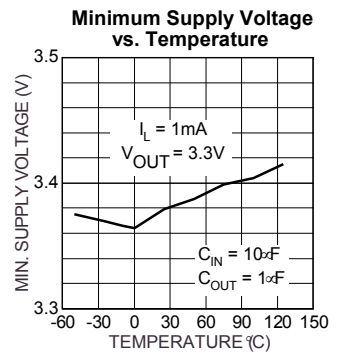
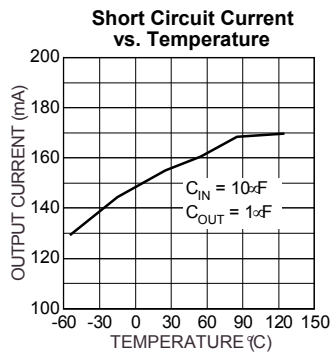
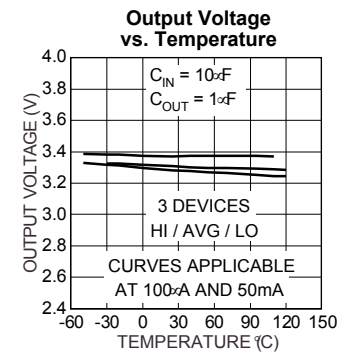
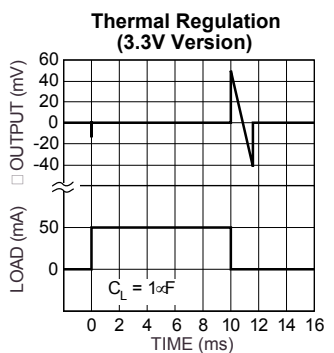
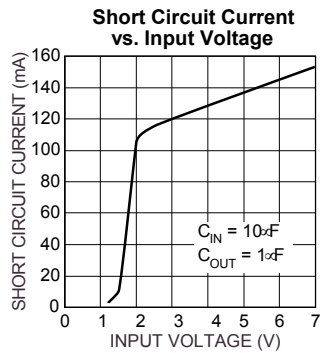
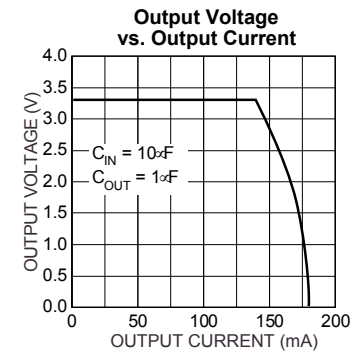
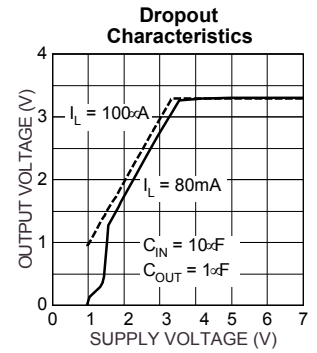
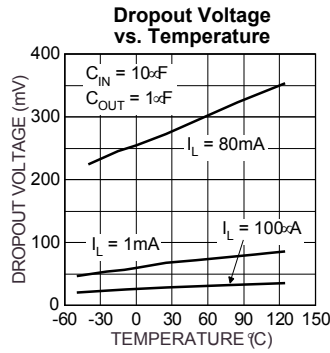
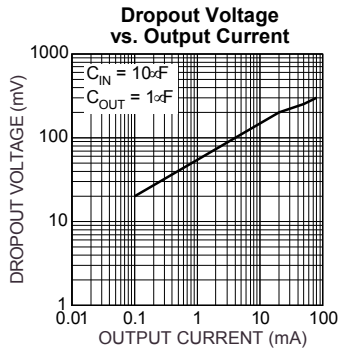

### Typical Characteristics (continued)

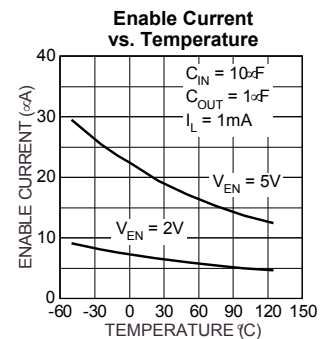
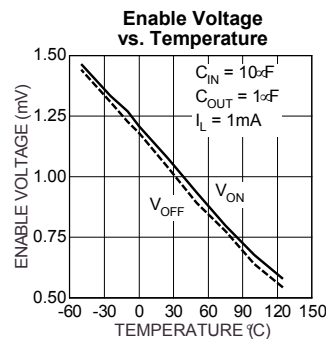
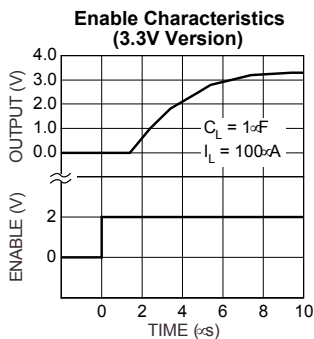
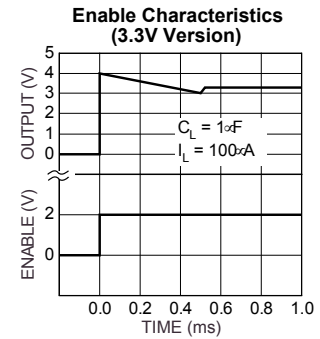
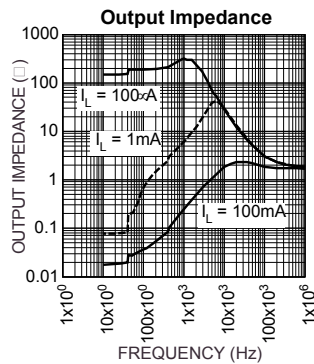
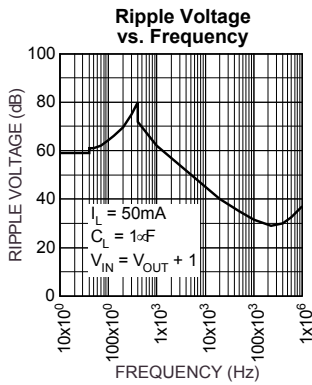
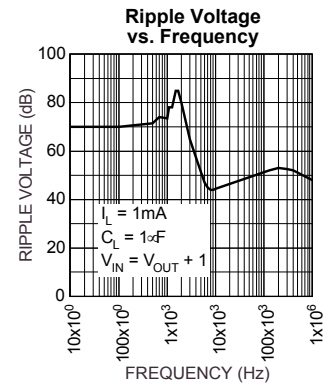
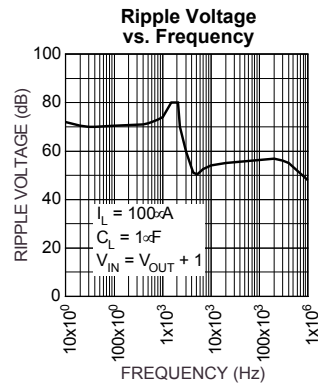
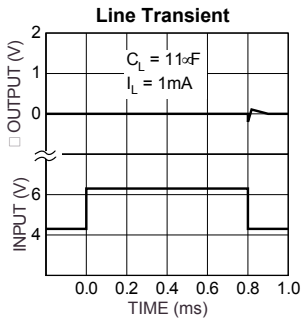
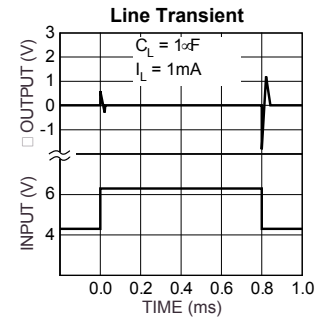
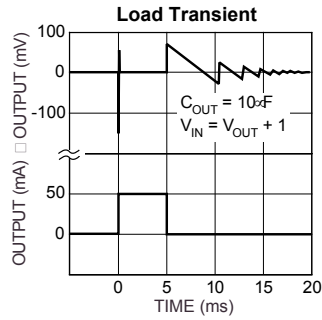
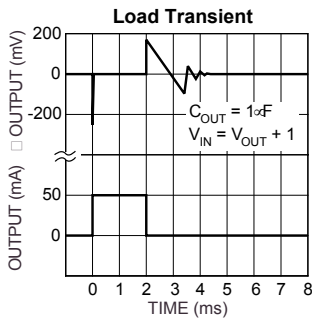

## Applications Information

### Input Capacitor

A 0.1 $\mu$ F capacitor should be placed from IN to GND if there is more than 10 inches of wire between the input and the AC filter capacitor or when a battery is used as the input.

### Output Capacitor

Typical PNP based regulators require an output capacitor to prevent oscillation. The MIC5203 is ultrastable, requiring only 0.47 $\mu$ F of output capacitance for stability. The regulator is stable with all types of capacitors, including the tiny, low-ESR ceramic chip capacitors. The output capacitor value can be increased without limit to improve transient response.

The capacitor should have a resonant frequency above 500kHz. Ceramic capacitors work, but some dielectrics have poor temperature coefficients, which will affect the value of the output capacitor over temperature. Tantalum capacitors are much more stable over temperature, but typically are larger and more expensive. Aluminum electrolytic capacitors will also work, but they have electrolytes that freeze at about  $-30^{\circ}\text{C}$ . Tantalum or ceramic capacitors are recommended for operation below  $-25^{\circ}\text{C}$ .

### No-Load Stability

The MIC5203 will remain stable and in regulation with no load (other than the internal voltage divider) unlike many other voltage regulators. This is especially important in CMOS RAM keep-alive applications.

### Enable Input

The MIC5203 features nearly zero off-mode current. When EN (enable input) is held below 0.6V, all internal circuitry is powered off. Pulling EN high (over 2.0V) re-enables the device and allows operation. EN draws a small amount of current, typically 15 $\mu$ A. While the logic threshold is TTL/CMOS compatible, EN may be pulled as high as 20V, independent of  $V_{\text{IN}}$ .

**Package Information**



**SOT-143 (M4)**

**Package Information (continued)**



**SOT-23-5 (M5)**

**MICREL, INC. 2180 FORTUNE DRIVE SAN JOSE, CA 95131 USA**  
 TEL +1 (408) 944-0800 FAX +1 (408) 474-1000 WEB <http://www.micrel.com>

The information furnished by Micrel in this data sheet is believed to be accurate and reliable. However, no responsibility is assumed by Micrel for its use. Micrel reserves the right to change circuitry and specifications at any time without notification to the customer.

Micrel Products are not designed or authorized for use as components in life support appliances, devices or systems where malfunction of a product can reasonably be expected to result in personal injury. Life support devices or systems are devices or systems that (a) are intended for surgical implant into the body or (b) support or sustain life, and whose failure to perform can be reasonably expected to result in a significant injury to the user. A Purchaser's use or sale of Micrel Products for use in life support appliances, devices or systems is a Purchaser's own risk and Purchaser agrees to fully indemnify Micrel for any damages resulting from such use or sale.

© 1998 Micrel, Incorporated.

## Looking for pricing, stock, or lifecycle information?

Click below to explore more details on WIN SOURCE:

- ⊖ [View MIC5203-2.8YM4-TR on WIN SOURCE](#)
- ⊖ [Microchip Technology](#) Information

## Optimize Your Supply Chain with WIN SOURCE Solutions

- ✓ Global Sourcing Solution
- ✓ Obsolete Management
- ✓ Cost Control Management
- ✓ Shortage Management
- ✓ Alternative Solution
- ✓ Excess Inventory Management