



**THE DATASHEET OF
SM5S14AHE3/2D**



Surface Mount PAR[®] Transient Voltage Suppressors

High Temperature Stability and High Reliability Conditions



DO-218AB

PRIMARY CHARACTERISTICS	
V_{WM}	10 V to 36 V
V_{BR}	11.1 V to 44.2 V
P_{PPM} (10 x 1000 μ s)	3600 W
P_{PPM} (10 x 10 000 μ s)	2800 W
P_D	5 W
I_{FSM}	500 A
T_J max.	175 °C
Polarity	Uni-directional
Package	DO-218AB

FEATURES

- Junction passivation optimized design passivated anisotropic rectifier technology
- $T_J = 175$ °C capability suitable for high reliability and automotive requirement
- Available in uni-directional polarity only
- Low leakage current
- Low forward voltage drop
- High surge capability
- Meets ISO7637-2 surge specification (varied by test condition)
- Meets MSL level 1, per J-STD-020, LF maximum peak of 245 °C
- AEC-Q101 qualified
- Material categorization: for definitions of compliance please see www.vishay.com/doc?99912



RoHS
COMPLIANT

TYPICAL APPLICATIONS

Use in sensitive electronics protection against voltage transients induced by inductive load switching and lighting, especially for automotive load dump protection application.

MECHANICAL DATA

Case: DO-218AB

Molding compound meets UL 94 V-0 flammability rating
 Base P/NHE3 - RoHS-compliant, AEC-Q101 qualified
 Base P/NHE3_X - RoHS-compliant and AEC-Q101 qualified
 ("X" denotes revision code e.g. A, B, ..., revision code only applicable for part number with ± 5 % tolerance)

Terminals: matte tin plated leads, solderable per J-STD-002 and JESD 22-B102

HE3 suffix meets JESD 201 class 2 whisker test

Polarity: heatsink is anode

MAXIMUM RATINGS ($T_A = 25$ °C unless otherwise noted)			
PARAMETER	SYMBOL	VALUE	UNIT
Peak pulse power dissipation	P_{PPM}	with 10/1000 μ s waveform	3600
		with 10/10 000 μ s waveform	2800
Power dissipation on infinite heatsink at $T_C = 25$ °C (fig. 1)	P_D	5.0	W
Peak pulse current with 10/1000 μ s waveform	$I_{PPM}^{(1)}$	See next table	A
Peak forward surge current 8.3 ms single half sine-wave	I_{FSM}	500	A
Operating junction and storage temperature range	T_J, T_{STG}	-55 to +175	°C

Note

⁽¹⁾ Non-repetitive current pulse at $T_A = 25$ °C



ELECTRICAL CHARACTERISTICS ($T_A = 25\text{ }^\circ\text{C}$ unless otherwise noted)								
DEVICE TYPE	BREAKDOWN VOLTAGE V_{BR} (V)		TEST CURRENT I_T (mA)	STAND-OFF VOLTAGE V_{WM} (V)	MAXIMUM REVERSE LEAKAGE AT V_{WM} I_D (μA)	MAXIMUM REVERSE LEAKAGE AT V_{WM} $T_J = 175\text{ }^\circ\text{C}$ I_D (μA)	MAX. PEAK PULSE CURRENT AT 10/1000 μs WAVEFORM (A)	MAXIMUM CLAMPING VOLTAGE AT I_{PPM} V_C (V)
	MIN.	MAX.						
SM5S10	11.1	13.6	5.0	10.0	15	250	191	18.8
SM5S10A	11.1	12.3	5.0	10.0	15	250	212	17.0
SM5S11	12.2	14.9	5.0	11.0	10	150	179	20.1
SM5S11A	12.2	13.5	5.0	11.0	10	150	198	18.2
SM5S12	13.3	16.3	5.0	12.0	10	150	164	22.0
SM5S12A	13.3	14.7	5.0	12.0	10	150	181	19.9
SM5S13	14.4	17.6	5.0	13.0	10	150	151	23.8
SM5S13A	14.4	15.9	5.0	13.0	10	150	167	21.5
SM5S14	15.6	19.1	5.0	14.0	10	150	140	25.8
SM5S14A	15.6	17.2	5.0	14.0	10	150	155	23.2
SM5S15	16.7	20.4	5.0	15.0	10	150	134	26.9
SM5S15A	16.7	18.5	5.0	15.0	10	150	148	24.4
SM5S16	17.8	21.8	5.0	16.0	10	150	125	28.8
SM5S16A	17.8	19.7	5.0	16.0	10	150	138	26.0
SM5S17	18.9	23.1	5.0	17.0	10	150	118	30.5
SM5S17A	18.9	20.9	5.0	17.0	10	150	130	27.6
SM5S18	20.0	24.4	5.0	18.0	10	150	112	32.2
SM5S18A	20.0	22.1	5.0	18.0	10	150	123	29.2
SM5S20	22.2	27.1	5.0	20.0	10	150	101	35.8
SM5S20A	22.2	24.5	5.0	20.0	10	150	111	32.4
SM5S22	24.4	29.8	5.0	22.0	10	150	91	39.4
SM5S22A	24.4	26.9	5.0	22.0	10	150	101	35.5
SM5S24	26.7	32.6	5.0	24.0	10	150	84	43.0
SM5S24A	26.7	29.5	5.0	24.0	10	150	93	38.9
SM5S26	28.9	35.3	5.0	26.0	10	150	77	46.6
SM5S26A	28.9	31.9	5.0	26.0	10	150	86	42.1
SM5S28	31.1	38.0	5.0	28.0	10	150	72	50.1
SM5S28A	31.1	34.4	5.0	28.0	10	150	79	45.4
SM5S30	33.3	40.7	5.0	30.0	10	150	67	53.5
SM5S30A	33.3	36.8	5.0	30.0	10	150	74	48.4
SM5S33	36.7	44.9	5.0	33.0	10	150	61	59.0
SM5S33A	36.7	40.6	5.0	33.0	10	150	68	53.3
SM5S36	40.0	48.9	5.0	36.0	10	150	56	64.3
SM5S36A	40.0	44.2	5.0	36.0	10	150	62	58.1

Note

- For all types maximum $V_F = 2.0\text{ V}$ at $I_F = 100\text{ A}$ measured on 8.3 ms single half sine-wave or equivalent square wave, duty cycle = 4 pulses per minute maximum

THERMAL CHARACTERISTICS ($T_A = 25\text{ }^\circ\text{C}$ unless otherwise noted)			
PARAMETER	SYMBOL	VALUE	UNIT
Typical thermal resistance, junction to case	$R_{\theta JC}$	1.0	$^\circ\text{C/W}$

ORDERING INFORMATION (Example)				
PREFERRED P/N	UNIT WEIGHT (g)	PREFERRED PACKAGE CODE	BASE QUANTITY	DELIVERY MODE
SM5S10AHE3/2D ⁽¹⁾	2.505	2D	750	13" diameter plastic tape and reel, anode towards the sprocket hole
SM5S10AHE3_A/I ⁽¹⁾	2.505	I	750	13" diameter plastic tape and reel, anode towards the sprocket hole

Note

- ⁽¹⁾ AEC-Q101 qualified



RATINGS AND CHARACTERISTICS CURVES ($T_A = 25\text{ }^\circ\text{C}$ unless otherwise noted)

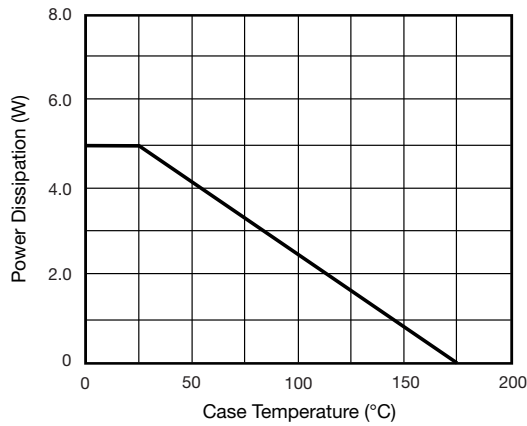

Fig. 1 - Power Derating Curve

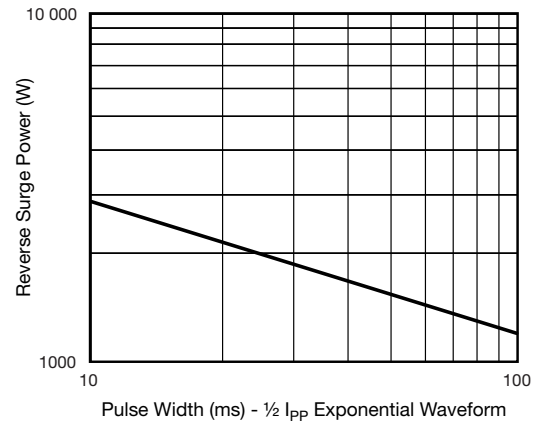

Fig. 4 - Reverse Power Capability

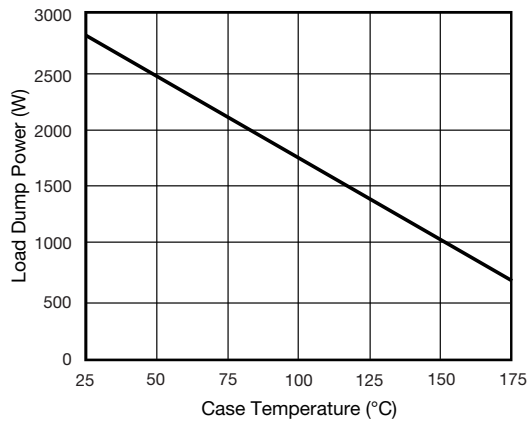

Fig. 2 - Load Dump Power Characteristics (10 ms Exponential Waveform)

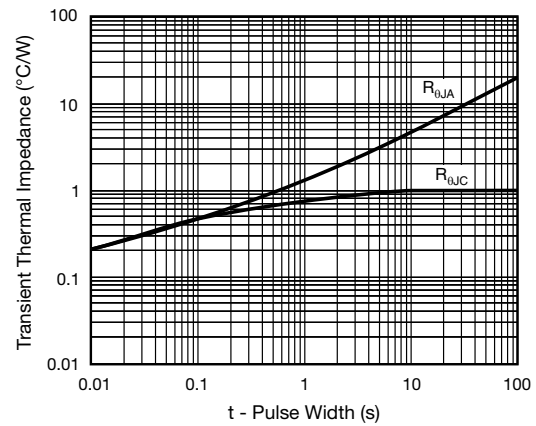

Fig. 5 - Typical Transient Thermal Impedance

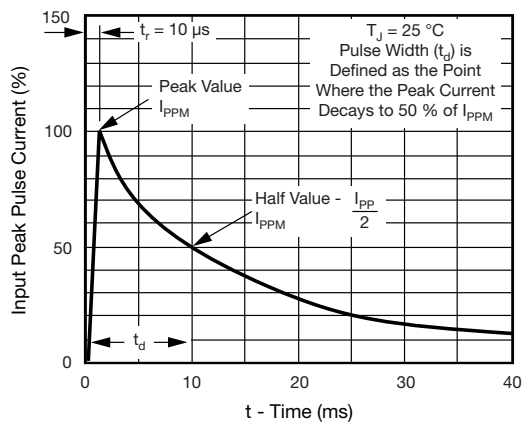
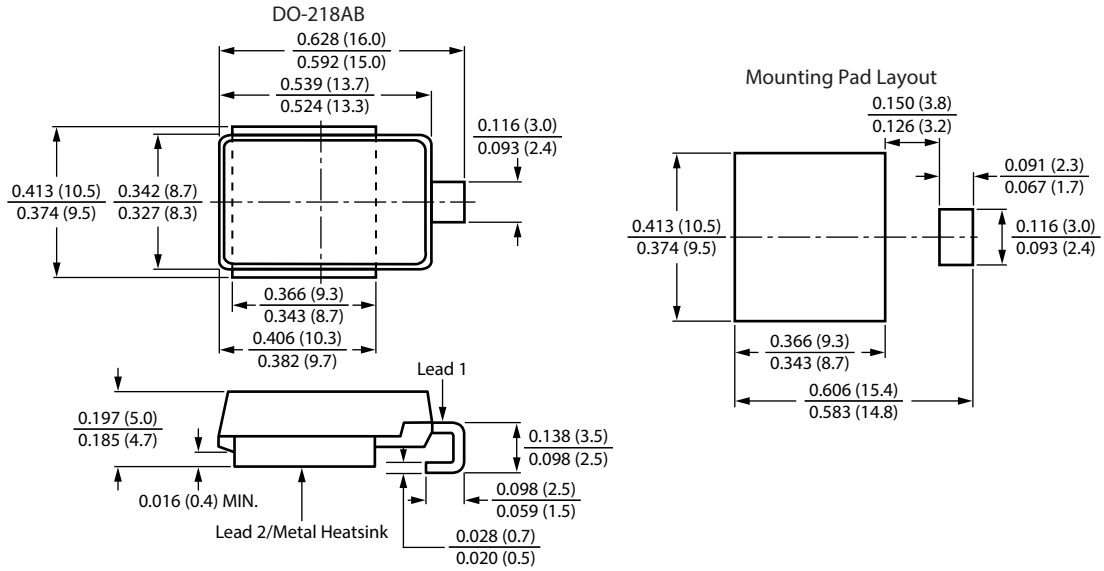

Fig. 3 - Pulse Waveform



PACKAGE OUTLINE DIMENSIONS in inches (millimeters)





Disclaimer

ALL PRODUCT, PRODUCT SPECIFICATIONS AND DATA ARE SUBJECT TO CHANGE WITHOUT NOTICE TO IMPROVE RELIABILITY, FUNCTION OR DESIGN OR OTHERWISE.

Vishay Intertechnology, Inc., its affiliates, agents, and employees, and all persons acting on its or their behalf (collectively, "Vishay"), disclaim any and all liability for any errors, inaccuracies or incompleteness contained in any datasheet or in any other disclosure relating to any product.

Vishay makes no warranty, representation or guarantee regarding the suitability of the products for any particular purpose or the continuing production of any product. To the maximum extent permitted by applicable law, Vishay disclaims (i) any and all liability arising out of the application or use of any product, (ii) any and all liability, including without limitation special, consequential or incidental damages, and (iii) any and all implied warranties, including warranties of fitness for particular purpose, non-infringement and merchantability.

Statements regarding the suitability of products for certain types of applications are based on Vishay's knowledge of typical requirements that are often placed on Vishay products in generic applications. Such statements are not binding statements about the suitability of products for a particular application. It is the customer's responsibility to validate that a particular product with the properties described in the product specification is suitable for use in a particular application. Parameters provided in datasheets and / or specifications may vary in different applications and performance may vary over time. All operating parameters, including typical parameters, must be validated for each customer application by the customer's technical experts. Product specifications do not expand or otherwise modify Vishay's terms and conditions of purchase, including but not limited to the warranty expressed therein.

Except as expressly indicated in writing, Vishay products are not designed for use in medical, life-saving, or life-sustaining applications or for any other application in which the failure of the Vishay product could result in personal injury or death. Customers using or selling Vishay products not expressly indicated for use in such applications do so at their own risk. Please contact authorized Vishay personnel to obtain written terms and conditions regarding products designed for such applications.

No license, express or implied, by estoppel or otherwise, to any intellectual property rights is granted by this document or by any conduct of Vishay. Product names and markings noted herein may be trademarks of their respective owners.

Looking for pricing, stock, or lifecycle information?

Click below to explore more details on WIN SOURCE:

 [View SM5S14AHE3/2D on WIN SOURCE](#)

 [Vishay Information](#)

Optimize Your Supply Chain with WIN SOURCE Solutions

-  Global Sourcing Solution
-  Obsolete Management
-  Cost Control Management
-  Shortage Management
-  Alternative Solution
-  Excess Inventory Management