



**THE DATASHEET OF
MIC5305-1.8BD5**





MIC5305

150mA μ Cap Ultra-Low Dropout LDO Regulator

General Description

The MIC5305 is a high-performance, 150mA LDO regulator, offering extremely high PSRR and very low noise while consuming low ground current.

Ideal for battery-operated applications, the MIC5305 features 1% accuracy, extremely low-dropout voltage (60mV @ 150mA), and low ground current at light load (typically 90 μ A). Equipped with a logic-compatible enable pin, the MIC5305 can be put into a zero-off-mode current state, drawing no current when disabled.

The MIC5305 is a μ Cap design operating with very small ceramic output capacitors for stability, thereby reducing required board space and component cost.

The MIC5305 is available in fixed output voltages and adjustable output voltages in the super-compact 6-pin 2mm \times 2mm MLF[®] leadless package, our new ultra-thin 6-pin 2mm \times 2mm Thin MLF[®] and thin SOT-23-5 package. Additional voltage options are available. Contact Micrel marketing.

Data sheets and support documentation can be found on Micrel's web site at www.micrel.com.

Features

- Ultra-low dropout voltage of 60mV @ 150mA
- Input voltage range: 2.25 to 5.5V
- Stable with ceramic output capacitor
- 150mA guaranteed output current
- Low output noise — 20 μ Vrms
- Low quiescent current of 90 μ A total
- High PSRR, up to 85dB @1kHz
- Less than 30 μ s turn-on time w/ $C_{BYP} = 0.01\mu$ F
- High output accuracy:
 - $\pm 1.0\%$ initial accuracy
 - $\pm 2.0\%$ over temperature
- Thermal shutdown protection
- Current limit protection
- Tiny 6-pin 2mm \times 2mm MLF[®] package
- Ultra-Thin 6-pin 2mm \times 2mm Thin MLF[®] package
- Thin SOT-23-5 package

Applications

- Cellular phones
- PDAs
- Fiber optic modules
- Portable electronics
- Notebook PCs
- Audio Codec power supplies

Typical Application

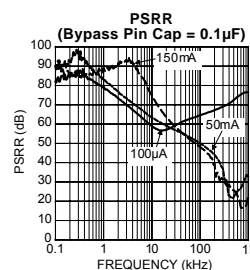
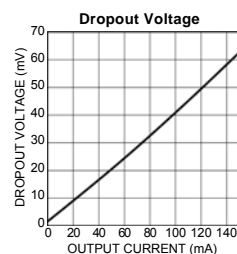
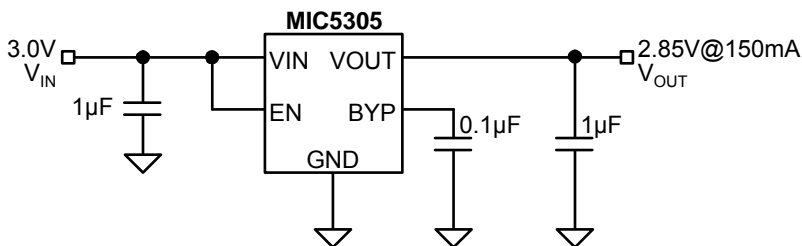

MLF and MicroLeadFrame are registered trademarks of Amkor Technology, Inc.

Micrel Inc. • 2180 Fortune Drive • San Jose, CA 95131 • USA • tel +1 (408) 944-0800 • fax + 1 (408) 474-1000 • <http://www.micrel.com>

Ordering Information

| Part Number | | Marking | | Voltage | Junction Temp. Range ⁽¹⁾ | Package |
|-----------------|-----------------|----------|-------------|---------|-------------------------------------|---------------------------------|
| Standard | Pb-Free | Standard | Pb-Free* | | | |
| MIC5305-1.5BML | MIC5305-1.5YML | 815 | <u>815</u> | 1.5V | -40°C to +125°C | 6-Pin 2x2 MLF [®] |
| MIC5305-1.8BML | MIC5305-1.8YML | 818 | <u>818</u> | 1.8V | -40°C to +125°C | 6-Pin 2x2 MLF [®] |
| | MIC5305-2.0YML | | <u>820</u> | 2.0V | -40°C to +125°C | 6-Pin 2x2 MLF [®] |
| MIC5305-2.5BML | MIC5305-2.5YML | 825 | <u>825</u> | 2.5V | -40°C to +125°C | 6-Pin 2x2 MLF [®] |
| MIC5305-2.6BML | MIC5305-2.6YML | 826 | <u>826</u> | 2.6V | -40°C to +125°C | 6-Pin 2x2 MLF [®] |
| MIC5305-2.7BML | MIC5305-2.7YML | 827 | <u>827</u> | 2.7V | -40°C to +125°C | 6-Pin 2x2 MLF [®] |
| MIC5305-2.8BML | MIC5305-2.8YML | 828 | <u>828</u> | 2.8V | -40°C to +125°C | 6-Pin 2x2 MLF [®] |
| MIC5305-2.85BML | MIC5305-2.85YML | 82J | <u>82J</u> | 2.85V | -40°C to +125°C | 6-Pin 2x2 MLF [®] |
| MIC5305-2.9BML | MIC5305-2.9YML | 829 | <u>829</u> | 2.9V | -40°C to +125°C | 6-Pin 2x2 MLF [®] |
| MIC5305-3.0BML | MIC5305-3.0YML | 830 | <u>830</u> | 3.0V | -40°C to +125°C | 6-Pin 2x2 MLF [®] |
| MIC5305-3.3BML | MIC5305-3.3YML | 833 | <u>833</u> | 3.3V | -40°C to +125°C | 6-Pin 2x2 MLF [®] |
| MIC5305-4.75BML | MIC5305-4.75YML | 84H | <u>84H</u> | 4.75V | -40°C to +125°C | 6-Pin 2x2 MLF [®] |
| MIC5305BML | MIC5305YML | 8AA | <u>8AA</u> | ADJ | -40°C to +125°C | 6-Pin 2x2 MLF [®] |
| | MIC5305-2.8YMT | | 828** | 2.8V | -40°C to +125°C | 6-Pin 2x2 Thin MLF [®] |
| | MIC5305-4.6YMT | | 846** | 4.6V | -40°C to +125°C | 6-Pin 2x2 Thin MLF [®] |
| MIC5305-1.5BD5 | MIC5305-1.5YD5 | N815 | <u>N815</u> | 1.5V | -40°C to +125°C | Thin SOT23-5 |
| MIC5305-1.8BD5 | MIC5305-1.8YD5 | N818 | <u>N818</u> | 1.8V | -40°C to +125°C | Thin SOT23-5 |
| MIC5305-2.5BD5 | MIC5305-2.5YD5 | N825 | <u>N825</u> | 2.5V | -40°C to +125°C | Thin SOT23-5 |
| MIC5305-2.6BD5 | MIC5305-2.6YD5 | N826 | <u>N826</u> | 2.6V | -40°C to +125°C | Thin SOT23-5 |
| MIC5305-2.7BD5 | MIC5305-2.7YD5 | N827 | <u>N827</u> | 2.7V | -40°C to +125°C | Thin SOT23-5 |
| MIC5305-2.8BD5 | MIC5305-2.8YD5 | N828 | <u>N828</u> | 2.8V | -40°C to +125°C | Thin SOT23-5 |
| MIC5305-2.85BD5 | MIC5305-2.85YD5 | N82J | <u>N82J</u> | 2.85V | -40°C to +125°C | Thin SOT23-5 |
| MIC5305-2.9BD5 | MIC5305-2.9YD5 | N829 | <u>N829</u> | 2.9V | -40°C to +125°C | Thin SOT23-5 |
| MIC5305-3.0BD5 | MIC5305-3.0YD5 | N830 | <u>N830</u> | 3.0V | -40°C to +125°C | Thin SOT23-5 |
| MIC5305-3.3BD5 | MIC5305-3.3YD5 | N833 | <u>N833</u> | 3.3V | -40°C to +125°C | Thin SOT23-5 |
| MIC5305-4.75BD5 | MIC5305-4.75YD5 | N84H | <u>N84H</u> | 4.75V | -40°C to +125°C | Thin SOT23-5 |

Note:

1. For other output voltage options, contact Micrel marketing.

* Underbar/Overbar symbols may not be to scale.

** Pin 1 identifier for 2x2 Thin MLF[®] is "▲" symbol.

Pin Configuration



MIC5305-x.xBML/YML (Fixed)
6-Pin 2mm x 2mm MLF® (ML)
 (Top View)



MIC5305-x.xBML/YML (Adjustable)
6-Pin 2mm x 2mm MLF® (ML)
 (Top View)



MIC5305-x.xYMT (Fixed)
6-Pin 2mm x 2mm Thin MLF® (MT)
 (Top View)



MIC5305-x.xBD5/YD5 (Fixed)
TSOT-23-5 (D5)
 (Top View)

Pin Description

| Pin Number MLF-6 Fixed | Pin Number MLF-6 Adjustable | Pin Number Thin MLF-6 Fixed | Pin Number TSOT23-5 Fixed | Pin Name | Pin Name |
|------------------------------|-----------------------------------|-----------------------------------|---------------------------------|----------|---------------------------------------------------------------------------------------------|
| 1 | 1 | 1 | 3 | EN | Enable Input. Active High. High = on, low = off. Do not leave floating. |
| 2 | 2 | 2 | 2 | GND | Ground. |
| 3 | 3 | 3 | 1 | VIN | Supply Input. |
| 4 | 4 | 4 | 5 | VOUT | Output Voltage. |
| – | 5 | – | – | ADJ | Adjust Input: Connect to external resistor voltage divider network. |
| 5 | – | 5 | – | NC | No connection for fixed voltage parts. |
| 6 | 6 | 6 | 4 | BYP | Reference Bypass: Connect external 0.1µF to GND for reduced output noise. May be left open. |
| HS Pad | HS Pad | HS Pad | – | EPAD | Exposed Heatsink Pad connected to ground internally. |

Absolute Maximum Ratings⁽¹⁾

| | |
|-------------------------------------|-----------------------------------|
| Supply Voltage (V_{IN}) | 0V to 6V |
| Enable Input Voltage (V_{EN}) | 0V to 6V |
| Power Dissipation (P_D) | Internally Limited ⁽³⁾ |
| Junction Temperature (T_J) | -40°C to +125°C |
| Lead Temperature (soldering, 5sec.) | 260°C |
| Storage Temperature (T_S) | -65°C to +150°C |
| ESD Rating ⁽⁴⁾ | 2kV |

Operating Ratings⁽²⁾

| | |
|-----------------------------------|-----------------|
| Supply voltage (V_{IN}) | 2.25V to 5.5V |
| Enable Input Voltage (V_{EN}) | 0V to V_{IN} |
| Junction Temperature (T_J) | -40°C to +125°C |
| Junction Thermal Resistance | |
| MLF-6 (θ_{JA}) | 93°C/W |
| Thin MLF-6 (θ_{JA}) | 93°C/W |
| TSOT-23-5 (θ_{JA}) | 235°C/W |

Electrical Characteristics⁽⁵⁾

$V_{IN} = V_{OUT} + 1.0V$; $C_{OUT} = 1.0\mu F$; $I_{OUT} = 100\mu A$; $T_J = 25^\circ C$, **bold** values indicate -40°C to +125°C, unless noted.

| Parameter | Condition | Min | Typ | Max | Units |
|-----------------------------------|----------------------------------------------------------------------|-------------|------|-------------|---------------|
| Output Voltage Accuracy | Variation from nominal V_{OUT} | -1.0 | | +1.0 | % |
| | Variation from nominal V_{OUT} , $I_{OUT} = 100mA$ to 150mA | -2.0 | | +2.0 | % |
| Output Voltage Temp. Coefficient | | | 40 | | pm/°C |
| Line Regulation | $V_{IN} = V_{OUT} + 1V$ to 5.5V | | 0.02 | 0.3 | %/V |
| Load Regulation ⁽⁶⁾ | $I_{OUT} = 100\mu A$ to 150mA | | 0.1 | 0.5 | % |
| Dropout Voltage ⁽⁷⁾ | $I_{OUT} = 50mA$, $V_{OUT} > 2.8V$ | | 20 | 35 | mV |
| | $I_{OUT} = 150mA$, $V_{OUT} > 2.8V$ | | 60 | 85 | mV |
| | $I_{OUT} = 50mA$, $V_{OUT} > 2.8V$ | | 27 | 45 | mV |
| | $I_{OUT} = 150mA$, $V_{OUT} > 2.8V$ | | 85 | 110 | mV |
| Ground Pin Current ⁽⁸⁾ | $I_{OUT} = 0$ to 150mA | | 90 | 150 | μA |
| Ground Pin Current in Shutdown | $V_{EN} \leq 0.2V$ | | 0.5 | | μA |
| Ripple Rejection | $f =$ up to 1kHz; $C_{OUT} = 1.0\mu F$ ceramic; $C_{BYP} = 0.1\mu F$ | | 85 | | dB |
| | $f = 10kHz$; $C_{OUT} = 1.0\mu F$ ceramic; $C_{BYP} = 0.1\mu F$ | | 65 | | dB |
| Current Limit | $V_{OUT} = 0V$ | 300 | 600 | 900 | mA |
| Output Voltage Noise | $C_{OUT} = 1\mu F$, $C_{BYP} = 0.1\mu F$, 10Hz to 100kHz | | 20 | | μV_{rms} |
| Turn-On Time | $C_{OUT} = 1\mu F$; $C_{BYP} = 0.1\mu F$; $I_{OUT} = 150mA$ | | 30 | 100 | μs |
| Enable Input | | | | | |
| Enable Input Voltage | Logic Low (Regulator Shutdown) | | | 0.2 | V |
| | Logic High (Regulator Enabled) | 1.0 | | | V |
| Enable Input Current | $V_{IL} \leq 0.2V$ (Regulator Shutdown) | | 0.01 | 1 | μA |
| | $V_{IH} \geq 1.0V$ (Regulator Enabled) | | 0.01 | 1 | μA |

Notes:

- Exceeding the absolute maximum rating may damage the device.
- The device is not guaranteed to function outside its operating rating.
- The maximum allowable power dissipation of any T_A (ambient temperature) is $P_{D(max)} = (T_{J(max)} - T_A) / \theta_{JA}$. Exceeding the maximum allowable power dissipation will result in excessive die temperature, and the regulator will go into thermal shutdown.
- Devices are ESD sensitive. Handling precautions recommended. Human body model.
- Specification for packaged product only.
- Regulation is measured at constant junction temperature using low duty cycle pulse testing, changes in output voltage due to heating effects are covered by the thermal regulation specification.
- Dropout voltage is defined as the input-to-output differential at which the output voltage drops 2% below its nominal V_{OUT} . For outputs below 2.25V, dropout voltage is the input-to-output differential with the minimum input voltage 2.25V.
- Ground pin current is the regulator quiescent current. The total current drawn from the supply is the sum of the load current plus the ground pin current.

Typical Characteristics

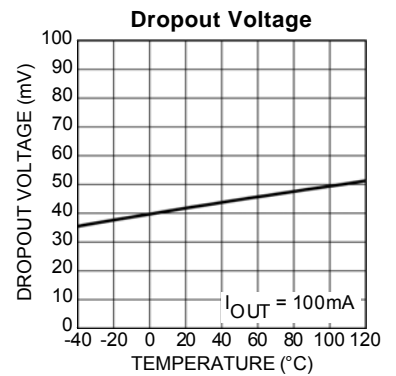
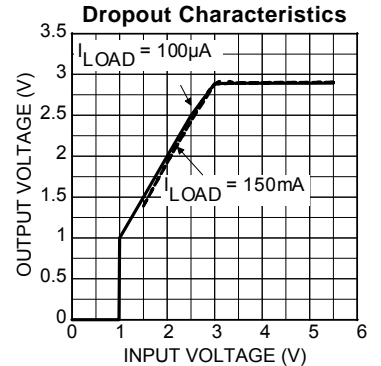
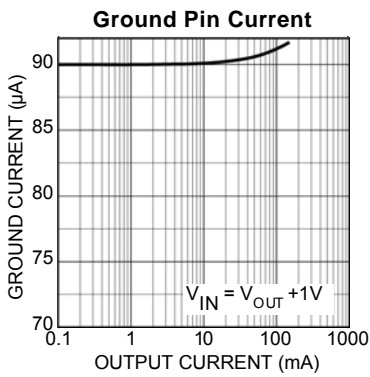
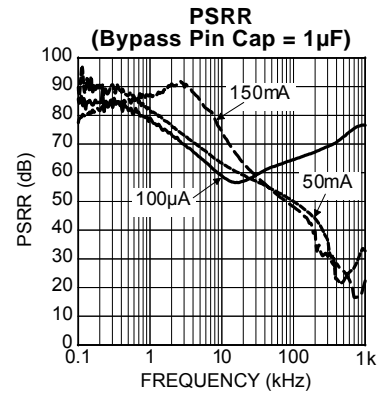
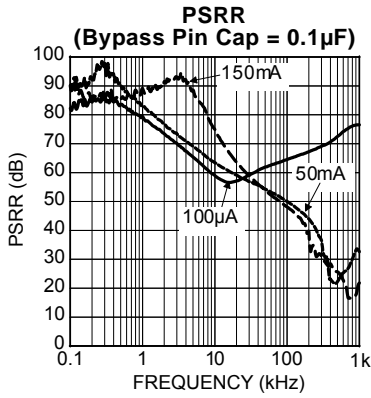
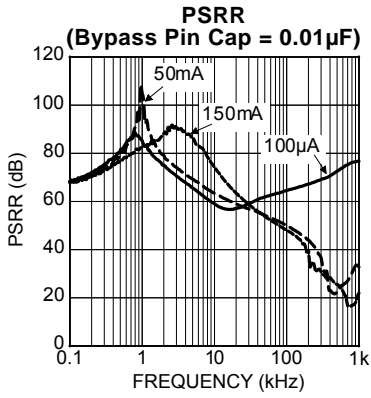

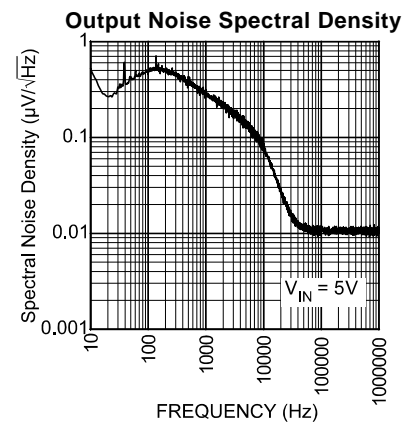

Functional Characteristics

Line Transient Response

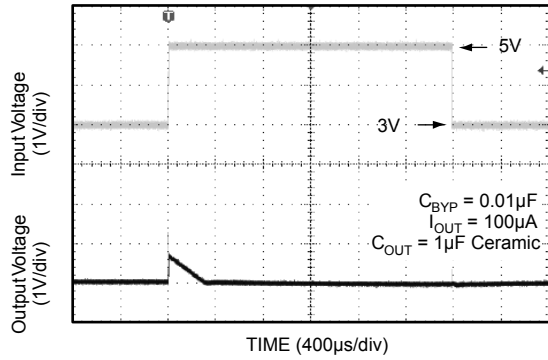

Load Transient Response



Enable Pin Delay

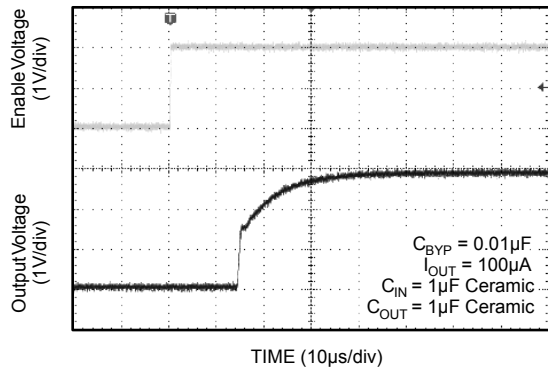

Shutdown Delay

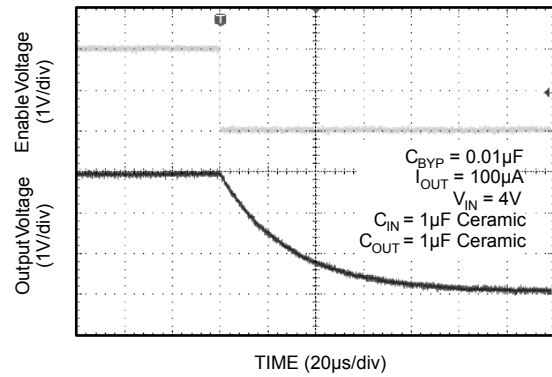

Functional Diagram

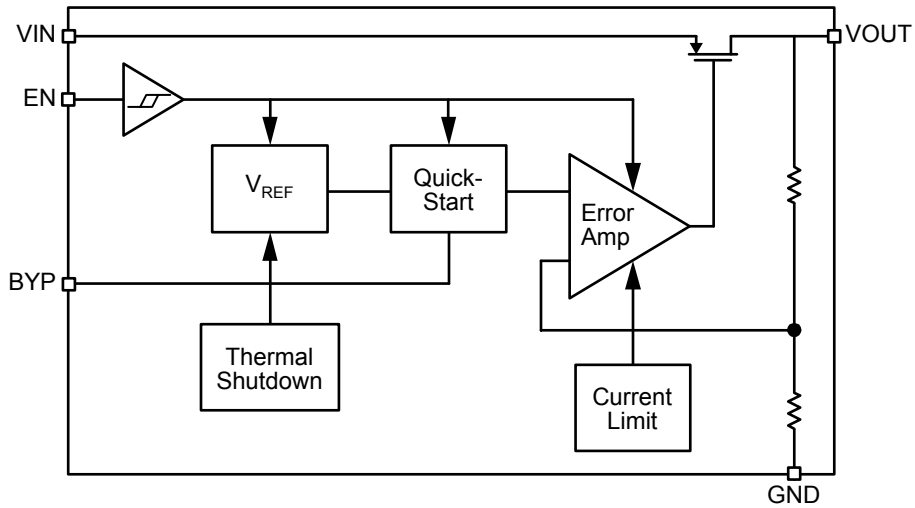

MIC5305 Block Diagram – Fixed

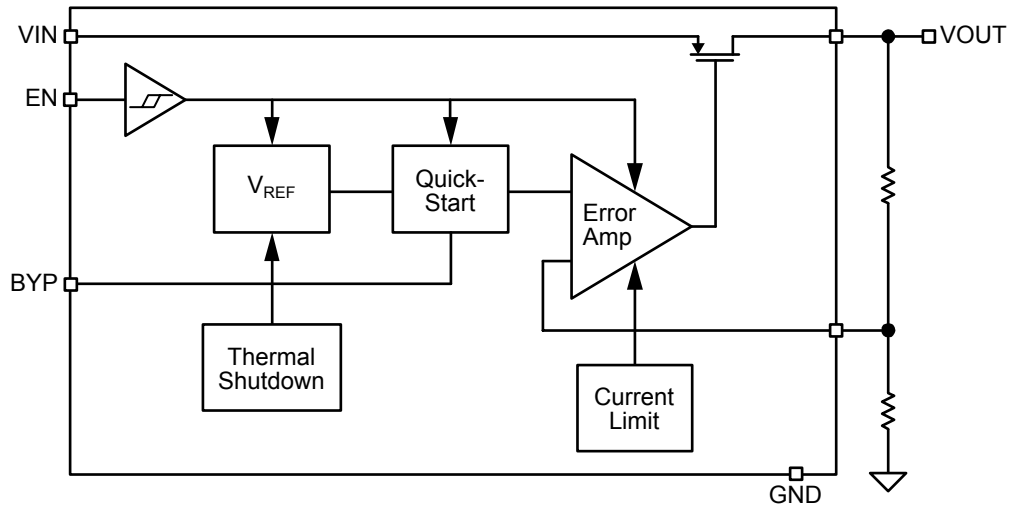

MIC5305 Block Diagram – Adjustable

Application Information

Enable/Shutdown

The MIC5305 comes with an active-high enable pin that allows the regulator to be disabled. Forcing the enable pin low disables the regulator and sends it into a “zero” off-mode-current state. In this state, current consumed by the regulator goes nearly to zero. Forcing the enable pin high enables the output voltage. The active-high enable pin uses CMOS technology and the enable pin cannot be left floating; a floating enable pin may cause an indeterminate state on the output.

Input Capacitor

The MIC5305 is a high-performance, high bandwidth device. Therefore, it requires a well-bypassed input supply for optimal performance. A 1 μ F capacitor is required from the input to ground to provide stability. Low-ESR ceramic capacitors provide optimal performance at a minimum of space. Additional high frequency capacitors, such as small-valued NPO dielectric-type capacitors, help filter out high-frequency noise and are good practice in any RF-based circuit.

Output Capacitor

The MIC5305 requires an output capacitor of 1 μ F or greater to maintain stability. The design is optimized for use with low-ESR ceramic chip capacitors. High ESR capacitors may cause high frequency oscillation. The output capacitor can be increased, but performance has been optimized for a 1 μ F ceramic output capacitor and does not improve significantly with larger capacitance.

X7R/X5R dielectric-type ceramic capacitors are recommended because of their temperature performance. X7R-type capacitors change capacitance by 15% over their operating temperature range and are the most stable type of ceramic capacitors. Z5U and Y5V dielectric capacitors change value by as much as 50% and 60%, respectively, over their operating temperature ranges. To use a ceramic chip capacitor with Y5V dielectric, the value must be much higher than an X7R ceramic capacitor to ensure the same minimum capacitance over the equivalent operating temperature range.

Bypass Capacitor

A capacitor can be placed from the noise bypass pin to ground to reduce output voltage noise. The capacitor bypasses the internal reference. A 0.1 μ F capacitor is recommended for applications that require low-noise outputs. The bypass capacitor can be increased, further reducing noise and improving PSRR. Turn-on time increases slightly with respect to bypass capacitance. A unique, quick-start circuit allows the MIC5305 to drive a large capacitor on the bypass pin without significantly slowing turn-on time. Refer to the Typical Characteristics section for performance with different bypass capacitors.

No-Load Stability

Unlike many other voltage regulators, the MIC5305 will remain stable and in regulation with no load. This is especially important in CMOS RAM keep-alive applications.

Adjustable Regulator Application

Adjustable regulators use the ratio of two resistors to multiply the reference voltage to produce the desired output voltage. The MIC5305 can be adjusted from 1.25V to 5.5V by using two external resistors (Figure 1). The resistors set the output voltage based on the following equation:

$$V_{OUT} = V_{REF} \left(1 + \frac{R1}{R2} \right)$$

$$V_{REF} = 1.25V$$



Figure 1. Adjustable Voltage Application

Thermal Considerations

The MIC5305 is designed to provide 150mA of continuous current in a very small package. Maximum ambient operating temperature can be calculated based on the output current and the voltage drop across the part. Given that the input voltage is 5.0V, the output voltage is 2.9V and the output current = 150mA.

The actual power dissipation of the regulator circuit can be determined using the equation:

$$P_D = (V_{IN} - V_{OUT}) I_{OUT} + V_{IN} I_{GND}$$

Because this device is CMOS and the ground current is typically <100 μ A over the load range, the power dissipation contributed by the ground current is < 1% and can be ignored for this calculation.

$$P_D = (5.0V - 2.9V) \times 150mA \quad P_D = 0.32W$$

To determine the maximum ambient operating temperature of the package, use the junction-to-ambient thermal resistance of the device and the following basic equation:

$$P_{D(max)} = \left(\frac{T_{J(max)} - T_A}{\theta_{JA}} \right)$$

$T_{J(max)} = 125^\circ\text{C}$, the max. junction temperature of the die.

θ_{JA} thermal resistance = 93°C/W

Table 1 shows junction-to-ambient thermal resistance for the MIC5305 in the 6-pin 2mm × 2mm MLF[®] package.

| Package | θ_{JA} Recommended Minimum Footprint | θ_{JC} |
|----------------------------|---------------------------------------------|---------------|
| 6-Pin 2x2 MLF [®] | 93°C/W | 2°C/W |

Table 1. Thermal Resistance

Substituting P_D for $P_{D(max)}$ and solving for the ambient operating temperature will give the maximum operating conditions for the regulator circuit. The junction-to-ambient thermal resistance for the minimum footprint (the minimum amount of copper that you can solder the part to) is 93°C/W, from Table 1. The maximum power dissipation must not be exceeded for proper operation.

For example, when operating the MIC5305-2.9BML at an input voltage of 5.0V and 150mA load with a

minimum footprint layout, the maximum ambient operating temperature T_A can be determined as follows:

$$0.32W = \frac{125^\circ\text{C} - T_A}{93^\circ\text{C/W}}$$

$$T_A = 95.2^\circ\text{C}$$

Therefore, a 2.9V application at 150mA of output current can accept an ambient operating temperature of 95.2°C in a 6-pin 2mm x 2mm MLF[®] package. For a full discussion of heat sinking and thermal effects on voltage regulators, refer to the "Regulator Thermals" section of *Micrel's Designing with Low-Dropout Voltage Regulators* handbook. This information can be found on Micrel's website at:

http://www.micrel.com/_PDF/other/LDOBk_ds.pdf

Package Information



TOP VIEW



BOTTOM VIEW

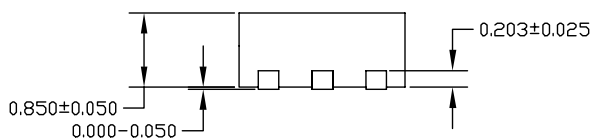

SIDE VIEW

- NOTE:
1. ALL DIMENSIONS ARE IN MILLIMETERS.
 2. MAX. PACKAGE WARPAGE IS 0.05 mm.
 3. MAXIMUM ALLOWABLE BURRS IS 0.076 mm IN ALL DIRECTIONS.
 4. PIN #1 ID ON TOP WILL BE LASER MARKED.

6-Pin 2x2 MLF[®] (ML)



TOP VIEW

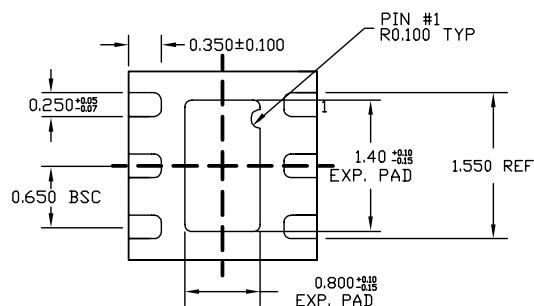

BOTTOM VIEW



SIDE VIEW

- NOTE:
1. ALL DIMENSIONS ARE IN MILLIMETERS.
 2. MAX. PACKAGE WARPAGE IS 0.08 mm.
 3. MAXIMUM ALLOWABLE BURRS IS 0.076 mm IN ALL DIRECTIONS.
 4. PIN #1 ID ON TOP WILL BE LASER MARKED.

6-Pin 2x2 Thin MLF[®] (MT)



NOTE:

1. Dimensions and tolerances are as per ANSI Y14.5M, 1994.
2. Die is facing up for mold. Die is facing down for trim/form, ie. reverse trim/form.
3. Dimensions are exclusive of mold flash and gate burr.
4. The footlength measuring is based on the gauge plane method.
5. All specification comply to Jedec Spec MO193 Issue C.
6. All dimensions are in millimeters.



5-Pin TSOT-23 (D5)

MICREL, INC. 2180 FORTUNE DRIVE SAN JOSE, CA 95131 USA
 TEL +1 (408) 944-0800 FAX +1 (408) 474-1000 WEB <http://www.micrel.com>

The information furnished by Micrel in this data sheet is believed to be accurate and reliable. However, no responsibility is assumed by Micrel for its use. Micrel reserves the right to change circuitry and specifications at any time without notification to the customer.

Micrel Products are not designed or authorized for use as components in life support appliances, devices or systems where malfunction of a product can reasonably be expected to result in personal injury. Life support devices or systems are devices or systems that (a) are intended for surgical implant into the body or (b) support or sustain life, and whose failure to perform can be reasonably expected to result in a significant injury to the user. A Purchaser's use or sale of Micrel Products for use in life support appliances, devices or systems is a Purchaser's own risk and Purchaser agrees to fully indemnify Micrel for any damages resulting from such use or sale.

© 2004 Micrel, Incorporated.

Looking for pricing, stock, or lifecycle information?

Click below to explore more details on WIN SOURCE:

 [View MIC5305-1.8BD5 on WIN SOURCE](#)

 [Microchip Technology](#) Information

Optimize Your Supply Chain with WIN SOURCE Solutions

-  Global Sourcing Solution
-  Obsolete Management
-  Cost Control Management
-  Shortage Management
-  Alternative Solution
-  Excess Inventory Management