



**THE DATASHEET OF  
IRFR3710ZPBF**



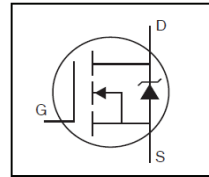
HEXFET® Power MOSFET

**Features**

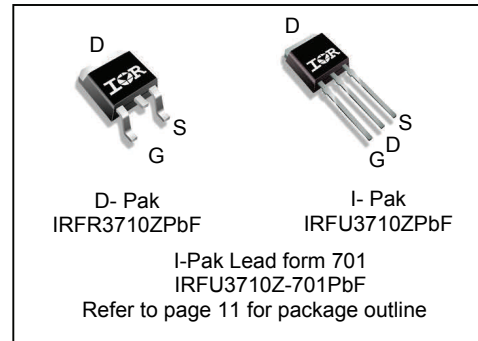
- Advanced Process Technology
- Ultra Low On-Resistance
- 175°C Operating Temperature
- Fast Switching
- Repetitive Avalanche Allowed up to  $T_{jmax}$
- Multiple Package Options
- Lead-Free

**Description**

This HEXFET® Power MOSFET utilizes the latest processing techniques to achieve extremely low on-resistance per silicon area. Additional features of this design are a 175°C junction operating temperature, fast switching speed and improved repetitive avalanche rating. These features combine to make this design an extremely efficient and reliable device for use in a wide variety of applications.



$V_{DSS}$	<b>100V</b>
$R_{DS(on)}$	<b>18mΩ</b>
$I_D$	<b>42A</b>



<b>G</b>	<b>D</b>	<b>S</b>
Gate	Drain	Source

Base part number	Package Type	Standard Pack		Orderable Part Number
		Form	Quantity	
IRFU3710ZPbF	I-Pak	Tube	75	IRFU3710ZPbF
IRFR3710ZPbF	D-Pak	Tube	75	IRFR3710ZPbF
		Tape and Reel Left	3000	IRFR3710ZTRLpbF

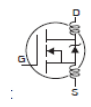
**Absolute Maximum Ratings**

Symbol	Parameter	Max.	Units
$I_D @ T_C = 25^\circ C$	Continuous Drain Current, $V_{GS} @ 10V$ (Silicon Limited)	56	A
$I_D @ T_C = 100^\circ C$	Continuous Drain Current, $V_{GS} @ 10V$	39	
$I_D @ T_C = 25^\circ C$	Continuous Drain Current, $V_{GS} @ 10V$ (Package Limited)	42	
$I_{DM}$	Pulsed Drain Current ①	220	
$P_D @ T_C = 25^\circ C$	Maximum Power Dissipation	140	W
	Linear Derating Factor	0.95	W/°C
$V_{GS}$	Gate-to-Source Voltage	± 20	V
$E_{AS}$ (Thermally limited)	Single Pulse Avalanche Energy ②	150	mJ
$E_{AS}$ (Tested)	Single Pulse Avalanche Energy Tested Value ⑥	200	
$I_{AR}$	Avalanche Current ①	See Fig.12a, 12b, 15, 16	A
$E_{AR}$	Repetitive Avalanche Energy ⑤		mJ
$T_J$ $T_{STG}$	Operating Junction and Storage Temperature Range	-55 to + 175	°C
	Soldering Temperature, for 10 seconds (1.6mm from case)	300	

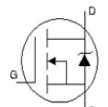
**Thermal Resistance**

Symbol	Parameter	Typ.	Max.	Units
$R_{\theta JC}$	Junction-to-Case	—	1.05	°C/W
$R_{\theta JA}$	Junction-to-Ambient ( PCB Mount ) ⑦	—	50	
$R_{\theta JA}$	Junction-to-Ambient	—	110	

**Electrical Characteristics @ T<sub>J</sub> = 25°C (unless otherwise specified)**

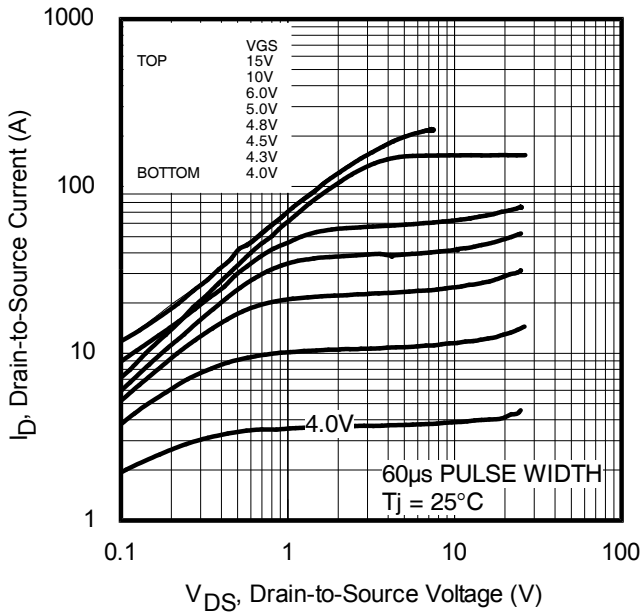
	Parameter	Min.	Typ.	Max.	Units	Conditions
V <sub>(BR)DSS</sub>	Drain-to-Source Breakdown Voltage	100	—	—	V	V <sub>GS</sub> = 0V, I <sub>D</sub> = 250μA
ΔV <sub>(BR)DSS</sub> /ΔT <sub>J</sub>	Breakdown Voltage Temp. Coefficient	—	0.088	—	V/°C	Reference to 25°C, I <sub>D</sub> = 1mA
R <sub>DS(on)</sub>	Static Drain-to-Source On-Resistance	—	15	18	mΩ	V <sub>GS</sub> = 10V, I <sub>D</sub> = 33A ③
V <sub>GS(th)</sub>	Gate Threshold Voltage	2.0	—	4.0	V	V <sub>DS</sub> = V <sub>GS</sub> , I <sub>D</sub> = 250μA
g <sub>fs</sub>	Forward Trans conductance	39	—	—	S	V <sub>DS</sub> = 25V, I <sub>D</sub> = 33A
I <sub>DSS</sub>	Drain-to-Source Leakage Current	—	—	20	μA	V <sub>DS</sub> = 100V, V <sub>GS</sub> = 0V
		—	—	250		V <sub>DS</sub> = 100V, V <sub>GS</sub> = 0V, T <sub>J</sub> = 125°C
I <sub>GSS</sub>	Gate-to-Source Forward Leakage	—	—	200	nA	V <sub>GS</sub> = 20V
	Gate-to-Source Reverse Leakage	—	—	-200		V <sub>GS</sub> = -20V
Q <sub>g</sub>	Total Gate Charge	—	69	100	nC	I <sub>D</sub> = 33A
Q <sub>gs</sub>	Gate-to-Source Charge	—	15	—		V <sub>DS</sub> = 80V
Q <sub>gd</sub>	Gate-to-Drain ('Miller') Charge	—	25	—		V <sub>GS</sub> = 10V ③
t <sub>d(on)</sub>	Turn-On Delay Time	—	14	—	ns	V <sub>DD</sub> = 50V
t <sub>r</sub>	Rise Time	—	43	—		I <sub>D</sub> = 33A
t <sub>d(off)</sub>	Turn-Off Delay Time	—	53	—		R <sub>G</sub> = 6.8Ω
t <sub>f</sub>	Fall Time	—	42	—		V <sub>GS</sub> = 10V ③
L <sub>D</sub>	Internal Drain Inductance	—	4.5	—	nH	Between lead, 6mm (0.25in.) from package and center of die contact 
L <sub>S</sub>	Internal Source Inductance	—	7.5	—		
C <sub>iss</sub>	Input Capacitance	—	2930	—	pF	V <sub>GS</sub> = 0V
C <sub>oss</sub>	Output Capacitance	—	290	—		V <sub>DS</sub> = 25V
C <sub>rss</sub>	Reverse Transfer Capacitance	—	180	—		f = 1.0MHz
C <sub>oss</sub>	Output Capacitance	—	1200	—		V <sub>GS</sub> = 0V, V <sub>DS</sub> = 1.0V, f = 1.0MHz
C <sub>oss</sub>	Output Capacitance	—	180	—		V <sub>GS</sub> = 0V, V <sub>DS</sub> = 80V, f = 1.0MHz
C <sub>oss eff.</sub>	Effective Output Capacitance	—	430	—		V <sub>GS</sub> = 0V, V <sub>DS</sub> = 0V to 80V

**Source-Drain Ratings and Characteristics**

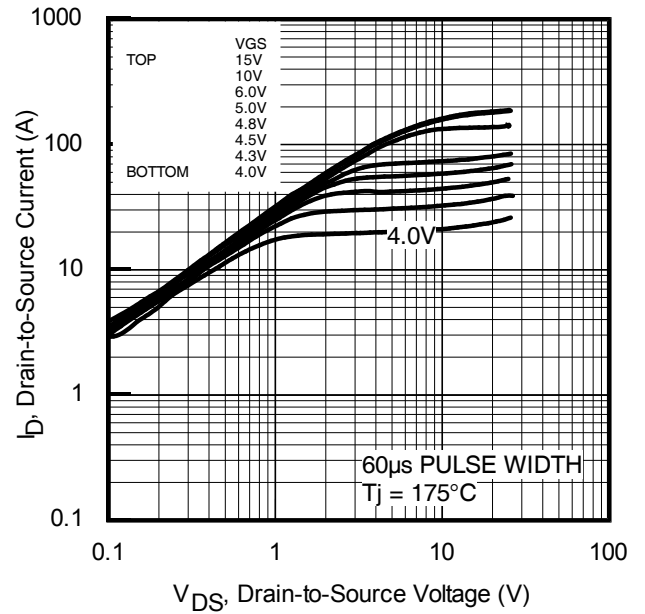
	Parameter	Min.	Typ.	Max.	Units	Conditions
I <sub>S</sub>	Continuous Source Current (Body Diode)	—	—	56	A	MOSFET symbol showing the integral reverse p-n junction diode. 
I <sub>SM</sub>	Pulsed Source Current (Body Diode) ①	—	—	220		
V <sub>SD</sub>	Diode Forward Voltage	—	—	1.3	V	T <sub>J</sub> = 25°C, I <sub>S</sub> = 33A, V <sub>GS</sub> = 0V ③
t <sub>rr</sub>	Reverse Recovery Time	—	35	53	ns	T <sub>J</sub> = 25°C, I <sub>F</sub> = 33A, V <sub>DS</sub> = 50V
Q <sub>rr</sub>	Reverse Recovery Charge	—	41	62	nC	di/dt = 100A/μs ③
t <sub>on</sub>	Forward Turn-On Time	Intrinsic turn-on time is negligible (turn-on is dominated by L <sub>S</sub> +L <sub>D</sub> )				

**Notes:**

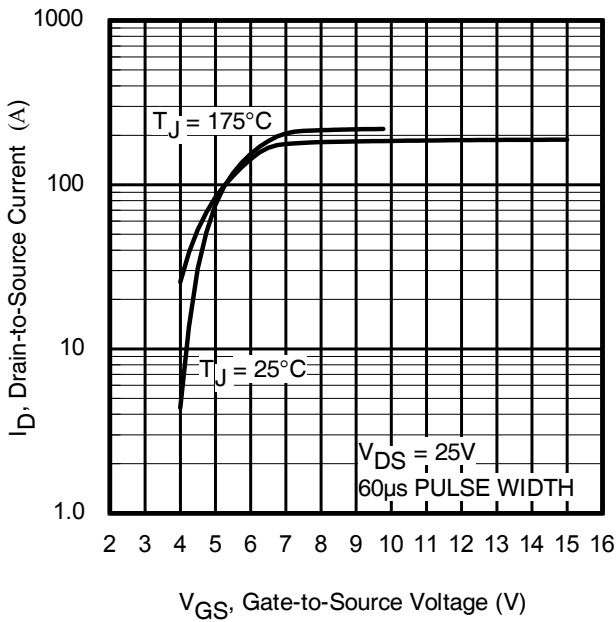
- ① Repetitive rating; pulse width limited by max. junction temperature. (See fig. 11).
- ② starting T<sub>J</sub> = 25°C, L = 0.28mH, R<sub>G</sub> = 25Ω, I<sub>AS</sub> = 33A, V<sub>GS</sub> = 10V. Part not recommended for use above this value.
- ③ Pulse width ≤ 1.0ms; duty cycle ≤ 2%.
- ④ C<sub>oss eff.</sub> is a fixed capacitance that gives the same charging time as C<sub>oss</sub> while V<sub>DS</sub> is rising from 0 to 80% V<sub>DSS</sub>
- ⑤ Limited by T<sub>Jmax</sub>, see Fig.12a, 12b, 15, 16 for typical repetitive avalanche performance.
- ⑥ This value determined from sample failure population. 100% tested to this value in production.
- ⑦ When mounted on 1" square PCB (FR-4 or G-10 Material). For recommended footprint and soldering techniques refer to application note #AN-994.
- ⑧ Refer to D-Pak package for Part Marking, Tape and Reel information



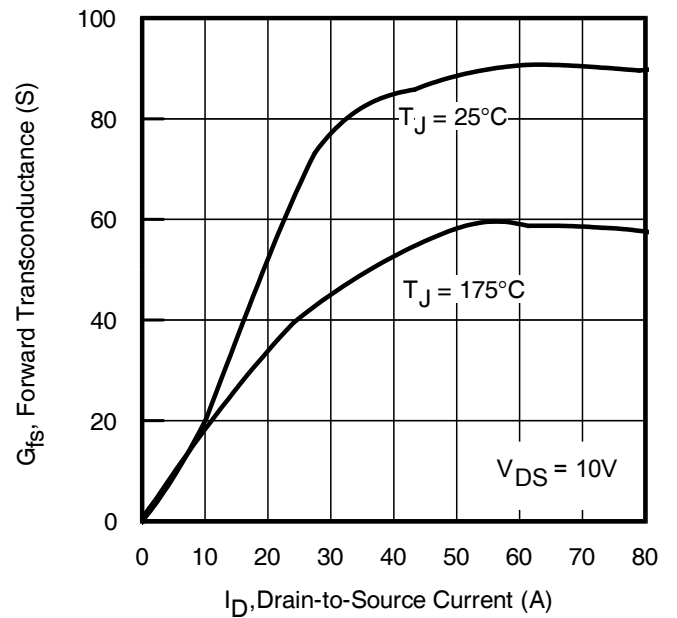
**Fig. 1 Typical Output Characteristics**



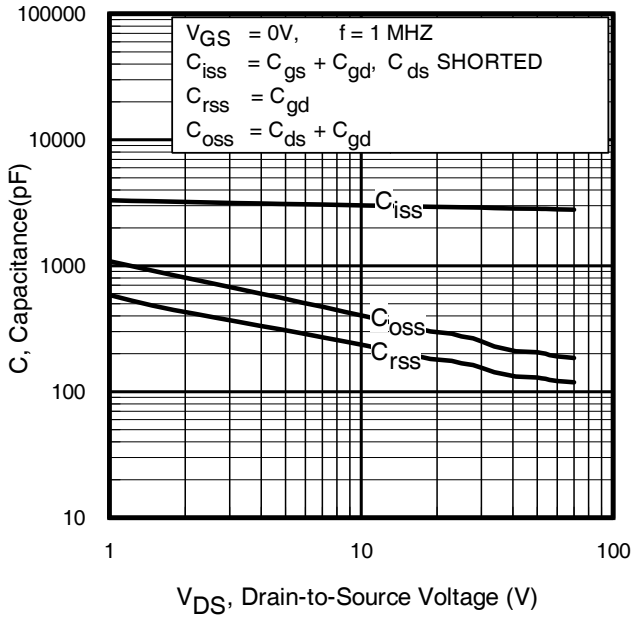
**Fig. 2 Typical Output Characteristics**



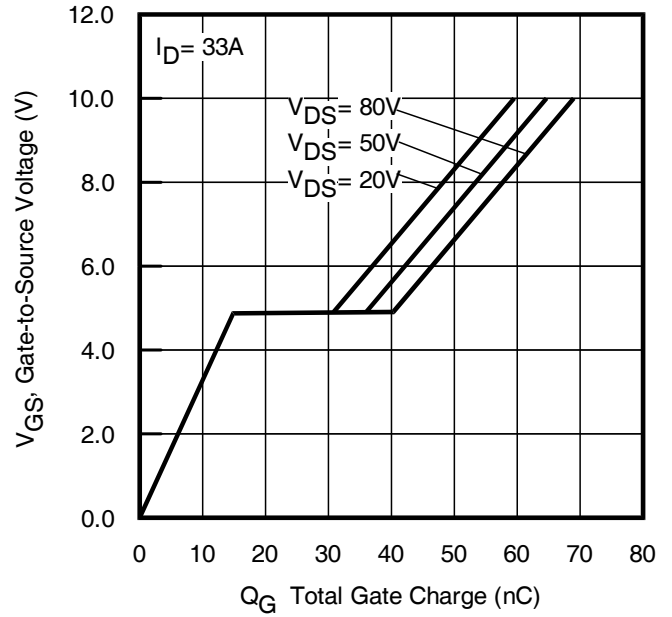
**Fig. 3 Typical Transfer Characteristics**



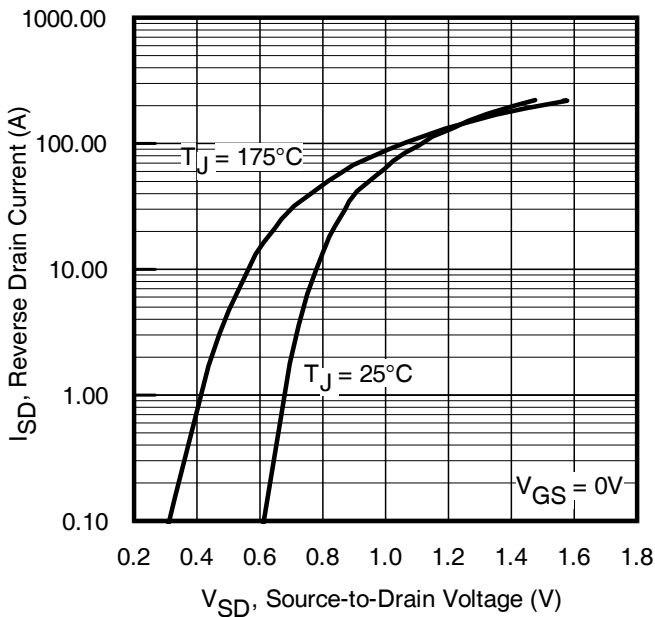
**Fig. 4 Typical Forward Transconductance vs. Drain Current**



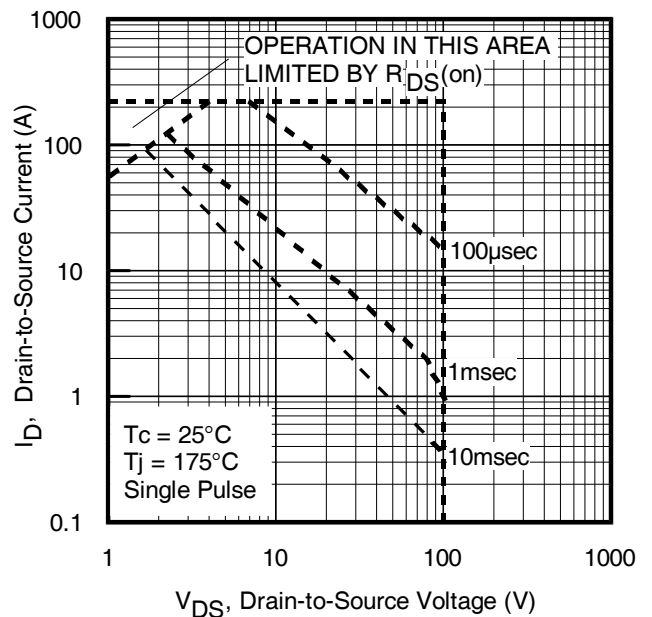
**Fig 5.** Typical Capacitance vs. Drain-to-Source Voltage



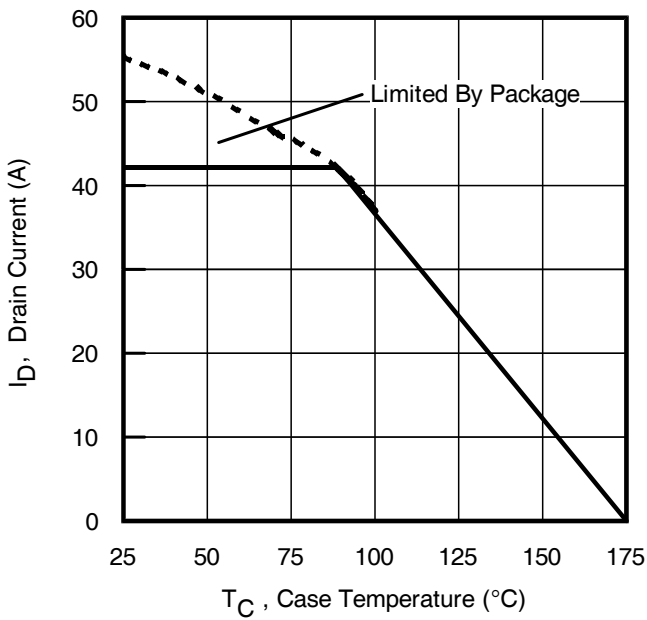
**Fig 6.** Typical Gate Charge vs. Gate-to-Source Voltage



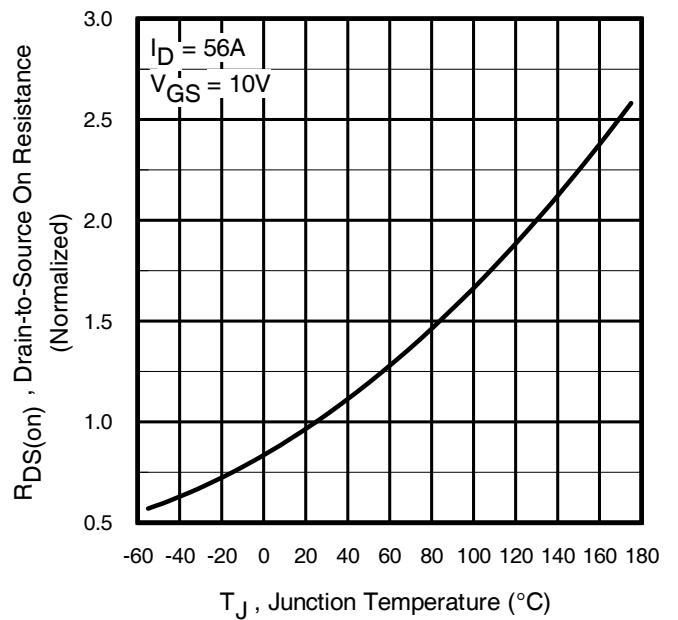
**Fig 7.** Typical Source-to-Drain Diode Forward Voltage



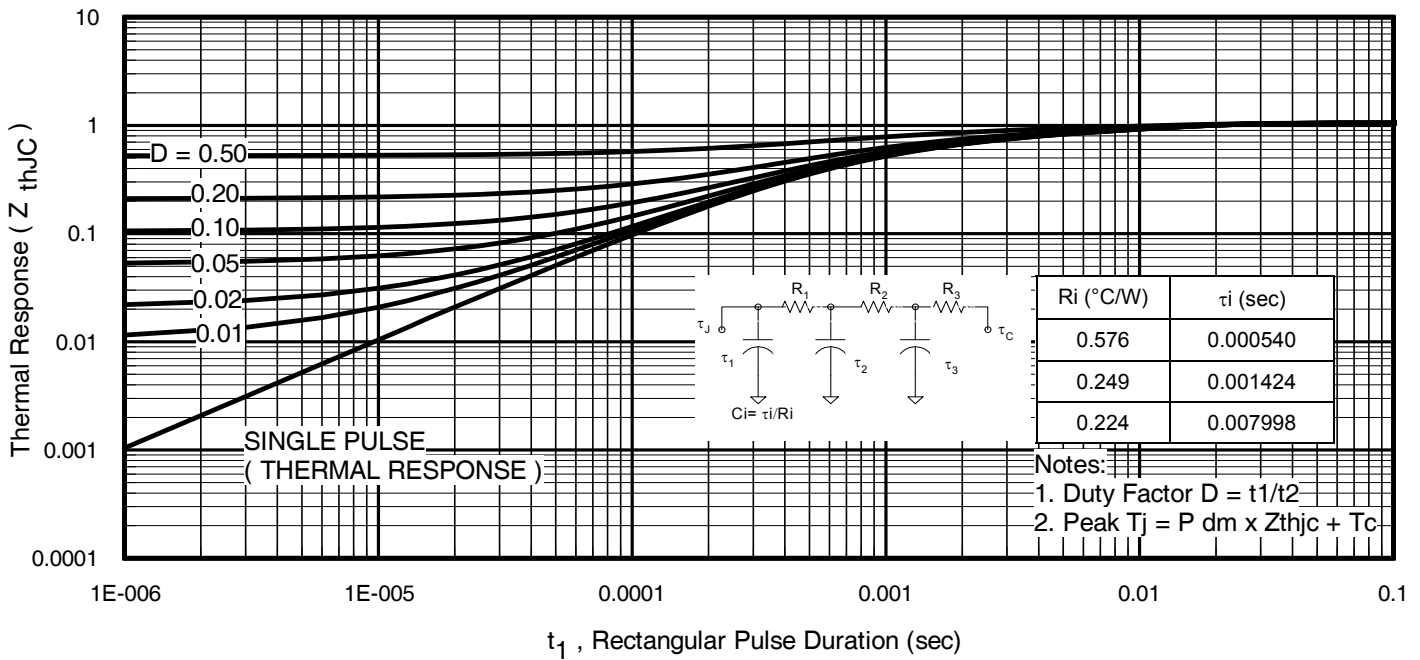
**Fig 8.** Maximum Safe Operating Area



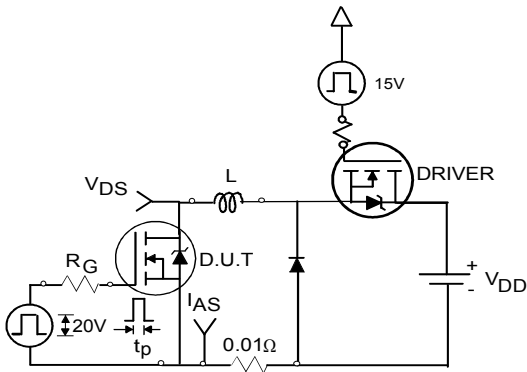
**Fig 9.** Maximum Drain Current vs. Case Temperature



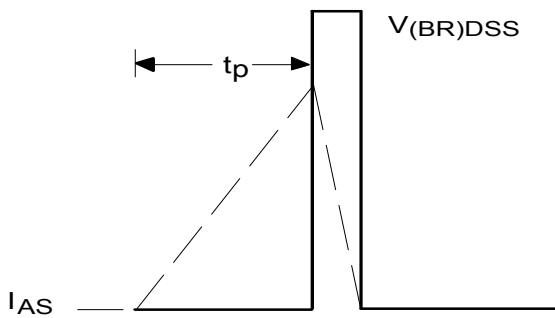
**Fig 10.** Normalized On-Resistance vs. Temperature



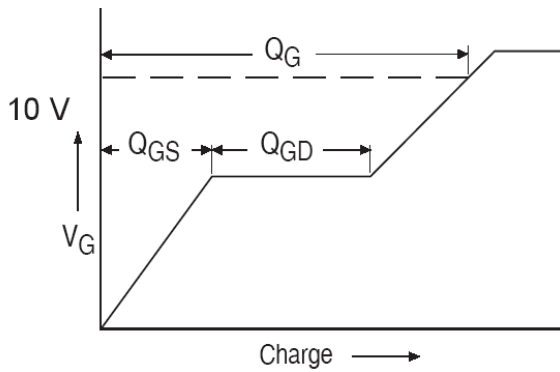
**Fig 11.** Maximum Effective Transient Thermal Impedance, Junction-to-Case



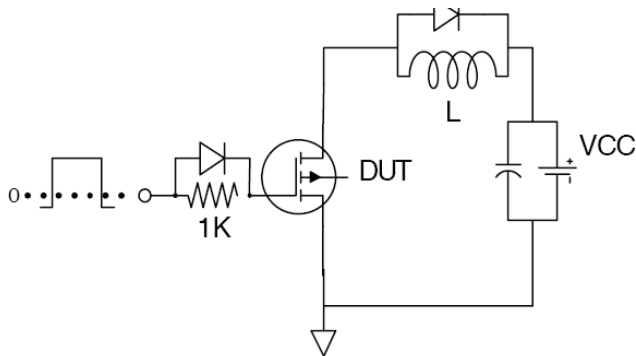
**Fig 12a.** Unclamped Inductive Test Circuit



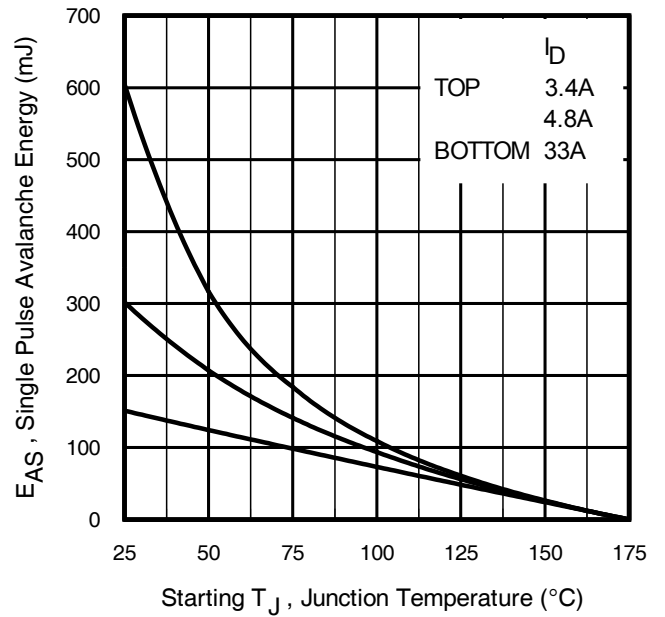
**Fig 12b.** Unclamped Inductive Waveforms



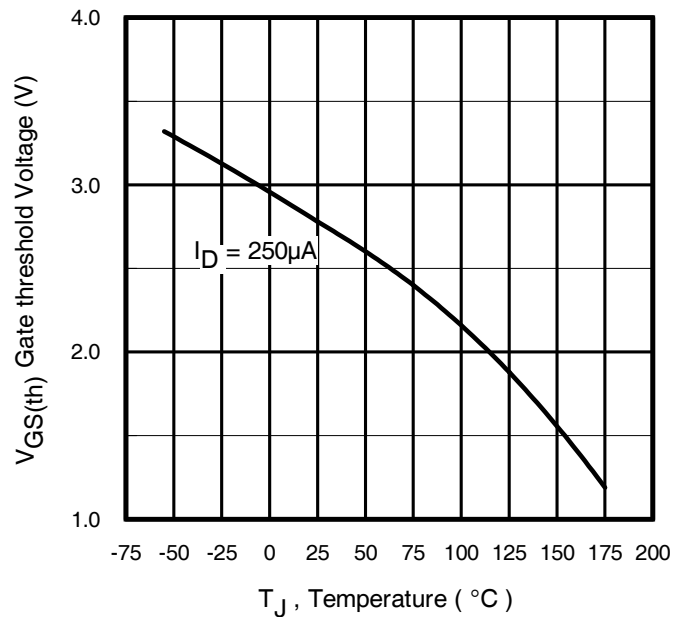
**Fig 13a.** Gate Charge Waveform



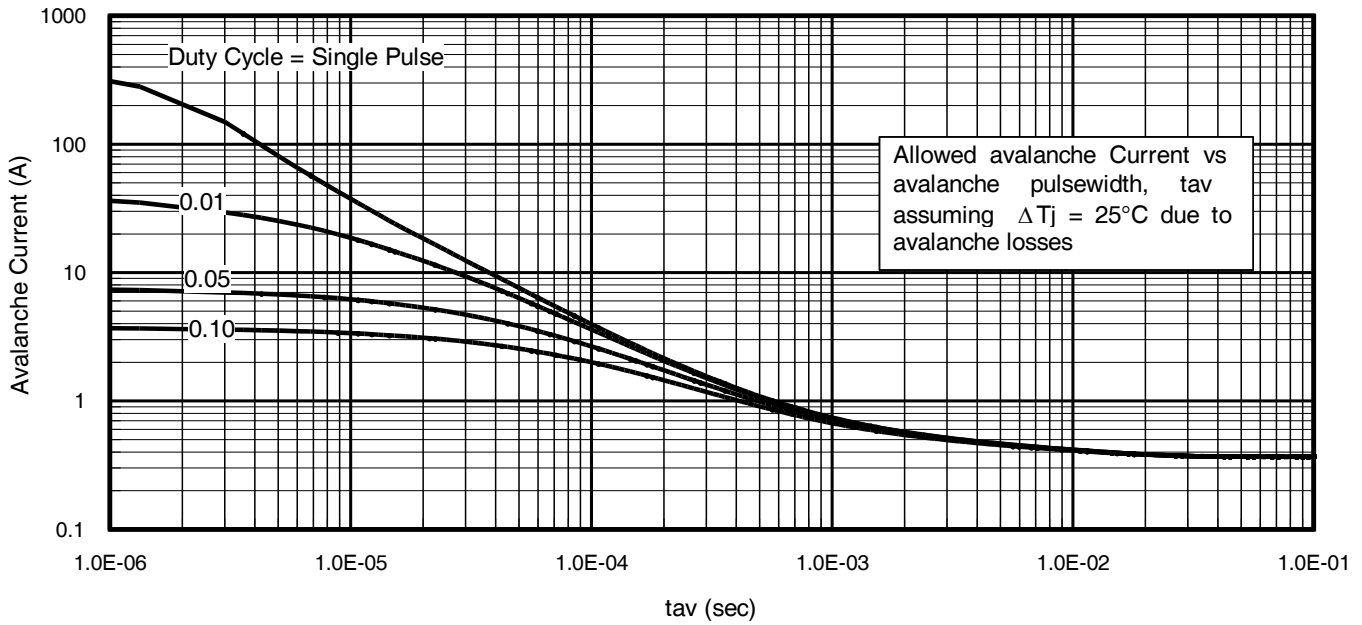
**Fig 13b.** Gate Charge Test Circuit



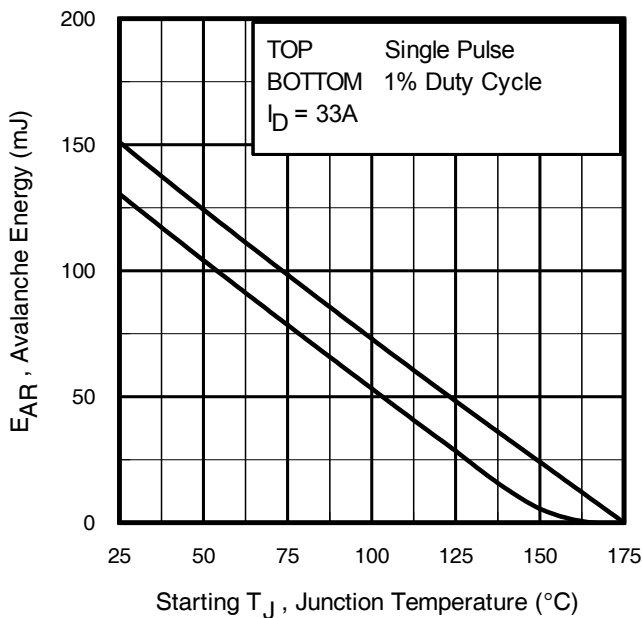
**Fig 12c.** Maximum Avalanche Energy vs. Drain Current



**Fig 14.** Threshold Voltage vs. Temperature



**Fig 15.** Typical Avalanche Current vs. Pulse width



**Fig 16.** Maximum Avalanche Energy vs. Temperature

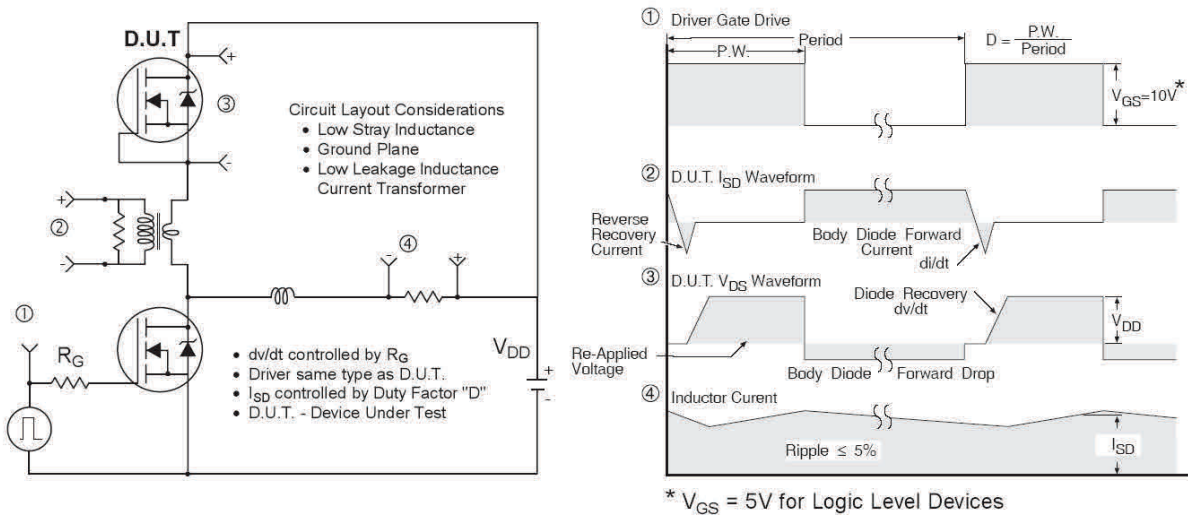
**Notes on Repetitive Avalanche Curves , Figures 15, 16: (For further info, see AN-1005 at www.infineon.com)**

1. Avalanche failures assumption:  
Purely a thermal phenomenon and failure occurs at a temperature far in excess of  $T_{jmax}$ . This is validated for every part type.
2. Safe operation in Avalanche is allowed as long as  $T_{jmax}$  is not exceeded.
3. Equation below based on circuit and waveforms shown in Figures 12a, 12b.
4.  $P_{D(ave)}$  = Average power dissipation per single avalanche pulse.
5. BV = Rated breakdown voltage (1.3 factor accounts for voltage increase during avalanche).
6.  $I_{av}$  = Allowable avalanche current.
7.  $\Delta T$  = Allowable rise in junction temperature, not to exceed  $T_{jmax}$  (assumed as 25°C in Figure 15, 16).  
 $t_{av}$  = Average time in avalanche.  
 $D$  = Duty cycle in avalanche =  $t_{av} \cdot f$   
 $Z_{thJC}(D, t_{av})$  = Transient thermal resistance, see figure 11)

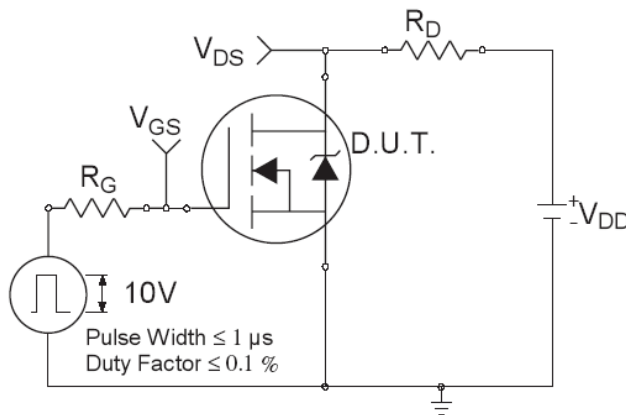
$$P_{D(ave)} = 1/2 ( 1.3 \cdot BV \cdot I_{av} ) = \Delta T / Z_{thJC}$$

$$I_{av} = 2\Delta T / [1.3 \cdot BV \cdot Z_{th}]$$

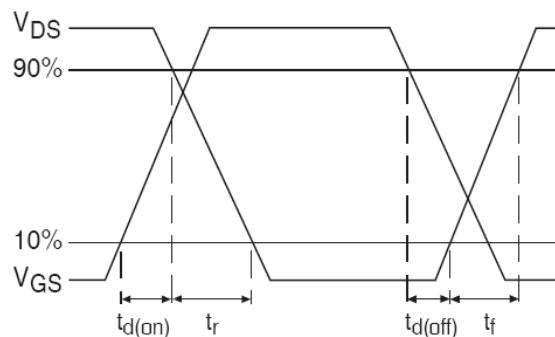
$$E_{AS(AR)} = P_{D(ave)} \cdot t_{av}$$



**Fig 17.** Peak Diode Recovery  $dv/dt$  Test Circuit for N-Channel HEXFET® Power MOSFETs

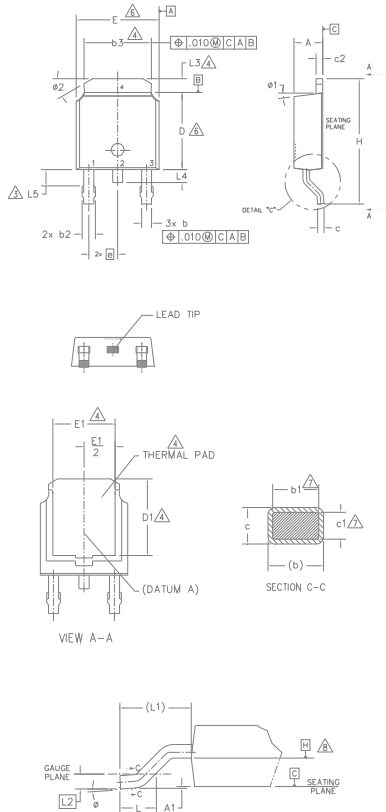


**Fig 18a.** Switching Time Test Circuit



**Fig 18b.** Switching Time Waveforms

## D-Pak (TO-252AA) Package Outline (Dimensions are shown in millimeters (inches))



**NOTES:**

- 1.- DIMENSIONING AND TOLERANCING PER ASME Y14.5M-1994
- 2.- DIMENSION ARE SHOWN IN INCHES [MILLIMETERS]
- 3.- LEAD DIMENSION UNCONTROLLED IN L5.
- 4.- DIMENSION D1, E1, L3 & b3 ESTABLISH A MINIMUM MOUNTING SURFACE FOR THERMAL PAD.
- 5.- SECTION C-C DIMENSIONS APPLY TO THE FLAT SECTION OF THE LEAD BETWEEN .005 AND 0.10 [0.13 AND 0.25] FROM THE LEAD TIP.
- 6.- DIMENSION D & E DO NOT INCLUDE MOLD FLASH. MOLD FLASH SHALL NOT EXCEED .006 [0.15] PER SIDE. THESE DIMENSIONS ARE MEASURED AT THE OUTMOST EXTREMES OF THE PLASTIC BODY.
- 7.- DIMENSION b1 & c1 APPLIED TO BASE METAL ONLY.
- 8.- DATUM A & B TO BE DETERMINED AT DATUM PLANE H.
- 9.- OUTLINE CONFORMS TO JEDEC OUTLINE TO-252AA.

SYMBOL	DIMENSIONS				NOTES
	MILLIMETERS		INCHES		
	MIN.	MAX.	MIN.	MAX.	
A	2.18	2.39	.086	.094	
A1	-	0.13	-	.005	
b	0.64	0.89	.025	.035	
b1	0.64	0.79	.025	.031	7
b2	0.76	1.14	.030	.045	
b3	4.95	5.46	.195	.215	4
c	0.46	0.61	.018	.024	
c1	0.41	0.56	.016	.022	7
c2	0.46	0.89	.018	.035	
D	5.97	6.22	.235	.245	6
D1	5.21	-	.205	-	4
E	6.35	6.73	.250	.265	6
E1	4.32	-	.170	-	4
e	2.29 BSC		.090 BSC		
H	9.40	10.41	.370	.410	
L	1.40	1.78	.055	.070	
L1	2.74 BSC		.108 REF.		
L2	0.51 BSC		.020 BSC		
L3	0.89	1.27	.035	.050	4
L4	-	1.02	-	.040	
L5	1.14	1.52	.045	.060	3
ø	0°	10°	0°	10°	
ø1	0°	15°	0°	15°	
ø2	25°	35°	25°	35°	

**LEAD ASSIGNMENTS**

**HEXFET**

- 1.- GATE
- 2.- DRAIN
- 3.- SOURCE
- 4.- DRAIN

**IGBT & CoPAK**

- 1.- GATE
- 2.- COLLECTOR
- 3.- EMITTER
- 4.- COLLECTOR

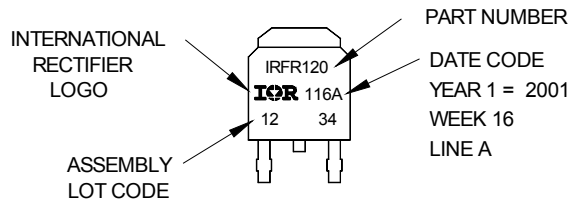
## D-Pak (TO-252AA) Part Marking Information

EXAMPLE: THIS IS AN IRFR120 WITH ASSEMBLY LOT CODE 1234 ASSEMBLED ON VV 16, 2001 IN THE ASSEMBLY LINE "A"

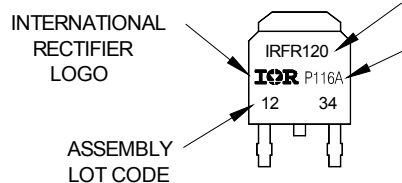
Note: "P" in assembly line position indicates "Lead-Free"

"P̄" in assembly line position indicates "Lead-Free" qualification to the consumer-level

OR



PART NUMBER  
DATE CODE  
YEAR 1 = 2001  
WEEK 16  
LINE A

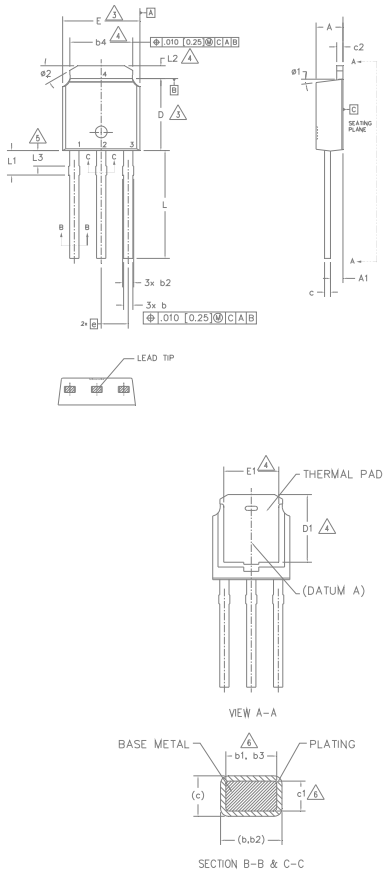


PART NUMBER  
DATE CODE  
P = DESIGNATES LEAD-FREE PRODUCT (OPTIONAL)  
P̄ = DESIGNATES LEAD-FREE PRODUCT QUALIFIED TO THE CONSUMER LEVEL (OPTIONAL)  
YEAR 1 = 2001  
WEEK 16  
A = ASSEMBLY SITE CODE

**Notes:**

1. For an Automotive Qualified version of this part please see <http://www.infineon.com/product-info/datasheets/data/aurfr3710z.pdf>
2. For the most current drawing please refer to Infineon website at <http://www.infineon.com/package/>

## I-Pak (TO-251AA) Package Outline Dimensions are shown in millimeters (inches)



- NOTES:
- 1.- DIMENSIONING AND TOLERANCING PER ASME Y14.5M-1994
  - 2.- DIMENSION ARE SHOWN IN INCHES [MILLIMETERS].
  3. DIMENSION D & E DO NOT INCLUDE MOLD FLASH. MOLD FLASH SHALL NOT EXCEED .005 [0.13] PER SIDE. THESE DIMENSIONS ARE MEASURED AT THE OUTMOST EXTREMES OF THE PLASTIC BODY.
  4. THERMAL PAD CONTOUR OPTION WITHIN DIMENSION b4, L2, E1 & D1.
  5. LEAD DIMENSION UNCONTROLLED IN L3.
  6. DIMENSION b1, b3 & c1 APPLY TO BASE METAL ONLY.
  - 7.- OUTLINE CONFORMS TO JEDEC OUTLINE TO-251AA (Date 06/02).
  - 8.- CONTROLLING DIMENSION : INCHES.

SYMBOL	DIMENSIONS				NOTES
	MILLIMETERS		INCHES		
	MIN.	MAX.	MIN.	MAX.	
A	2.18	2.39	.086	.094	
A1	0.89	1.14	.035	.045	
b	0.64	0.89	.025	.035	
b1	0.65	0.79	.025	.031	6
b2	0.76	1.14	.030	.045	
b3	0.76	1.04	.030	.041	6
b4	4.95	5.46	.195	.215	4
c	0.46	0.61	.018	.024	
c1	0.41	0.56	.016	.022	6
c2	0.46	0.89	.018	.035	
D	5.97	6.22	.235	.245	3
D1	5.21	-	.205	-	4
E	6.35	6.73	.250	.265	3
E1	4.32	-	.170	-	4
e	2.29 BSC		.090 BSC		
L	8.89	9.65	.350	.380	
L1	1.91	2.29	.045	.090	
L2	0.89	1.27	.035	.050	4
L3	0.89	1.52	.035	.060	5
ø1	0"	15"	0"	15"	
ø2	25"	35"	25"	35"	

### LEAD ASSIGNMENTS

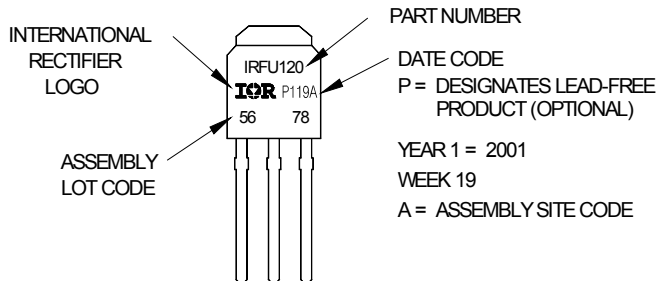
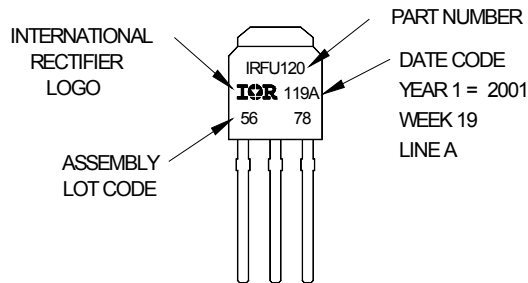
- HEXFET
- 1.- GATE
  - 2.- DRAIN
  - 3.- SOURCE
  - 4.- DRAIN

## I-Pak (TO-251AA) Part Marking Information

EXAMPLE: THIS IS AN IRFU120 WITH ASSEMBLY LOT CODE 5678 ASSEMBLED ON WW 19, 2001 IN THE ASSEMBLY LINE "A"

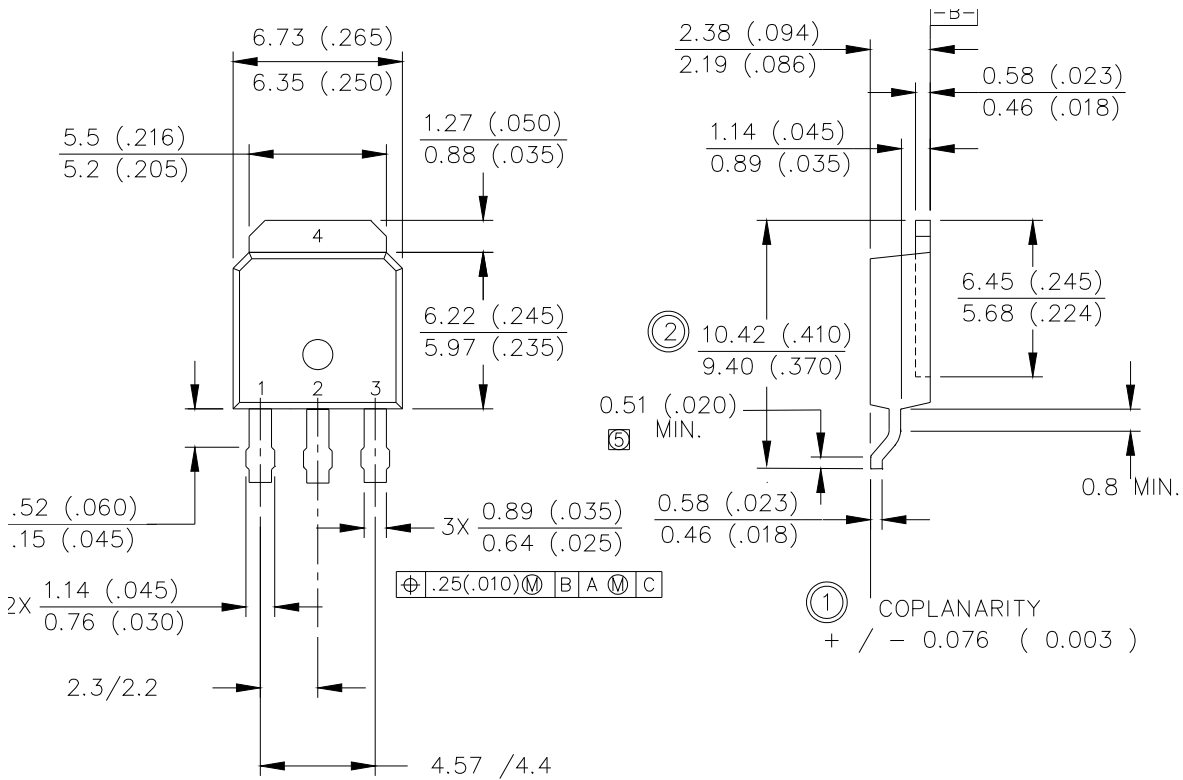
Note: "P" in assembly line position indicates Lead-Free

OR



### Notes:

1. For an Automotive Qualified version of this part please see <http://www.infineon.com/product-info/auto/>
2. For the most current drawing please refer to Infineon website at <http://www.infineon.com/package/>

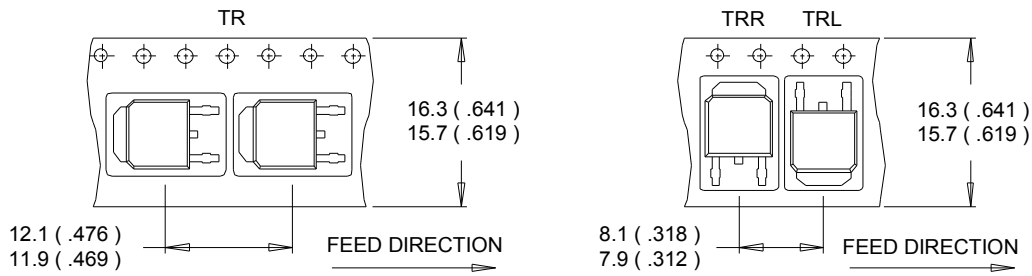
**I-Pak Leadform Option 701 Package Outline ®**  
 Dimensions are shown in millimeters (inches)


- 1-. GATE
- 2-. DRAIN
- 3-. SOURCE
- 4-. DRAIN

**NOTES:**

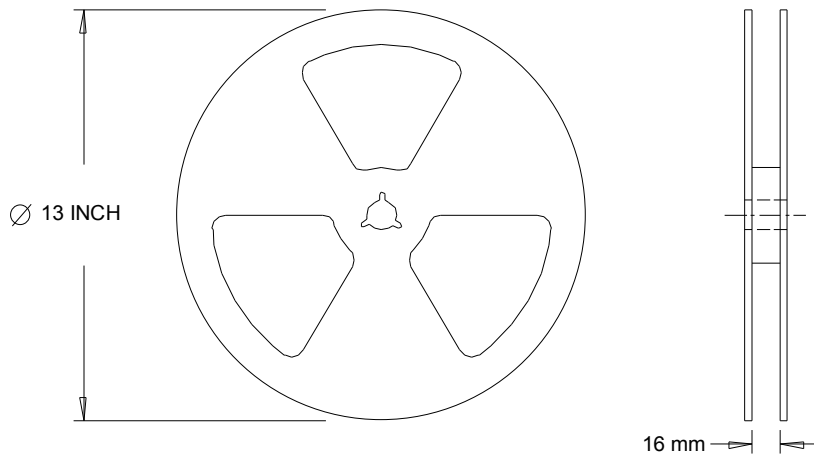
- 1.0 CONTROL DIMENSIONS IN INCHES
- 2.0 PARALLELISM AND ANGULARITY MAX. 0.076 (0.003)
- 3.0 LEADFORM CRITICAL DIMENSIONS DOUBLE RINGED

D-Pak (TO-252AA) Tape & Reel Information Dimensions are shown in millimeters (inches)



NOTES :

1. CONTROLLING DIMENSION : MILLIMETER.
2. ALL DIMENSIONS ARE SHOWN IN MILLIMETERS ( INCHES ).
3. OUTLINE CONFORMS TO EIA-481 & EIA-541.



NOTES :

1. OUTLINE CONFORMS TO EIA-481.

Note: For the most current drawing please refer to Infineon's web site [www.infineon.com](http://www.infineon.com)

## Qualification Information†

Qualification Level	Industrial (per JEDEC JESD47F) ††	
Moisture Sensitivity Level	D-Pak	MSL1 (per JEDEC J-STD-020D) ††
	I-Pak	
RoHS Compliant	Yes	

† Qualification standards can be found at Infineon’s web site [www.infineon.com](http://www.infineon.com)

†† Applicable version of JEDEC standard at the time of product release.

## Revision History

Date	Comments
5/31/2016	<ul style="list-style-type: none"> <li>Updated datasheet with corporate template.</li> <li>Added disclaimer on last page.</li> </ul>

## Trademarks of Infineon Technologies AG

µHVIC™, µIPM™, µPFC™, AU-ConvertIR™, AURIX™, C166™, CanPAK™, CIPOS™, CIPURSE™, CoolDP™, CoolGaN™, COOLiR™, CoolMOS™, CoolSET™, CoolSiC™, DAVE™, DI-POL™, DirectFET™, DrBlade™, EasyPIM™, EconoBRIDGE™, EconoDUAL™, EconoPACK™, EconoPIM™, EiceDRIVER™, eupec™, FCOS™, GaNpowIR™, HEXFET™, HITFET™, HybridPACK™, iMOTION™, IRAM™, ISOFACE™, IsoPACK™, LEDrivIR™, LITIX™, MIPAQ™, ModSTACK™, my-d™, NovalithIC™, OPTIGA™, OptiMOS™, ORIGA™, PowIRaudio™, PowIRstage™, PrimePACK™, PrimeSTACK™, PROFET™, PRO-SiL™, RASIC™, REAL3™, SmartLEWIS™, SOLID FLASH™, SPOC™, StrongIRFET™, SupIRBuck™, TEMPFET™, TRENCHSTOP™, TriCore™, UHVIC™, XHP™, XMC™

Trademarks updated November 2015

## Other Trademarks

All referenced product or service names and trademarks are the property of their respective owners.

**Edition 2016-04-19**

**Published by**

**Infineon Technologies AG**

**81726 Munich, Germany**

**© 2016 Infineon Technologies AG.**

**All Rights Reserved.**

**Do you have a question about this document?**

**Email:** [erratum@infineon.com](mailto:erratum@infineon.com)

**Document reference**

**ifx1**

### IMPORTANT NOTICE

The information given in this document shall in no event be regarded as a guarantee of conditions or characteristics (“**Beschaffensgarantie**”).

With respect to any examples, hints or any typical values stated herein and/or any information regarding the application of the product, Infineon Technologies hereby disclaims any and all warranties and liabilities of any kind, including without limitation warranties of non-infringement of intellectual property rights of any third party.

In addition, any information given in this document is **subject to customer’s compliance with its obligations** stated in this document and any applicable legal requirements, norms and standards concerning customer’s products and any use of the product of Infineon Technologies in **customer’s applications**.

The data contained in this document is exclusively intended for technically trained staff. It is the **responsibility of customer’s technical departments** to evaluate the suitability of the product for the intended application and the completeness of the product information given in this document with respect to such application.

For further information on the product, technology, delivery terms and conditions and prices please contact your nearest Infineon Technologies office ([www.infineon.com](http://www.infineon.com)).

Please note that this product is not qualified according to the AEC Q100 or AEC Q101 documents of the Automotive Electronics Council.

### WARNINGS

Due to technical requirements products may contain dangerous substances. For information on the types in question please contact your nearest Infineon Technologies office.

Except as otherwise explicitly approved by Infineon Technologies in a written document signed by authorized representatives of Infineon Technologies, **Infineon Technologies’ products may not be used** in any applications where a failure of the product or any consequences of the use thereof can reasonably be expected to result in personal injury.

## Looking for pricing, stock, or lifecycle information?

Click below to explore more details on WIN SOURCE:

 [View IRFR3710ZPBF on WIN SOURCE](#)

 [Infineon Technologies](#) Information

## Optimize Your Supply Chain with WIN SOURCE Solutions

-  Global Sourcing Solution
-  Obsolete Management
-  Cost Control Management
-  Shortage Management
-  Alternative Solution
-  Excess Inventory Management