



**THE DATASHEET OF  
IXTH44P15T**



# TrenchP™ Power MOSFETs

P-Channel Enhancement Mode  
Avalanche Rated

**IXTA44P15T**  
**IXTP44P15T**  
**IXTQ44P15T**  
**IXTH44P15T**

$V_{DSS} = -150V$   
 $I_{D25} = -44A$   
 $R_{DS(on)} \leq 65m\Omega$

TO-263 AA (IXTA)

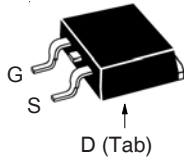

TO-220AB (IXTP)

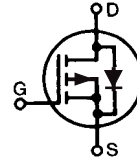
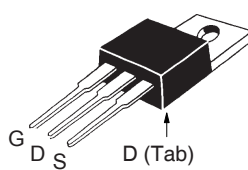

TO-3P (IXTQ)

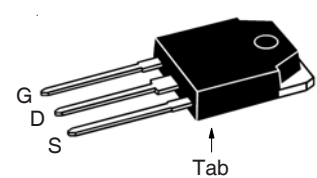

TO-247 (IXTH)

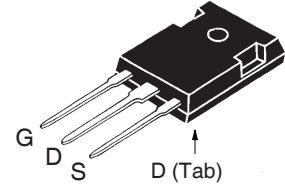

G = Gate      D = Drain  
S = Source    Tab = Drain

Symbol	Test Conditions	Maximum Ratings	
$V_{DSS}$	$T_J = 25^\circ C$ to $150^\circ C$	- 150	V
$V_{DGR}$	$T_J = 25^\circ C$ to $150^\circ C$ , $R_{GS} = 1M\Omega$	- 150	V
$V_{GSS}$	Continuous	$\pm 15$	V
$V_{GSM}$	Transient	$\pm 25$	V
$I_{D25}$	$T_C = 25^\circ C$	- 44	A
$I_{DM}$	$T_C = 25^\circ C$ , Pulse Width Limited by $T_{JM}$	-130	A
$I_A$	$T_C = 25^\circ C$	- 22	A
$E_{AS}$	$T_C = 25^\circ C$	1	J
$P_D$	$T_C = 25^\circ C$	298	W
$T_J$		-55 ... +150	$^\circ C$
$T_{JM}$		150	$^\circ C$
$T_{stg}$		-55 ... +150	$^\circ C$
$T_L$	1.6mm (0.062 in.) from Case for 10s	300	$^\circ C$
$T_{SO LD}$	Plastic Body for 10s	260	$^\circ C$
$M_d$	Mounting Torque (TO-220, TO-247 & TO-3P)	1.13/10	Nm/lb.in.
Weight	TO-263	2.5	g
	TO-220	3.0	g
	TO-3P	5.5	g
	TO-247	6.0	g

## Features

- International Standard Packages
- Avalanche Rated
- Extended FBSOA
- Fast Intrinsic Diode
- Low  $R_{DS(ON)}$  and  $Q_G$

## Advantages

- Easy to Mount
- Space Savings
- High Power Density

## Applications

- High-Side Switching
- Push Pull Amplifiers
- DC Choppers
- Automatic Test Equipment
- Current Regulators
- Battery Charger Applications

Symbol	Test Conditions ( $T_J = 25^\circ C$ , Unless Otherwise Specified)	Characteristic Values		
		Min.	Typ.	Max.
$BV_{DSS}$	$V_{GS} = 0V$ , $I_D = -250\mu A$	-150		V
$V_{GS(th)}$	$V_{DS} = V_{GS}$ , $I_D = -250\mu A$	- 2.0		V
$I_{GSS}$	$V_{GS} = \pm 15V$ , $V_{DS} = 0V$			$\pm 100$ nA
$I_{DSS}$	$V_{DS} = V_{DSS}$ , $V_{GS} = 0V$ $T_J = 125^\circ C$			- 15 $\mu A$ - 750 $\mu A$
$R_{DS(on)}$	$V_{GS} = -10V$ , $I_D = 0.5 \cdot I_{D25}$ , Note 1			65 m $\Omega$

Symbol	Test Conditions ( $T_J = 25^\circ\text{C}$ , Unless Otherwise Specified)	Characteristic Values		
		Min.	Typ.	Max.
$g_{fs}$	$V_{DS} = -10\text{V}$ , $I_D = 0.5 \cdot I_{D25}$ , Note 1	27	45	S
$C_{iss}$ $C_{oss}$ $C_{rss}$	$V_{GS} = 0\text{V}$ , $V_{DS} = -25\text{V}$ , $f = 1\text{MHz}$		13.4	nF
			675	pF
			183	pF
$t_{d(on)}$ $t_r$ $t_{d(off)}$ $t_f$	<b>Resistive Switching Times</b> $V_{GS} = -10\text{V}$ , $V_{DS} = 0.5 \cdot V_{DSS}$ , $I_D = 0.5 \cdot I_{D25}$ $R_G = 1\Omega$ (External)		25	ns
			42	ns
			50	ns
			17	ns
$Q_{g(on)}$ $Q_{gs}$ $Q_{gd}$	$V_{GS} = -10\text{V}$ , $V_{DS} = 0.5 \cdot V_{DSS}$ , $I_D = 0.5 \cdot I_{D25}$		175	nC
			65	nC
			58	nC
$R_{thJC}$ $R_{thCS}$	TO-220 TO-247 & TO-3P		0.42	$^\circ\text{C/W}$
			0.50 0.21	$^\circ\text{C/W}$ $^\circ\text{C/W}$

#### Source-Drain Diode

Symbol	Test Conditions ( $T_J = 25^\circ\text{C}$ , Unless Otherwise Specified)	Characteristic Values		
		Min.	Typ.	Max.
$I_S$	$V_{GS} = 0\text{V}$			-44 A
$I_{SM}$	Repetitive, Pulse Width Limited by $T_{JM}$			-176 A
$V_{SD}$	$I_F = I_S$ , $V_{GS} = 0\text{V}$ , Note 1			-1.3 V
$t_{rr}$ $Q_{RM}$ $I_{RM}$	$I_F = -22\text{A}$ , $-di/dt = -100\text{A}/\mu\text{s}$ $V_R = -75\text{V}$ , $V_{GS} = 0\text{V}$		140	ns
			0.87	$\mu\text{C}$
			-12.4	A

Note 1. Pulse test,  $t \leq 300\mu\text{s}$ , duty cycle,  $d \leq 2\%$ .

IXYS Reserves the Right to Change Limits, Test Conditions, and Dimensions.

IXYS MOSFETs and IGBTs are covered by one or more of the following U.S. patents:	4,835,592	4,931,844	5,049,961	5,237,481	6,162,665	6,404,065 B1	6,683,344	6,727,585	7,005,734 B2	7,157,338B2
	4,860,072	5,017,508	5,063,307	5,381,025	6,259,123 B1	6,534,343	6,710,405 B2	6,759,692	7,063,975 B2	
	4,881,106	5,034,796	5,187,117	5,486,715	6,306,728 B1	6,583,505	6,710,463	6,771,478 B2	7,071,537	

### TO-247 Outline

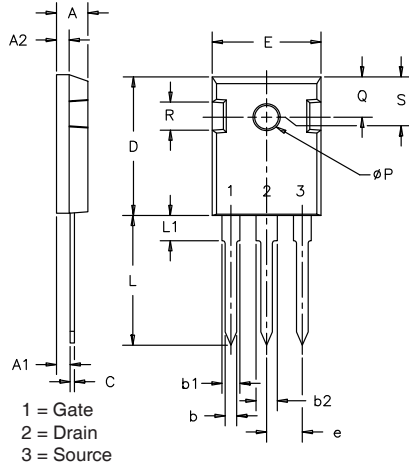

SYM	INCHES		MILLIMETERS	
	MIN	MAX	MIN	MAX
A	.185	.209	4.7	5.3
A1	.087	.102	2.2	2.54
A2	.059	.098	2.2	2.6
b	.040	.055	1.0	1.4
b1	.065	.084	1.65	2.13
b2	.113	.123	2.87	3.12
C	.016	.031	.4	.8
D	.819	.845	20.80	21.46
E	.610	.640	15.75	16.26
e	.215 BSC		5.45 BSC	
L	.780	.800	19.81	20.32
L1		.177		4.50
phi P	.140	.144	3.55	3.65
Q	.212	.244	5.4	6.2
R	.170	.216	4.32	5.49
S	.242 BSC		6.15 BSC	

### TO-220 Outline

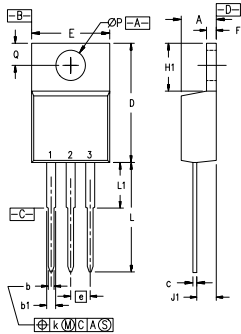

Pins: 1 - Gate 2 - Drain  
3 - Source

SYM	INCHES		MILLIMETERS	
	MIN	MAX	MIN	MAX
A	.170	.190	4.32	4.83
b	.025	.040	0.64	1.02
b1	.045	.065	1.15	1.65
c	.014	.022	0.35	0.56
D	.580	.630	14.73	16.00
E	.390	.420	9.91	10.66
e	.100 BSC		2.54 BSC	
F	.045	.055	1.14	1.40
H1	.230	.270	5.85	6.85
J1	.090	.110	2.29	2.79
k	0	.015	0	0.38
L	.500	.550	12.70	13.97
L1	.110	.230	2.79	5.84
phi P	.139	.161	3.53	4.08
Q	.100	.125	2.54	3.18

### TO-3P Outline

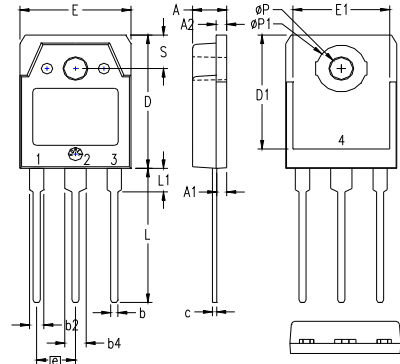

Pins: 1 - Gate 2,4 - Drain  
3 - Source

SYM	INCHES		MILLIMETERS	
	MIN	MAX	MIN	MAX
A	.185	.193	4.70	4.90
A1	.051	.059	1.30	1.50
A2	.057	.065	1.45	1.65
b	.035	.045	0.90	1.15
b2	.075	.087	1.90	2.20
b4	.114	.126	2.90	3.20
c	.022	.031	0.55	0.80
D	.780	.791	19.80	20.10
D1	.665	.677	16.90	17.20
E	.610	.622	15.50	15.80
E1	.531	.539	13.50	13.70
e	.215 BSC		5.45 BSC	
L	.779	.795	19.80	20.20
L1	.134	.142	3.40	3.60
phi P	.126	.134	3.20	3.40
phi P1	.272	.280	6.90	7.10
S	.193	.201	4.90	5.10

All metal area are tin plated.

### TO-263 Outline

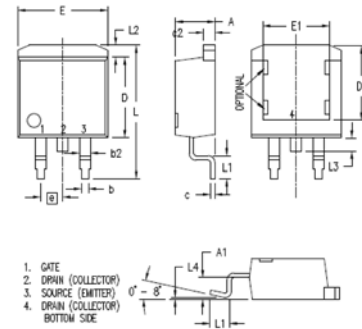

SYM	INCHES		MILLIMETERS	
	MIN	MAX	MIN	MAX
A	.160	.190	4.06	4.83
A1	.080	.110	2.03	2.79
b	.020	.039	0.51	0.99
b2	.045	.055	1.14	1.40
c	.016	.029	0.40	0.74
c2	.045	.055	1.14	1.40
D	.340	.380	8.64	9.65
D1	.315	.350	8.00	8.89
E	.380	.410	9.65	10.41
E1	.245	.320	6.22	8.13
e	.100 BSC		2.54 BSC	
L	.575	.625	14.61	15.88
L1	.090	.110	2.29	2.79
L2	.040	.055	1.02	1.40
L3	.050	.070	1.27	1.78
L4	0	.005	0	0.13

Fig. 1. Output Characteristics @  $T_J = 25^\circ\text{C}$

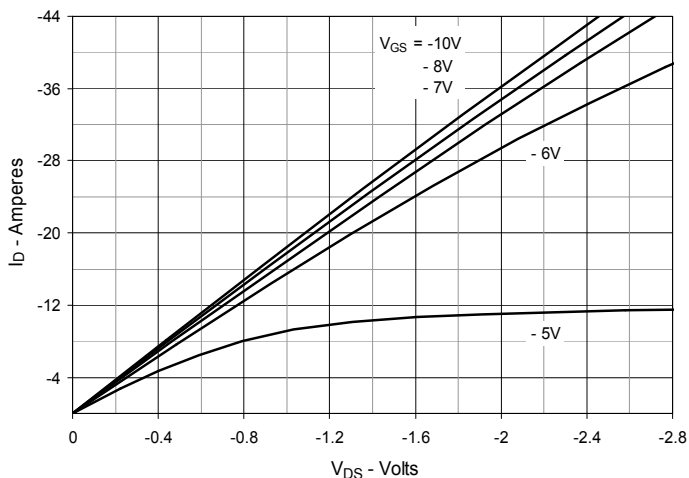

Fig. 2. Extended Output Characteristics @  $T_J = 25^\circ\text{C}$

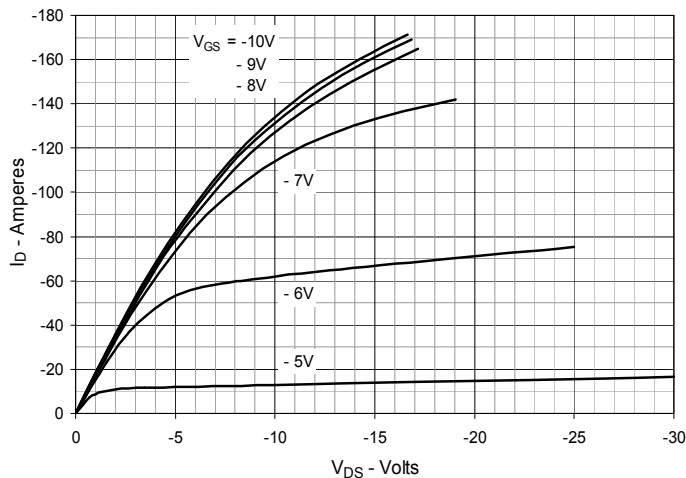

Fig. 3. Output Characteristics @  $T_J = 125^\circ\text{C}$

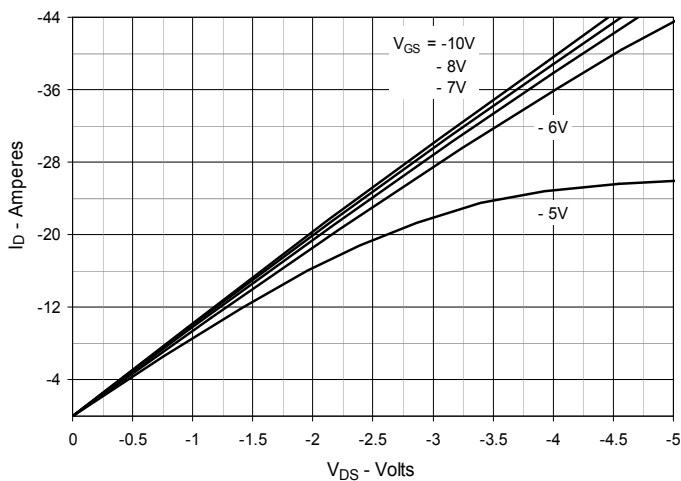

Fig. 4.  $R_{DS(on)}$  Normalized to  $I_D = -22\text{A}$  Value vs. Junction Temperature

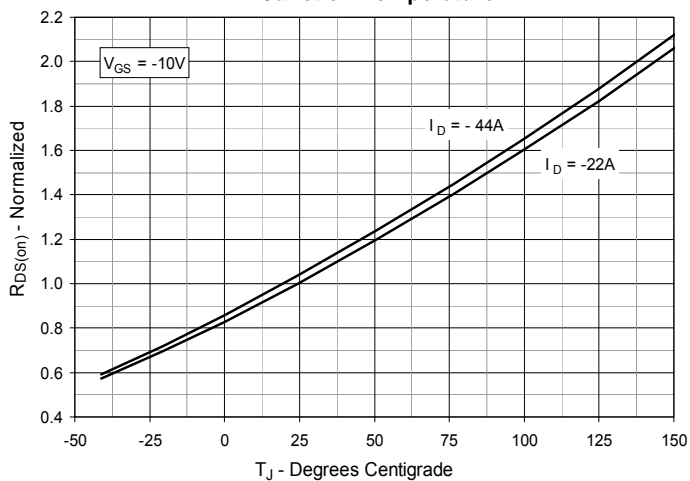

Fig. 5.  $R_{DS(on)}$  Normalized to  $I_D = -22\text{A}$  Value vs. Drain Current

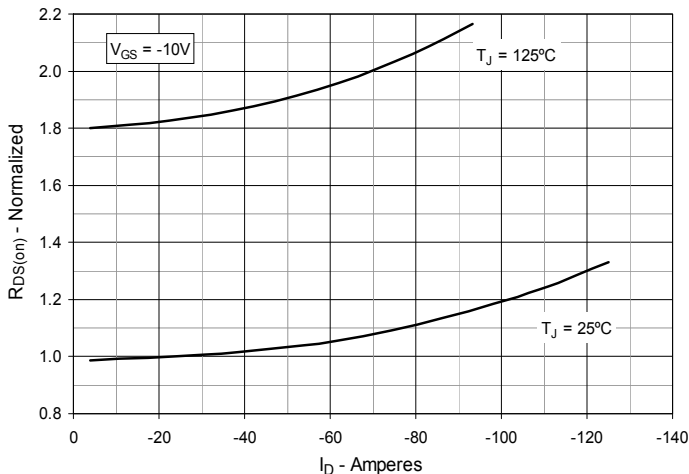

Fig. 6. Maximum Drain Current vs. Case Temperature

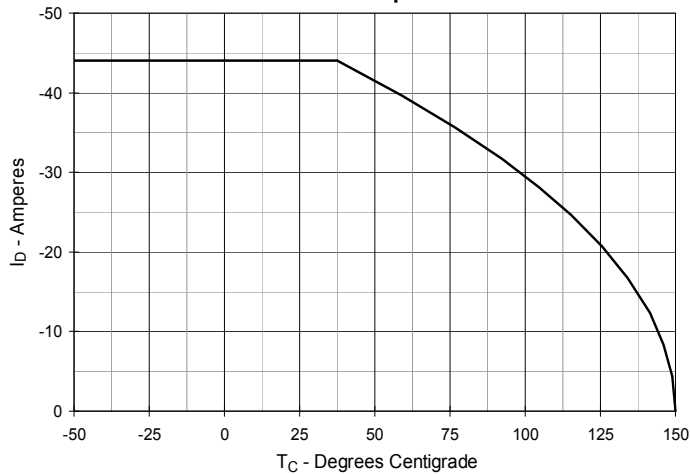

Fig. 7. Input Admittance

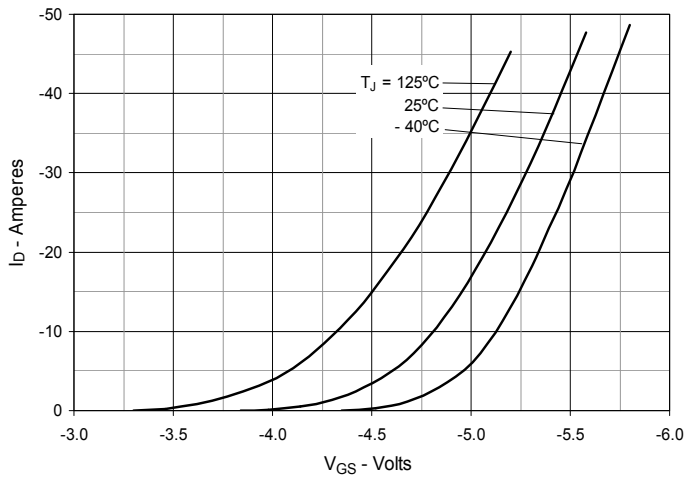

Fig. 8. Transconductance

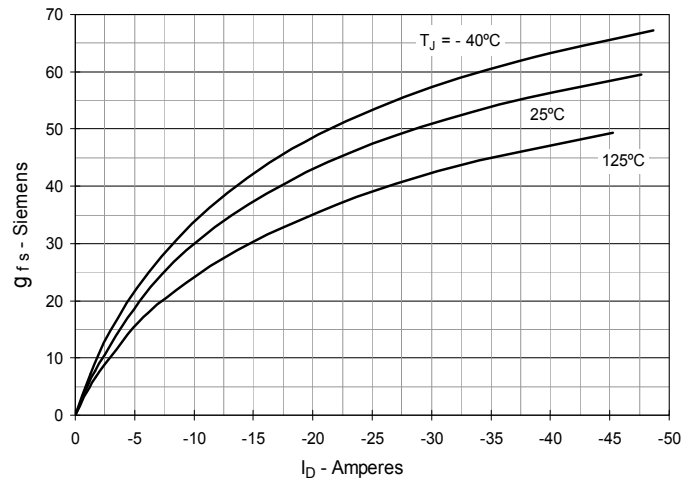

Fig. 9. Forward Voltage Drop of Intrinsic Diode

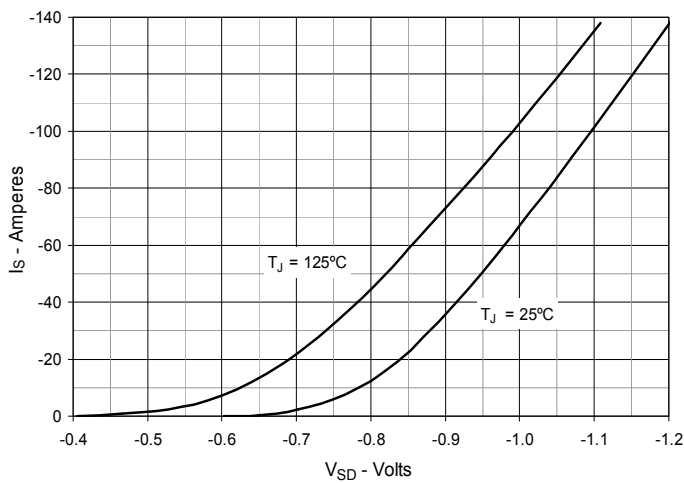

Fig. 10. Gate Charge

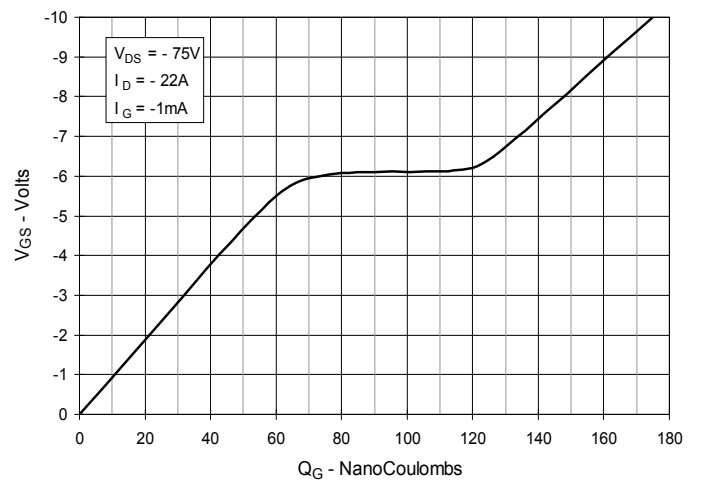

Fig. 11. Capacitance

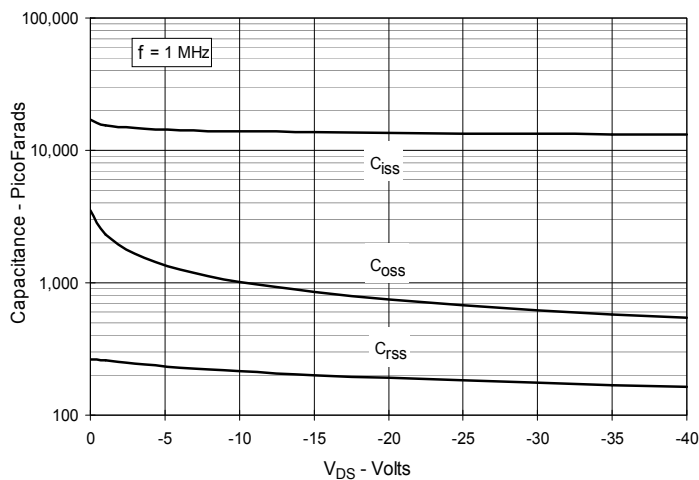
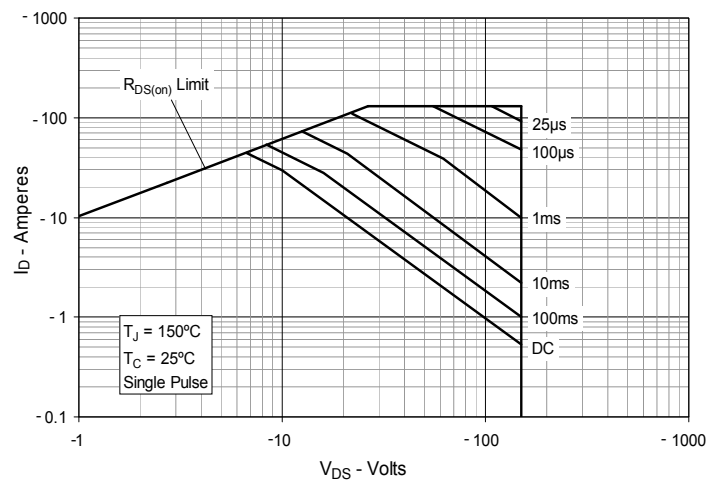
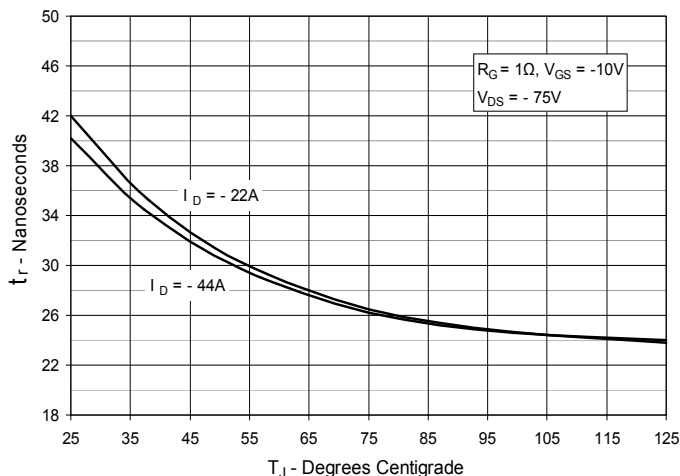

Fig. 12. Forward-Bias Safe Operating Area



**Fig. 13. Resistive Turn-on Rise Time vs. Junction Temperature**



**Fig. 14. Resistive Turn-on Rise Time vs. Drain Current**

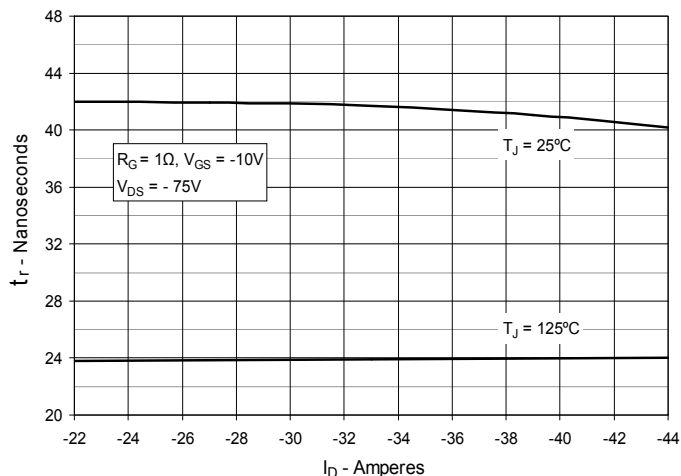

**Fig. 15. Resistive Turn-on Switching Times vs. Gate Resistance**

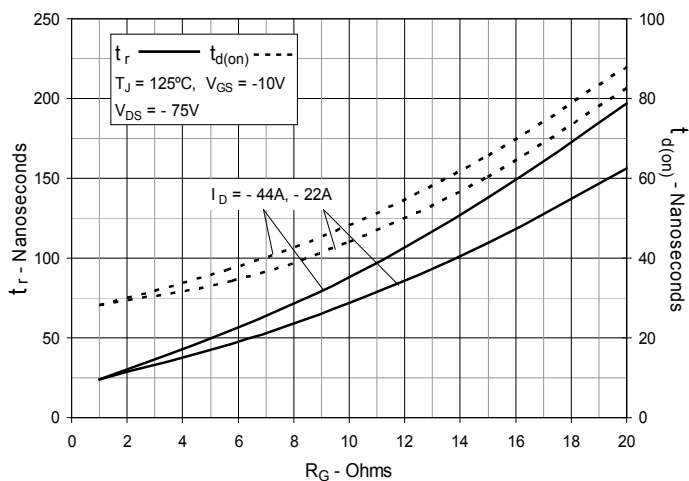

**Fig. 16. Resistive Turn-off Switching Times vs. Junction Temperature**

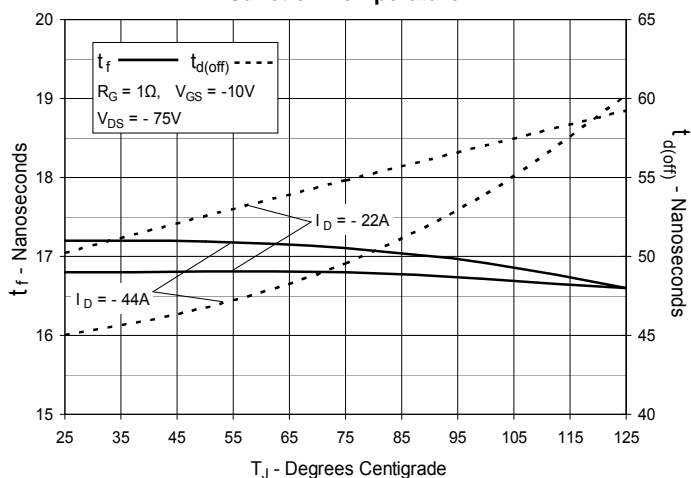

**Fig. 17. Resistive Turn-off Switching Times vs. Drain Current**

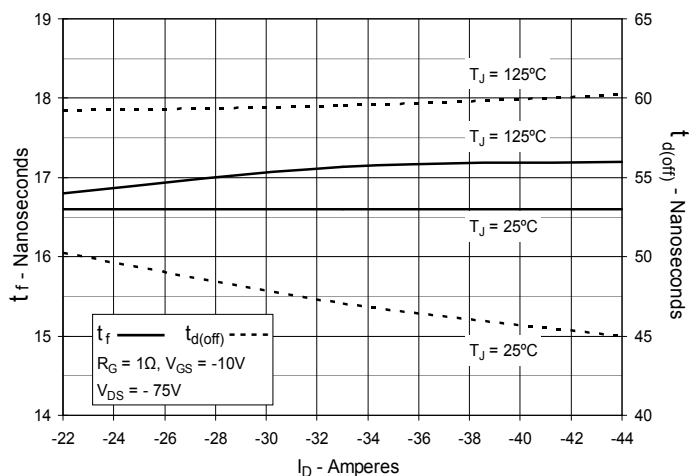

**Fig. 18. Resistive Turn-off Switching Times vs. Gate Resistance**

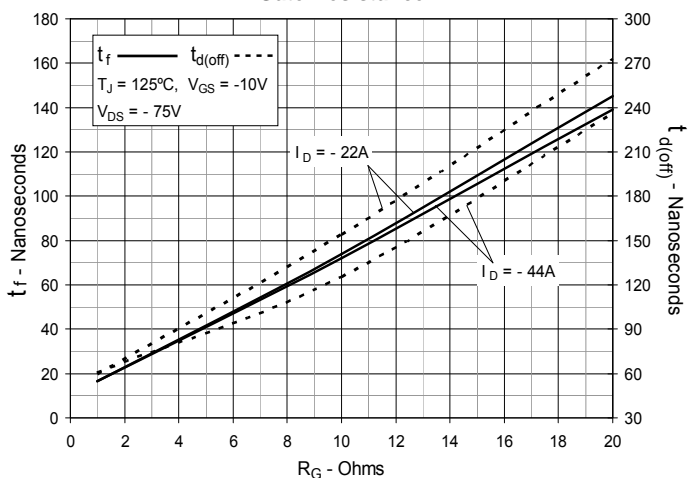
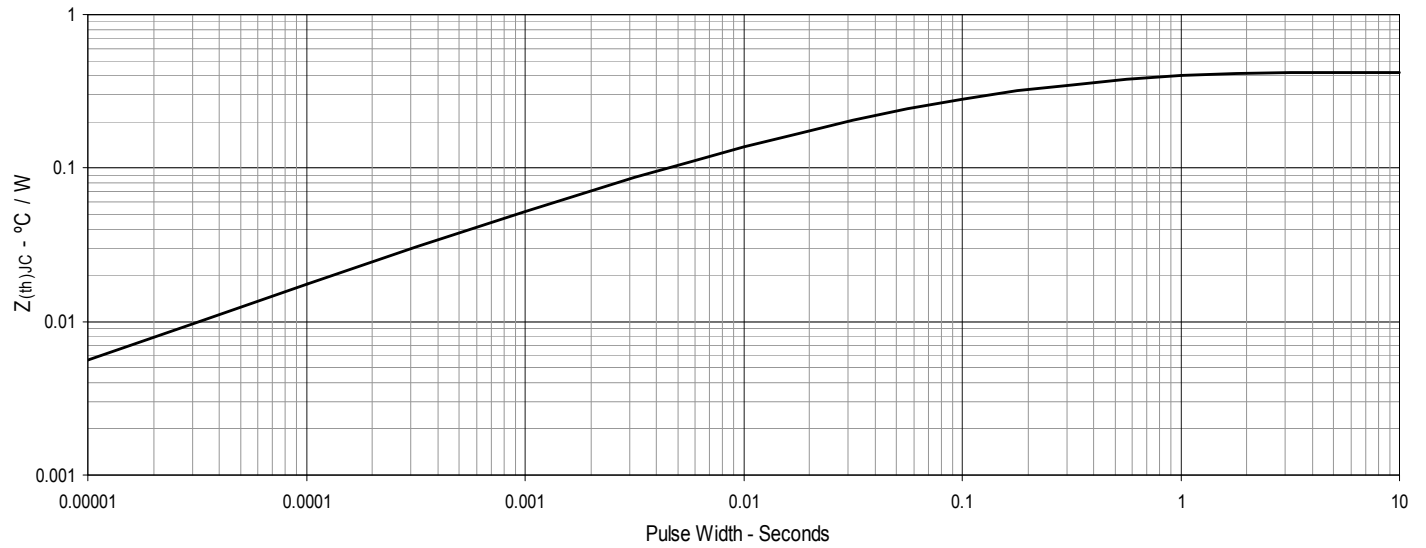

Fig. 19. Maximum Transient Thermal Impedance





---

Disclaimer Notice - Information furnished is believed to be accurate and reliable. However, users should independently evaluate the suitability of and test each product selected for their own applications. Littelfuse products are not designed for, and may not be used in, all applications. Read complete Disclaimer Notice at [www.littelfuse.com/disclaimer-electronics](http://www.littelfuse.com/disclaimer-electronics).

## Looking for pricing, stock, or lifecycle information?

Click below to explore more details on WIN SOURCE:

 [View IXTH44P15T on WIN SOURCE](#)

 [IXYS Information](#)

## Optimize Your Supply Chain with WIN SOURCE Solutions

-  Global Sourcing Solution
-  Obsolete Management
-  Cost Control Management
-  Shortage Management
-  Alternative Solution
-  Excess Inventory Management