



**THE DATASHEET OF
SQ9945AEY-T1-E3**



Automotive Dual N-Channel 60 V (D-S) 175 °C MOSFET

PRODUCT SUMMARY	
V_{DS} (V)	60
$R_{DS(on)}$ (Ω) at $V_{GS} = 10$ V	0.080
I_D (A)	± 3.7
Configuration	Dual

FEATURES

- TrenchFET® Power MOSFET
- Package with Low Thermal Resistance

AEC-Q101 RELIABILITY

- Passed all AEC-Q101 Reliability Testing
- Characterization Ongoing

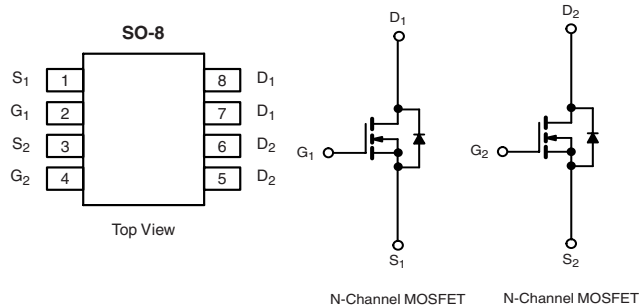
RoHS*
COMPLIANT

ORDERING INFORMATION	
Package	SO-8
Lead (Pb)-free	SQ9945AEY-T1-E3
SnPb	SQ9945AEY-T1

ABSOLUTE MAXIMUM RATINGS $T_C = 25$ °C, unless otherwise noted			
PARAMETER	SYMBOL	LIMIT	UNIT
Drain-Source Voltage	V_{DS}	60	V
Gate-Source Voltage	V_{GS}	± 20	
Continuous Drain Current ^a	I_D	$T_C = 25$ °C	- 3.7
		$T_C = 70$ °C	- 3.2
Continuous Source Current (Diode Conduction) ^a	I_S	2	A
Pulsed Drain Current ^b	I_{DM}	25	
Single Pulse Avalanche Energy	E_{AS}	-	mJ
Single Pulse Avalanche Current			
Maximum Power Dissipation ^b	P_D	$T_C = 25$ °C	2.4
		$T_A = 70$ °C	1.7
Operating Junction and Storage Temperature Range	T_J, T_{stg}	- 55 to + 175	°C

THERMAL RESISTANCE RATINGS			
PARAMETER	SYMBOL	LIMIT	UNIT
Junction-to-Ambient	R_{thJA}	-	°C/W
Junction-to-Case (Drain)			

Notes

- Package limited.
- Pulse test; pulse width ≤ 300 μ s, duty cycle ≤ 2 %.
- When mounted on 1" square PCB (FR-4 material).

* Pb containing terminations are not RoHS compliant, exemptions may apply



SPECIFICATIONS $T_C = 25\text{ }^\circ\text{C}$, unless otherwise noted						
PARAMETER	SYMBOL	TEST CONDITIONS	MIN.	TYP.	MAX.	UNIT
Static						
Drain-Source Breakdown Voltage	V_{DS}	$V_{GS} = 0\text{ V}, I_D = 250\text{ }\mu\text{A}$	-	-	-	V
Gate-Source Threshold Voltage	$V_{GS(th)}$	$V_{DS} = V_{GS}, I_D = 250\text{ }\mu\text{A}$	1.0	-	3.0	
Gate-Source Leakage	I_{GSS}	$V_{DS} = 0\text{ V}, V_{GS} = \pm 20\text{ V}$	-	-	± 100	nA
Zero Gate Voltage Drain Current	I_{DSS}	$V_{GS} = 0\text{ V}, V_{DS} = 60\text{ V}$	-	-	1.0	μA
		$V_{GS} = 0\text{ V}, V_{DS} = 60\text{ V}$	-	-	10	
		$V_{GS} = 0\text{ V}, V_{DS} = 60\text{ V}, T_J = 55\text{ }^\circ\text{C}$	-	-	-	
On-State Drain Current ^a	$I_{D(on)}$	$V_{GS} = 10\text{ V}, V_{DS} \geq 5\text{ V}$	20	-	-	A
Drain-Source On-State Resistance ^a	$R_{DS(on)}$	$V_{GS} = 10\text{ V}, I_D = 3.7\text{ A}$	-	0.060	0.080	Ω
		$V_{GS} = 10\text{ V}, I_D = 30\text{ A}, T_J = 125\text{ }^\circ\text{C}$	-	-	-	
		$V_{GS} = 10\text{ V}, I_D = 30\text{ A}, T_J = 175\text{ }^\circ\text{C}$	-	-	-	
Forward Transconductance ^a	g_{fs}	$V_{DS} = 15\text{ V}, I_D = 3.7\text{ A}$	-	-	11	S
Dynamic^b						
Input Capacitance	C_{iss}	$V_{GS} = 0\text{ V}, V_{DS} = 25\text{ V}, f = 1\text{ MHz}$	-	-	-	pF
Output Capacitance	C_{oss}		-	-	-	
Reverse Transfer Capacitance	C_{rss}		-	-	-	
Total Gate Charge ^c	Q_g	$V_{GS} = 10\text{ V}, V_{DS} = 30\text{ V}, I_D = 3.7\text{ A}$	-	11	20	nC
Gate-Source Charge ^c	Q_{gs}		-	2	-	
Gate-Drain Charge ^c	Q_{gd}		-	2	-	
Turn-On Delay Time ^c	$t_{d(on)}$	$V_{DD} = 30\text{ V}, R_L = 30\text{ }\Omega, I_D \cong 1\text{ A}, V_{GEN} = 10\text{ V}, R_g = 6\text{ }\Omega$	-	9	20	ns
Rise Time ^c	t_r		-	10	20	
Turn-Off Delay Time ^c	$t_{d(off)}$		-	21	40	
Fall Time ^c	t_f		-	8	20	
Source-Drain Diode Ratings and Characteristics $T_C = 25\text{ }^\circ\text{C}$ ^b						
Pulsed Current ^a	I_{SM}		-	-	-	A
Forward Voltage	V_{SD}	$I_F = 85\text{ A}, V_{GS} = 0\text{ V}$	-	-	-	V
Reverse Recovery Time	t_{rr}	$I_F = 2\text{ A}, di/dt = 100\text{ A}/\mu\text{s}$	-	45	80	ns
Peak Reverse Recovery Current	$I_{RM(REC)}$		-	-	-	A
Reverse Recovery Charge	Q_{rr}		-	-	-	μC

Notes

- a. Pulse test; pulse width $\leq 300\text{ }\mu\text{s}$, duty cycle $\leq 2\%$.
- b. Guaranteed by design, not subject to production testing.
- c. Independent of operating temperature.

Stresses beyond those listed under "Absolute Maximum Ratings" may cause permanent damage to the device. These are stress ratings only, and functional operation of the device at these or any other conditions beyond those indicated in the operational sections of the specifications is not implied. Exposure to absolute maximum rating conditions for extended periods may affect device reliability.

TYPICAL CHARACTERISTICS $T_A = 25\text{ }^\circ\text{C}$, unless otherwise noted

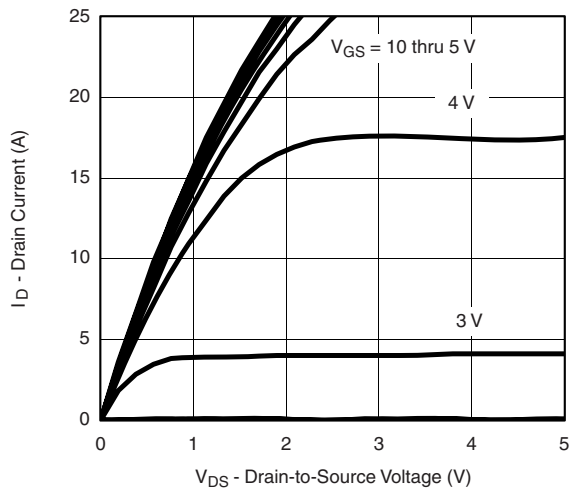

Output Characteristics

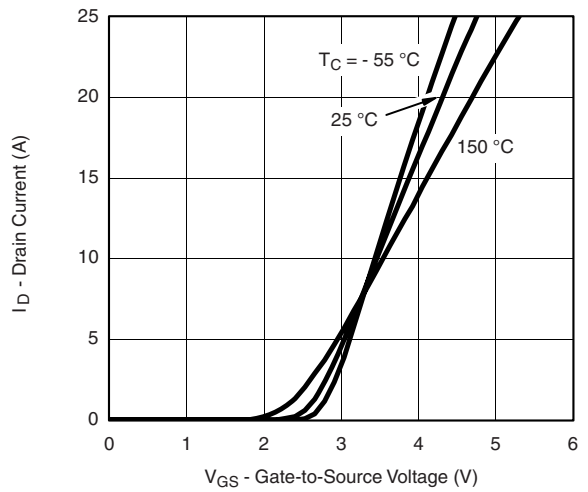

Transfer Characteristics

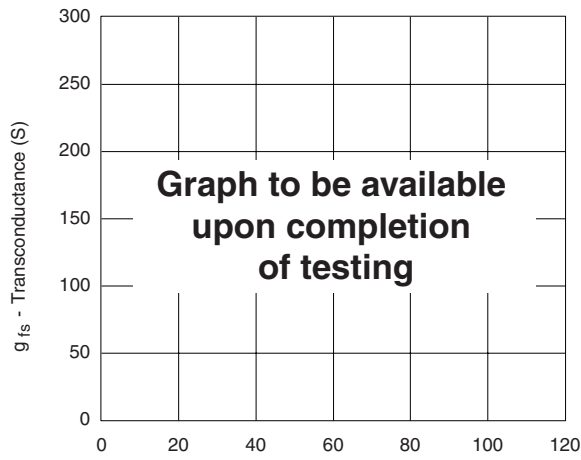

Transconductance

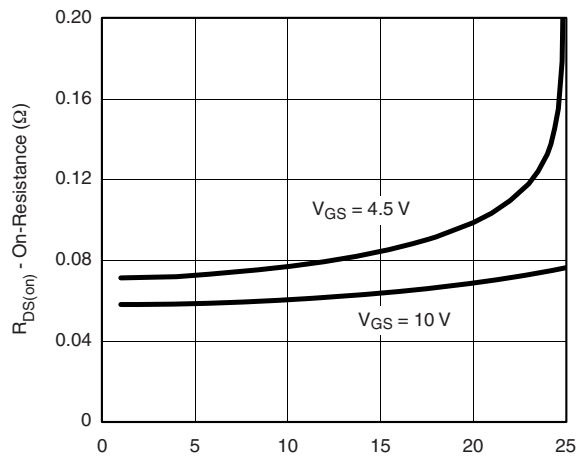

On-Resistance vs. Drain Current

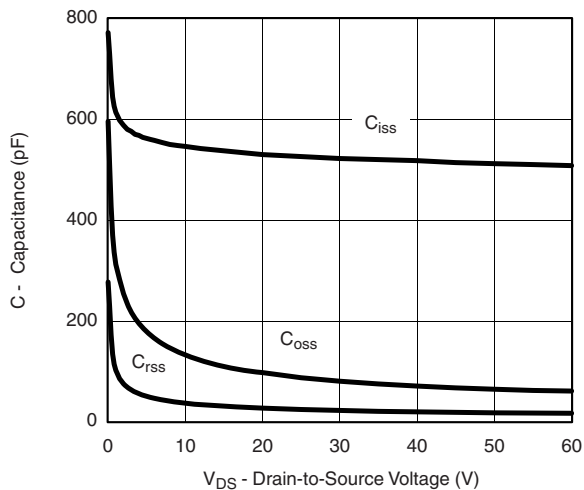

Capacitance

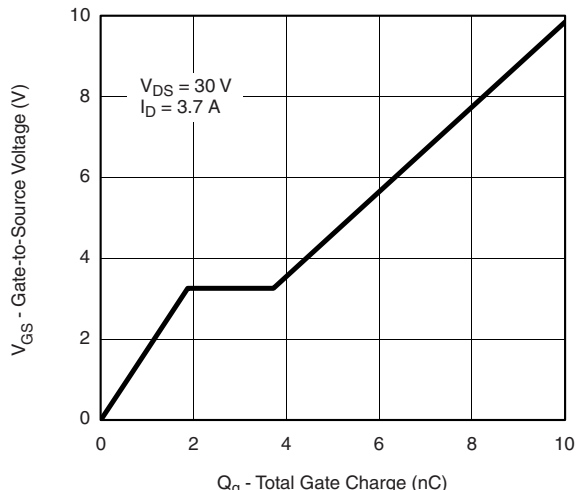

Gate Charge

TYPICAL CHARACTERISTICS $T_A = 25\text{ }^\circ\text{C}$, unless otherwise noted

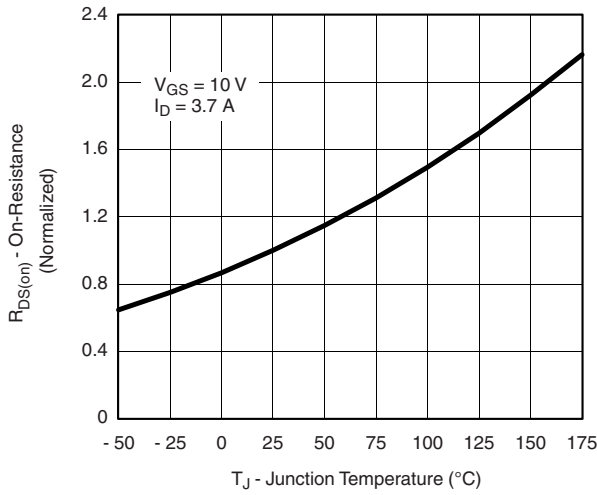

On-Resistance vs. Junction Temperature

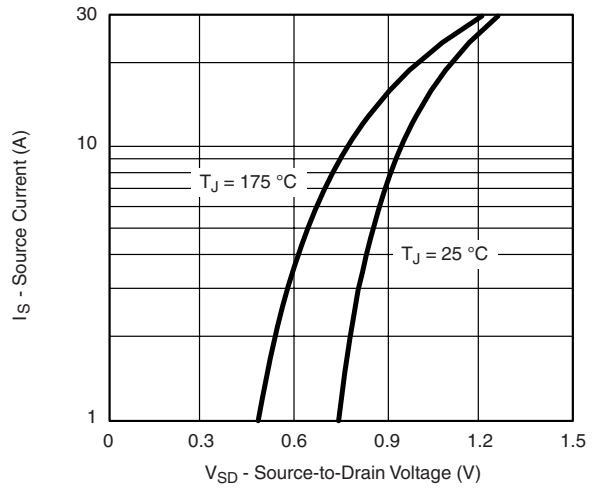

Source Drain Diode Forward Voltage

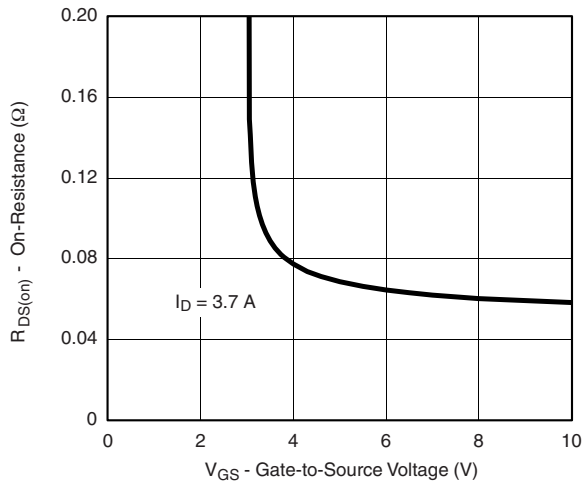

On-Resistance vs. Gate-to-Source Voltage

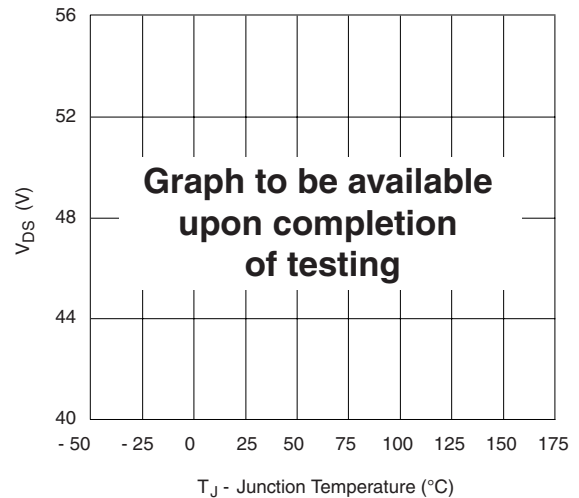

Drain Source Breakdown vs. Junction Temperature

THERMAL RATINGS $T_A = 25\text{ }^\circ\text{C}$, unless otherwise noted

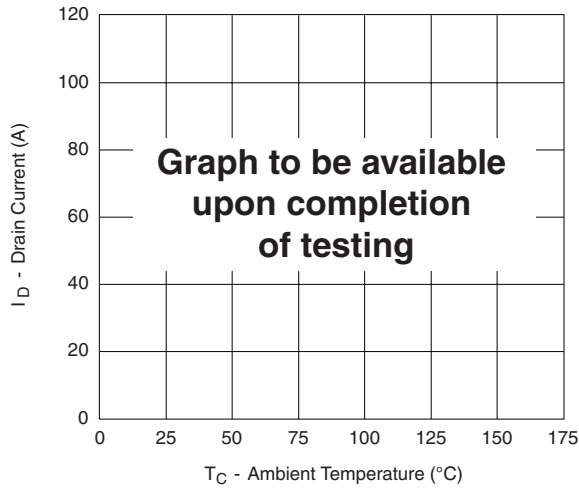

Maximum Drain Current vs. Ambient Temperature

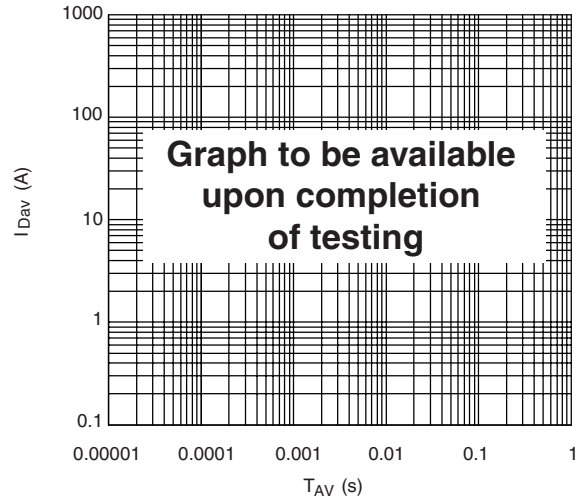

Avalanche Current vs. Time

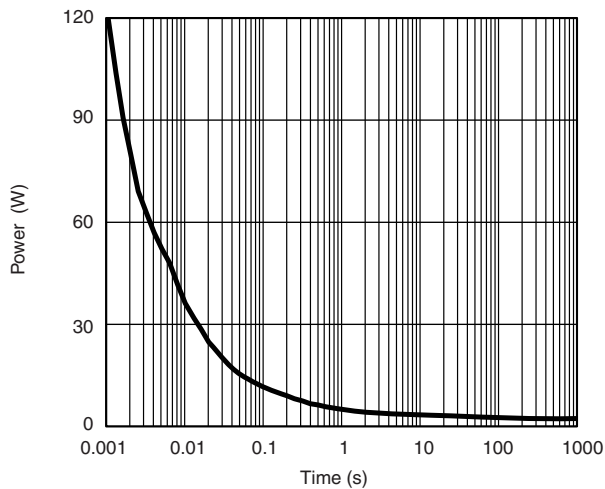

Single Pulse Power, Junction-to-Ambient

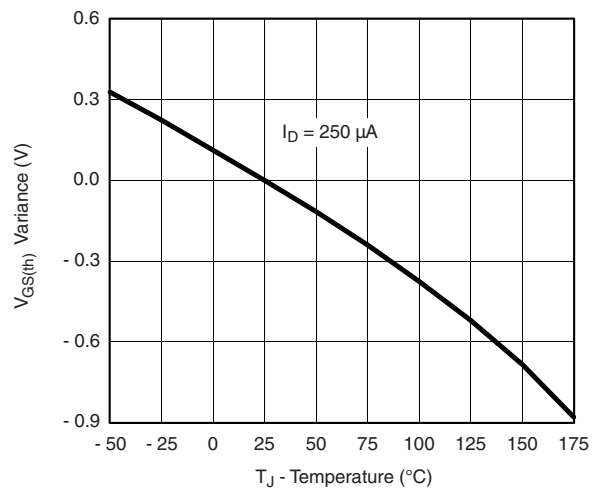

Threshold Voltage

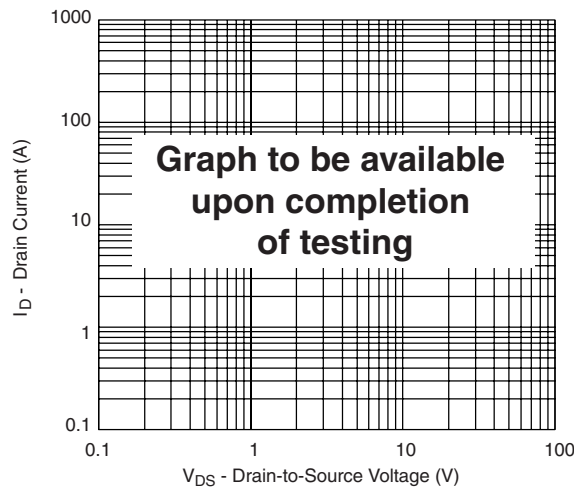

* $V_{GS} >$ minimum V_{GS} at which $R_{DS(on)}$ is specified

Safe Operating Area

THERMAL RATINGS $T_A = 25\text{ }^\circ\text{C}$, unless otherwise noted

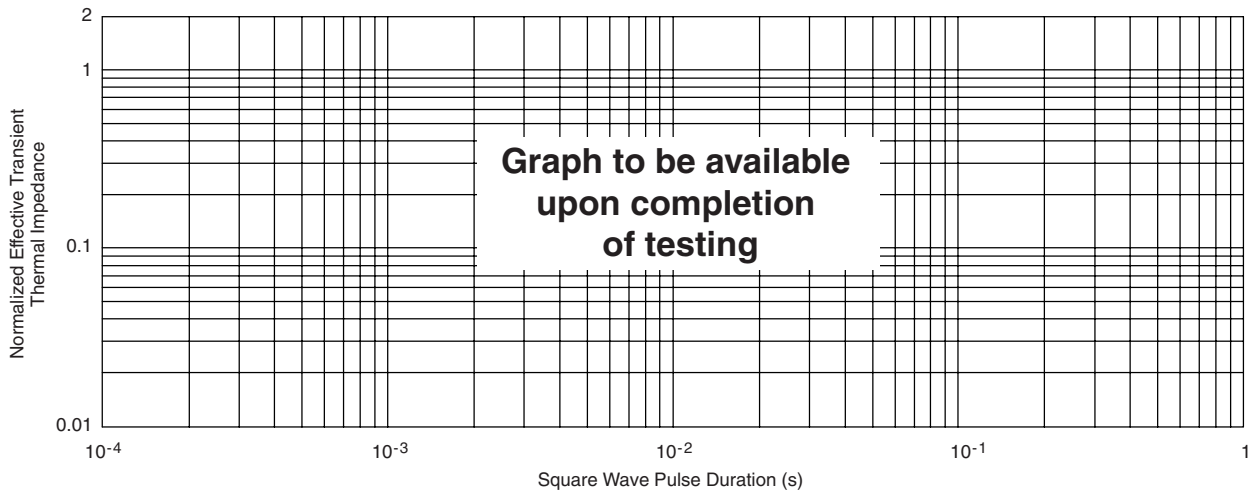

Normalized Thermal Transient Impedance, Junction-to-Case

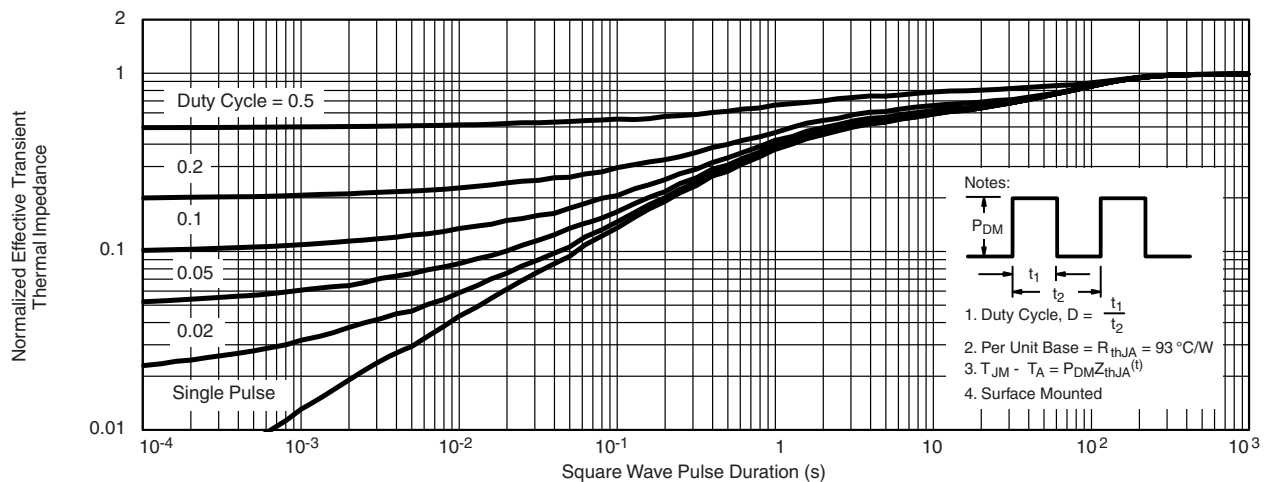

Normalized Thermal Transient Impedance, Junction-to-Ambient

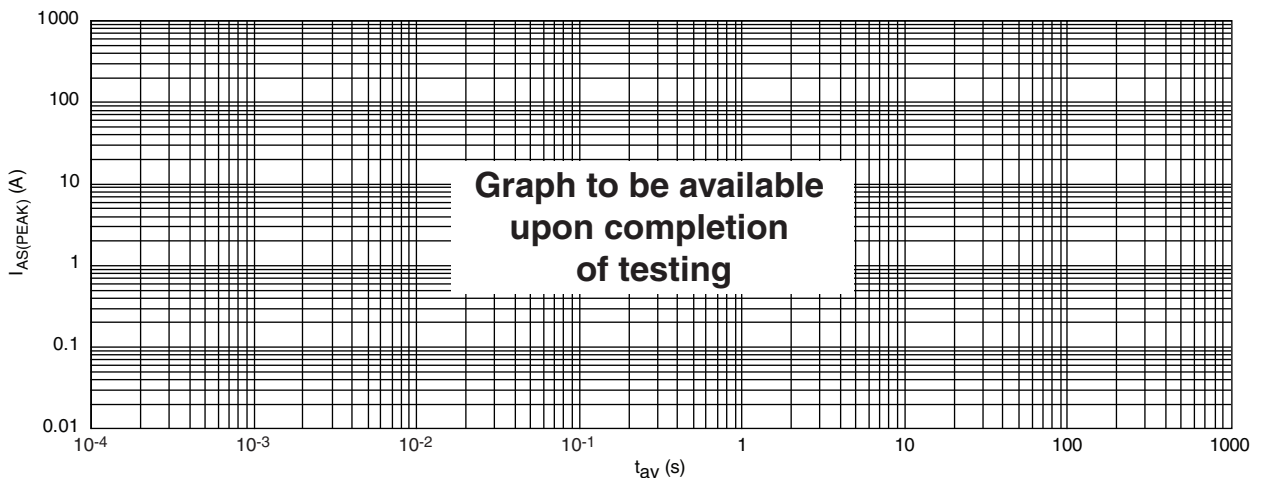

Single Pulse Avalanche Current (Peak) vs. Time in Avalanche

THERMAL RATINGS $T_A = 25\text{ }^\circ\text{C}$, unless otherwise noted

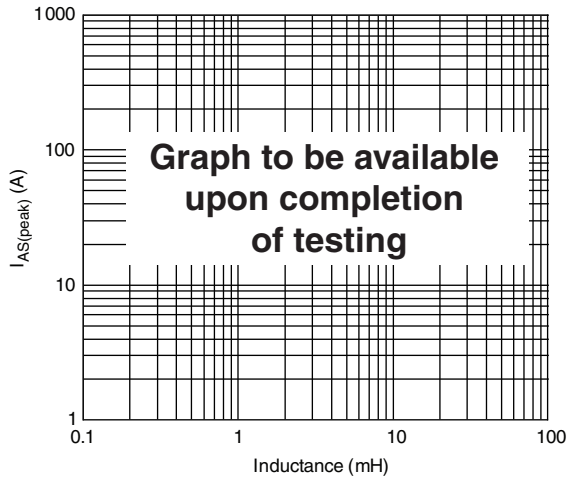

Single Pulse Avalanche Current (Peak) vs. Inductance

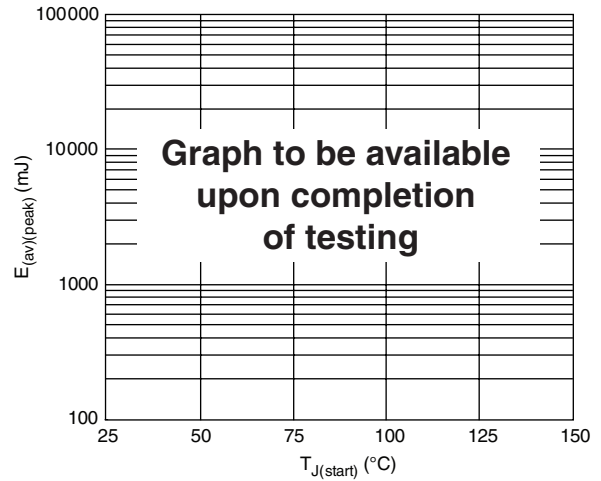

Single Pulse Avalanche Energy (Peak) vs. $T_{J(\text{start})}$

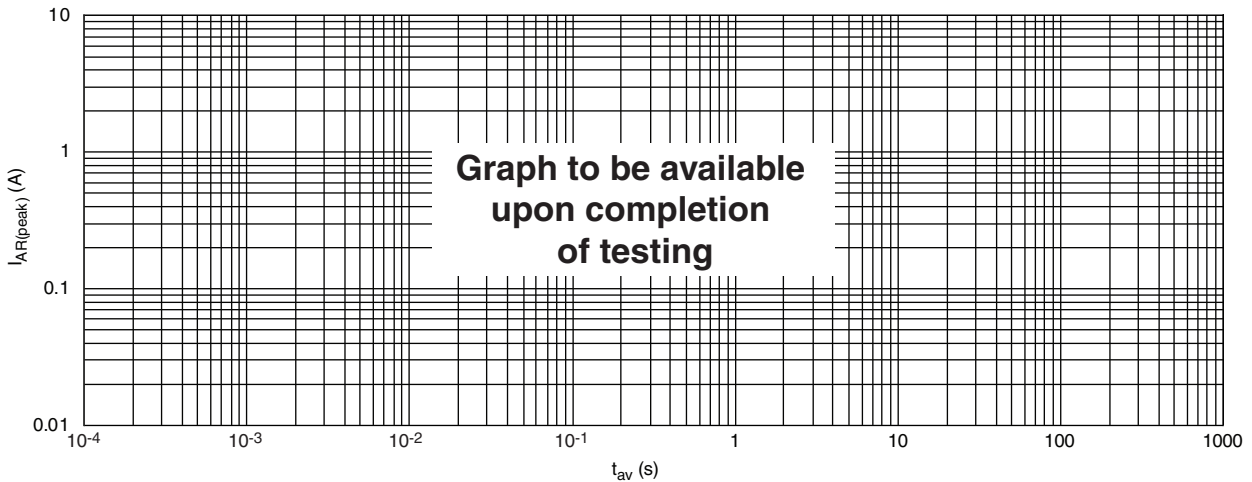

Repetitive Avalanche Current (Peak) vs. Time in Avalanche at $T_A = 25\text{ }^\circ\text{C}$

THERMAL RATINGS $T_A = 25\text{ }^\circ\text{C}$, unless otherwise noted

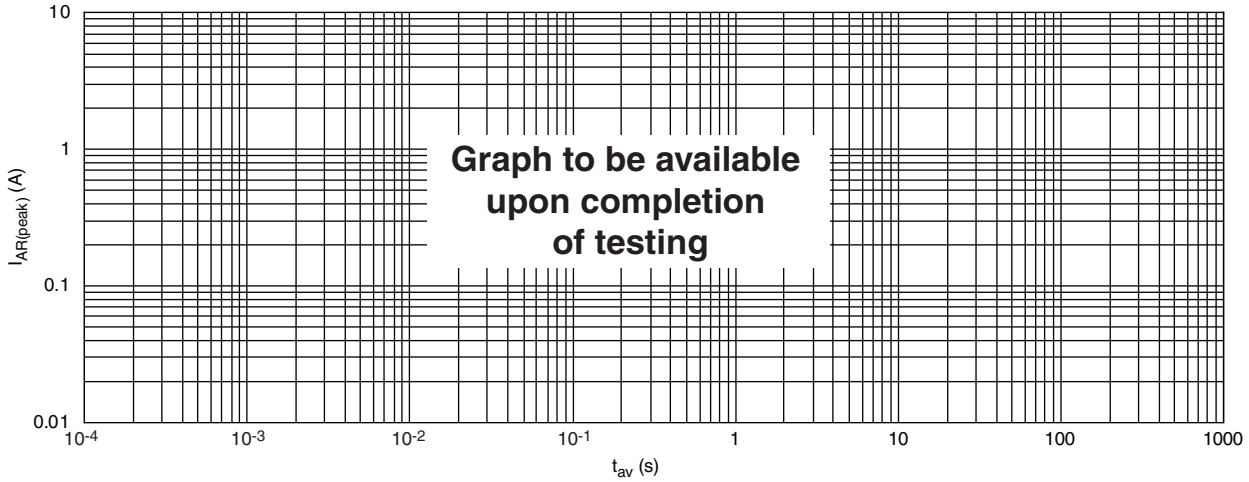

Repetitive Avalanche Current (Peak) vs. Time in Avalanche at $T_A = 150\text{ }^\circ\text{C}$

Note

The characteristics shown in the six graphs

- Normalized Transient Thermal Impedance Junction to Ambient ($25\text{ }^\circ\text{C}$)
- Single Pulse Avalanche Current (Peak) vs. Time in Avalanche
- Single Pulse Avalanche Current (Peak) vs. Inductance
- Single Pulse Avalanche Energy (Peak) vs. $T_{J(\text{start})}$
- Repetitive Avalanche Current (Peak) vs. Time in Avalanche at $T_A = 25\text{ }^\circ\text{C}$
- Repetitive Avalanche Current (Peak) vs. Time in Avalanche at $T_A = 150\text{ }^\circ\text{C}$

are given for general guidelines only to enable the user to get a "ball park" indication of part capabilities. The data are extracted from single pulse transient thermal impedance characteristics which are developed from empirical measurements. The latter is valid for the part mounted on printed circuit board - FR4, size 1" x 1" x 0.062", double sided with 2 oz. copper, 100 % on both sides. The part capabilities can widely vary depending on actual application parameters and operating conditions.

Vishay Siliconix maintains worldwide manufacturing capability. Products may be manufactured at one of several qualified locations. Reliability data for Silicon Technology and Package Reliability represent a composite of all qualified locations. For related documents such as package/tape drawings, part marking, and reliability data, see <http://www.vishay.com/ppg?74499>.



Disclaimer

All product specifications and data are subject to change without notice.

Vishay Intertechnology, Inc., its affiliates, agents, and employees, and all persons acting on its or their behalf (collectively, "Vishay"), disclaim any and all liability for any errors, inaccuracies or incompleteness contained herein or in any other disclosure relating to any product.

Vishay disclaims any and all liability arising out of the use or application of any product described herein or of any information provided herein to the maximum extent permitted by law. The product specifications do not expand or otherwise modify Vishay's terms and conditions of purchase, including but not limited to the warranty expressed therein, which apply to these products.

No license, express or implied, by estoppel or otherwise, to any intellectual property rights is granted by this document or by any conduct of Vishay.

The products shown herein are not designed for use in medical, life-saving, or life-sustaining applications unless otherwise expressly indicated. Customers using or selling Vishay products not expressly indicated for use in such applications do so entirely at their own risk and agree to fully indemnify Vishay for any damages arising or resulting from such use or sale. Please contact authorized Vishay personnel to obtain written terms and conditions regarding products designed for such applications.

Product names and markings noted herein may be trademarks of their respective owners.

Looking for pricing, stock, or lifecycle information?

Click below to explore more details on WIN SOURCE:

 [View SQ9945AEY-T1-E3 on WIN SOURCE](#)

 [Vishay Information](#)

Optimize Your Supply Chain with WIN SOURCE Solutions

-  Global Sourcing Solution
-  Obsolete Management
-  Cost Control Management
-  Shortage Management
-  Alternative Solution
-  Excess Inventory Management