



**THE DATASHEET OF
NCP584HSN28T1G**



NCP584

Tri-Mode 200 mA CMOS LDO Regulator with Enable

The NCP584 series of low drop out regulators are designed for portable battery powered applications which require precise output voltage accuracy, low quiescent current, and high ripple rejection. These devices feature an enable function which lowers current consumption significantly and are offered in the SOT23-5 package.

This series of devices have three modes. Chip Enable (CE mode), Fast Transient Mode (FT mode), and Low Power Mode (LP mode). Both the FT and LP mode are utilized via the ECO pin.

Features

- Tri-mode Operation
- Low Dropout Voltage of 400 mV at 200 mA, Output Voltage = 0.9 V
300 mV at 200 mA, Output Voltage = 1.2 V
200 mV at 200 mA, Output Voltage = 1.8 V
- Excellent Line Regulation of 0.05%/V (0.10% LP Mode)
- Excellent Load Regulation of 10 mV (20 mV FT Mode)
- High Output Voltage Accuracy of $\pm 2\%$ ($\pm 3\%$ LP mode)
- Ultra-Low Iq Current of:
3.5 μA (LP mode, Output Voltage ≤ 1.5 V)
40 μA (FT mode)
- Very Low Shutdown Current of 0.1 μA
- Excellent Power Supply Rejection Ratio of 75 dB at $f = 1.0$ kHz
- Low Temperature Drift Coefficient on the Output Voltage of ± 100 ppm/ $^{\circ}\text{C}$
- Fold Back Protection Circuit
- Input Voltage up to 6.5 V
- These are Pb-Free Devices

Typical Applications

- Portable Equipment
- Hand-Held Instrumentation
- Camcorders and Cameras

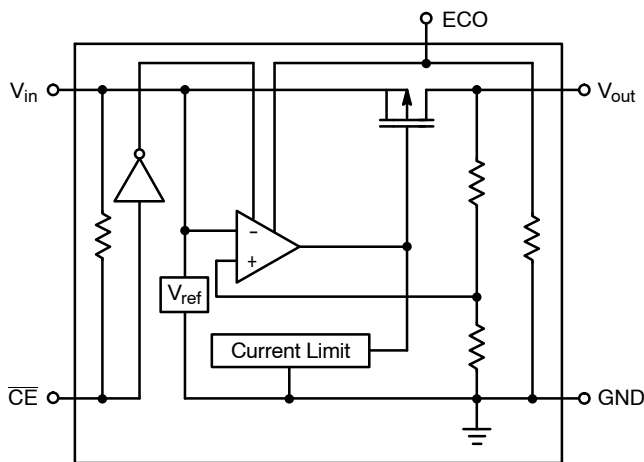

Figure 1. Simplified Block Diagram for Active Low

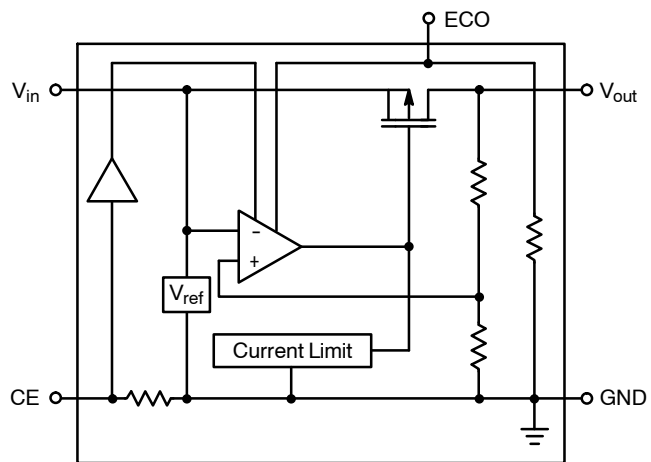

Figure 2. Simplified Block Diagram for Active High



ON Semiconductor®

<http://onsemi.com>

MARKING DIAGRAM



SOT23-5
SN SUFFIX
CASE 1212

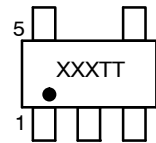

XXX = Specific Device Code
TT = Traceability Information

ORDERING INFORMATION

See detailed ordering and shipping information in the package dimensions section on page 13 of this data sheet.

*Additional voltage options may be available between 0.8 V and 3.3 V in 100 mV steps.

NCP584

PIN FUNCTION DESCRIPTION

| SOT23-5 | Pin Name | Description |
|---------|-----------------------|--|
| 1 | V_{in} | Power supply input voltage. |
| 2 | GND | Power supply ground. |
| 3 | \overline{CE} or CE | Chip enable pin. |
| 4 | ECO | Mode alternative pin. ($V_{ECO} = V_{in}$ for FT mode; $V_{ECO} = GND$ for LP mode) |
| 5 | V_{out} | Regulated output voltage. |

MAXIMUM RATINGS

| Rating | Symbol | Value | Unit |
|--|--------------------|------------------------|------|
| Input Voltage | V_{in} | 6.5 | V |
| Input Voltage (\overline{CE} or CE Pin) | V_{CE} | -0.3 to $V_{in} + 0.3$ | V |
| Input Voltage (ECO Pin) | V_{ECO} | -0.3 to $V_{in} + 0.3$ | V |
| Output Voltage | V_{out} | -0.3 to $V_{in} + 0.3$ | V |
| Output Current | I_{out} | 250 | mA |
| Power Dissipation | P_D | 250 | mW |
| ESD Capability, Human Body Model, C = 100 pF, R = 1.5 k Ω | ESD _{HBM} | 1000 | V |
| ESD Capability, Machine Model, C = 200 pF, R = 0 Ω | ESD _{MM} | 150 | V |
| Operating Ambient Temperature Range | T_A | -40 to +85 | °C |
| Maximum Junction Temperature | $T_{J(max)}$ | 125 | °C |
| Storage Temperature Range | T_{stg} | -55 to +150 | °C |

Stresses exceeding Maximum Ratings may damage the device. Maximum Ratings are stress ratings only. Functional operation above the Recommended Operating Conditions is not implied. Extended exposure to stresses above the Recommended Operating Conditions may affect device reliability.

NCP584

ELECTRICAL CHARACTERISTICS ($V_{in} = V_{out} + 1.0\text{ V}$, $T_A = 25^\circ\text{C}$, unless otherwise noted.)

| Characteristic | Symbol | Min | Typ | Max | Unit |
|--|----------------------------------|--|------------------------------|--|-----------------------|
| Input Voltage | V_{in} | 1.4 | – | 6.0 | V |
| Output Voltage ($1.0\ \mu\text{A} \leq I_{out} \leq 30\ \text{mA}$) $V_{ECO} = V_{in}$ $V_{ECO} = \text{GND}$ | V_{out} | $V_{out} \times 0.980$ $V_{out} \times 0.970$ | – – | $V_{out} \times 1.020$ $V_{out} \times 1.030$ | V |
| Line Regulation ($I_{out} = 30\ \text{mA}$, $V_{out} + 0.5\ \text{V} \leq V_{in} \leq 6.0\ \text{V}$) FT Mode $V_{ECO} = V_{in}$ LP Mode $V_{ECO} = \text{GND}$ | Reg_{line} | – – | 0.05 0.10 | 0.20 0.30 | %/V |
| Load Regulation FT Mode ($1.0\ \text{mA} \leq I_{out} \leq 200\ \text{mA}$), $V_{ECO} = V_{in}$ LP Mode ($1.0\ \text{mA} \leq I_{out} \leq 100\ \text{mA}$), $V_{ECO} = \text{GND}$ | Reg_{load} | – – | 20 10 | 40 40 | mV |
| Dropout Voltage ($I_{out} = 200\ \text{mA}$) $V_{out} = 0.9\ \text{V}$ $1.2\ \text{V} \leq V_{out} \leq 1.5\ \text{V}$ $1.8\ \text{V} \leq V_{out} \leq 2.5\ \text{V}$ $2.6\ \text{V} \leq V_{out} \leq 3.3\ \text{V}$ | V_{DO} | – – – – | 0.40 0.30 0.20 0.10 | 0.70 0.50 0.30 0.20 | V |
| Quiescent Current ($I_{out} = 0\ \text{mA}$) FT Mode, $V_{ECO} = V_{in}$ LP Mode, $V_{ECO} = \text{GND}$ $V_{out} \leq 1.5\ \text{V}$ $V_{out} \geq 1.8\ \text{V}$ | I_q | – – – | 40 3.5 4.5 | 70 6.0 8.0 | μA |
| Output Current ($V_{in} - V_{out} = 0.5\ \text{V}$) $V_{in} \geq 1.5\ \text{V}$, $V_{out} = 0.9\ \text{V}$ | I_{out} | 200 | – | – | mA |
| Shutdown Current ($V_{CE} = V_{in}$) | I_{SD} | – | 0.1 | 1.0 | μA |
| Output Short Circuit Current ($V_{out} = 0\ \text{V}$) | I_{lim} | – | 50 | – | mA |
| Enable Input Threshold Voltage High Low | $V_{th_{enh}}$ $V_{th_{enl}}$ | 1.0 0 | – – | V_{in} 0.3 | V |
| Ripple Rejection ($I_{out} = 30\ \text{mA}$, $V_{out} = 0.9\ \text{V}$, $V_{in} - V_{out} = 1.0\ \text{V}$) $f = 120\ \text{Hz}$ $f = 1.0\ \text{kHz}$ $f = 10\ \text{kHz}$ | RR | – – – | 75 75 65 | – – – | dB |
| Output Noise Voltage (BW = 10 Hz to 100 kHz) | V_n | – | 30 | – | μV_{rms} |
| Output Voltage Temperature Coefficient ($I_{out} = 30\ \text{mA}$, $-40^\circ\text{C} \leq T_A \leq 85^\circ\text{C}$) | $\Delta V_{out}/\Delta T$ | – | ± 100 | – | ppm/ $^\circ\text{C}$ |

TYPICAL CHARACTERISTICS

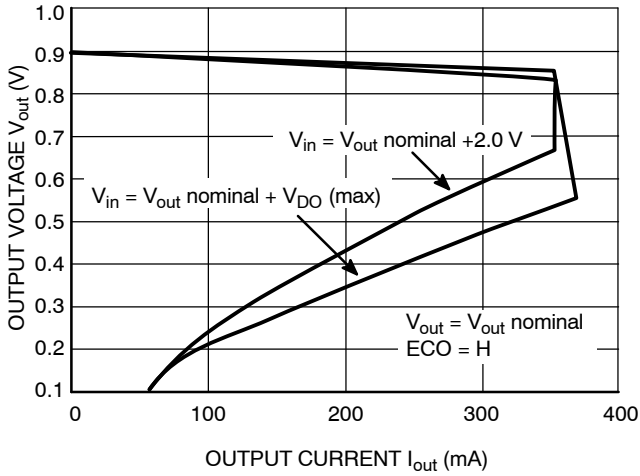

Figure 3. Output Voltage vs. Output Current

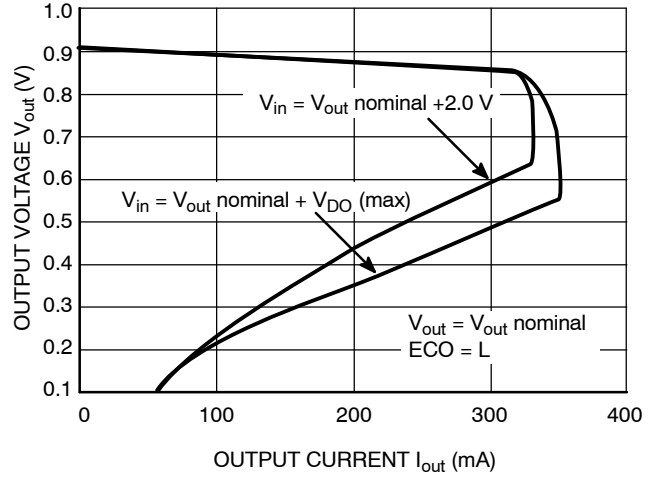

Figure 4. Output Voltage vs. Output Current

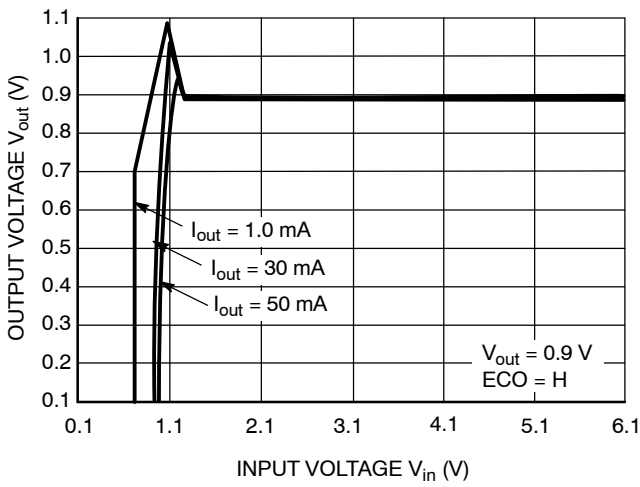

Figure 5. Output Voltage vs. Input Voltage

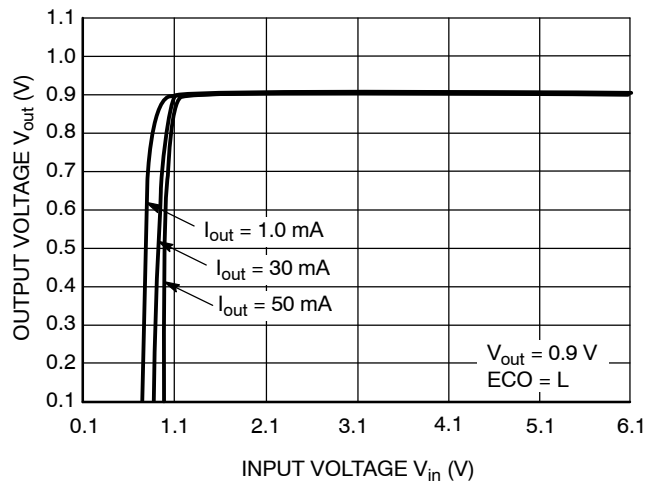

Figure 6. Output Voltage vs. Input Voltage

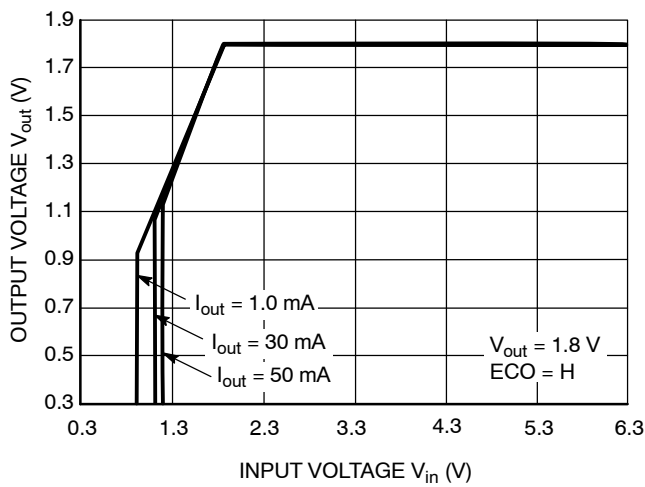

Figure 7. Output Voltage vs. Input Voltage

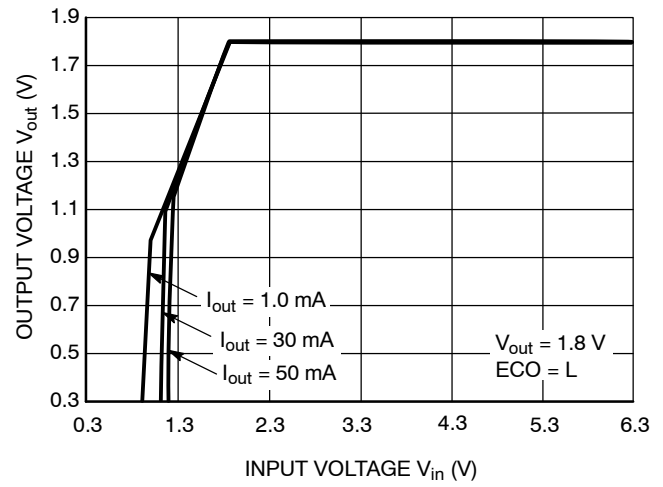

Figure 8. Output Voltage vs. Input Voltage

TYPICAL CHARACTERISTICS

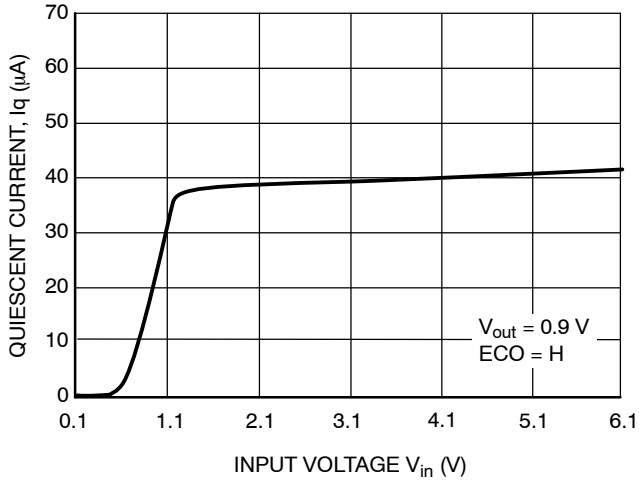

Figure 9. Quiescent Current vs. Input Voltage

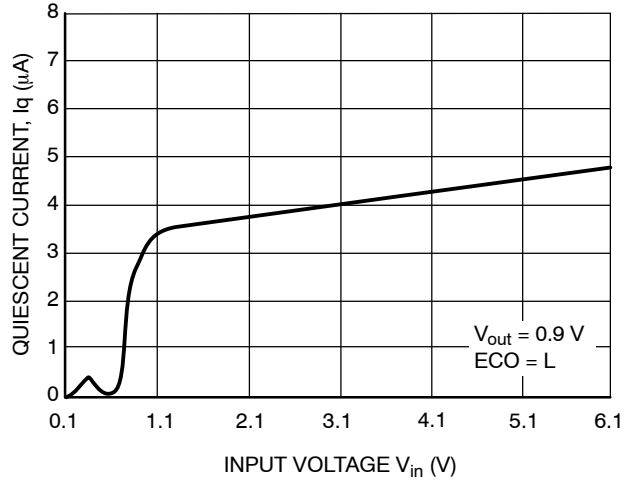

Figure 10. Quiescent Current vs. Input Voltage

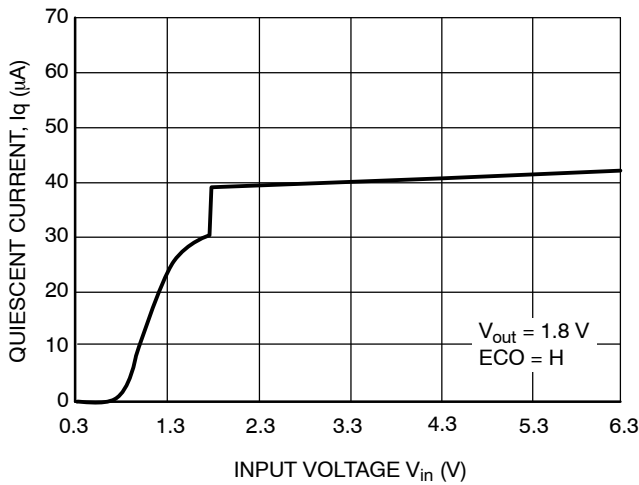

Figure 11. Quiescent Current vs. Input Voltage

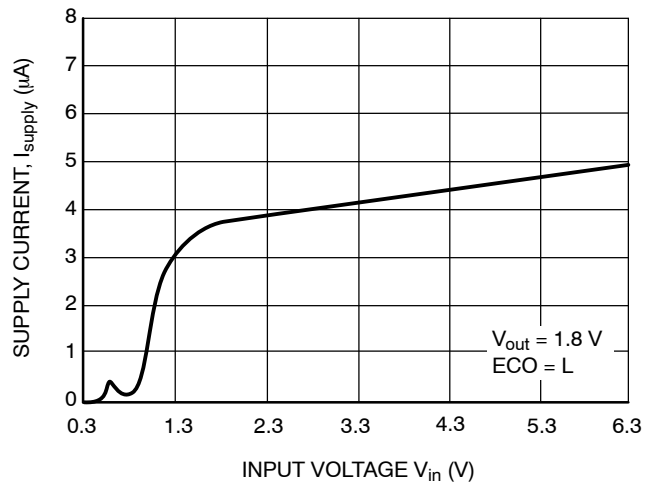

Figure 12. Quiescent Current vs. Input Voltage

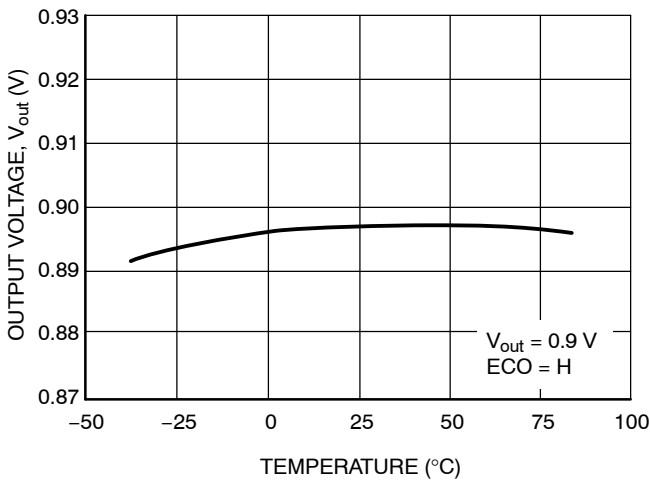

Figure 13. Output Voltage vs. Temperature

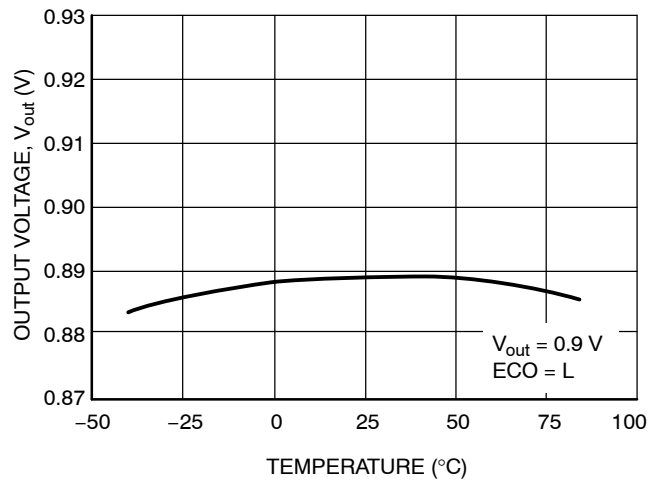

Figure 14. Output Voltage vs. Temperature

TYPICAL CHARACTERISTICS

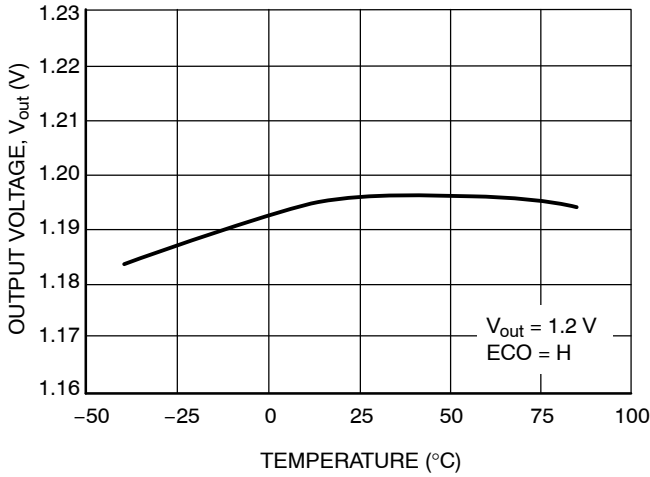

Figure 15. Output Voltage vs. Temperature

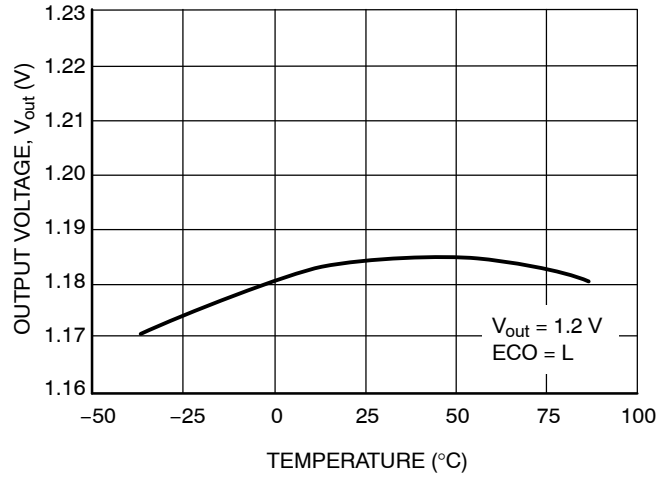

Figure 16. Output Voltage vs. Temperature

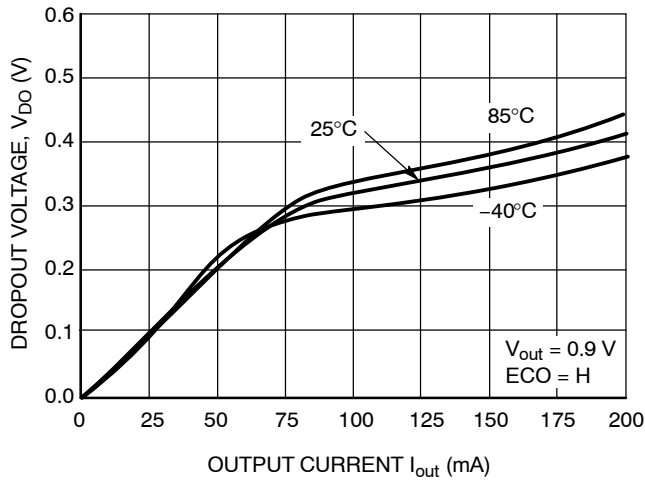

Figure 17. Dropout Voltage vs. Output Current

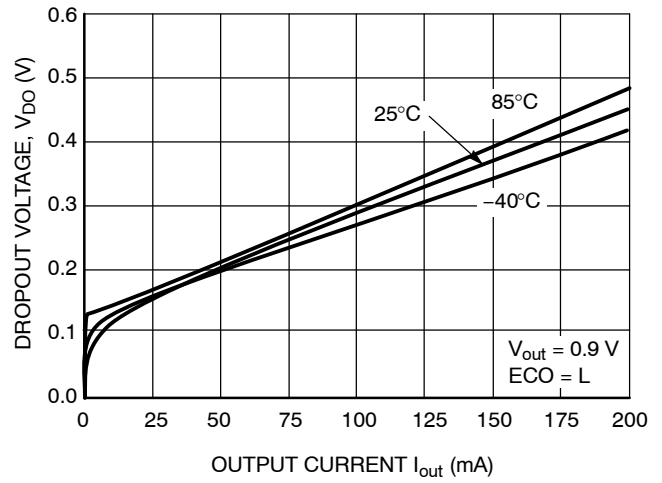

Figure 18. Dropout Voltage vs. Output Current

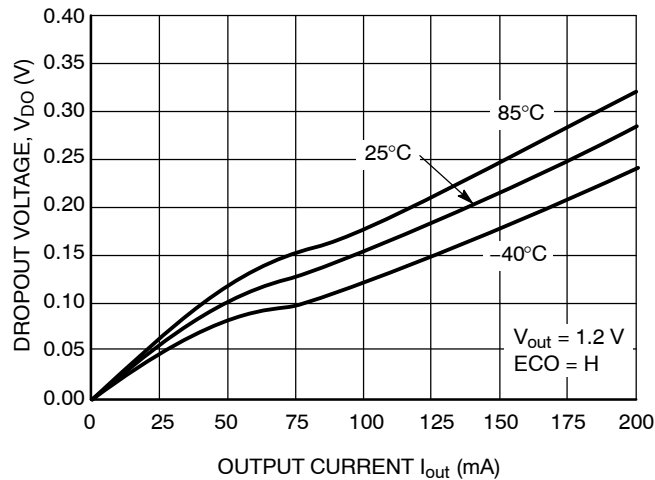

Figure 19. Dropout Voltage vs. Output Current

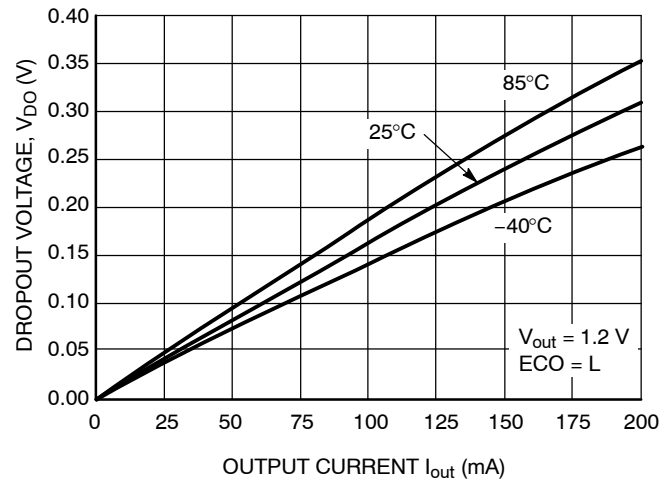

Figure 20. Dropout Voltage vs. Output Current

TYPICAL CHARACTERISTICS

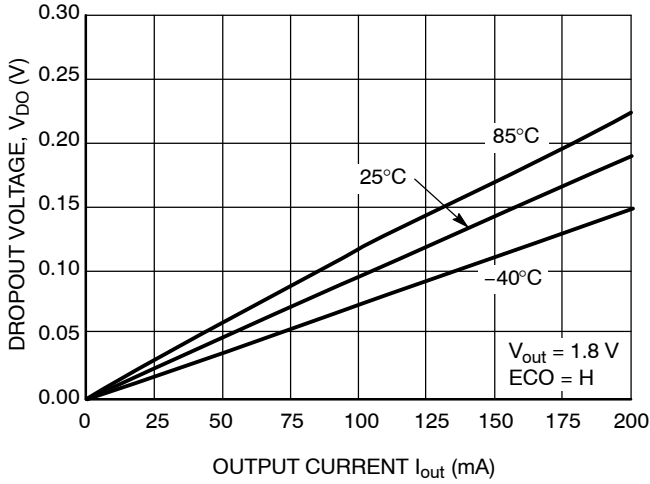

Figure 21. Dropout Voltage vs. Output Current

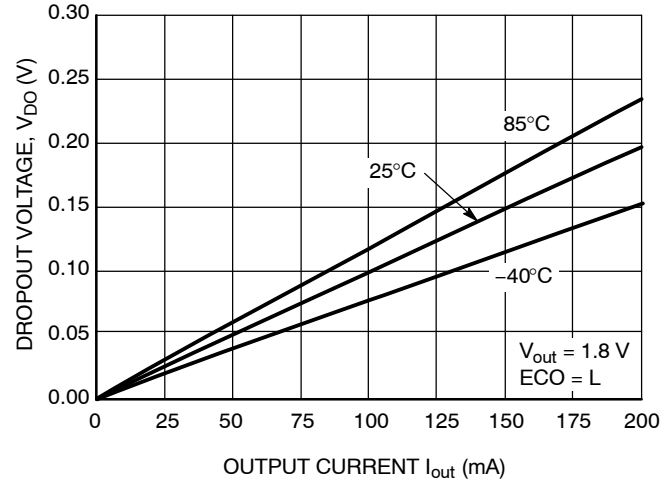

Figure 22. Dropout Voltage vs. Output Current

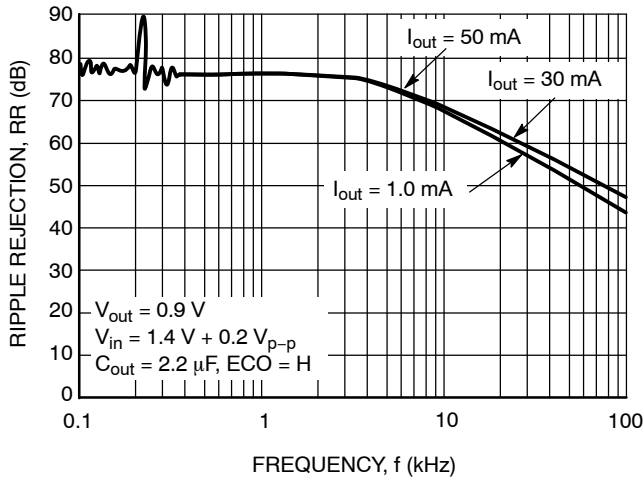

Figure 23. Ripple Rejection vs. Frequency

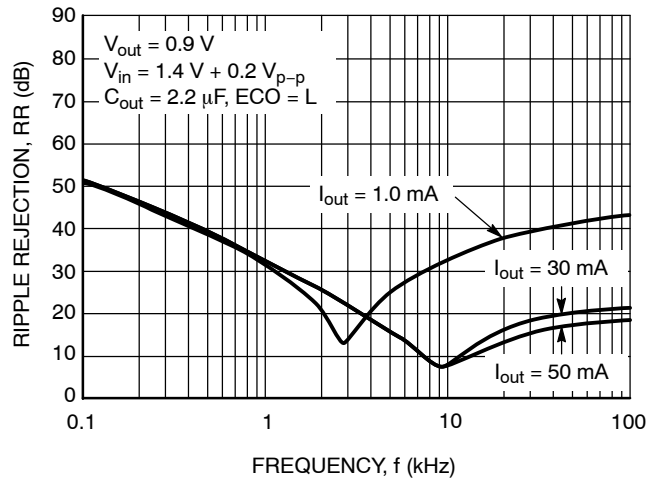

Figure 24. Ripple Rejection vs. Frequency

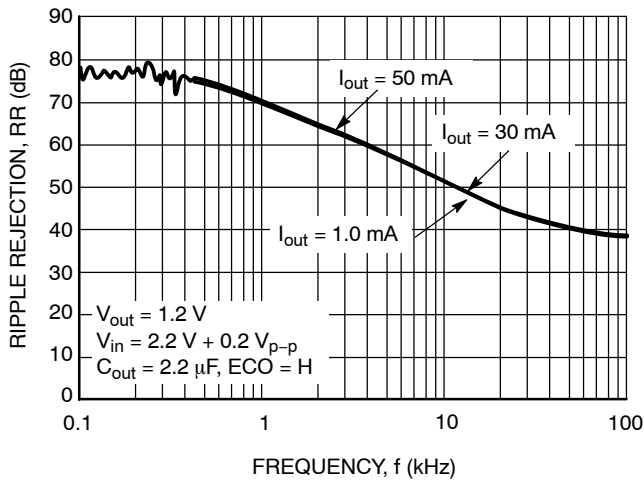

Figure 25. Ripple Rejection vs. Frequency

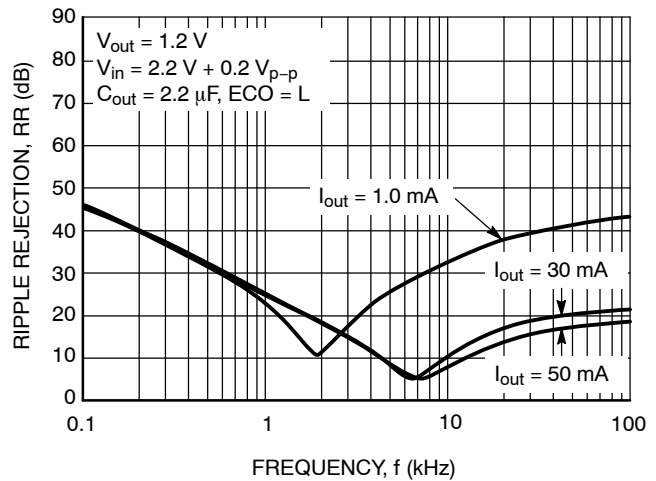

Figure 26. Ripple Rejection vs. Frequency

TYPICAL CHARACTERISTICS

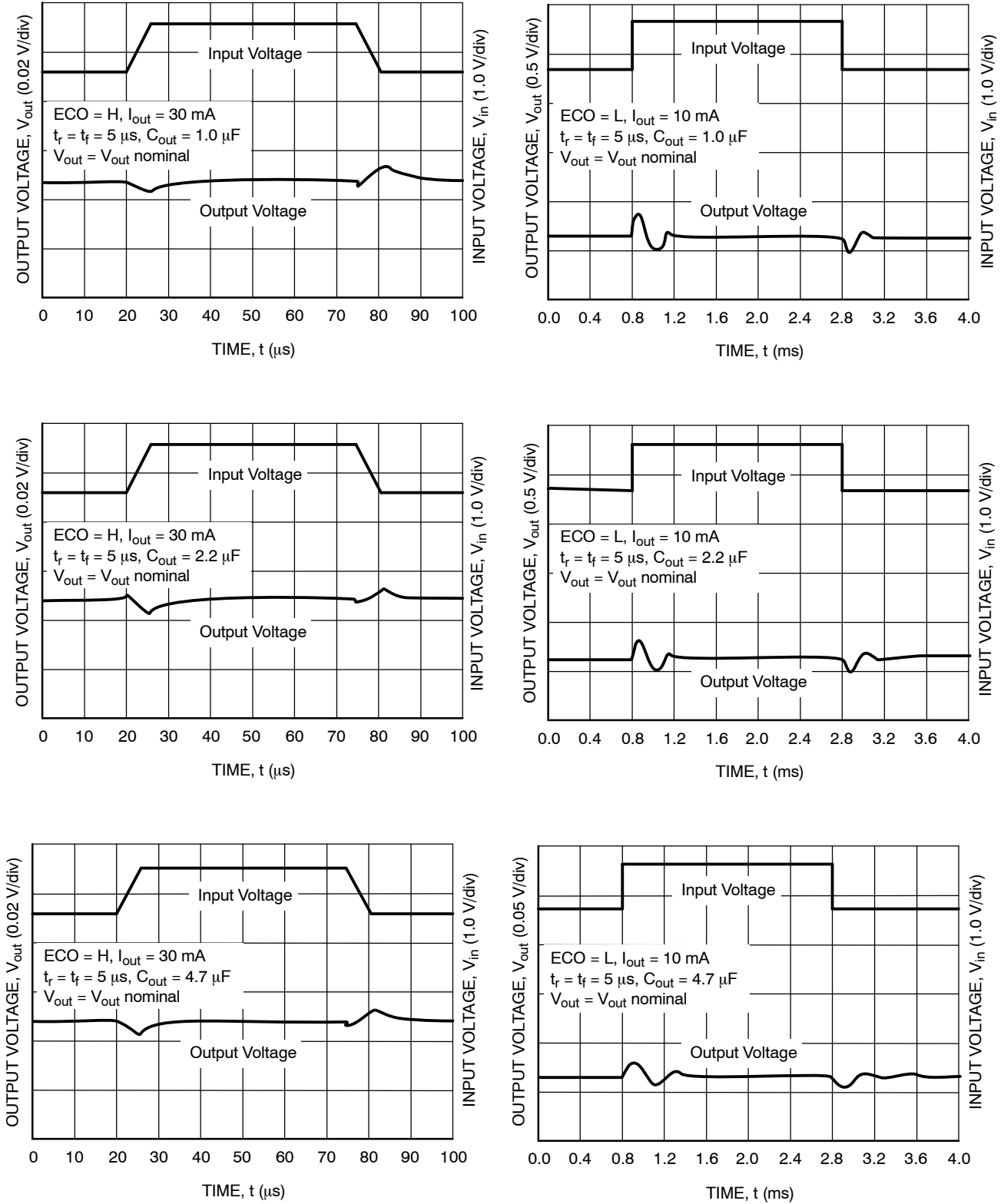

Figure 27. Input Transient Response

TYPICAL CHARACTERISTICS

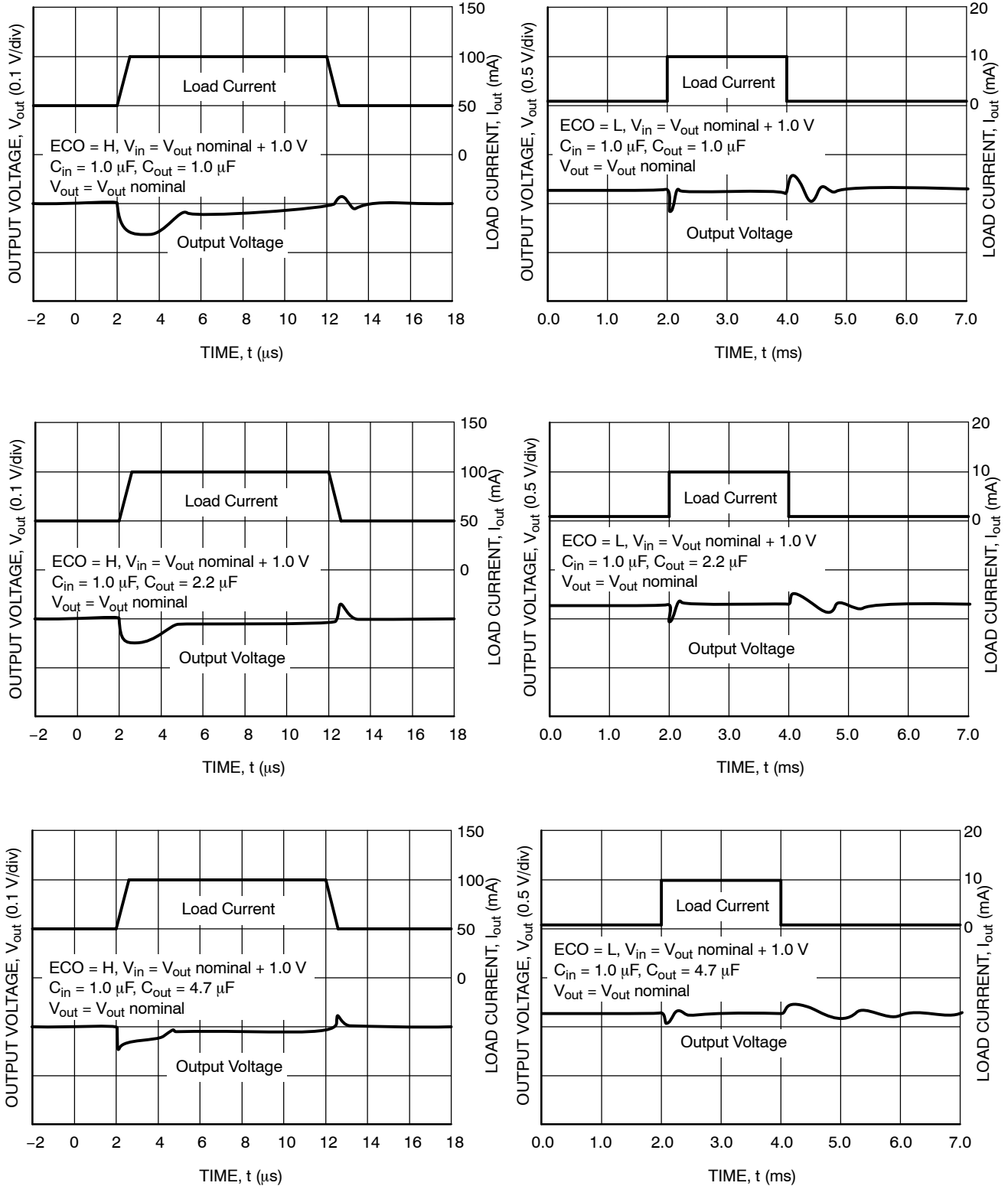

Figure 28. Load Transient Response

TYPICAL CHARACTERISTICS

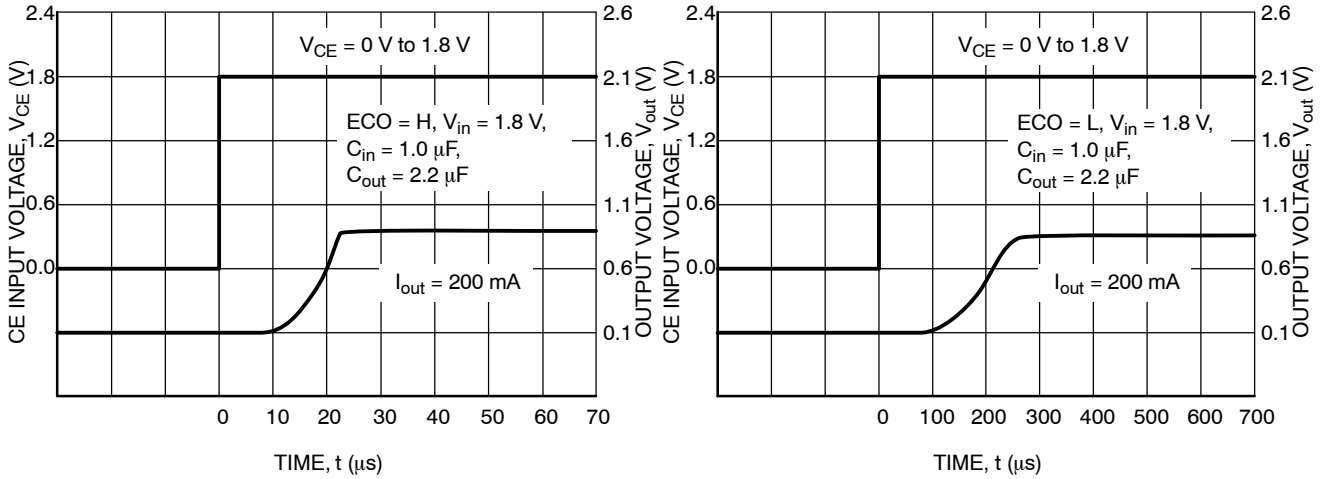

Figure 29. Turn-On/Off Speed with CE Pin ($V_{out} = 0.9$ V)

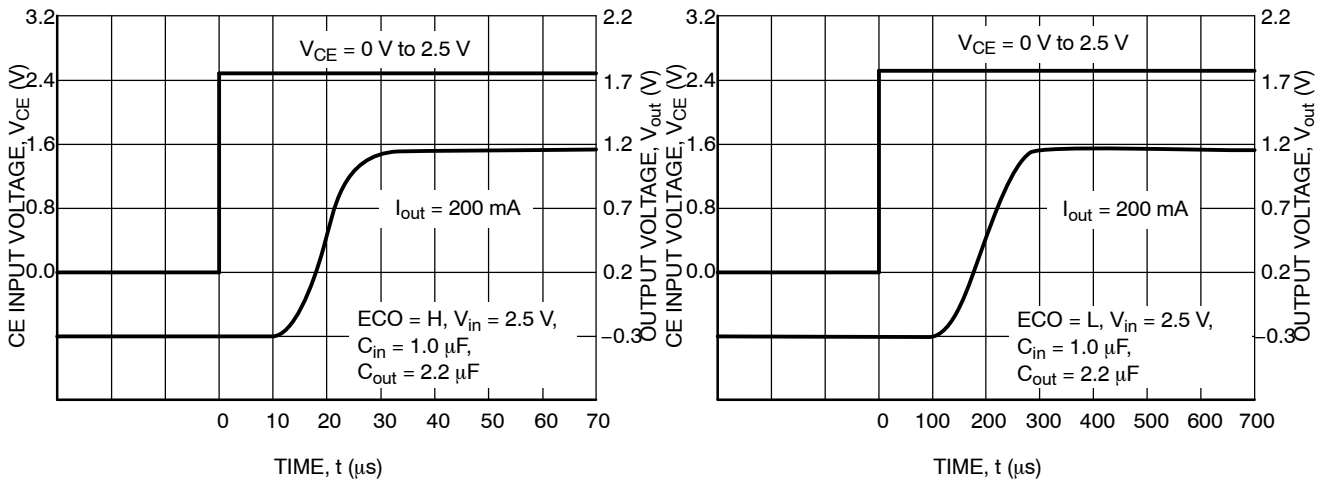

Figure 30. Turn-On/Off Speed with CE Pin ($V_{out} = 1.2$ V)

NCP584

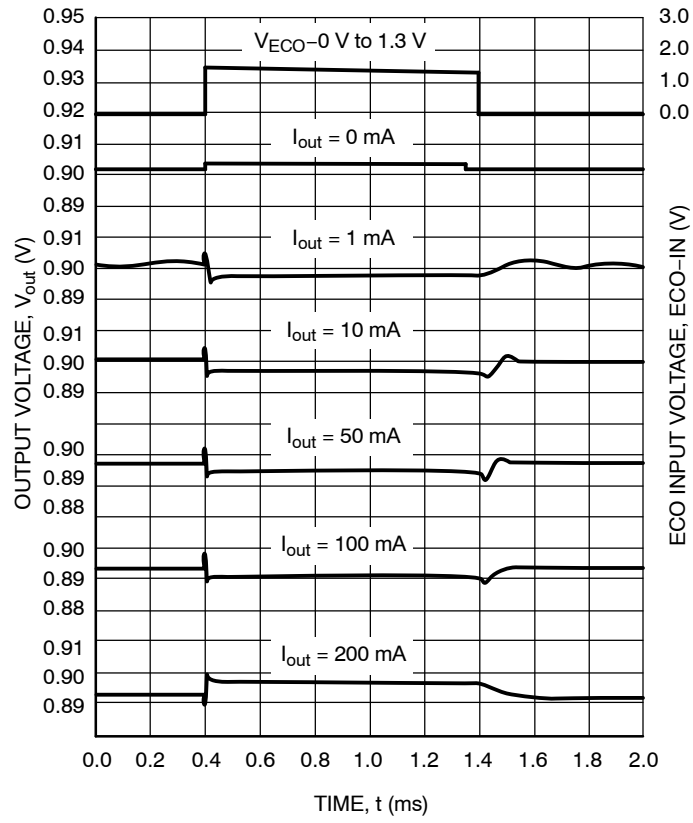

Figure 31. Output Voltage at Mode Alternative Point
($C_{in} = 1.0 \mu F$, $C_{out} = 2.2 \mu F$, 8.0 V, $V_{out} = 0.9$ V)

APPLICATION INFORMATION

Input Decoupling

A 1.0 μF tantalum capacitor is the recommended value to be connected between V_{in} and GND. For PCB layout considerations, the traces of V_{in} and GND should be sufficiently wide in order to minimize noise and prevent unstable operation.

Output Decoupling

It is recommended to use a 2.2 μF or higher tantalum capacitor on the V_{out} pin. For better performance, select a tantalum capacitor with low Equivalent Series Resistance (ESR). If you use a tantalum type capacitor with high ESR

value of this capacitor, output might be unstable. For a ceramic type capacitor it is recommended connection about 1 Ω resistor in series for the stability of output voltage. The relation between Output Current of regulator and ESR of an output capacitor is shown in Figures 32 to 34. Those charts show minimal value of ESR for stable output voltage in Fast Transient mode. The minimal ESR of an output ceramic capacitor in Low Power mode is 40 m Ω for all output voltages. For PCB layout considerations, place the output capacitor close to the output pin and keep the leads short as possible.

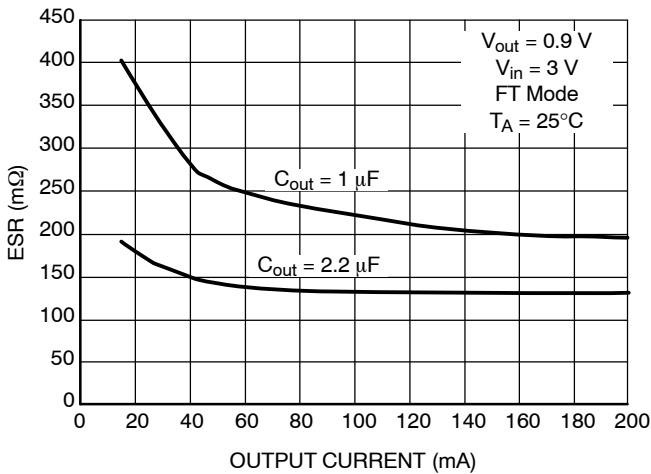

Figure 32. Minimal ESR of Output Ceramic Capacitor vs. Output Current

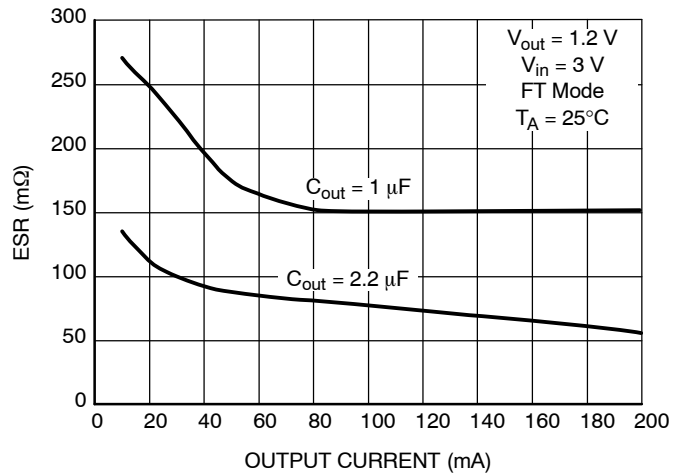

Figure 33. Minimal ESR of Output Ceramic Capacitor vs. Output Current

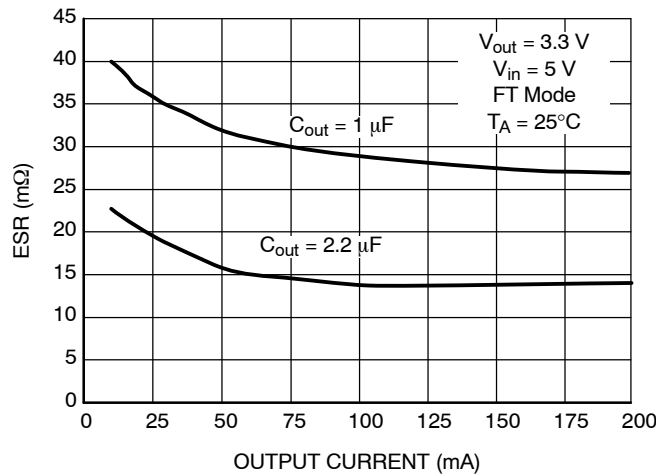

Figure 34. Minimal ESR of Output Ceramic Capacitor vs. Output Current

NCP584

ORDERING INFORMATION

| Device | Output Type / Features | Nominal Output Voltage | Marking | Package | Shipping [†] |
|----------------|--------------------------------|------------------------|---------|----------------------|-----------------------|
| NCP584HSN09T1G | Active High, LP and FT Mode | 0.9 | 109 | SOT23-5 (Pb-Free) | 3000 / Tape & Reel |
| NCP584HSN12T1G | Active High, LP and FT Mode | 1.2 | 112 | SOT23-5 (Pb-Free) | 3000 / Tape & Reel |
| NCP584HSN15T1G | Active High, LP and FT Mode | 1.5 | 115 | SOT23-5 (Pb-Free) | 3000 / Tape & Reel |
| NCP584HSN18T1G | Active High, LP and FT Mode | 1.8 | 118 | SOT23-5 (Pb-Free) | 3000 / Tape & Reel |
| NCP584HSN25T1G | Active High, LP and FT Mode | 2.5 | 125 | SOT23-5 (Pb-Free) | 3000 / Tape & Reel |
| NCP584HSN26T1G | Active High, LP and FT Mode | 2.6 | 126 | SOT23-5 (Pb-Free) | 3000 / Tape & Reel |
| NCP584HSN28T1G | Active High, LP and FT Mode | 2.8 | 128 | SOT23-5 (Pb-Free) | 3000 / Tape & Reel |
| NCP584HSN30T1G | Active High, LP and FT Mode | 3.0 | 130 | SOT23-5 (Pb-Free) | 3000 / Tape & Reel |
| NCP584HSN31T1G | Active High, LP and FT Mode | 3.1 | 131 | SOT23-5 (Pb-Free) | 3000 / Tape & Reel |
| NCP584HSN33T1G | Active High, LP and FT Mode | 3.3 | 133 | SOT23-5 (Pb-Free) | 3000 / Tape & Reel |
| NCP584LSN09T1G | Active Low, LP and FT Mode | 0.9 | 009 | SOT23-5 (Pb-Free) | 3000 / Tape & Reel |
| NCP584LSN12T1G | Active Low, LP and FT Mode | 1.2 | 012 | SOT23-5 (Pb-Free) | 3000 / Tape & Reel |
| NCP584LSN18T1G | Active Low, LP and FT Mode | 1.8 | 018 | SOT23-5 (Pb-Free) | 3000 / Tape & Reel |

[†]For information on tape and reel specifications, including part orientation and tape sizes, please refer to our Tape and Reel Packaging Specification Brochure, BRD8011/D.

Other voltages are available. Consult your ON Semiconductor representative.

NCP584

PACKAGE DIMENSIONS

SOT23-5
SN SUFFIX
CASE 1212-01
ISSUE O

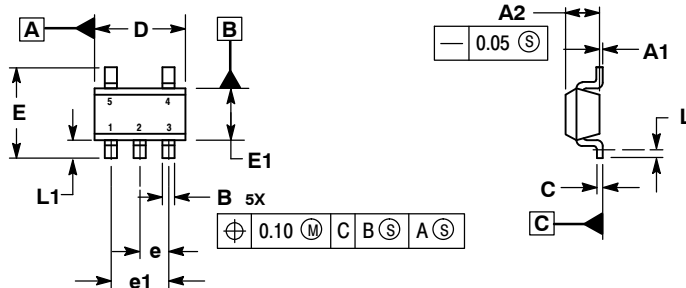

NOTES:

1. DIMENSIONS ARE IN MILLIMETERS.
2. INTERPRET DIMENSIONS AND TOLERANCES PER ASME Y14.5M, 1994.
3. DATUM C IS A SEATING PLANE.

| MILLIMETERS | | |
|-------------|----------|------|
| DIM | MIN | MAX |
| A1 | 0.00 | 0.10 |
| A2 | 1.00 | 1.30 |
| B | 0.30 | 0.50 |
| C | 0.10 | 0.25 |
| D | 2.80 | 3.00 |
| E | 2.50 | 3.10 |
| E1 | 1.50 | 1.80 |
| e | 0.95 BSC | |
| e1 | 1.90 BSC | |
| L | 0.20 | --- |
| L1 | 0.45 | 0.75 |

SOLDERING FOOTPRINT*

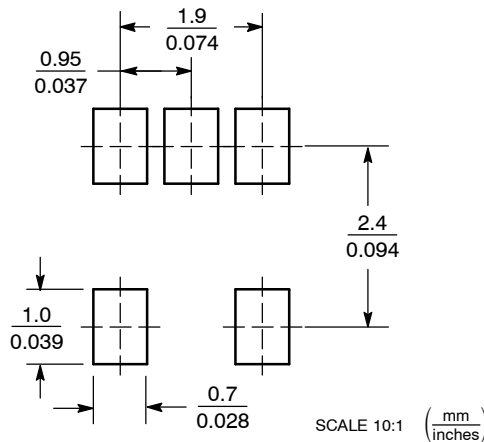

*For additional information on our Pb-Free strategy and soldering details, please download the ON Semiconductor Soldering and Mounting Techniques Reference Manual, SOLDERRM/D.

ON Semiconductor and are registered trademarks of Semiconductor Components Industries, LLC (SCILLC). SCILLC reserves the right to make changes without further notice to any products herein. SCILLC makes no warranty, representation or guarantee regarding the suitability of its products for any particular purpose, nor does SCILLC assume any liability arising out of the application or use of any product or circuit, and specifically disclaims any and all liability, including without limitation special, consequential or incidental damages. "Typical" parameters which may be provided in SCILLC data sheets and/or specifications can and do vary in different applications and actual performance may vary over time. All operating parameters, including "Typicals" must be validated for each customer application by customer's technical experts. SCILLC does not convey any license under its patent rights nor the rights of others. SCILLC products are not designed, intended, or authorized for use as components in systems intended for surgical implant into the body, or other applications intended to support or sustain life, or for any other application in which the failure of the SCILLC product could create a situation where personal injury or death may occur. Should Buyer purchase or use SCILLC products for any such unintended or unauthorized application, Buyer shall indemnify and hold SCILLC and its officers, employees, subsidiaries, affiliates, and distributors harmless against all claims, costs, damages, and expenses, and reasonable attorney fees arising out of, directly or indirectly, any claim of personal injury or death associated with such unintended or unauthorized use, even if such claim alleges that SCILLC was negligent regarding the design or manufacture of the part. SCILLC is an Equal Opportunity/Affirmative Action Employer. This literature is subject to all applicable copyright laws and is not for resale in any manner.

PUBLICATION ORDERING INFORMATION

LITERATURE FULFILLMENT:
Literature Distribution Center for ON Semiconductor
P.O. Box 5163, Denver, Colorado 80217 USA
Phone: 303-675-2175 or 800-344-3860 Toll Free USA/Canada
Fax: 303-675-2176 or 800-344-3867 Toll Free USA/Canada
Email: orderlit@onsemi.com

N. American Technical Support: 800-282-9855 Toll Free
USA/Canada
Europe, Middle East and Africa Technical Support:
Phone: 421 33 790 2910
Japan Customer Focus Center
Phone: 81-3-5773-3850

ON Semiconductor Website: www.onsemi.com
Order Literature: <http://www.onsemi.com/orderlit>

For additional information, please contact your local Sales Representative

Looking for pricing, stock, or lifecycle information?

Click below to explore more details on WIN SOURCE:

 [View NCP584HSN28T1G on WIN SOURCE](#)

 [ON Semiconductor](#) Information

Optimize Your Supply Chain with WIN SOURCE Solutions

-  Global Sourcing Solution
-  Obsolete Management
-  Cost Control Management
-  Shortage Management
-  Alternative Solution
-  Excess Inventory Management