



THE DATASHEET OF STD35P6LLF6



P-channel 60 V, 0.025 Ω typ., 35 A STripFET™ F6 Power MOSFET in a DPAK package

Datasheet - production data

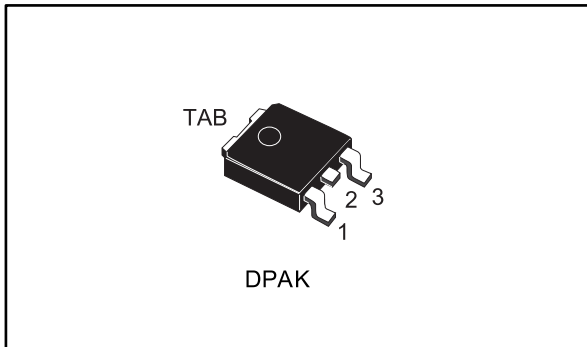
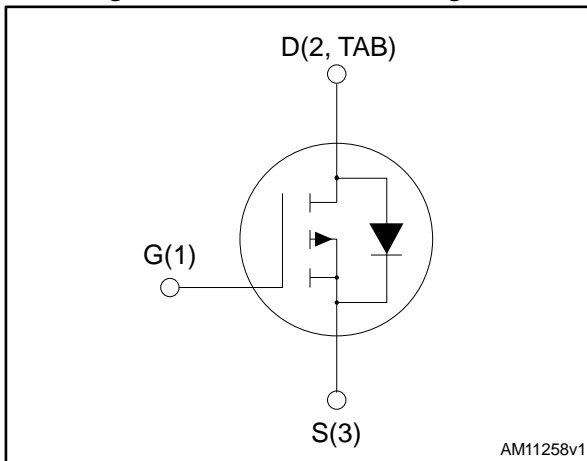

Figure 1: Internal schematic diagram



Features

Order code	V _{DSS}	R _{DS(on)} max.	I _D	P _{TOT}
STD35P6LLF6	60 V	0.028 Ω	35 A	70 W

- Very low on-resistance
- Very low gate charge
- High avalanche ruggedness
- Low gate drive power loss

Applications

- Switching applications

Description

This device is a P-channel Power MOSFET developed using the STripFET™ F6 technology, with a new trench gate structure. The resulting Power MOSFET exhibits very low R_{DS(on)} in all packages.

Table 1: Device summary

Order code	Marking	Package	Packaging
STD35P6LLF6	35P6LLF6	DPAK	Tape and Reel

Contents

1	Electrical ratings	3
2	Electrical characteristics	4
	2.1 Electrical characteristics (curves)	6
3	Test circuits	8
4	Package information	9
	4.1 DPAK package information	10
	4.2 Packing information.....	13
5	Revision history	15

1 Electrical ratings

Table 2: Absolute maximum ratings

Symbol	Parameter	Value	Unit
V_{DS}	Drain-source voltage	60	V
V_{GS}	Gate-source voltage	± 20	V
I_D	Drain current (continuous) at $T_C = 25\text{ }^\circ\text{C}$	35	A
I_D	Drain current (continuous) at $T_C = 100\text{ }^\circ\text{C}$	25	A
$I_{DM}^{(1)}$	Drain current (pulsed)	140	A
P_{TOT}	Total dissipation at $T_C = 25\text{ }^\circ\text{C}$	70	W
T_{stg}	Storage temperature range	-55 to 175	$^\circ\text{C}$
T_j	Operating junction temperature range		

Notes:

⁽¹⁾Pulse width limited by safe operating area.

Table 3: Thermal data

Symbol	Parameter	Value	Unit
$R_{thj-case}$	Thermal resistance junction-case max	2.14	$^\circ\text{C/W}$



For the P-channel Power MOSFET, current polarity of voltages and current have to be reversed.

2 Electrical characteristics

($T_C = 25\text{ °C}$ unless otherwise specified)

Table 4: Static

Symbol	Parameter	Test conditions	Min.	Typ.	Max.	Unit
$V_{(BR)DSS}$	Drain-source breakdown voltage	$V_{GS} = 0\text{ V}$, $I_D = 250\text{ }\mu\text{A}$	60			V
I_{DSS}	Zero gate voltage Drain current	$V_{GS} = 0\text{ V}$, $V_{DS} = 60\text{ V}$			1	μA
		$V_{GS} = 0\text{ V}$, $V_{DS} = 60\text{ V}$, $T_C = 125\text{ °C}^{(1)}$			10	μA
I_{GSS}	Gate-body leakage current	$V_{DS} = 0\text{ V}$, $V_{GS} = \pm 20\text{ V}$			± 100	nA
$V_{GS(th)}$	Gate threshold voltage	$V_{DS} = V_{GS}$, $I_D = 250\text{ }\mu\text{A}$	1		2.5	V
$R_{DS(on)}$	Static drain-source on-resistance	$V_{GS} = 10\text{ V}$, $I_D = 17.5\text{ A}$		0.025	0.028	Ω
		$V_{GS} = 4.5\text{ V}$, $I_D = 17.5\text{ A}$		0.03	0.036	

Notes:

⁽¹⁾Defined by design, not subject to production test.

Table 5: Dynamic

Symbol	Parameter	Test conditions	Min.	Typ.	Max.	Unit
C_{iss}	Input capacitance	$V_{DS} = 25\text{ V}$, $f = 1\text{ MHz}$, $V_{GS} = 0\text{ V}$	-	3780	-	pF
C_{oss}	Output capacitance		-	262	-	pF
C_{rss}	Reverse transfer capacitance		-	170	-	pF
Q_g	Total gate charge	$V_{DD} = 30\text{ V}$, $I_D = 35\text{ A}$, $V_{GS} = 0\text{ to }4.5\text{ V}$ (see Figure 14: "Gate charge test circuit")	-	30	-	nC
Q_{gs}	Gate-source charge		-	10.8	-	nC
Q_{gd}	Gate-drain charge		-	10.5	-	nC
R_G	Gate input resistance	$I_D = 0\text{ A}$, gate DC bias = 0 V , $f = 1\text{ MHz}$, magnitude of alternative signal = 20 mV	-	1.7	-	Ω

Table 6: Switching times

Symbol	Parameter	Test conditions	Min.	Typ.	Max.	Unit
$t_{d(on)}$	Turn-on delay time	$V_{DD} = 30\text{ V}$, $I_D = 17.5\text{ A}$ $R_G = 4.7\text{ }\Omega$, $V_{GS} = 10\text{ V}$ (see Figure 13: "Switching times test circuit for resistive load")	-	51.4	-	ns
t_r	Rise time		-	39	-	ns
$t_{d(off)}$	Turn-off-delay time		-	171	-	ns
t_f	Fall time		-	21	-	ns



For the P-channel Power MOSFET, current polarity of voltages and current have to be reversed.

Table 7: Source drain diode

Symbol	Parameter	Test conditions	Min.	Typ.	Max.	Unit
$V_{SD}^{(1)}$	Forward on voltage	$V_{GS} = 0\text{ V}$, $I_{SD} = 35\text{ A}$	-		1.5	V
t_{rr}	Reverse recovery time	$I_{SD} = 35\text{ A}$, $di/dt = 100\text{ A}/\mu\text{s}$, $V_{DD} = 48\text{ V}$, (see Figure 15 : "Test circuit for inductive load switching and diode recovery times")	-	34		ns
Q_{rr}	Reverse recovery charge		-	48		nC
I_{RRM}	Reverse recovery current		-	2.8		A

Notes:

⁽¹⁾Pulse test: pulse duration = 300 μs , duty cycle 1.5%



For the P-channel Power MOSFET, current polarity of voltages and current have to be reversed.

2.1 Electrical characteristics (curves)

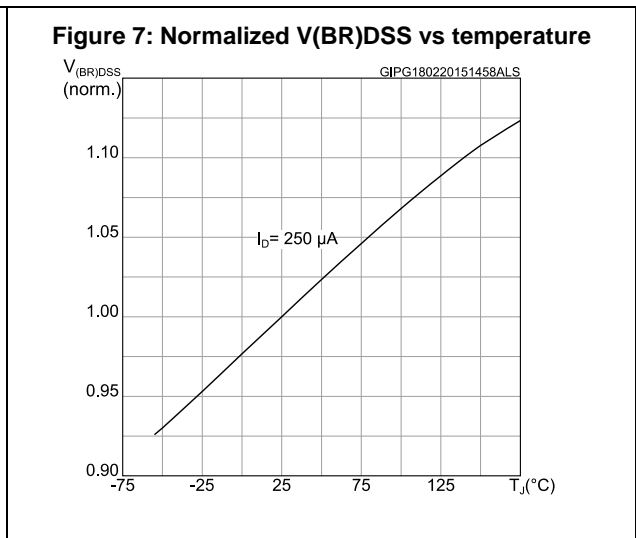
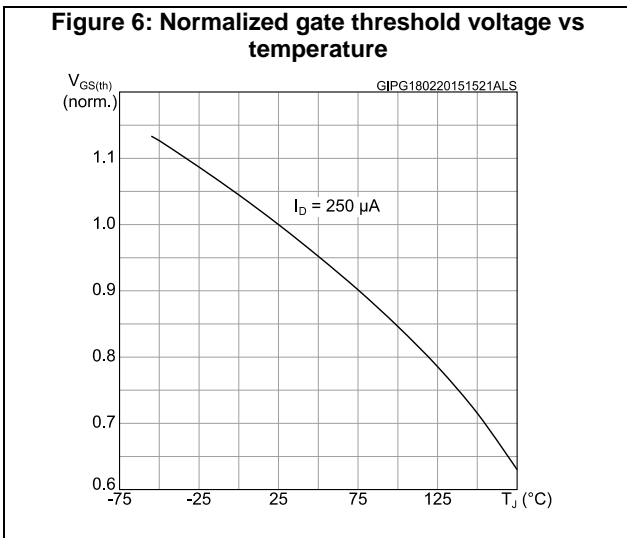
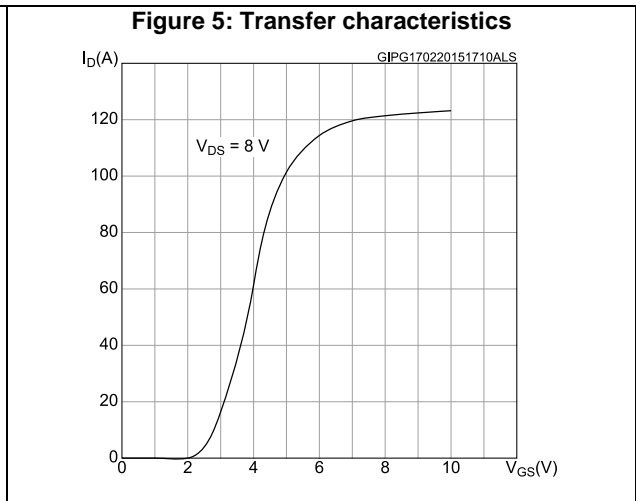
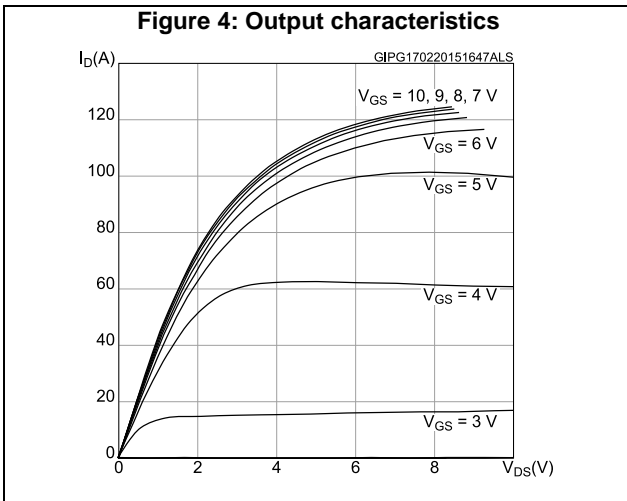
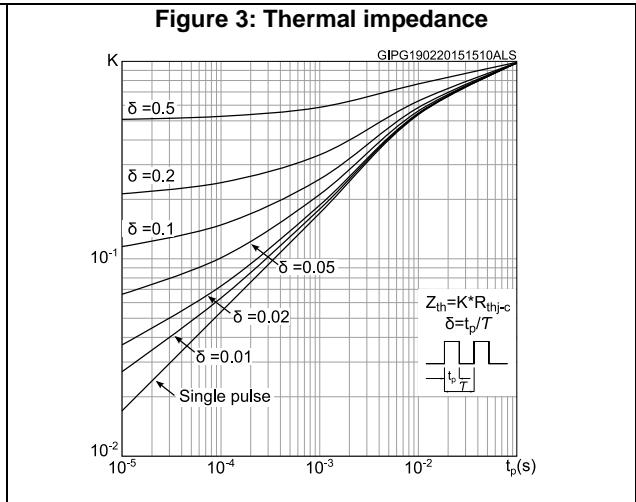
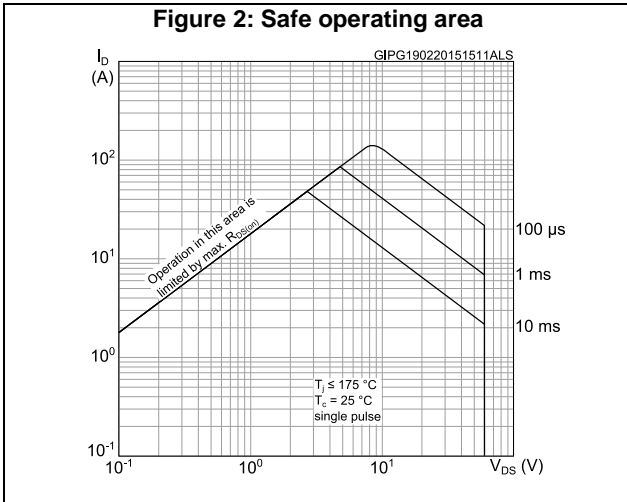

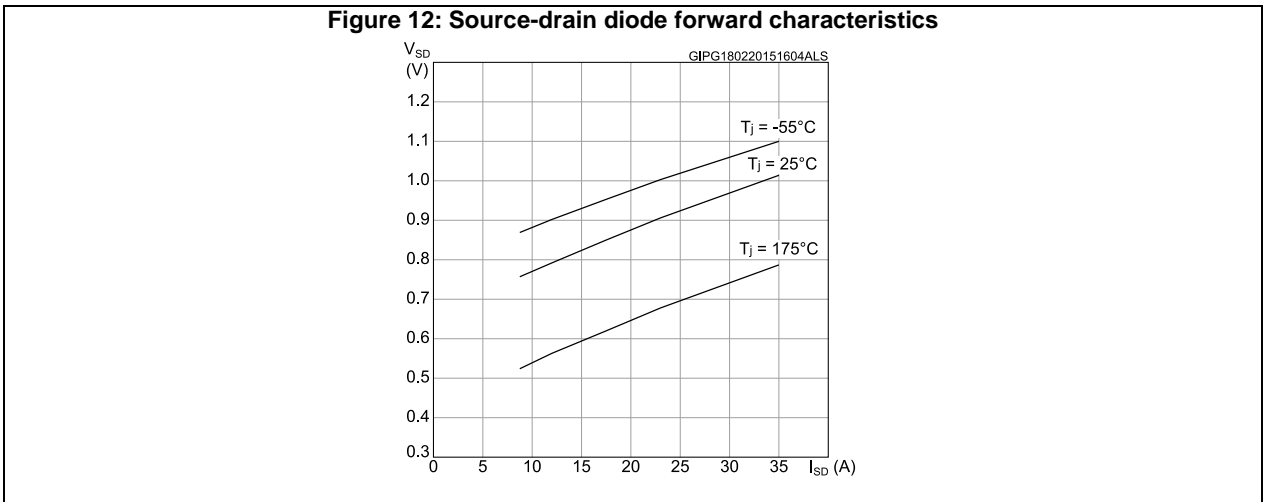
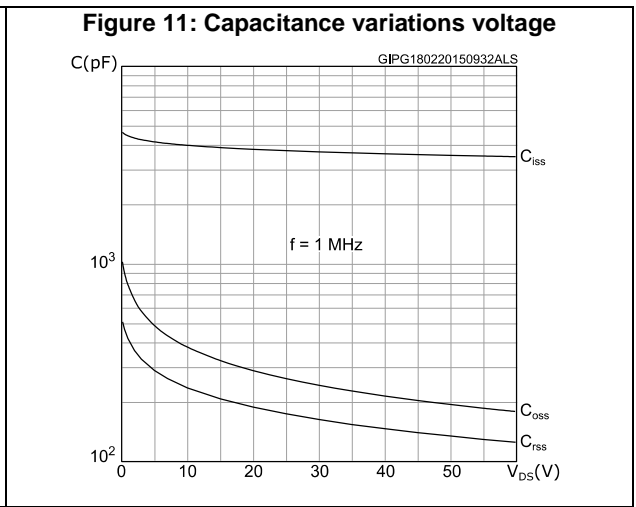
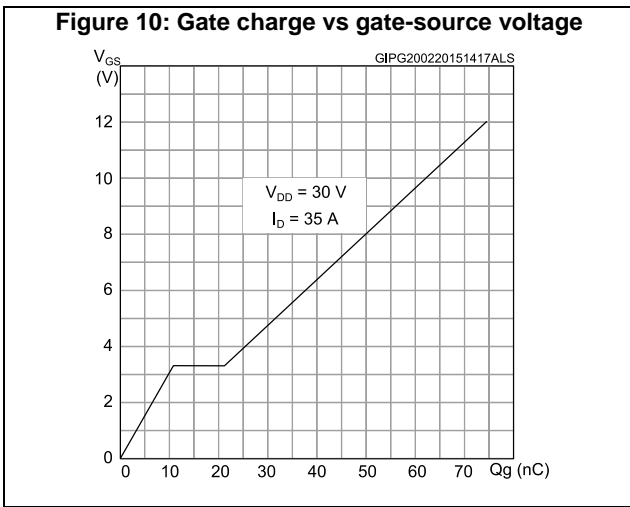
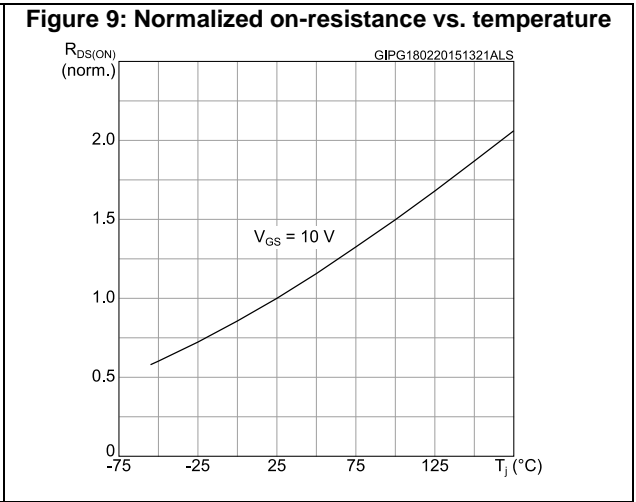
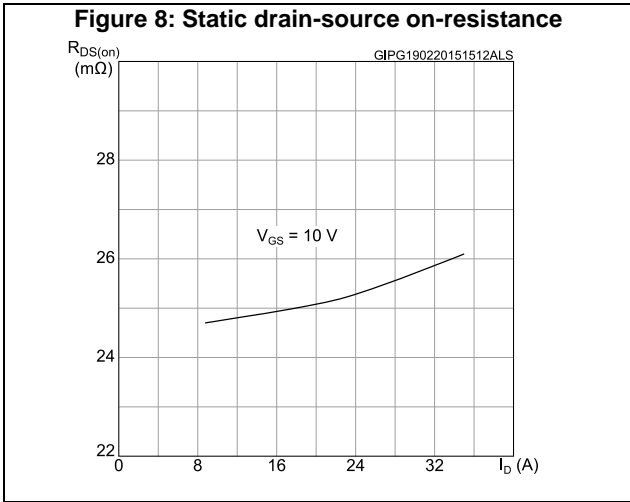

3 Test circuits

Figure 13: Switching times test circuit for resistive load

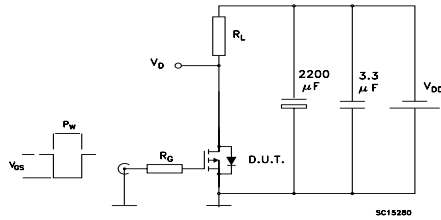

Figure 14: Gate charge test circuit

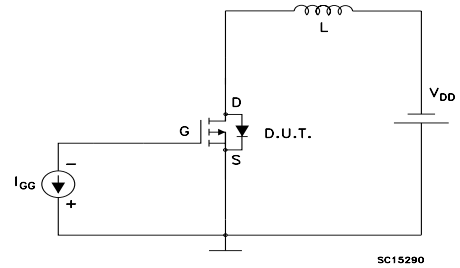
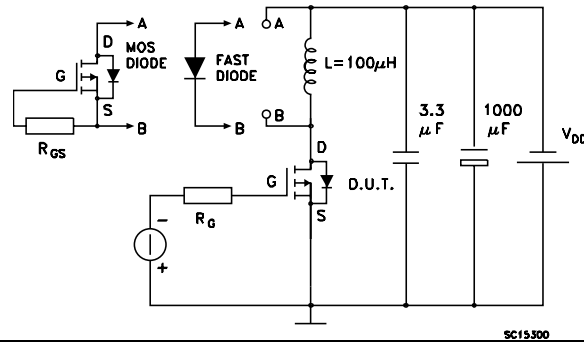

Figure 15: Test circuit for inductive load switching and diode recovery times



4 Package information

In order to meet environmental requirements, ST offers these devices in different grades of ECOPACK® packages, depending on their level of environmental compliance. ECOPACK® specifications, grade definitions and product status are available at: www.st.com. ECOPACK® is an ST trademark.

4.1 DPAK package information

Figure 16: DPAK (TO-252) type A2 package outline

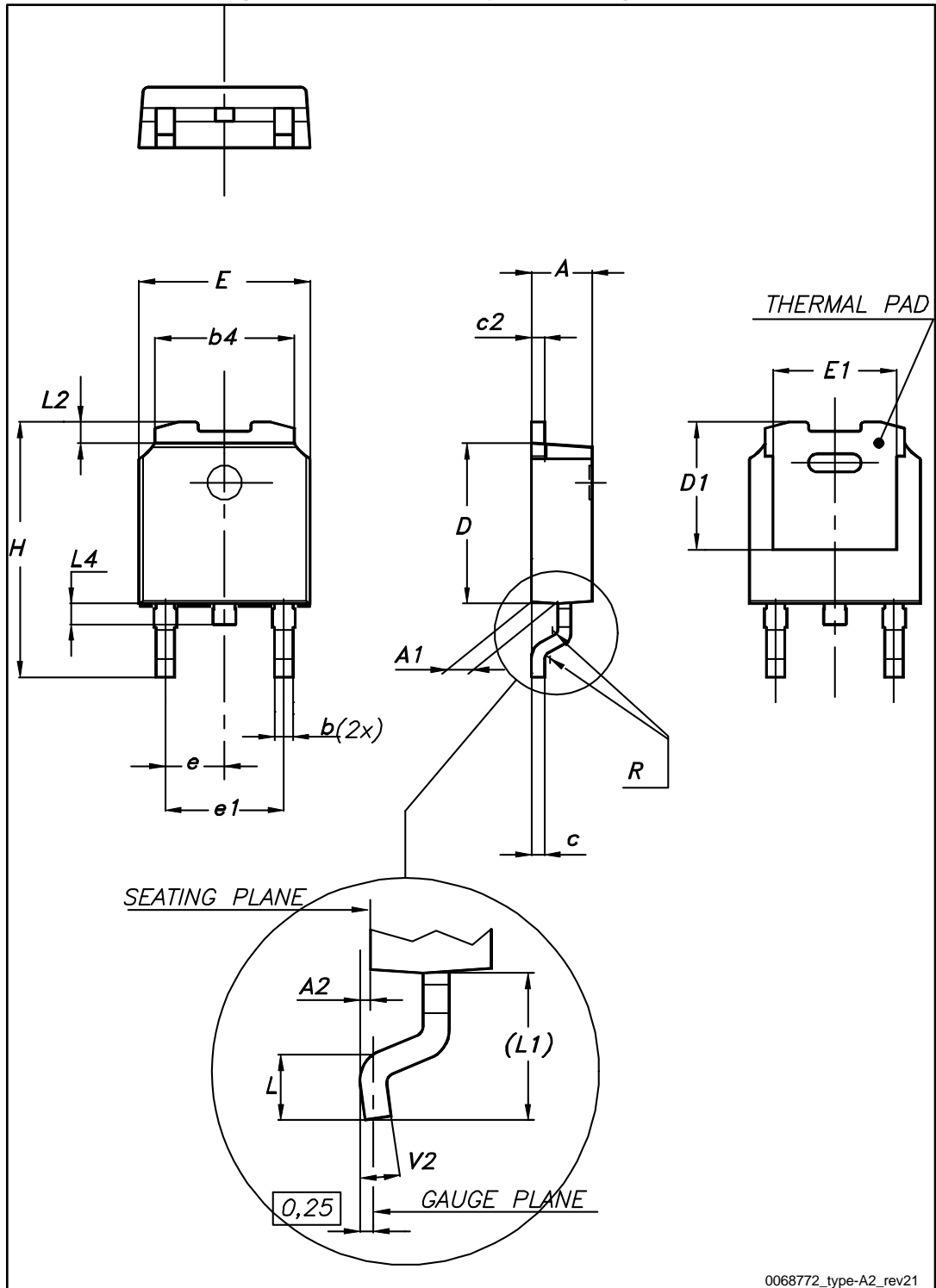
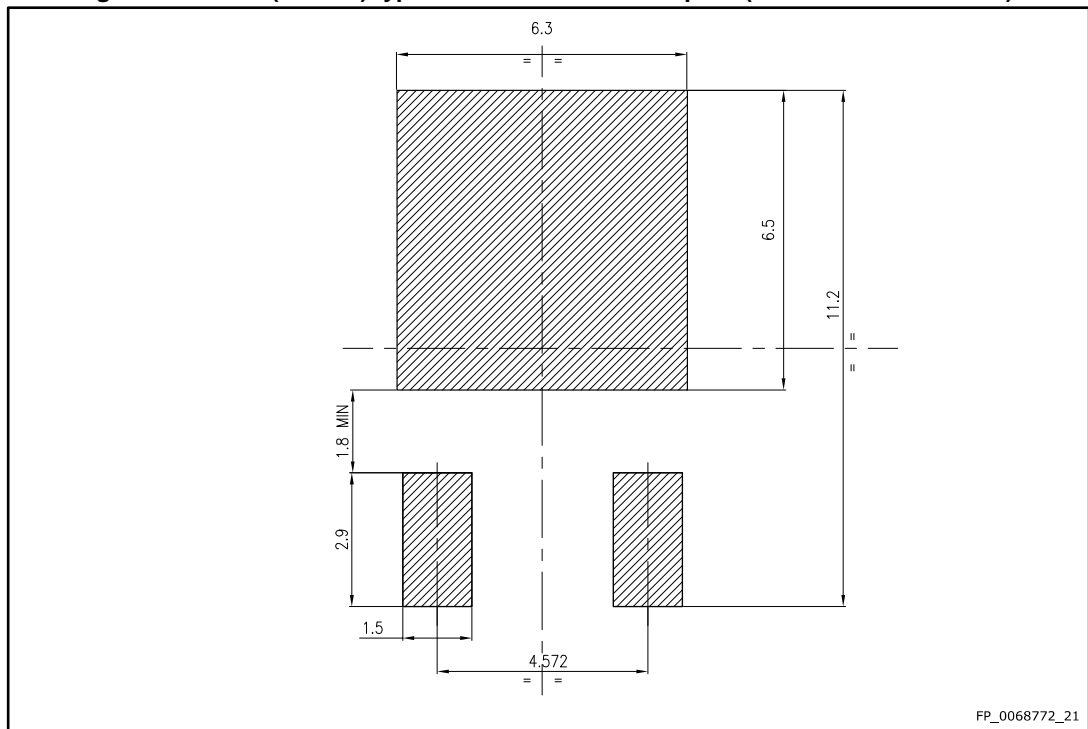

Table 8: DPAK (TO-252) type A2 mechanical data

Dim.	mm		
	Min.	Typ.	Max.
A	2.20		2.40
A1	0.90		1.10
A2	0.03		0.23
b	0.64		0.90
b4	5.20		5.40
c	0.45		0.60
c2	0.48		0.60
D	6.00		6.20
D1	4.95	5.10	5.25
E	6.40		6.60
E1	5.10	5.20	5.30
e	2.16	2.28	2.40
e1	4.40		4.60
H	9.35		10.10
L	1.00		1.50
L1	2.60	2.80	3.00
L2	0.65	0.80	0.95
L4	0.60		1.00
R		0.20	
V2	0°		8°

Figure 17: DPAK (TO-252) type A2 recommended footprint (dimensions are in mm)



4.2 Packing information

Figure 18: DPAK (TO-252) tape outline

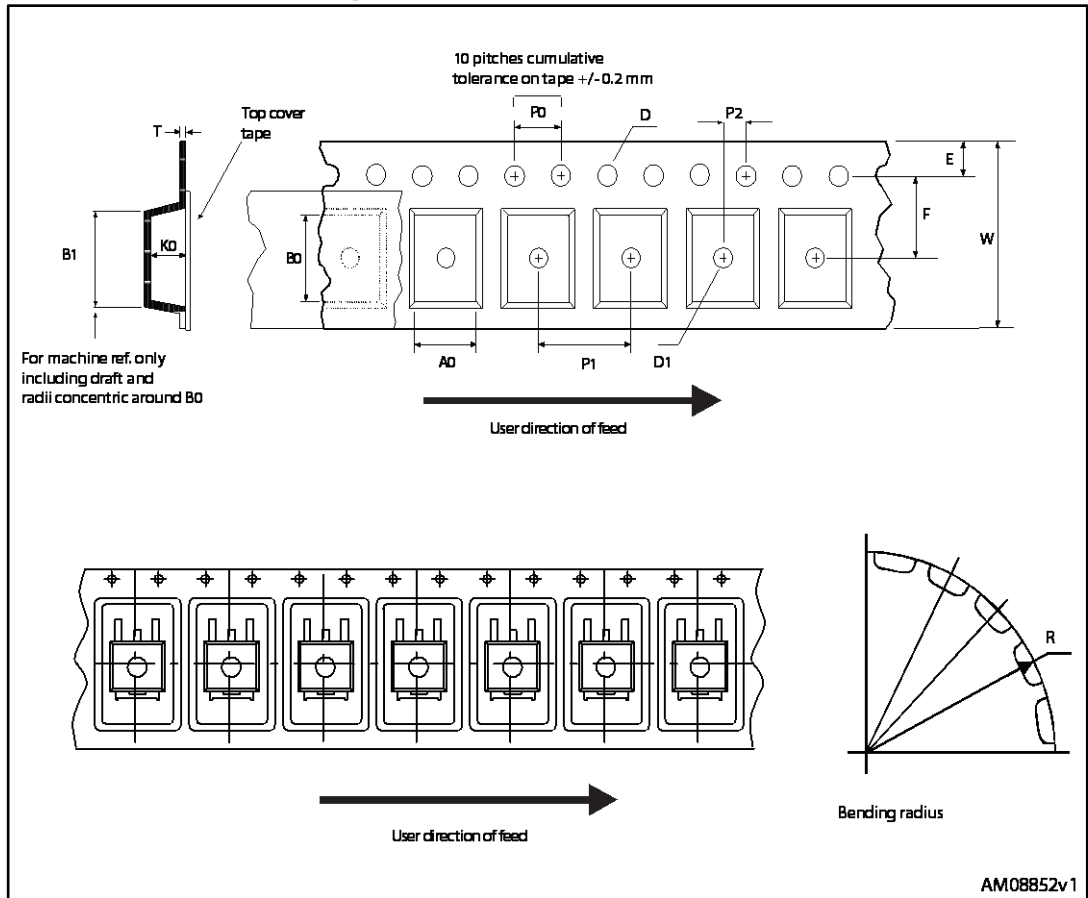

Figure 19: DPAK (TO-252) reel outline

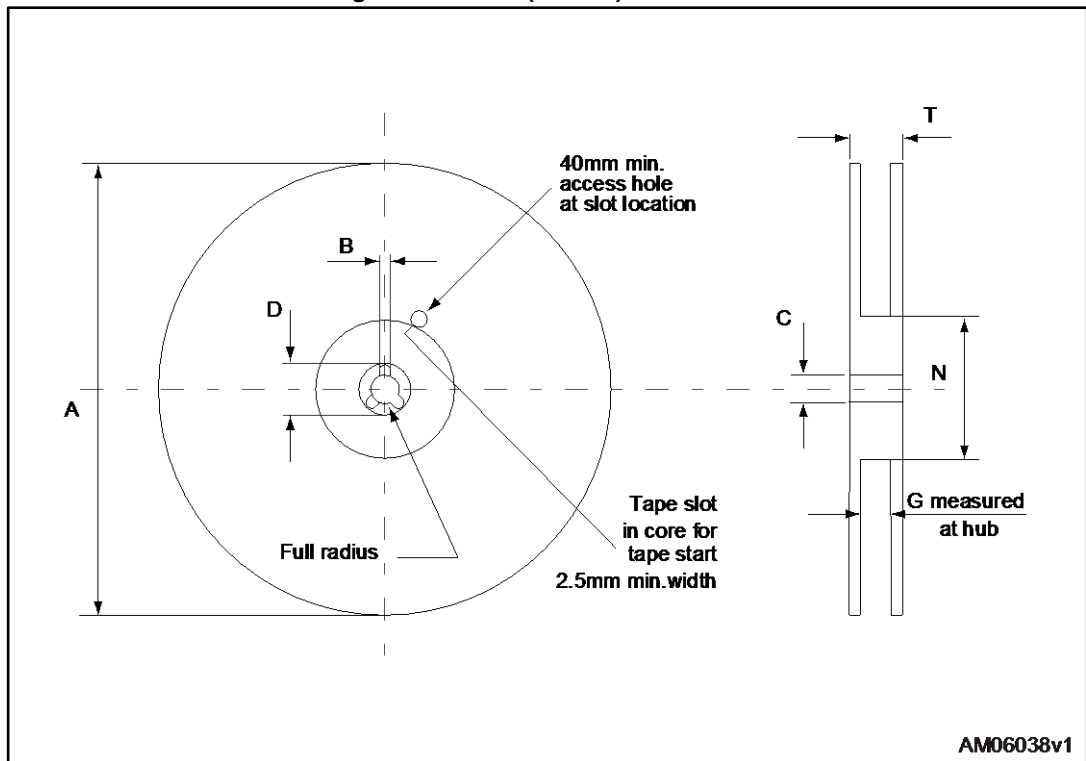

Table 9: DPAK (TO-252) tape and reel mechanical data

Tape			Reel		
Dim.	mm		Dim.	mm	
	Min.	Max.		Min.	Max.
A0	6.8	7	A		330
B0	10.4	10.6	B	1.5	
B1		12.1	C	12.8	13.2
D	1.5	1.6	D	20.2	
D1	1.5		G	16.4	18.4
E	1.65	1.85	N	50	
F	7.4	7.6	T		22.4
K0	2.55	2.75			
P0	3.9	4.1	Base qty.		2500
P1	7.9	8.1	Bulk qty.		2500
P2	1.9	2.1			
R	40				
T	0.25	0.35			
W	15.7	16.3			

5 Revision history

Table 10: Document revision history

Date	Revision	Changes
11-Dec-2013	1	First release.
24-Feb-2015	2	In title description on cover page, changed 0.02 Ω to 0.023 Ω In features table on cover page, changed 0.028 Ω to 0.026 Ω Updated Table 2: Absolute maximum ratings Updated Table 4: Static – renamed table and updated Static drainsource on-resistance values Updated Table 5: Dynamic – test conditions and all typical values Updated Table 6: Switching times – test conditions and all typical values Updated Table 7: Source-drain diode – test conditions and all typical values Added Section 2.2: Electrical characteristics (curves) Updated Section 4: Package mechanical data Minor text changes
03-Apr-2017	3	Updated V_{SD} maximum value in Table 7: "Source drain diode" . Updated Section 4.1: "DPAK package information" Minor text changes.

IMPORTANT NOTICE – PLEASE READ CAREFULLY

STMicroelectronics NV and its subsidiaries ("ST") reserve the right to make changes, corrections, enhancements, modifications, and improvements to ST products and/or to this document at any time without notice. Purchasers should obtain the latest relevant information on ST products before placing orders. ST products are sold pursuant to ST's terms and conditions of sale in place at the time of order acknowledgement.

Purchasers are solely responsible for the choice, selection, and use of ST products and ST assumes no liability for application assistance or the design of Purchasers' products.

No license, express or implied, to any intellectual property right is granted by ST herein.

Resale of ST products with provisions different from the information set forth herein shall void any warranty granted by ST for such product.



ST and the ST logo are trademarks of ST. All other product or service names are the property of their respective owners.

Information in this document supersedes and replaces information previously supplied in any prior versions of this document.

© 2017 STMicroelectronics – All rights reserved

Looking for pricing, stock, or lifecycle information?

Click below to explore more details on WIN SOURCE:

-  [View STD35P6LLF6 on WIN SOURCE](#)
-  [STMicroelectronics Information](#)

Optimize Your Supply Chain with WIN SOURCE Solutions

-  Global Sourcing Solution
-  Obsolete Management
-  Cost Control Management
-  Shortage Management
-  Alternative Solution
-  Excess Inventory Management