



**THE DATASHEET OF
CDRH2D11/HPNP-4R7NC**



SMD Power Inductor CDRH2D11B/HP



Halogen Free

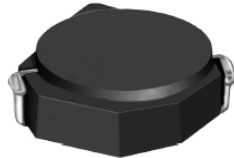

Description

- Ferrite drum core construction.
- Magnetically shielded.
- L × W × H: 3.2 × 3.2 × 1.2 mm Max.
- Product weight: 37mg(Ref.)
- Moisture Sensitivity Level: 1
- RoHS compliance.
- Halogen Free available.

Environmental Data

- Operating temperature range: -40°C~+105°C (including coil's self temperature rise)
- Storage temperature range: -40°C~+105°C
- Solder reflow temperature: 260 °C peak.

Packaging

- Carrier tape and reel packaging
- 7.0" diameter reel
- 1500pcs per reel

Applications

- Ideally used in Mobilephone, PDA, MP3, DSC/DVC, etc. as DC-DC converter inductors.

Dimension - [mm]

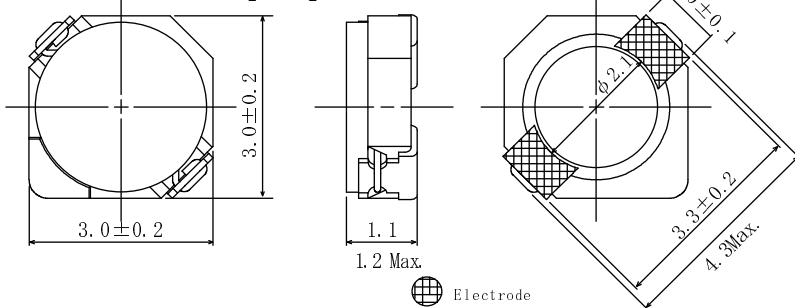

Land pattern and Schematics - [mm]

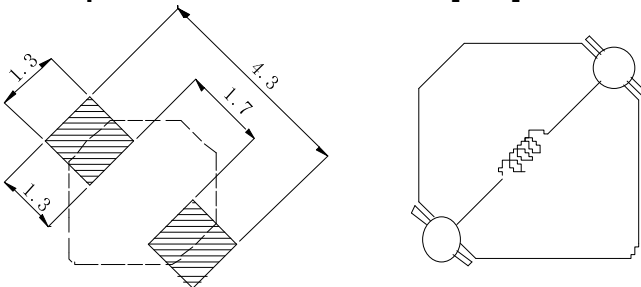

Electrical Characteristics

Part Name	Stamp	Inductance (μ H) [within] ※1	D.C.R. ($m\Omega$) Max. (Typ.) (at 20°C)	Saturation Current (A) ※2		Temperature Rise Current (A) ※3
				at 20°C	at 105°C	
CDRH2D11BHPHF-1R0PC	A	$1.0 \pm 25\%$	68.6(54.9)	2.10	1.70	1.75
CDRH2D11BHPHF-1R5PC	B	$1.5 \pm 25\%$	103.9(83.1)	1.65	1.40	1.45
CDRH2D11BHPHF-1R8PC	C	$1.8 \pm 25\%$	116.1(92.9)	1.50	1.30	1.30
CDRH2D11BHPHF-2R2PC	D	$2.2 \pm 25\%$	133.3(106.6)	1.40	1.20	1.15
CDRH2D11BHPHF-3R3PC	E	$3.3 \pm 25\%$	194.6(156.7)	1.15	0.94	0.95
CDRH2D11BHPHF-4R7PC	F	$4.7 \pm 25\%$	234.6(187.7)	0.95	0.80	0.80
CDRH2D11BHPHF-5R6PC	G	$5.6 \pm 25\%$	281.9(225.5)	0.90	0.75	0.76
CDRH2D11BHPHF-6R8PC	H	$6.8 \pm 25\%$	359.4(287.5)	0.78	0.65	0.65
CDRH2D11BHPHF-8R2PC	I	$8.2 \pm 25\%$	405.5(324.4)	0.73	0.60	0.62
CDRH2D11BHPHF-100PC	J	$10.0 \pm 25\%$	552.5(442.0)	0.63	0.52	0.52

※1. Inductance measuring condition: at 100kHz.

※2. Saturation current: The value of D.C. current when the inductance decreases to 65% of its nominal value.

※3. Temperature rise current: The value of D.C. current when the temperature rise is $\Delta t = 40^\circ\text{C}$ ($T_a = 20^\circ\text{C}$).

SMD Power Inductor CDRH2D11B/HP

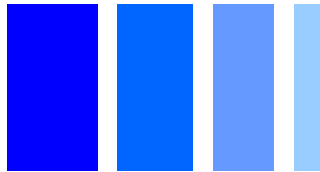

Saturation Current & Temperature Rise Graph

— L (20°C) — L (105°C) — ΔT

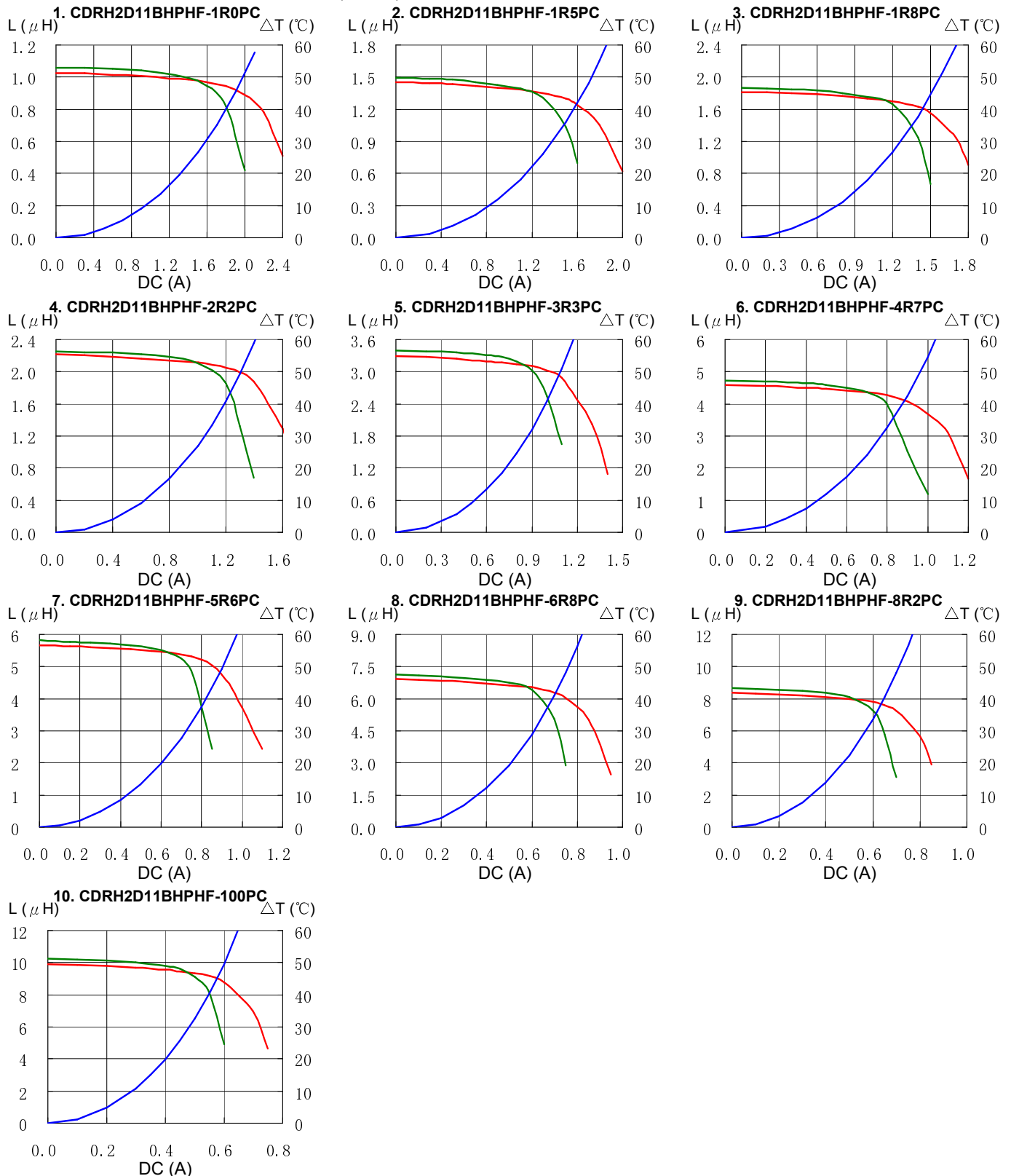

SMD Power Inductor CDRH2D11B/HP



Solder Reflow Condition

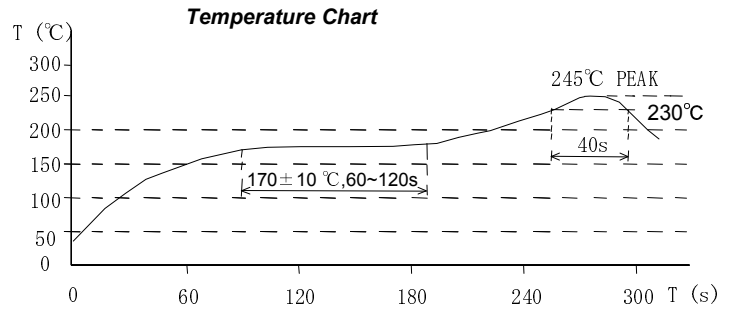
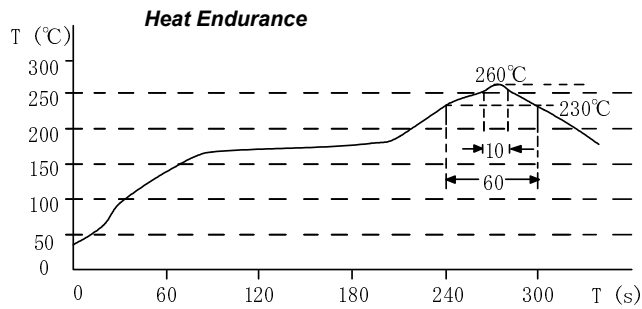

Please refer to the sales offices on our website - <http://www.sumida.com>

Hong Kong

Tel.+852-2880-6781
FAX.+852-2565-9600
sales@hk.sumida.com

Saitama(Japan)

Tel.+81-48-691-7300
FAX.+81-48-691-7340
sales@jp.sumida.com

Chicago

Tel.+1-847-545-6700
FAX. +1-847-545-6720
sales@us.sumida.com

Shanghai

Tel.+86-21-5836-3299
FAX.+86-21-5836-3266
shanghai.sales@cn.sumida.com

Seoul

Tel.+82-2-6237-0777
FAX.+82-2-6237-0778
sales@kr.sumida.com

Oberzell

Tel.+49-8591-937-0
FAX. +49-8591-937-103
contact@eu.sumida.com

Shenzhen

Tel.+86-755-8291-0228
FAX.+86-755-8291-0338
shenzhen.sales@cn.sumida.com

Singapore

Tel.+65-6296-3388
FAX.+65-6841-4426
sales@sg.sumida.com

Neumarkt

Tel.+49-9181-4509-110
FAX. +49-9181-4509-310
infocomp@eu.sumida.com

Taipei

Tel.+886-2-8751-2737
FAX.+886-2-8751-2738
sales@tw.sumida.com

San Jose

Tel.+1-408-321-9660
FAX.+1-408-321-9308
sales@us.sumida.com

Looking for pricing, stock, or lifecycle information?

Click below to explore more details on WIN SOURCE:

- ⊖ [View CDRH2D11/HPNP-4R7NC on WIN SOURCE](#)
- ⊖ [Sumida America Components Inc. Information](#)

Optimize Your Supply Chain with WIN SOURCE Solutions

- ✓ Global Sourcing Solution
- ✓ Obsolete Management
- ✓ Cost Control Management
- ✓ Shortage Management
- ✓ Alternative Solution
- ✓ Excess Inventory Management