



**THE DATASHEET OF
NVB5426NT4G**



NTB5426N, NTP5426N, NVB5426N



ON Semiconductor®

<http://onsemi.com>

Power MOSFET 120 Amps, 60 Volts N-Channel D²PAK, TO-220

Features

- Low $R_{DS(on)}$
- High Current Capability
- Avalanche Energy Specified
- AEC Q101 Qualified – NVB5426N
- These Devices are Pb-Free and are RoHS Compliant

Applications

- Power Supplies
- Converters
- Power Motor Controls
- Bridge Circuits

MAXIMUM RATINGS ($T_J = 25^\circ\text{C}$ Unless otherwise specified)

Parameter	Symbol	Value	Unit	
Drain-to-Source Voltage	V_{DSS}	60	V	
Gate-to-Source Voltage – Continuous	V_{GS}	± 20	V	
Gate-to-Source Voltage – Nonrepetitive ($T_P < 10 \mu\text{s}$)	V_{GS}	30	V	
Continuous Drain Current $R_{\theta JC}$ (Note 1)	Steady State	$T_C = 25^\circ\text{C}$	I_D 120	A
		$T_C = 100^\circ\text{C}$	85	
Power Dissipation $R_{\theta JC}$ (Note 1)	Steady State	$T_C = 25^\circ\text{C}$	P_D 215	W
Pulsed Drain Current	$t_p = 10 \mu\text{s}$	I_{DM} 260	A	
Operating and Storage Temperature Range	T_J, T_{stg}	-55 to +175	$^\circ\text{C}$	
Source Current (Body Diode)	I_S	60	A	
Single Pulse Drain-to-Source Avalanche Energy – Starting $T_J = 25^\circ\text{C}$ ($V_{DD} = 50 V_{dc}, V_{GS} = 10 V_{dc}, I_{L(pk)} = 70 \text{ A}, L = 0.3 \text{ mH}, R_G = 25 \Omega$)	E_{AS}	735	mJ	
Lead Temperature for Soldering Purposes, 1/8" from Case for 10 Seconds	T_L	260	$^\circ\text{C}$	

THERMAL RESISTANCE RATINGS

Parameter	Symbol	Max	Unit
Junction-to-Case (Drain) Steady State (Note 1)	$R_{\theta JC}$	0.7	$^\circ\text{C/W}$

Stresses exceeding Maximum Ratings may damage the device. Maximum Ratings are stress ratings only. Functional operation above the Recommended Operating Conditions is not implied. Extended exposure to stresses above the Recommended Operating Conditions may affect device reliability.

1. Surface mounted on FR4 board using 1 sq in pad size, (Cu Area 1.127 sq in [1 oz] including traces).

$V_{(BR)DSS}$	$R_{DS(ON) MAX}$	$I_D MAX$ (Note 1)
60 V	6.0 m Ω @ 10 V	120 A

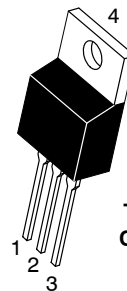
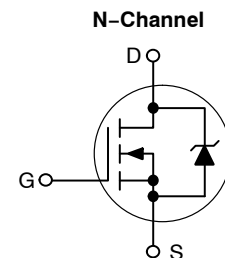

TO-220AB
CASE 221A
STYLE 5

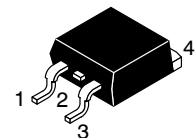

D²PAK
CASE 418B
STYLE 2

MARKING DIAGRAMS & PIN ASSIGNMENTS

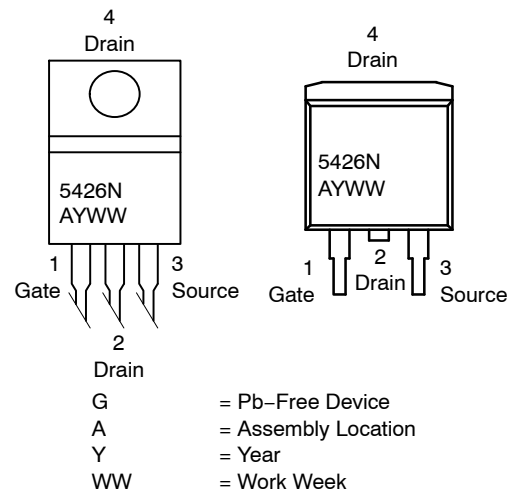

ORDERING INFORMATION

See detailed ordering and shipping information in the package dimensions section on page 2 of this data sheet.

NTB5426N, NTP5426N, NVB5426N

ELECTRICAL CHARACTERISTICS (T_J = 25°C Unless otherwise specified)

Characteristics	Symbol	Test Condition	Min	Typ	Max	Unit
OFF CHARACTERISTICS						
Drain-to-Source Breakdown Voltage	V _{(BR)DSS}	V _{DS} = 0 V, I _D = 250 μA	60			V
Drain-to-Source Breakdown Voltage Temperature Coefficient	V _{(BR)DSS} /T _J			64		mV/°C
Zero Gate Voltage Drain Current	I _{DSS}	V _{GS} = 0 V V _{DS} = 60 V	T _J = 25°C		1.0	μA
			T _J = 150°C		25	
Gate-Body Leakage Current	I _{GSS}	V _{DS} = 0 V, V _{GS} = ±20 V			±100	nA

ON CHARACTERISTICS (Note 2)

Gate Threshold Voltage	V _{GS(th)}	V _{GS} = V _{DS} , I _D = 250 μA	2.0	3.1	4.0	V
Negative Threshold Temperature Coefficient	V _{GS(th)} /T _J			9.2		mV/°C
Drain-to-Source On Voltage	V _{DS(on)}	V _{GS} = 10 V, I _D = 60 A		0.3	0.36	V
		V _{GS} = 10 V, I _D = 60 A, 150°C		0.6		
Static Drain-to-Source On-Resistance	R _{DS(on)}	V _{GS} = 10 V, I _D = 60 A		4.9	6.0	mΩ
Forward Transconductance	g _{FS}	V _{DS} = 15 V, I _D = 20 A		65		S

CHARGES, CAPACITANCES & GATE RESISTANCE

Input Capacitance	C _{iss}	V _{DS} = 25 V, V _{GS} = 0 V, f = 1 MHz		5800		pF
Output Capacitance	C _{oss}			1000		
Transfer Capacitance	C _{rss}			370		
Total Gate Charge	Q _{G(TOT)}	V _{GS} = 10 V, V _{DS} = 48 V, I _D = 60 A		150	170	nC
Threshold Gate Charge	Q _{G(TH)}			6.0		
Gate-to-Source Charge	Q _{GS}			28		
Gate-to-Drain Charge	Q _{GD}			67		

SWITCHING CHARACTERISTICS, V_{GS} = 10 V (Note 3)

Turn-On Delay Time	t _{d(on)}	V _{GS} = 10 V, V _{DD} = 48 V, I _D = 60 A, R _G = 3.0 Ω		15		ns
Rise Time	t _r			100		
Turn-Off Delay Time	t _{d(off)}			105		
Fall Time	t _f			95		

DRAIN-SOURCE DIODE CHARACTERISTICS

Forward Diode Voltage	V _{SD}	V _{GS} = 0 V I _S = 60 A	T _J = 25°C	0.88	1.1	V _{dc}
			T _J = 100°C	0.78		
Reverse Recovery Time	t _{rr}	I _S = 60 A _{dc} , V _{GS} = 0 V _{dc} , di _S /dt = 100 A/μs		75		ns
Charge Time	t _a			50		
Discharge Time	t _b			25		
Reverse Recovery Stored Charge	Q _{RR}			235		

- Pulse Test: Pulse Width ≤ 300 μs, Duty Cycle ≤ 2%.
- Switching characteristics are independent of operating junction temperatures.

ORDERING INFORMATION

Device	Package	Shipping [†]
NTP5426N	TO-220AB (Pb-Free)	50 Units / Rail
NTB5426NT4G	D ² PAK (Pb-Free)	800 / Tape & Reel
NVB5426NT4G	D ² PAK (Pb-Free)	800 / Tape & Reel

[†]For information on tape and reel specifications, including part orientation and tape sizes, please refer to our Tape and Reel Packaging Specifications Brochure, BRD8011/D.

TYPICAL CHARACTERISTICS

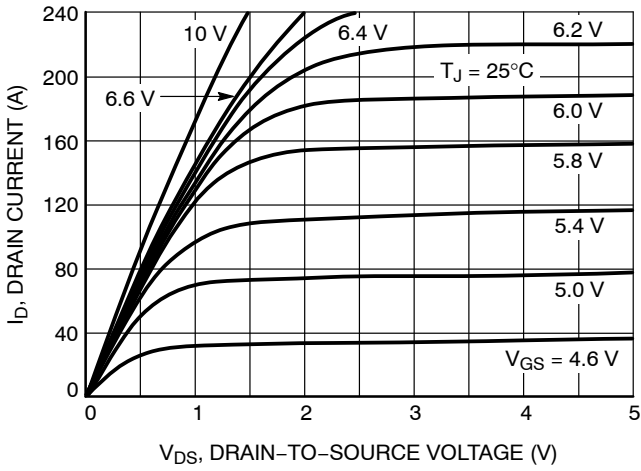

Figure 1. On-Region Characteristics

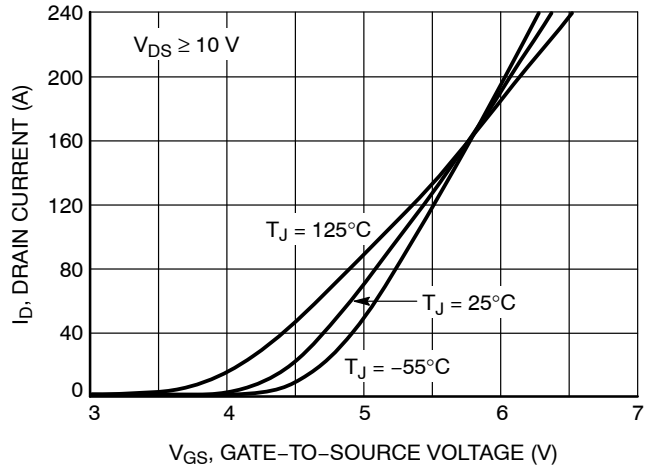

Figure 2. Transfer Characteristics

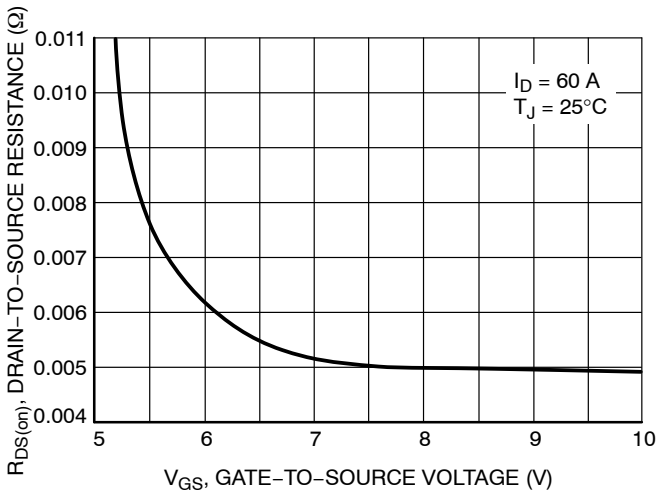

Figure 3. On-Resistance vs. Gate Voltage

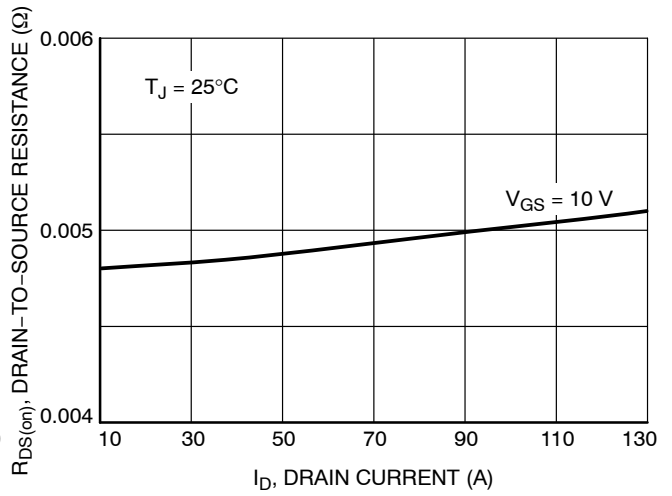

Figure 4. On-Resistance vs. Drain Current and Gate Voltage

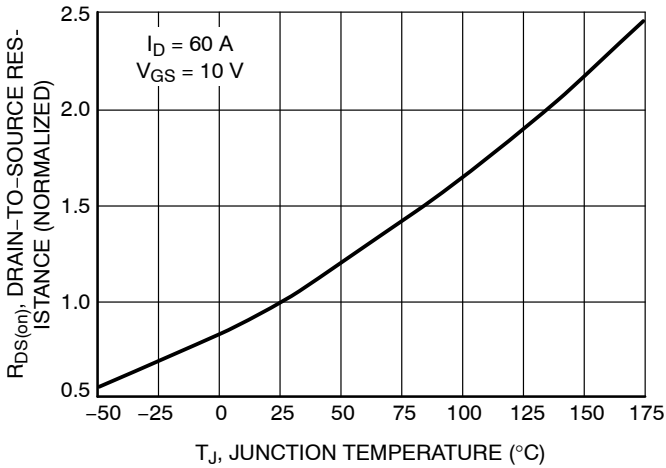

Figure 5. On-Resistance Variation with Temperature

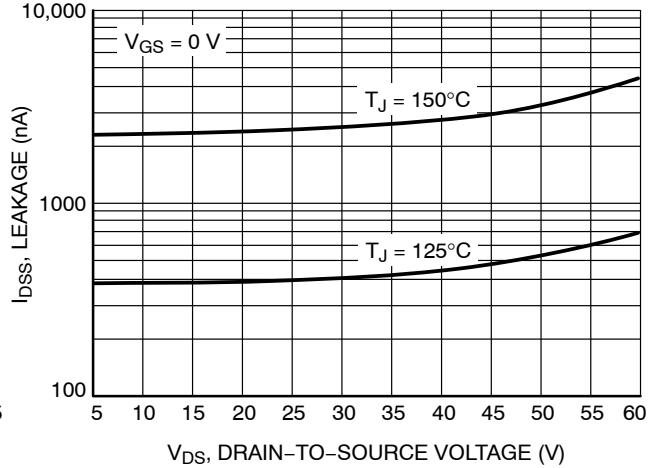

Figure 6. Drain-to-Source Leakage Current vs. Voltage

TYPICAL CHARACTERISTICS

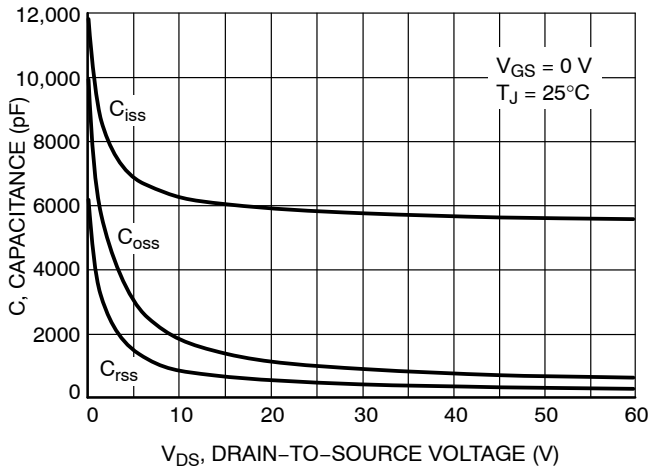

Figure 7. Capacitance Variation

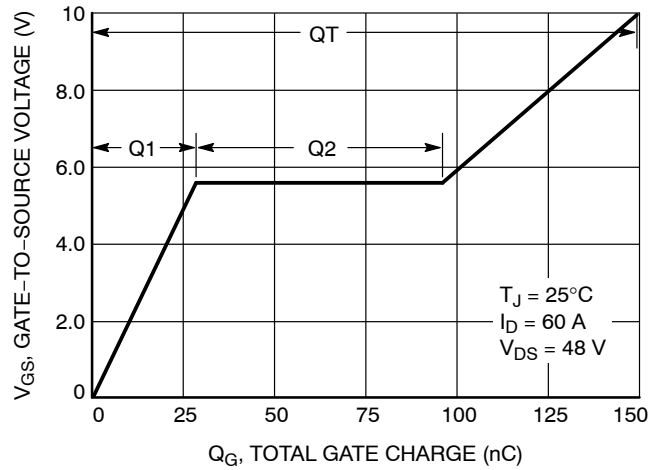

Figure 8. Gate-to-Source Voltage vs. Total Charge

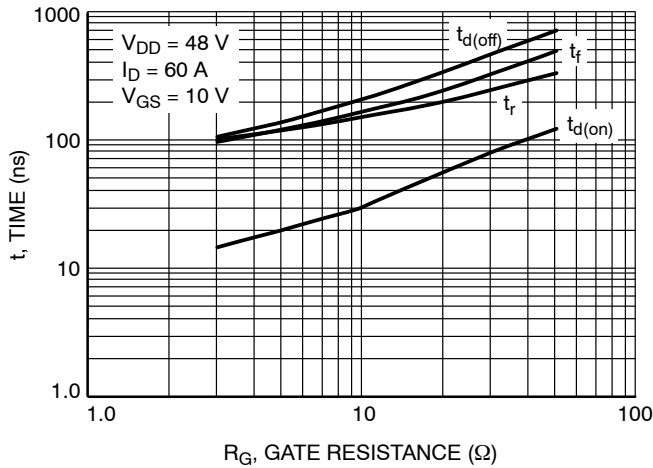

Figure 9. Resistive Switching Time Variation vs. Gate Resistance

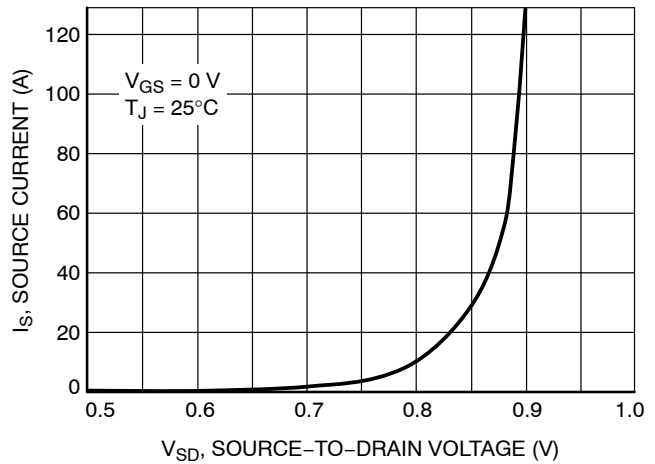

Figure 10. Diode Forward Voltage vs. Current

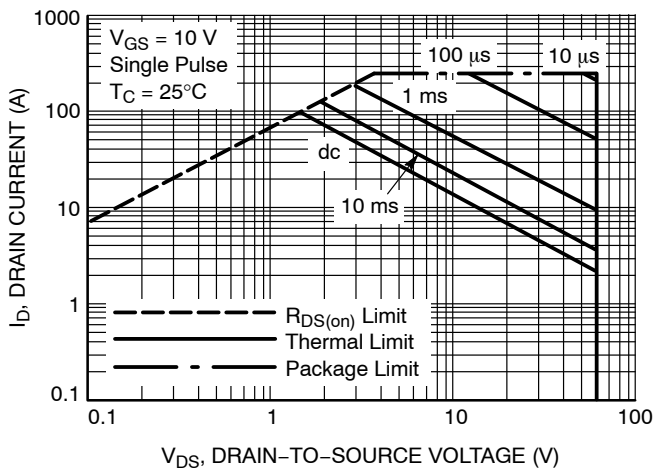

Figure 11. Maximum Rated Forward Biased Safe Operating Area

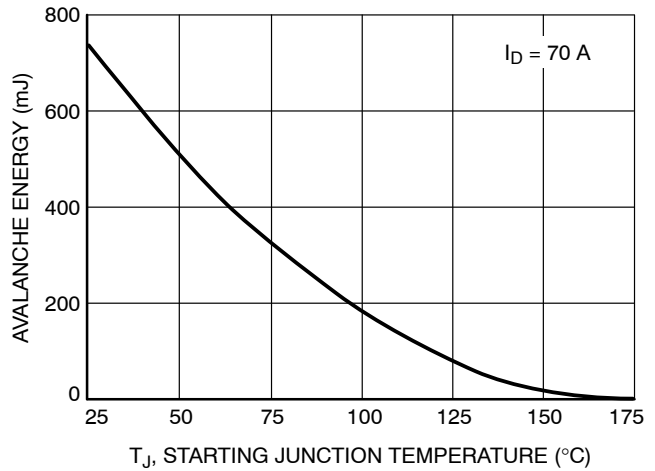

Figure 12. Maximum Avalanche Energy vs. Starting Junction Temperature

NTB5426N, NTP5426N, NVB5426N

TYPICAL CHARACTERISTICS

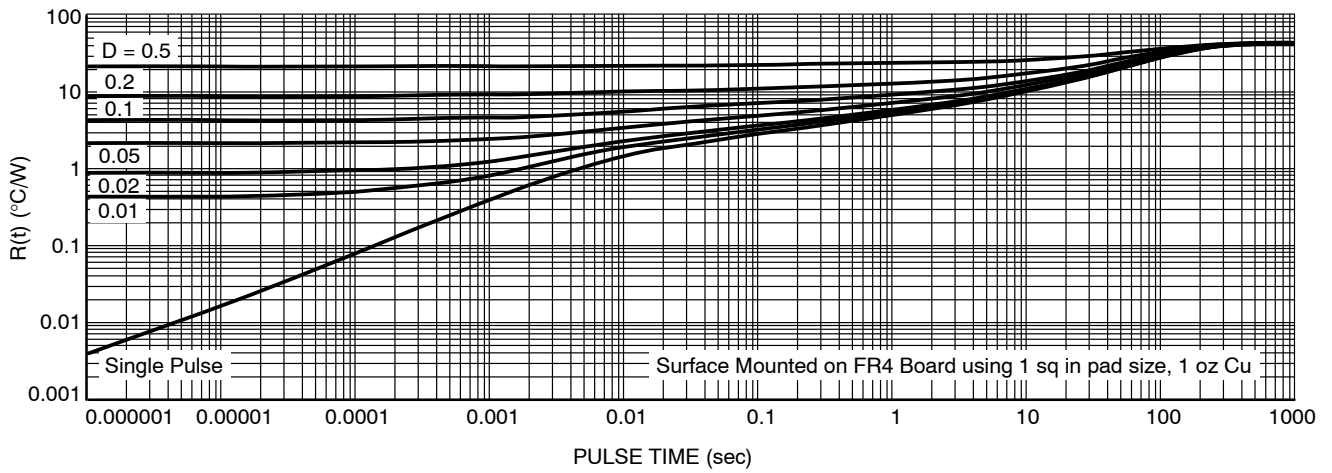
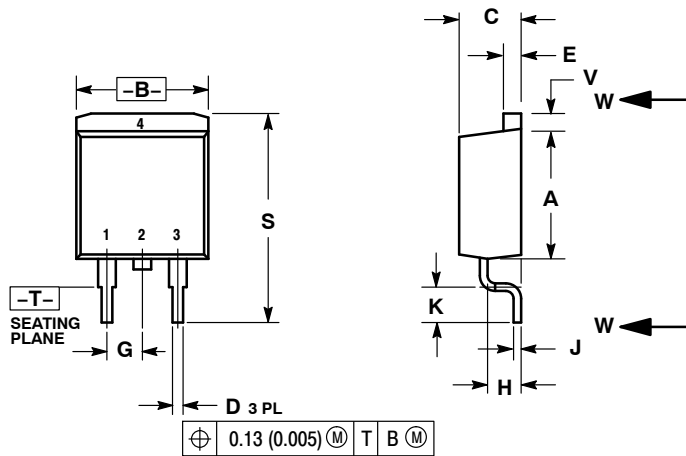

Figure 13. Thermal Response

NTB5426N, NTP5426N, NVB5426N

PACKAGE DIMENSIONS

D²PAK 3 CASE 418B-04 ISSUE K



NOTES:

1. DIMENSIONING AND TOLERANCING PER ANSI Y14.5M, 1982.
2. CONTROLLING DIMENSION: INCH.
3. 418B-01 THRU 418B-03 OBSOLETE, NEW STANDARD 418B-04.

DIM	INCHES		MILLIMETERS	
	MIN	MAX	MIN	MAX
A	0.340	0.380	8.64	9.65
B	0.380	0.405	9.65	10.29
C	0.160	0.190	4.06	4.83
D	0.020	0.035	0.51	0.89
E	0.045	0.055	1.14	1.40
F	0.310	0.350	7.87	8.89
G	0.100 BSC		2.54 BSC	
H	0.080	0.110	2.03	2.79
J	0.018	0.025	0.46	0.64
K	0.090	0.110	2.29	2.79
L	0.052	0.072	1.32	1.83
M	0.280	0.320	7.11	8.13
N	0.197 REF		5.00 REF	
P	0.079 REF		2.00 REF	
R	0.039 REF		0.99 REF	
S	0.575	0.625	14.60	15.88
V	0.045	0.055	1.14	1.40

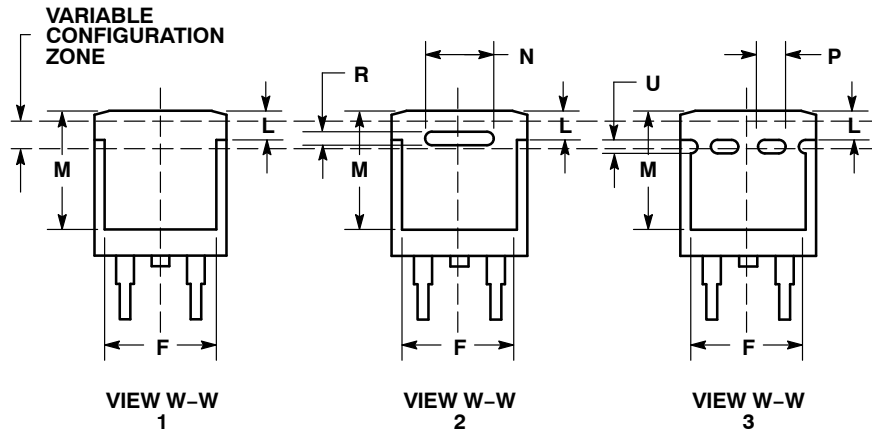

STYLE 2:

- PIN 1: GATE
2: DRAIN
3: SOURCE
4: DRAIN

SOLDERING FOOTPRINT*

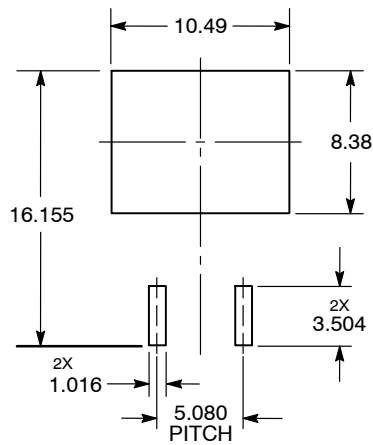

DIMENSIONS: MILLIMETERS

*For additional information on our Pb-Free strategy and soldering details, please download the ON Semiconductor Soldering and Mounting Techniques Reference Manual, SOLDERRM/D.

NTB5426N, NTP5426N, NVB5426N

PACKAGE DIMENSIONS

TO-220
CASE 221A-09
ISSUE AG

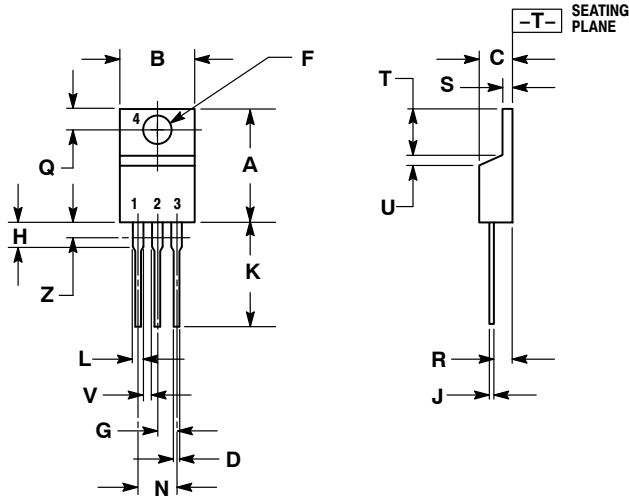

NOTES:

1. DIMENSIONING AND TOLERANCING PER ANSI Y14.5M, 1982.
2. CONTROLLING DIMENSION: INCH.
3. DIMENSION Z DEFINES A ZONE WHERE ALL BODY AND LEAD IRREGULARITIES ARE ALLOWED.

DIM	INCHES		MILLIMETERS	
	MIN	MAX	MIN	MAX
A	0.570	0.620	14.48	15.75
B	0.380	0.405	9.66	10.28
C	0.160	0.190	4.07	4.82
D	0.025	0.036	0.64	0.91
F	0.142	0.161	3.61	4.09
G	0.095	0.105	2.42	2.66
H	0.110	0.161	2.80	4.10
J	0.014	0.025	0.36	0.64
K	0.500	0.562	12.70	14.27
L	0.045	0.060	1.15	1.52
N	0.190	0.210	4.83	5.33
Q	0.100	0.120	2.54	3.04
R	0.080	0.110	2.04	2.79
S	0.045	0.055	1.15	1.39
T	0.235	0.255	5.97	6.47
U	0.000	0.050	0.00	1.27
V	0.045	---	1.15	---
Z	---	0.080	---	2.04

STYLE 5:

- PIN 1. GATE
2. DRAIN
3. SOURCE
4. DRAIN

ON Semiconductor and are registered trademarks of Semiconductor Components Industries, LLC (SCILLC). SCILLC reserves the right to make changes without further notice to any products herein. SCILLC makes no warranty, representation or guarantee regarding the suitability of its products for any particular purpose, nor does SCILLC assume any liability arising out of the application or use of any product or circuit, and specifically disclaims any and all liability, including without limitation special, consequential or incidental damages. "Typical" parameters which may be provided in SCILLC data sheets and/or specifications can and do vary in different applications and actual performance may vary over time. All operating parameters, including "Typicals" must be validated for each customer application by customer's technical experts. SCILLC does not convey any license under its patent rights nor the rights of others. SCILLC products are not designed, intended, or authorized for use as components in systems intended for surgical implant into the body, or other applications intended to support or sustain life, or for any other application in which the failure of the SCILLC product could create a situation where personal injury or death may occur. Should Buyer purchase or use SCILLC products for any such unintended or unauthorized application, Buyer shall indemnify and hold SCILLC and its officers, employees, subsidiaries, affiliates, and distributors harmless against all claims, costs, damages, and expenses, and reasonable attorney fees arising out of, directly or indirectly, any claim of personal injury or death associated with such unintended or unauthorized use, even if such claim alleges that SCILLC was negligent regarding the design or manufacture of the part. SCILLC is an Equal Opportunity/Affirmative Action Employer. This literature is subject to all applicable copyright laws and is not for resale in any manner.

PUBLICATION ORDERING INFORMATION

LITERATURE FULFILLMENT:
Literature Distribution Center for ON Semiconductor
P.O. Box 5163, Denver, Colorado 80217 USA
Phone: 303-675-2175 or 800-344-3860 Toll Free USA/Canada
Fax: 303-675-2176 or 800-344-3867 Toll Free USA/Canada
Email: orderlit@onsemi.com

N. American Technical Support: 800-282-9855 Toll Free
USA/Canada
Europe, Middle East and Africa Technical Support:
Phone: 421 33 790 2910
Japan Customer Focus Center
Phone: 81-3-5773-3850

ON Semiconductor Website: www.onsemi.com
Order Literature: <http://www.onsemi.com/orderlit>
For additional information, please contact your local Sales Representative

Looking for pricing, stock, or lifecycle information?

Click below to explore more details on WIN SOURCE:

 [View NVB5426NT4G on WIN SOURCE](#)

 [ON Semiconductor](#) Information

Optimize Your Supply Chain with WIN SOURCE Solutions

-  Global Sourcing Solution
-  Obsolete Management
-  Cost Control Management
-  Shortage Management
-  Alternative Solution
-  Excess Inventory Management