

Dual-Channel, High-Performance 300 mA μ Cap ULDO

Features

- 2.3V to 5.5V Input Voltage Range
- Ultra-Low Dropout Voltage: 75 mV @ 300 mA
- Ultra-Small 1.6 mm x 1.6 mm x 0.55 mm 6-Lead Thin DFN Package
- Independent Enable Pins
- High PSRR (over 65 dB @ 1 kHz)
- 300 mA Output Current per LDO
- μ Cap Stable with 1 μ F Ceramic Capacitor
- Low Quiescent Current: 90 μ A/LDO
- Fast Turn-On Time: 30 μ s
- Thermal Shutdown Protection
- Current Limit Protection

Applications

- Mobile Phones
- PDAs
- GPS Receivers
- Portable Electronics
- Portable Media Players
- Digital Still and Video Cameras

General Description

The MIC5335 is a high current density, dual Ultra-Low Dropout (ULDO) linear regulator. The MIC5335 is ideally suited for portable electronics that demand overall high performance in a very small form factor. The MIC5335 is offered in the ultra-small 1.6 mm x 1.6 mm x 0.55 mm 6-lead Thin DFN package, which is only 2.56 mm² in area. The MIC5335 has an exceptional thermal performance for applications that demand higher power dissipation in a very small footprint. In addition, the MIC5335 integrates two high-performance 300 mA LDOs with independent enable functions and offers high PSRR, eliminating the need for a bypass capacitor.

The MIC5335 is a μ Cap design that enables operation with very small output capacitors for stability, thereby reducing required board space and component cost.

The MIC5335 is available in fixed-output voltages. Additional voltages are available upon customer request.

Package Type

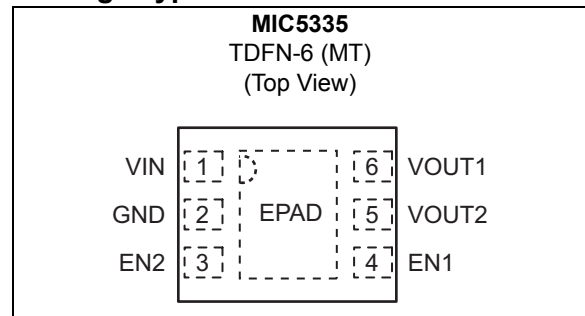

MIC5335

Typical Application Circuit

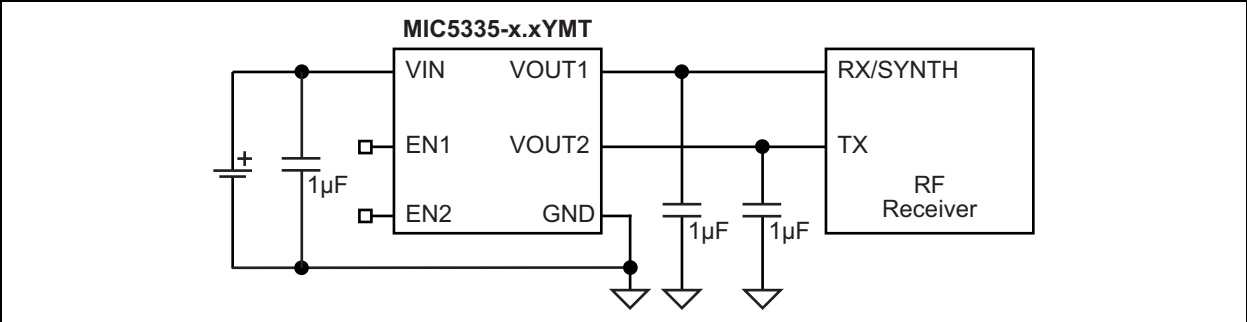

Functional Block Diagram

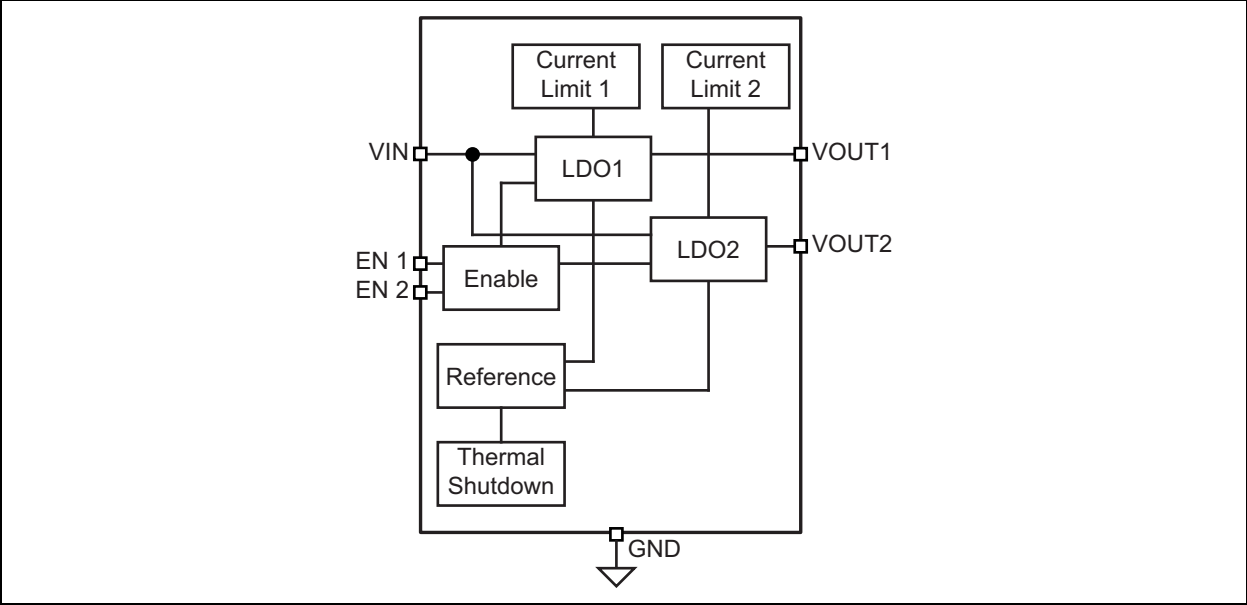

1.0 ELECTRICAL CHARACTERISTICS

Absolute Maximum Ratings †

Supply Voltage (V_{IN})	0V to +6V
Enable Input Voltage (V_{EN})	0V to +6V
Power Dissipation	Internally Limited, Note 1
Lead Temperature (Soldering, 3 sec.)	+260°C
Storage Temperature (T_S)	-65°C to +150°C
ESD Rating (Note 2)	2 kV

Operating Ratings ††

Supply Voltage (V_{IN})	+2.3V to +5.5V
Enable Input Voltage (V_{EN})	0V to V_{IN}
Junction Temperature (T_J)	-40°C to +125°C
Thermal Resistance, TDFN-6 (θ_{JA})	100°C/W

† **Notice:** Stresses above those listed under “Absolute Maximum Ratings” may cause permanent damage to the device. This is a stress rating only and functional operation of the device at those or any other conditions above those indicated in the operational sections of this specification is not intended. Exposure to maximum rating conditions for extended periods may affect device reliability.

†† **Notice:** The device is not guaranteed to function outside its operating ratings.

Note 1: The maximum allowable power dissipation of any T_A (ambient temperature) is $P_{D(MAX)} = (T_{J(MAX)} - T_A)/\theta_{JA}$. Exceeding the maximum allowable power dissipation will result in excessive die temperature and the regulator will go into thermal shutdown.

2: Devices are ESD sensitive. Handling precautions are recommended. Human body model, 1.5 kΩ in series with 100 pF.

ELECTRICAL CHARACTERISTICS

Electrical Characteristics: $V_{IN} = EN1 = EN2 = V_{OUT} + 1.0V$; higher of the two regulator outputs, $I_{OUTLDO1} = I_{OUTLDO2} = 100 \mu A$; $C_{OUT1} = C_{OUT2} = 1 \mu F$; $T_J = +25^\circ C$, **bold** values indicate $-40^\circ C \leq T_J \leq +125^\circ C$, unless noted.

[Note 1](#)

Parameter	Sym.	Min.	Typ.	Max.	Units	Conditions
Output Voltage Accuracy		-2.0	—	2.0	%	Variation from nominal V_{OUT}
		-3.0	—	3.0	%	Variation from nominal V_{OUT} ; -40°C to +125°C
Line Regulation	—	—	0.02	0.3	%/ V	$V_{IN} = V_{OUT} + 1V$ to 5.5V; $I_{OUT} = 100 \mu A$
		—	—	0.6		—
Load Regulation	—	—	0.3	2.0	%	$I_{OUT} = 100 \mu A$ to 300 mA
Dropout Voltage, Note 2	V_{DO}	—	0.1	—	mV	$I_{OUT} = 100 \mu A$
		—	25	75		$I_{OUT} = 100 mA$
		—	35	100		$I_{OUT} = 150 mA$
		—	75	200		$I_{OUT} = 300 mA$

Note 1: Specification for packaged product only.

2: Dropout voltage is defined as the input-to-output differential at which the output voltage drops 2% below its nominal V_{OUT} . For outputs below 2.3V, the dropout voltage is the input-to-output differential with the minimum input voltage 2.3V.

MIC5335

ELECTRICAL CHARACTERISTICS (CONTINUED)

Electrical Characteristics: $V_{IN} = EN1 = EN2 = V_{OUT} + 1.0V$; higher of the two regulator outputs, $I_{OUTLDO1} = I_{OUTLDO2} = 100 \mu A$; $C_{OUT1} = C_{OUT2} = 1 \mu F$; $T_J = +25^\circ C$, **bold** values indicate $-40^\circ C \leq T_J \leq +125^\circ C$, unless noted.

Note 1

Parameter	Sym.	Min.	Typ.	Max.	Units	Conditions
Ground Current	I_{GND}	—	90	125	μA	EN1 = High; EN2 = Low; $I_{OUT} = 100 \mu A$ to 300 mA
		—	90	125		EN1 = Low; EN2 = High; $I_{OUT} = 100 \mu A$ to 300 mA
		—	150	220		EN1 = EN2 = High; $I_{OUT1} = 300 mA$, $I_{OUT2} = 300 mA$
Ground Current in Shutdown	I_{SHDN}	—	0.01	2	μA	EN1 = EN2 = 0V
Ripple Rejection	PSRR	—	65	—	dB	f = 1 kHz; $C_{OUT} = 1.0 \mu F$
		—	45	—		f = 20 kHz; $C_{OUT} = 1.0 \mu F$
Current Limit	I_{LIM}	340	550	950	mA	$V_{OUT} = 0V$
Output Voltage Noise		—	90	—	μV_{RMS}	$C_{OUT} = 1.0 \mu F$; 10 Hz to 100 kHz
Enable Inputs (EN1/EN2)						
Enable Input Voltage	V_{EN}	—	—	0.2	V	Logic low
		1.1	—	—		Logic high
Enable Input Current	I_{EN}	—	0.01	1	μA	$V_{IL} \leq 0.2V$
		—	0.01	1		$V_{IH} \geq 1.0V$
Turn-On Time (see Timing Diagram)						
Turn-On Time (LDO1 and LDO2)	t_{ON}	—	30	100	μs	$C_{OUT} = 1.0 \mu F$

Note 1: Specification for packaged product only.

- 2:** Dropout voltage is defined as the input-to-output differential at which the output voltage drops 2% below its nominal V_{OUT} . For outputs below 2.3V, the dropout voltage is the input-to-output differential with the minimum input voltage 2.3V.

TEMPERATURE SPECIFICATIONS

Parameters	Sym.	Min.	Typ.	Max.	Units	Conditions
Temperature Ranges						
Storage Temperature Range	T_S	-65	—	+150	°C	—
Lead Temperature	—	—	—	+260	°C	Soldering, 3 sec.
Junction Temperature Range	T_J	-40	—	+125	°C	—
Package Thermal Resistances						
Thermal Resistance, 1.6x1.6 TDFN 6-Ld	θ_{JA}	—	100	—	°C/W	—

Note 1: The maximum allowable power dissipation is a function of ambient temperature, the maximum allowable junction temperature and the thermal resistance from junction to air (i.e., T_A , T_J , θ_{JA}). Exceeding the maximum allowable power dissipation will cause the device operating junction temperature to exceed the maximum +125°C rating. Sustained junction temperatures above +125°C can impact the device reliability.

MIC5335

2.0 TYPICAL PERFORMANCE CURVES

Note: The graphs and tables provided following this note are a statistical summary based on a limited number of samples and are provided for informational purposes only. The performance characteristics listed herein are not tested or guaranteed. In some graphs or tables, the data presented may be outside the specified operating range (e.g., outside specified power supply range) and therefore outside the warranted range.

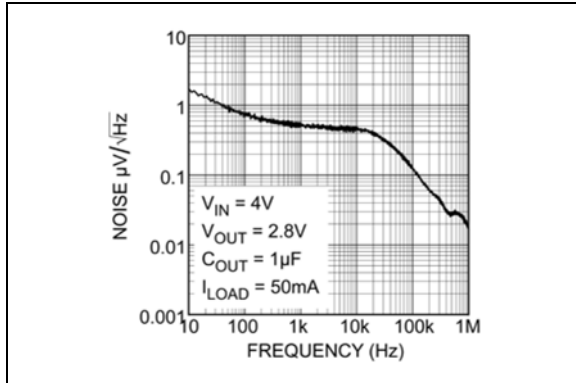

FIGURE 2-1: Output Noise Spectral Density.

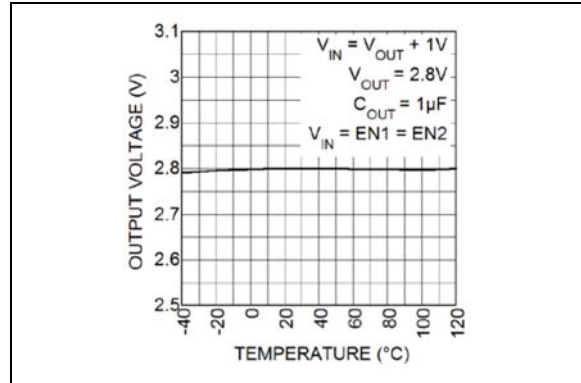

FIGURE 2-4: Output Voltage vs. Temperature.

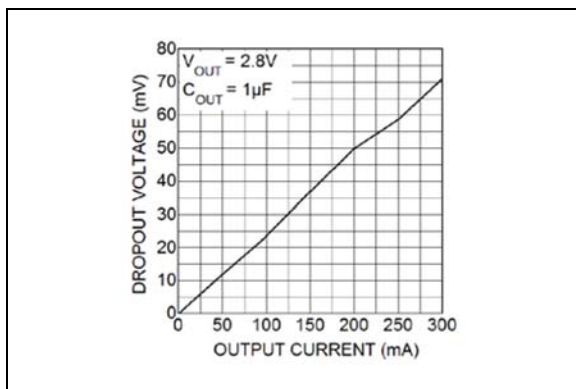

FIGURE 2-2: Dropout Voltage vs. Output Current.

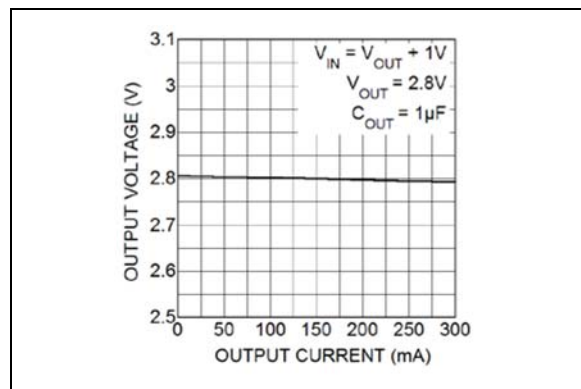

FIGURE 2-5: Output Voltage vs. Output Current.

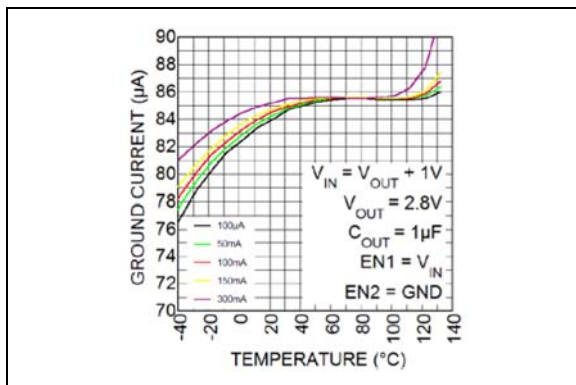

FIGURE 2-3: Ground Current vs. Temperature.

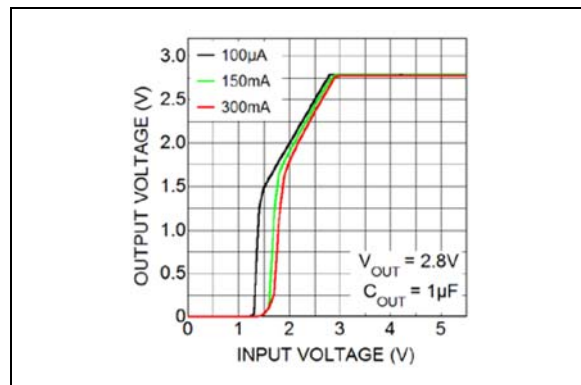

FIGURE 2-6: Output Voltage vs. Input Voltage.

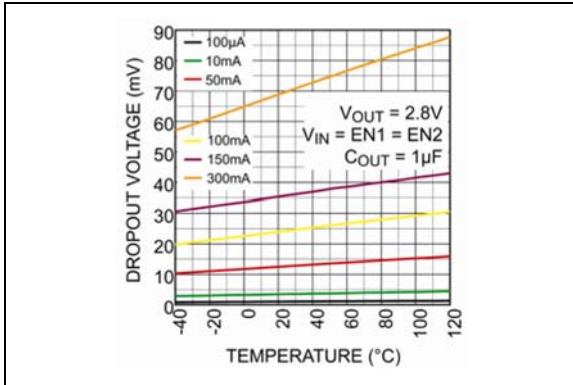

FIGURE 2-7: Dropout Voltage vs. Temperature.

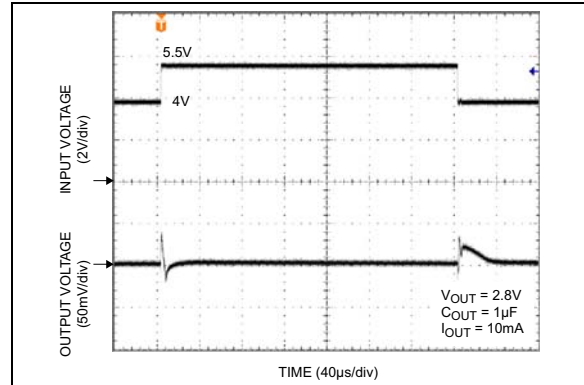

FIGURE 2-10: Line Transient.

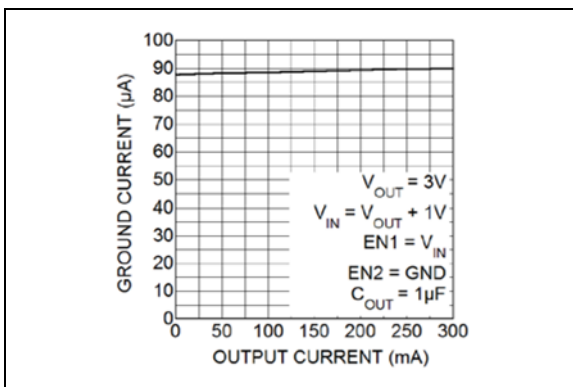

FIGURE 2-8: Ground Current vs. Output Current.

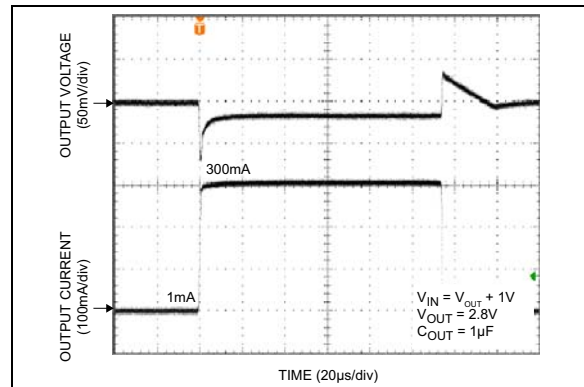

FIGURE 2-11: Load Transient.

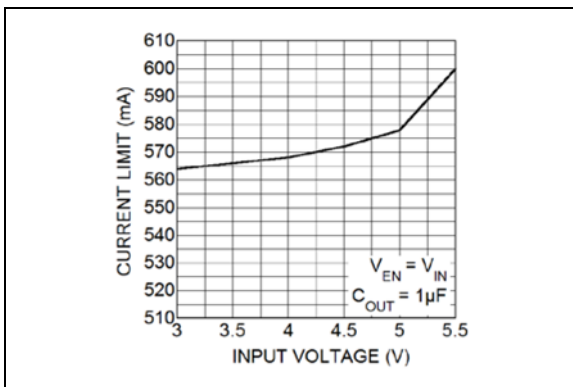

FIGURE 2-9: Current Limit.

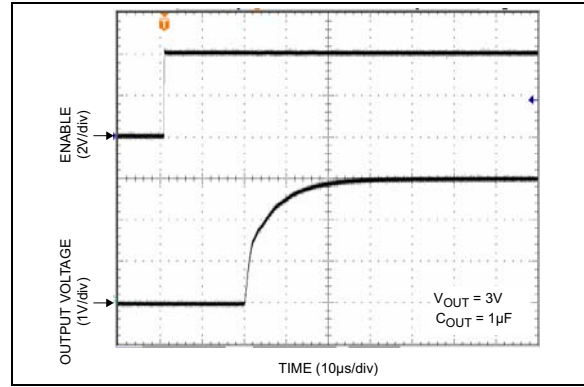

FIGURE 2-12: Enable Turn-On.

MIC5335

3.0 PIN DESCRIPTIONS

The descriptions of the pins are listed in [Table 3-1](#).

TABLE 3-1: PIN FUNCTION TABLE

Pin Number	Pin Name	Description
1	VIN	Supply Input.
2	GND	Ground.
3	EN2	LDO2 Enable Active-High Input. Logic High = On; Logic Low = Off; Do not leave floating.
4	EN1	LDO1 Enable Active-High Input. Logic High = On; Logic Low = Off; Do not leave floating.
5	VOUT2	Regulator Output – LDO2.
6	VOUT1	Regulator Output – LDO1.
EPAD	ePad	Exposed heat sink pad connected internally to ground.

4.0 APPLICATION INFORMATION

4.1 Enable/Shutdown

The MIC5335 comes with dual active-high enable pins that allow each regulator to be enabled independently. Forcing the enable pin low disables the regulator and sends it into a “zero” off-mode current state. In this state, current consumed by the regulator goes nearly to zero. Forcing the enable pin high enables the output voltage. The active-high enable pin uses CMOS technology and the enable pin cannot be left floating; a floating enable pin may cause an indeterminate state on the output.

4.2 Input Capacitor

The MIC5335 is a high-performance, high-bandwidth device. Therefore, it requires a well-bypassed input supply for optimal performance. A 1 μF capacitor is required from the input to ground to provide stability. Low-ESR ceramic capacitors provide optimal performance at a minimum of space. Additional high-frequency capacitors, such as small-valued NPO dielectric-type capacitors, help filter out high-frequency noise and are good practice in any RF-based circuit.

4.3 Output Capacitor

The MIC5335 requires an output capacitor of 1 μF or greater to maintain stability. The design is optimized for use with low-ESR ceramic chip capacitors. High-ESR capacitors may cause high frequency oscillation. The output capacitor can be increased, but performance has been optimized for a 1 μF ceramic output capacitor and does not improve significantly with larger capacitance.

X7R/X5R dielectric-type ceramic capacitors are recommended because of their temperature performance. X7R-type capacitors change capacitance by 15% over their operating temperature range and are the most stable type of ceramic capacitors on the market. Z5U and Y5V dielectric capacitors change value by as much as 50% and 60%, respectively, over their operating temperature ranges. To use a ceramic chip capacitor with Y5V dielectric, the value must be much higher than an X7R ceramic capacitor to ensure the same minimum capacitance over the equivalent operating temperature range.

4.4 No-Load Stability

Unlike many other voltage regulators, the MIC5335 will remain stable and in regulation with no load. This is especially important in CMOS RAM keep-alive applications.

4.5 Thermal Considerations

The MIC5335 is designed to provide 300 mA of continuous current for both outputs in a very small package. Maximum ambient operating temperature can be calculated based upon the output current and the voltage drop across the part. Given that the input voltage is 3.3V, the output voltage is 2.8V for V_{OUT1} , 2.5V for V_{OUT2} , and the output current is 300 mA. The actual power dissipation of the regulator circuit can be determined using the equation:

EQUATION 4-1:

$$P_D = (V_{IN} - V_{OUT1}) \times I_{OUT1} + (V_{IN} - V_{OUT2}) \times I_{OUT2} + V_{IN} \times I_{GND}$$

$$P_D = (3.3V - 2.8V) \times 300mA + (3.3V - 2.5V) \times 300mA$$

$$P_D = 0.39W$$

Because this device is CMOS and the ground current is typically $<100\mu\text{A}$ over the load range, the power dissipation contributed by the ground current is $<1\%$ and can be ignored for [Equation 4-1](#).

To determine the maximum ambient operating temperature of the package, use the junction-to-ambient thermal resistance of the device and the following basic equation:

EQUATION 4-2:

$$P_{D(MAX)} = \frac{T_{J(MAX)} - T_A}{\theta_{JA}}$$

Where:
 $T_{J(MAX)} = 125^\circ\text{C}$, the max. junction temp of the die.
 $\theta_{JA} = 100^\circ\text{C/W}$ thermal resistance.

The table that follows shows junction-to-ambient thermal resistance for the MIC5335 in the Thin DFN package.

TABLE 4-1: THERMAL RESISTANCE

θ_{JA} Recommended Minimum Footprint	θ_{JC}
100°C/W	2°C/W

Substituting P_D for $P_{D(MAX)}$ and solving for the ambient operating temperature will give the maximum operating conditions for the regulator circuit. The junction-to-ambient thermal resistance for the minimum footprint is 100°C/W.

MIC5335

The maximum power dissipation must not be exceeded for proper operation.

For example, when operating the MIC5335-MFYML at an input voltage of 3.3V and 300 mA loads on each output with a minimum footprint layout, the maximum ambient operating temperature T_A can be determined as follows:

EQUATION 4-3:

$$0.39 W = \frac{125^{\circ}C - T_A}{100^{\circ}C/W}$$

$$T_A = 86^{\circ}C$$

Therefore, a 2.8V/2.5V application with 300 mA at each output current can accept an ambient operating temperature of 86°C in a 1.6 mm x 1.6 mm Thin DFN package.

5.0 PACKAGING INFORMATION

5.1 Package Marking Information

6-Lead TDFN*

Example

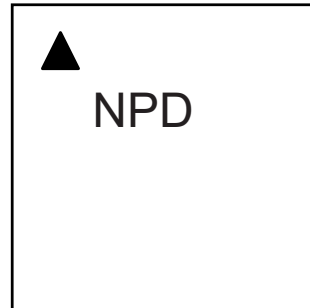
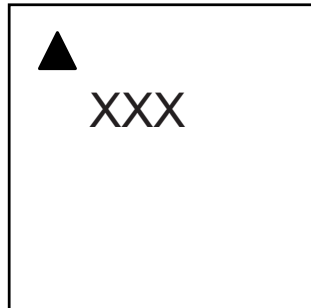

For a detailed breakdown of part numbers, their markings, and voltages, please see [Table 5-1](#).

<p>Legend:</p> <ul style="list-style-type: none"> XX...X Product code or customer-specific information Y Year code (last digit of calendar year) YY Year code (last 2 digits of calendar year) WW Week code (week of January 1 is week '01') NNN Alphanumeric traceability code (e3) Pb-free JEDEC® designator for Matte Tin (Sn) * This package is Pb-free. The Pb-free JEDEC designator ((e3)) can be found on the outer packaging for this package. •, ▲, ▼ Pin one index is identified by a dot, delta up, or delta down (triangle mark). 	<p>Note: In the event the full Microchip part number cannot be marked on one line, it will be carried over to the next line, thus limiting the number of available characters for customer-specific information. Package may or may not include the corporate logo.</p> <p>Underbar (_) and/or Overbar (¯) symbol may not be to scale.</p>
--	---

MIC5335

TABLE 5-1: PACKAGE MARKING

Part Number	Marking	Voltage	Part Number	Marking	Voltage
MIC5335-GFYMT	GPF	1.8V/1.5V	MIC5335-PGYMT	PPG	3.0V/1.8V
MIC5335-GWYMT	GPW	1.8V/1.6V	MIC5335-PJYMT	PPJ	3.0V/2.5V
MIC5335-GGYMT	GPG	1.8V/1.8V	MIC5335-PKYMT	PPK	3.0V/2.6V
MIC5335-JGYMT	JPG	2.5V/1.8V	MIC5335-PMYMT	PPM	3.0V/2.8V
MIC5335-JJYMT	JPJ	2.5V/2.5V	MIC5335-PNYMT	PPN	3.0V/2.85V
MIC5335-KDYMT	KPD	2.6V/1.85	MIC5335-PPYMT	PPP	3.0V/3.0V
MIC5335-KGYMT	KPG	2.6V/1.8V	MIC5335-SFYMT	SPF	3.3V/1.5V
MIC5335-LLYMT	LPL	2.7V/2.7V	MIC5335-SGYMT	SPG	3.3V/1.8V
MIC5335-MFYMT	MPF	2.8V/1.5V	MIC5335-SJYMT	SPJ	3.3V/2.5V
MIC5335-MGYMT	MPG	2.8V/1.8V	MIC5335-SKYMT	SPK	3.3V/2.6V
MIC5335-MKYMT	MPK	2.8V/2.6V	MIC5335-SLYMT	SPL	3.3V/2.7V
MIC5335-MMYMT	MPM	2.8V/2.8V	MIC5335-SMYMT	SPM	3.3V/2.8V
MIC5335-NDYMT	NPD	2.85V/1.85V	MIC5335-SNYMT	SPN	3.3V/2.85V
MIC5335-NKYMT	NPK	2.85V/2.6V	MIC5335-SOYMT	SPO	3.3V/2.9V
MIC5335-NNYMT	NPN	2.85V/2.85V	MIC5335-SPYMT	SPP	3.3V/3.0V
MIC5335-OFYMT	OPF	2.9V/1.5V	MIC5335-SRYMT	SPR	3.3V/3.2V
MIC5335-OGYMT	OPG	2.9V/1.8V	MIC5335-SSYMT	SPS	3.3V/3.3V
MIC5335-OOYMT	OPO	2.9V/2.9V	MIC5335-XXYMT	XPX	3.15V/3.15V

6-Lead TDFN 1.6 mm x 1.6 mm Package Outline & Recommended Land Pattern

TITLE

6 LEAD TDFN 1.6x1.6mm PACKAGE OUTLINE & RECOMMENDED LAND PATTERN

DRAWING #	TDFN1616-6LD-PL-1	UNIT	MM
-----------	-------------------	------	----

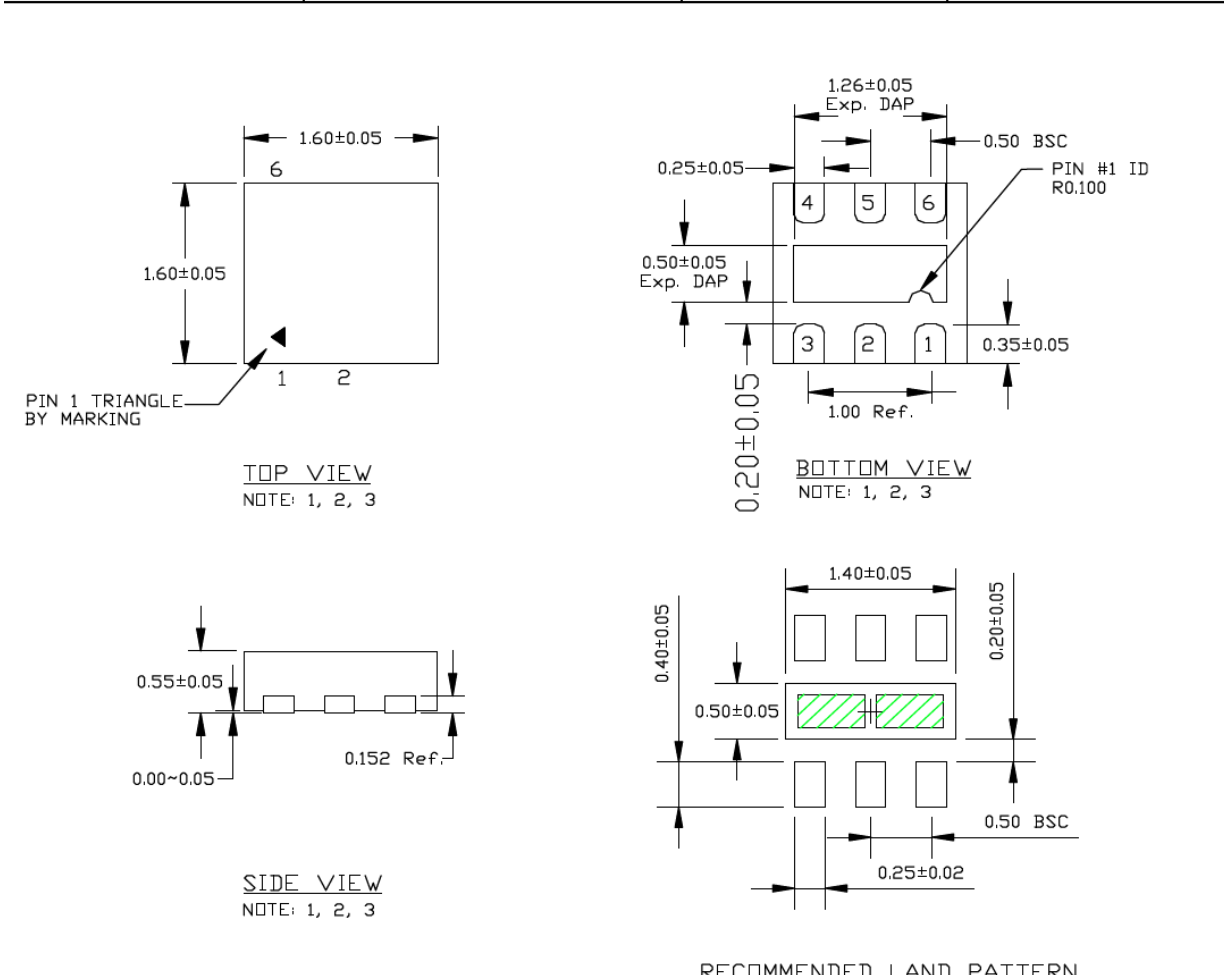

TOP VIEW
NOTE: 1, 2, 3

BOTTOM VIEW
NOTE: 1, 2, 3

SIDE VIEW
NOTE: 1, 2, 3

RECOMMENDED LAND PATTERN
NOTE: 4

- NOTE:
1. MAX PACKAGE WARPAGE IS 0.05 MM
 2. MAX ALLOWABLE BURR IS 0.076MM IN ALL DIRECTIONS
 3. PIN #1 IS ON TOP WILL BE LASER MARKED
 4. GREEN SHADED AREA REPRESENT SOLDER STENCIL OPENING (OPTIONAL) FOR IMPROVED THERMAL PERFORMANCE. SIZE: 0.55x0.30MM

Note: For the most current package drawings, please see the Microchip Packaging Specification located at <http://www.microchip.com/packaging>.

MIC5335

NOTES:

APPENDIX A: REVISION HISTORY

Revision A (June 2018)

- Converted Micrel document MIC5335 to Microchip data sheet template DS20006039A.
- Minor grammatical text changes throughout.
- Addition of MIC5335-XXYMT option in [Table 5-1](#) and [Product Identification System](#).
- Updated [Package Type](#) drawing.
- Updated [Functional Block Diagram](#) drawing.

MIC5335

NOTES:

PRODUCT IDENTIFICATION SYSTEM

To order or obtain information, e.g., on pricing or delivery, contact your local Microchip representative or sales office.

Device	-XX	X	XX	-XX
Part No.	Voltage Option	Junction Temp. Range	Package	Media Type
Device:	MIC5335:	Dual-Channel, High-Performance 300 mA μ Cap ULDO		
Voltage Option:	GF = 1.8V/1.5V GG = 1.8V/1.8V GW = 1.8V/1.6V JG = 2.5V/1.8V JJ = 2.5V/2.5V KD = 2.6V/1.85V KG = 2.6V/1.8V LL = 2.7V/2.7V MF = 2.8V/1.5V MG = 2.8V/1.8V MK = 2.8V/2.6V MM = 2.8V/2.8V ND = 2.85V/1.85V NK = 2.85V/2.6V NN = 2.85V/2.85V OF = 2.9V/1.5V OG = 2.9V/1.8V OO = 2.9V/2.9V PG = 3.0V/1.8V PJ = 3.0V/2.5V PK = 3.0V/2.6V PM = 3.0V/2.8V PN = 3.0V/2.85V PP = 3.0V/3.0V SF = 3.3V/1.5V SG = 3.3V/1.8V SJ = 3.3V/2.5V SK = 3.3V/2.6V SL = 3.3V/2.7V SM = 3.3V/2.8V SN = 3.3V/2.85V SO = 3.3V/2.9V SP = 3.3V/3.0V SR = 3.3V/3.2V SS = 3.3V/3.3V XX = 3.15V/3.15V			
Junction Temperature Range:	Y	=	-40°C to +125°C, RoHS-Compliant	
Package:	MT	=	6-Lead 1.6 mm x 1.6 mm TDFN	
Media Type:	TR	=	5,000/Reel	
Examples:				
a) MIC5335-GFYMT-TR: MIC5335, 1.8V/1.5V Voltage Option, -40°C to +125°C Temperature Range, 6-Lead 1.6 mm x 1.6 mm TDFN, 5,000/Reel				
b) MIC5335-JJYMT-TR: MIC5335, 2.5V/2.5V Voltage Option, -40°C to +125°C Temperature Range, 6-Lead 1.6 mm x 1.6 mm TDFN, 5,000/Reel				
c) MIC5335-MKYMT-TR: MIC5335, 2.8V/2.6V Voltage Option, -40°C to +125°C Temperature Range, 6-Lead 1.6 mm x 1.6 mm TDFN, 5,000/Reel				
d) MIC5335-OGYMT-TR: MIC5335, 2.9V/1.8V Voltage Option, -40°C to +125°C Temperature Range, 6-Lead 1.6 mm x 1.6 mm TDFN, 5,000/Reel				
e) MIC5335-PJYMT-TR: MIC5335, 3.0V/2.5V Voltage Option, -40°C to +125°C Temperature Range, 6-Lead 1.6 mm x 1.6 mm TDFN, 5,000/Reel				
f) MIC5335-SGYMT-TR: MIC5335, 3.3V/1.8V Voltage Option, -40°C to +125°C Temperature Range, 6-Lead 1.6 mm x 1.6 mm TDFN, 5,000/Reel				
g) MIC5335-SRYMT-TR: MIC5335, 3.3V/3.2V Voltage Option, -40°C to +125°C Temperature Range, 6-Lead 1.6 mm x 1.6 mm TDFN, 5,000/Reel				
h) MIC5335-XXYMT-TR: MIC5335, 3.15V/3.15V Voltage Option, -40°C to +125°C Temperature Range, 6-Lead 1.6 mm x 1.6 mm TDFN, 5,000/Reel				
Note 1: Tape and Reel identifier only appears in the catalog part number description. This identifier is used for ordering purposes and is not printed on the device package. Check with your Microchip Sales Office for package availability with the Tape and Reel option.				

MIC5335

NOTES:

Note the following details of the code protection feature on Microchip devices:

- Microchip products meet the specification contained in their particular Microchip Data Sheet.
- Microchip believes that its family of products is one of the most secure families of its kind on the market today, when used in the intended manner and under normal conditions.
- There are dishonest and possibly illegal methods used to breach the code protection feature. All of these methods, to our knowledge, require using the Microchip products in a manner outside the operating specifications contained in Microchip's Data Sheets. Most likely, the person doing so is engaged in theft of intellectual property.
- Microchip is willing to work with the customer who is concerned about the integrity of their code.
- Neither Microchip nor any other semiconductor manufacturer can guarantee the security of their code. Code protection does not mean that we are guaranteeing the product as “unbreakable.”

Code protection is constantly evolving. We at Microchip are committed to continuously improving the code protection features of our products. Attempts to break Microchip's code protection feature may be a violation of the Digital Millennium Copyright Act. If such acts allow unauthorized access to your software or other copyrighted work, you may have a right to sue for relief under that Act.

Information contained in this publication regarding device applications and the like is provided only for your convenience and may be superseded by updates. It is your responsibility to ensure that your application meets with your specifications. MICROCHIP MAKES NO REPRESENTATIONS OR WARRANTIES OF ANY KIND WHETHER EXPRESS OR IMPLIED, WRITTEN OR ORAL, STATUTORY OR OTHERWISE, RELATED TO THE INFORMATION, INCLUDING BUT NOT LIMITED TO ITS CONDITION, QUALITY, PERFORMANCE, MERCHANTABILITY OR FITNESS FOR PURPOSE. Microchip disclaims all liability arising from this information and its use. Use of Microchip devices in life support and/or safety applications is entirely at the buyer's risk, and the buyer agrees to defend, indemnify and hold harmless Microchip from any and all damages, claims, suits, or expenses resulting from such use. No licenses are conveyed, implicitly or otherwise, under any Microchip intellectual property rights unless otherwise stated.

Microchip received ISO/TS-16949:2009 certification for its worldwide headquarters, design and wafer fabrication facilities in Chandler and Tempe, Arizona; Gresham, Oregon and design centers in California and India. The Company's quality system processes and procedures are for its PIC® MCUs and dsPIC® DSCs, KEELoC® code hopping devices, Serial EEPROMs, microperipherals, nonvolatile memory and analog products. In addition, Microchip's quality system for the design and manufacture of development systems is ISO 9001:2000 certified.

**QUALITY MANAGEMENT SYSTEM
CERTIFIED BY DNV
= ISO/TS 16949 =**

Trademarks

The Microchip name and logo, the Microchip logo, AnyRate, AVR, AVR logo, AVR Freaks, BitCloud, CryptoMemory, CryptoRF, dsPIC, FlashFlex, flexPWR, Heldo, JukeBlox, KeeLoq, Kleer, LANCheck, LINK MD, maXStylus, maXTouch, MediaLB, megaAVR, MOST, MOST logo, MPLAB, OptoLyzer, PIC, picoPower, PICSTART, PIC32 logo, Prochip Designer, QTouch, SAM-BA, SpyNIC, SST, SST Logo, SuperFlash, tinyAVR, UNI/O, and XMEGA are registered trademarks of Microchip Technology Incorporated in the U.S.A. and other countries.

ClockWorks, The Embedded Control Solutions Company, EtherSynch, Hyper Speed Control, HyperLight Load, IntelliMOS, mTouch, Precision Edge, and Quiet-Wire are registered trademarks of Microchip Technology Incorporated in the U.S.A. Adjacent Key Suppression, AKS, Analog-for-the-Digital Age, Any Capacitor, AnyIn, AnyOut, BodyCom, chipKIT, chipKIT logo, CodeGuard, CryptoAuthentication, CryptoAutomotive, CryptoCompanion, CryptoController, dsPICDEM, dsPICDEM.net, Dynamic Average Matching, DAM, ECAN, EtherGREEN, In-Circuit Serial Programming, ICSP, INICnet, Inter-Chip Connectivity, JitterBlocker, KleerNet, KleerNet logo, memBrain, Mindi, MiWi, motorBench, MPASM, MPF, MPLAB Certified logo, MPLIB, MPLINK, MultiTRAK, NetDetach, Omniscient Code Generation, PICDEM, PICDEM.net, PICkit, PICtail, PowerSmart, PureSilicon, QMatrix, REAL ICE, Ripple Blocker, SAM-ICE, Serial Quad I/O, SMART-I.S., SQI, SuperSwitcher, SuperSwitcher II, Total Endurance, TSHARC, USBCheck, VariSense, ViewSpan, WiperLock, Wireless DNA, and ZENA are trademarks of Microchip Technology Incorporated in the U.S.A. and other countries.

SQTP is a service mark of Microchip Technology Incorporated in the U.S.A.

Silicon Storage Technology is a registered trademark of Microchip Technology Inc. in other countries.

GestIC is a registered trademarks of Microchip Technology Germany II GmbH & Co. KG, a subsidiary of Microchip Technology Inc., in other countries.

All other trademarks mentioned herein are property of their respective companies.

©2018, Microchip Technology Incorporated, All Rights Reserved.

ISBN: 978-1-5224-3193-0



MICROCHIP

Worldwide Sales and Service

AMERICAS

Corporate Office
2355 West Chandler Blvd.
Chandler, AZ 85224-6199
Tel: 480-792-7200
Fax: 480-792-7277
Technical Support:
<http://www.microchip.com/support>
Web Address:
www.microchip.com

Atlanta

Duluth, GA
Tel: 678-957-9614
Fax: 678-957-1455

Austin, TX

Tel: 512-257-3370

Boston

Westborough, MA
Tel: 774-760-0087
Fax: 774-760-0088

Chicago

Itasca, IL
Tel: 630-285-0071
Fax: 630-285-0075

Dallas

Addison, TX
Tel: 972-818-7423
Fax: 972-818-2924

Detroit

Novi, MI
Tel: 248-848-4000

Houston, TX

Tel: 281-894-5983

Indianapolis

Noblesville, IN
Tel: 317-773-8323
Fax: 317-773-5453
Tel: 317-536-2380

Los Angeles

Mission Viejo, CA
Tel: 949-462-9523
Fax: 949-462-9608
Tel: 951-273-7800

Raleigh, NC

Tel: 919-844-7510

New York, NY

Tel: 631-435-6000

San Jose, CA

Tel: 408-735-9110
Tel: 408-436-4270

Canada - Toronto

Tel: 905-695-1980
Fax: 905-695-2078

ASIA/PACIFIC

Australia - Sydney
Tel: 61-2-9868-6733

China - Beijing
Tel: 86-10-8569-7000

China - Chengdu
Tel: 86-28-8665-5511

China - Chongqing
Tel: 86-23-8980-9588

China - Dongguan
Tel: 86-769-8702-9880

China - Guangzhou
Tel: 86-20-8755-8029

China - Hangzhou
Tel: 86-571-8792-8115

China - Hong Kong SAR
Tel: 852-2943-5100

China - Nanjing
Tel: 86-25-8473-2460

China - Qingdao
Tel: 86-532-8502-7355

China - Shanghai
Tel: 86-21-3326-8000

China - Shenyang
Tel: 86-24-2334-2829

China - Shenzhen
Tel: 86-755-8864-2200

China - Suzhou
Tel: 86-186-6233-1526

China - Wuhan
Tel: 86-27-5980-5300

China - Xian
Tel: 86-29-8833-7252

China - Xiamen
Tel: 86-592-2388138

China - Zhuhai
Tel: 86-756-3210040

ASIA/PACIFIC

India - Bangalore
Tel: 91-80-3090-4444

India - New Delhi
Tel: 91-11-4160-8631

India - Pune
Tel: 91-20-4121-0141

Japan - Osaka
Tel: 81-6-6152-7160

Japan - Tokyo
Tel: 81-3-6880-3770

Korea - Daegu
Tel: 82-53-744-4301

Korea - Seoul
Tel: 82-2-554-7200

Malaysia - Kuala Lumpur
Tel: 60-3-7651-7906

Malaysia - Penang
Tel: 60-4-227-8870

Philippines - Manila
Tel: 63-2-634-9065

Singapore
Tel: 65-6334-8870

Taiwan - Hsin Chu
Tel: 886-3-577-8366

Taiwan - Kaohsiung
Tel: 886-7-213-7830

Taiwan - Taipei
Tel: 886-2-2508-8600

Thailand - Bangkok
Tel: 66-2-694-1351

Vietnam - Ho Chi Minh
Tel: 84-28-5448-2100

EUROPE

Austria - Wels
Tel: 43-7242-2244-39
Fax: 43-7242-2244-393

Denmark - Copenhagen
Tel: 45-4450-2828
Fax: 45-4485-2829

Finland - Espoo
Tel: 358-9-4520-820

France - Paris
Tel: 33-1-69-53-63-20
Fax: 33-1-69-30-90-79

Germany - Garching
Tel: 49-8931-9700

Germany - Haan
Tel: 49-2129-3766400

Germany - Heilbronn
Tel: 49-7131-67-3636

Germany - Karlsruhe
Tel: 49-721-625370

Germany - Munich
Tel: 49-89-627-144-0
Fax: 49-89-627-144-44

Germany - Rosenheim
Tel: 49-8031-354-560

Israel - Ra'anana
Tel: 972-9-744-7705

Italy - Milan
Tel: 39-0331-742611
Fax: 39-0331-466781

Italy - Padova
Tel: 39-049-7625286

Netherlands - Drunen
Tel: 31-416-690399
Fax: 31-416-690340

Norway - Trondheim
Tel: 47-7289-7561

Poland - Warsaw
Tel: 48-22-3325737

Romania - Bucharest
Tel: 40-21-407-87-50

Spain - Madrid
Tel: 34-91-708-08-90
Fax: 34-91-708-08-91

Sweden - Gothenberg
Tel: 46-31-704-60-40

Sweden - Stockholm
Tel: 46-8-5090-4654

UK - Wokingham
Tel: 44-118-921-5800
Fax: 44-118-921-5820

Looking for pricing, stock, or lifecycle information?

Click below to explore more details on WIN SOURCE:

-  [View MIC5335-MGYMT-TR on WIN SOURCE](#)
-  [Microchip Technology](#) Information

Optimize Your Supply Chain with WIN SOURCE Solutions

-  Global Sourcing Solution
-  Obsolete Management
-  Cost Control Management
-  Shortage Management
-  Alternative Solution
-  Excess Inventory Management