



**THE DATASHEET OF  
BUK9612-55B,118**





# BUK9612-55B

## N-channel TrenchMOS logic level FET

Rev. 02 — 4 June 2010

Product data sheet

## 1. Product profile

### 1.1 General description

Logic level N-channel enhancement mode Field-Effect Transistor (FET) in a plastic package using TrenchMOS technology. This product has been designed and qualified to the appropriate AEC standard for use in automotive critical applications.

### 1.2 Features and benefits

- Low conduction losses due to low on-state resistance
- Q101 compliant
- Suitable for logic level gate drive sources
- Suitable for thermally demanding environments due to 175 °C rating

### 1.3 Applications

- 12 V and 24 V loads
- Automotive systems
- General purpose power switching
- Motors, lamps and solenoids

### 1.4 Quick reference data

Table 1. Quick reference data

| Symbol    | Parameter               | Conditions   | Min | Typ | Max | Unit |
|-----------|-------------------------|--|-----|-----|-----|------|
| $V_{DS}$  | drain-source voltage    | $T_j \geq 25\text{ °C}; T_j \leq 175\text{ °C}$  | -   | -   | 55  | V    |
| $I_D$     | drain current           | $V_{GS} = 5\text{ V}; T_{mb} = 25\text{ °C};$<br>see <a href="#">Figure 1</a> ; see <a href="#">Figure 3</a> | [1] | -   | 75  | A    |
| $P_{tot}$ | total power dissipation | $T_{mb} = 25\text{ °C};$ see <a href="#">Figure 2</a>  | -   | -   | 157 | W    |

#### Static characteristics

|              |                                  |   |   |      |    |    |
|--------------|----------------------------------|---|---|------|----|----|
| $R_{DS(on)}$ | drain-source on-state resistance | $V_{GS} = 10\text{ V}; I_D = 25\text{ A};$<br>$T_j = 25\text{ °C}$  | - | 9    | 10 | mΩ |
|              |                                  | $V_{GS} = 5\text{ V}; I_D = 25\text{ A};$<br>$T_j = 25\text{ °C};$<br>see <a href="#">Figure 11</a> ; see <a href="#">Figure 12</a> | - | 10.2 | 12 | mΩ |

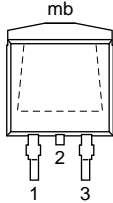
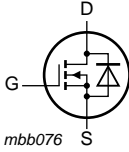
Table 1. Quick reference data ...continued

| Symbol                         | Parameter                                    | Conditions   | Min | Typ | Max | Unit |
|--------------------------------|--|--|-----|-----|-----|------|
| <b>Avalanche ruggedness</b>    |  |  |     |     |     |      |
| $E_{DS(AL)S}$                  | non-repetitive drain-source avalanche energy | $I_D = 75\text{ A}$ ; $V_{sup} \leq 55\text{ V}$ ;<br>$R_{GS} = 50\ \Omega$ ; $V_{GS} = 5\text{ V}$ ;<br>$T_{j(\text{init})} = 25\text{ }^\circ\text{C}$ ; unclamped | -   | -   | 172 | mJ   |
| <b>Dynamic characteristics</b> |  |  |     |     |     |      |
| $Q_{GD}$                       | gate-drain charge                            | $V_{GS} = 5\text{ V}$ ; $I_D = 25\text{ A}$ ;<br>$V_{DS} = 44\text{ V}$ ; $T_j = 25\text{ }^\circ\text{C}$ ;<br>see <a href="#">Figure 13</a>                        | -   | 12  | -   | nC   |

[1] Continuous current is limited by package.

## 2. Pinning information

Table 2. Pinning information

| Pin | Symbol | Description                       | Simplified outline   | Graphic symbol   |
|-----|--------|-----------------------------------|--|--|
| 1   | G      | gate                              |  |  |
| 2   | D      | drain <sup>[1]</sup>              |  |  |
| 3   | S      | source                            |  |  |
| mb  | D      | mounting base; connected to drain |  |  |

**SOT404 (D2PAK)**

[1] It is not possible to make a connection to pin 2.

## 3. Ordering information

Table 3. Ordering information

| Type number | Package |  | Version |
|-------------|---------|--|---------|
|             | Name    | Description  |         |
| BUK9612-55B | D2PAK   | plastic single-ended surface-mounted package (D2PAK); 3 leads (one lead cropped) | SOT404  |

## 4. Limiting values

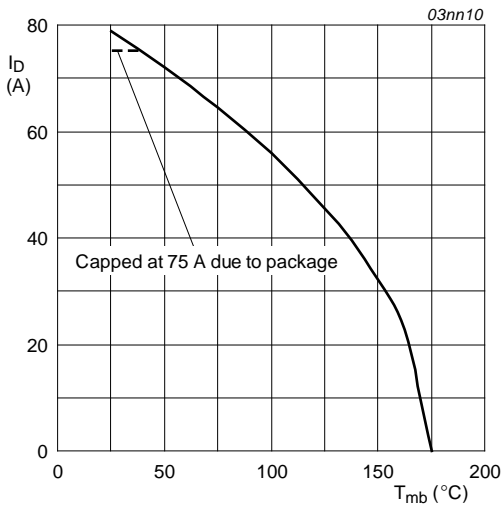
**Table 4. Limiting values**

In accordance with the Absolute Maximum Rating System (IEC 60134).

| Symbol                      | Parameter  | Conditions   | Min | Typ | Max | Unit |   |
|-----------------------------|--|--|-----|-----|-----|------|---|
| $V_{DS}$                    | drain-source voltage                               | $T_j \geq 25\text{ °C}$ ; $T_j \leq 175\text{ °C}$   | -   | -   | 55  | V    |   |
| $V_{DGR}$                   | drain-gate voltage                                 | $R_{GS} = 20\text{ k}\Omega$   | -   | -   | 55  | V    |   |
| $V_{GS}$                    | gate-source voltage                                |  | -15 | -   | 15  | V    |   |
| $I_D$                       | drain current                                      | $T_{mb} = 25\text{ °C}$ ; $V_{GS} = 5\text{ V}$ ;<br>see <a href="#">Figure 1</a> ; see <a href="#">Figure 3</a>                                     | [1] | -   | -   | 75   | A |
|                             |  |  | [2] | -   | -   | 79   | A |
|                             |  | $T_{mb} = 100\text{ °C}$ ; $V_{GS} = 5\text{ V}$ ; see <a href="#">Figure 1</a>  | [2] | -   | -   | 56   | A |
| $I_{DM}$                    | peak drain current                                 | $T_{mb} = 25\text{ °C}$ ; $t_p \leq 10\text{ }\mu\text{s}$ ; pulsed;<br>see <a href="#">Figure 3</a>   | -   | -   | 322 | A    |   |
| $P_{tot}$                   | total power dissipation                            | $T_{mb} = 25\text{ °C}$ ; see <a href="#">Figure 2</a>   | -   | -   | 157 | W    |   |
| $T_{stg}$                   | storage temperature                                |  | -55 | -   | 175 | °C   |   |
| $T_j$                       | junction temperature                               |  | -55 | -   | 175 | °C   |   |
| <b>Source-drain diode</b>   |  |  |     |     |     |      |   |
| $I_S$                       | source current                                     | $T_{mb} = 25\text{ °C}$  | [1] | -   | -   | 75   | A |
|                             |  |  | [2] | -   | -   | 79   | A |
| $I_{SM}$                    | peak source current                                | $t_p \leq 10\text{ }\mu\text{s}$ ; pulsed; $T_{mb} = 25\text{ °C}$   | -   | -   | 322 | A    |   |
| <b>Avalanche ruggedness</b> |  |  |     |     |     |      |   |
| $E_{DS(AL)S}$               | non-repetitive<br>drain-source<br>avalanche energy | $I_D = 75\text{ A}$ ; $V_{sup} \leq 55\text{ V}$ ; $R_{GS} = 50\text{ }\Omega$ ;<br>$V_{GS} = 5\text{ V}$ ; $T_{j(init)} = 25\text{ °C}$ ; unclamped | -   | -   | 172 | mJ   |   |

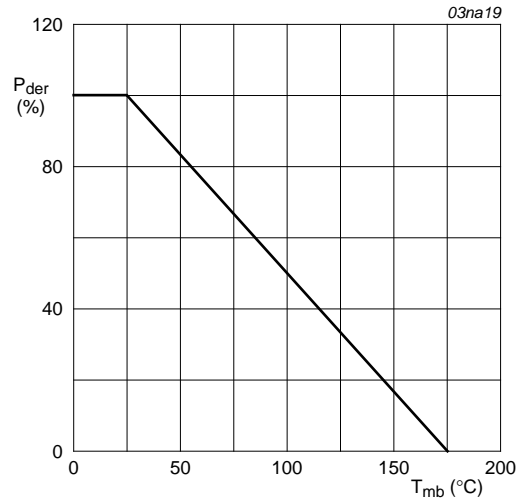
[1] Continuous current is limited by package.

[2] Current is limited by power dissipation chip rating.



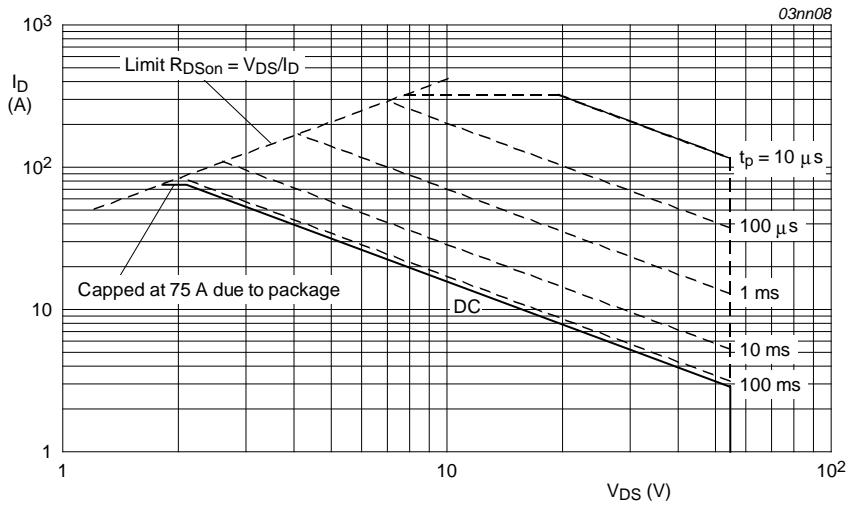
$$V_{GS} \geq 5V$$

**Fig 1. Normalized continuous drain current as a function of mounting base temperature**



$$P_{der} = \frac{P_{tot}}{P_{tot(25^{\circ}C)}} \times 100\%$$

**Fig 2. Normalized total power dissipation as a function of mounting base temperature**



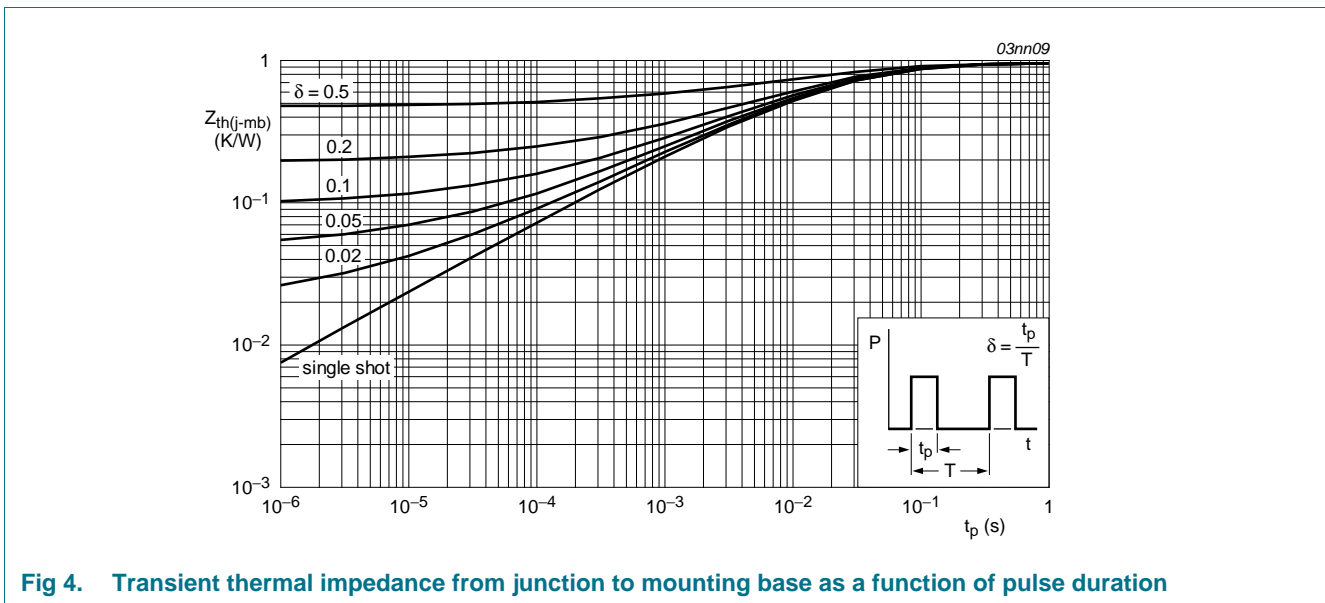
$$T_{mb} = 25^{\circ}C; I_{DM} \text{ is single pulse}$$

**Fig 3. Safe operating area; continuous and peak drain currents as a function of drain-source voltage**

## 5. Thermal characteristics

**Table 5. Thermal characteristics**

| Symbol         | Parameter   | Conditions   | Min | Typ | Max  | Unit |
|----------------|---|--|-----|-----|------|------|
| $R_{th(j-mb)}$ | thermal resistance from junction to mounting base | see <a href="#">Figure 4</a>                           | -   | -   | 0.95 | K/W  |
| $R_{th(j-a)}$  | thermal resistance from junction to ambient       | minimum footprint ; mounted on a printed-circuit board | -   | 50  | -    | K/W  |



**Fig 4. Transient thermal impedance from junction to mounting base as a function of pulse duration**

## 6. Characteristics

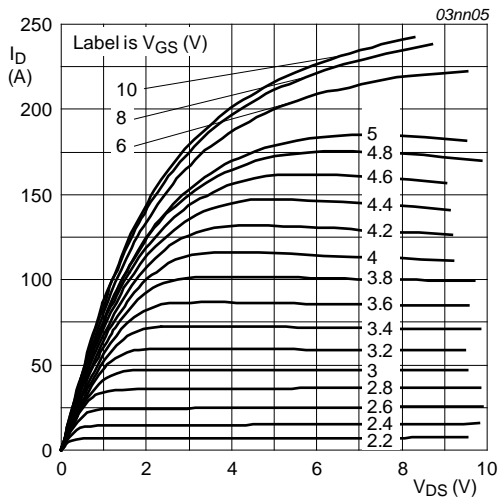
Table 6. Characteristics

| Symbol                         | Parameter                        | Conditions  | Min | Typ  | Max  | Unit          |
|--------------------------------|----------------------------------|---|-----|------|------|---------------|
| <b>Static characteristics</b>  |                                  |   |     |      |      |               |
| $V_{(BR)DSS}$                  | drain-source breakdown voltage   | $I_D = 0.25 \text{ mA}; V_{GS} = 0 \text{ V}; T_j = 25 \text{ }^\circ\text{C}$  | 55  | -    | -    | V             |
|                                |                                  | $I_D = 0.25 \text{ mA}; V_{GS} = 0 \text{ V}; T_j = -55 \text{ }^\circ\text{C}$   | 50  | -    | -    | V             |
| $V_{GS(th)}$                   | gate-source threshold voltage    | $I_D = 1 \text{ mA}; V_{DS} = V_{GS}; T_j = 175 \text{ }^\circ\text{C};$<br>see <a href="#">Figure 10</a>                                       | 0.5 | -    | -    | V             |
|                                |                                  | $I_D = 1 \text{ mA}; V_{DS} = V_{GS}; T_j = -55 \text{ }^\circ\text{C};$<br>see <a href="#">Figure 10</a>                                       | -   | -    | 2.3  | V             |
|                                |                                  | $I_D = 1 \text{ mA}; V_{DS} = V_{GS}; T_j = 25 \text{ }^\circ\text{C};$<br>see <a href="#">Figure 10</a>  | 1.1 | 1.5  | 2    | V             |
| $I_{DSS}$                      | drain leakage current            | $V_{DS} = 55 \text{ V}; V_{GS} = 0 \text{ V}; T_j = 175 \text{ }^\circ\text{C}$   | -   | -    | 500  | $\mu\text{A}$ |
|                                |                                  | $V_{DS} = 55 \text{ V}; V_{GS} = 0 \text{ V}; T_j = 25 \text{ }^\circ\text{C}$  | -   | 0.02 | 1    | $\mu\text{A}$ |
| $I_{GSS}$                      | gate leakage current             | $V_{DS} = 0 \text{ V}; V_{GS} = 15 \text{ V}; T_j = 25 \text{ }^\circ\text{C}$  | -   | 2    | 100  | nA            |
|                                |                                  | $V_{DS} = 0 \text{ V}; V_{GS} = -15 \text{ V}; T_j = 25 \text{ }^\circ\text{C}$   | -   | 2    | 100  | nA            |
| $R_{DS(on)}$                   | drain-source on-state resistance | $V_{GS} = 5 \text{ V}; I_D = 25 \text{ A}; T_j = 175 \text{ }^\circ\text{C};$<br>see <a href="#">Figure 11</a> ; see <a href="#">Figure 12</a>  | -   | -    | 24   | m $\Omega$    |
|                                |                                  | $V_{GS} = 4.5 \text{ V}; I_D = 25 \text{ A}; T_j = 25 \text{ }^\circ\text{C}$   | -   | -    | 13.3 | m $\Omega$    |
|                                |                                  | $V_{GS} = 10 \text{ V}; I_D = 25 \text{ A}; T_j = 25 \text{ }^\circ\text{C}$  | -   | 9    | 10   | m $\Omega$    |
|                                |                                  | $V_{GS} = 5 \text{ V}; I_D = 25 \text{ A}; T_j = 25 \text{ }^\circ\text{C};$<br>see <a href="#">Figure 11</a> ; see <a href="#">Figure 12</a>   | -   | 10.2 | 12   | m $\Omega$    |
| <b>Dynamic characteristics</b> |                                  |   |     |      |      |               |
| $Q_{G(tot)}$                   | total gate charge                | $I_D = 25 \text{ A}; V_{DS} = 44 \text{ V}; V_{GS} = 5 \text{ V};$<br>$T_j = 25 \text{ }^\circ\text{C};$ see <a href="#">Figure 13</a>          | -   | 31   | -    | nC            |
| $Q_{GS}$                       | gate-source charge               |   | -   | 6    | -    | nC            |
| $Q_{GD}$                       | gate-drain charge                |   | -   | 12   | -    | nC            |
| $C_{iss}$                      | input capacitance                | $V_{GS} = 0 \text{ V}; V_{DS} = 25 \text{ V}; f = 1 \text{ MHz};$<br>$T_j = 25 \text{ }^\circ\text{C};$ see <a href="#">Figure 14</a>           | -   | 2770 | 3693 | pF            |
| $C_{oss}$                      | output capacitance               |   | -   | 360  | 431  | pF            |
| $C_{rss}$                      | reverse transfer capacitance     |   | -   | 160  | 220  | pF            |
| $t_{d(on)}$                    | turn-on delay time               | $V_{DS} = 30 \text{ V}; R_L = 1.2 \text{ } \Omega; V_{GS} = 5 \text{ V};$<br>$R_{G(ext)} = 10 \text{ } \Omega; T_j = 25 \text{ }^\circ\text{C}$ | -   | 19   | -    | ns            |
| $t_r$                          | rise time                        |   | -   | 101  | -    | ns            |
| $t_{d(off)}$                   | turn-off delay time              |   | -   | 96   | -    | ns            |
| $t_f$                          | fall time                        |   | -   | 75   | -    | ns            |
| $L_D$                          | internal drain inductance        | from upper edge of drain mounting base<br>to centre of die ; $T_j = 25 \text{ }^\circ\text{C}$  | -   | 2.5  | -    | nH            |
|                                |                                  | from drain lead 6 mm from package to<br>centre of die ; $T_j = 25 \text{ }^\circ\text{C}$   | -   | 4.5  | -    | nH            |
| $L_S$                          | internal source inductance       | from source lead 6 mm from package to<br>source bond pad ; $T_j = 25 \text{ }^\circ\text{C}$  | -   | 7.5  | -    | nH            |

### Source-drain diode

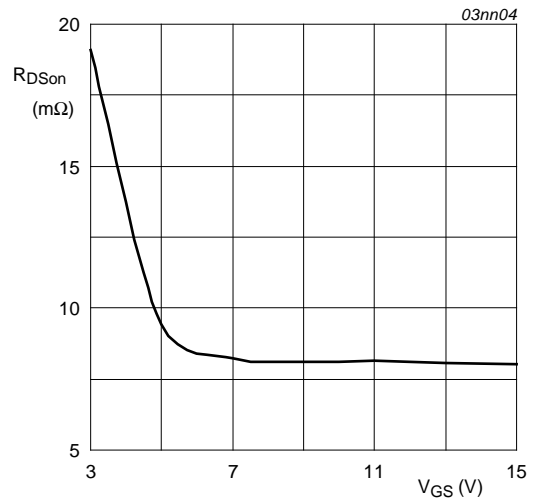
**Table 6. Characteristics ...continued**

| Symbol   | Parameter             | Conditions  | Min | Typ  | Max | Unit |
|----------|-----------------------|---|-----|------|-----|------|
| $V_{SD}$ | source-drain voltage  | $I_S = 25\text{ A}$ ; $V_{GS} = 0\text{ V}$ ; $T_j = 25\text{ }^\circ\text{C}$ ;<br>see <a href="#">Figure 15</a> | -   | 0.85 | 1.2 | V    |
| $t_{rr}$ | reverse recovery time | $I_S = 20\text{ A}$ ; $di_S/dt = -100\text{ A}/\mu\text{s}$ ;   | -   | 55   | -   | ns   |
| $Q_r$    | recovered charge      | $V_{GS} = -10\text{ V}$ ; $V_{DS} = 30\text{ V}$ ; $T_j = 25\text{ }^\circ\text{C}$                               | -   | 53   | -   | nC   |



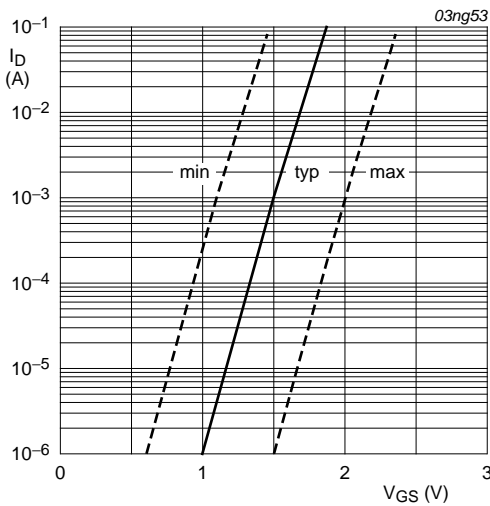
$T_j = 25\text{ }^\circ\text{C}$ ;  $t_p = 300\mu\text{s}$

**Fig 5. Output characteristics: drain current as a function of drain-source voltage; typical values**



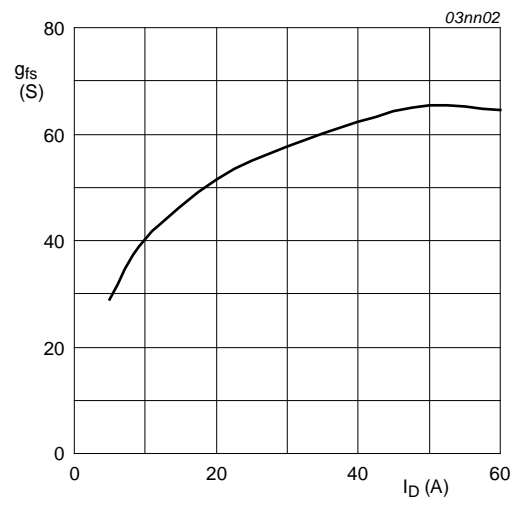
$T_j = 25\text{ }^\circ\text{C}$ ;  $I_D = 25\text{ A}$

**Fig 6. Drain-source on-state resistance as a function of gate-source voltage; typical values**



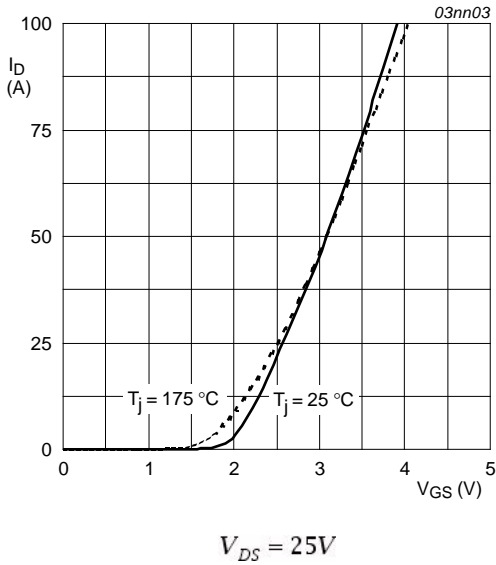
$T_j = 25\text{ }^\circ\text{C}$ ;  $V_{DS} = V_{GS}$

**Fig 7. Sub-threshold drain current as a function of gate-source voltage**

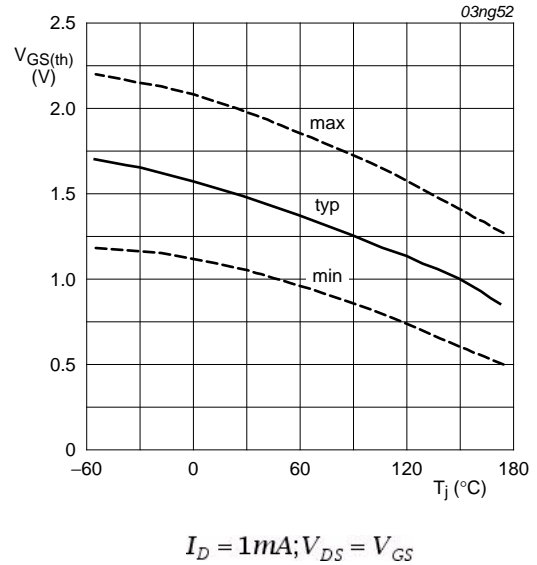


$T_j = 25\text{ }^\circ\text{C}$ ;  $V_{DS} = 25\text{ V}$

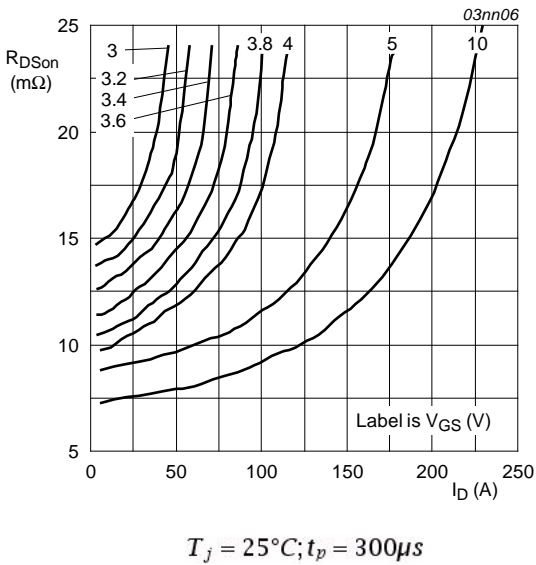
**Fig 8. Forward transconductance as a function of drain current; typical values**



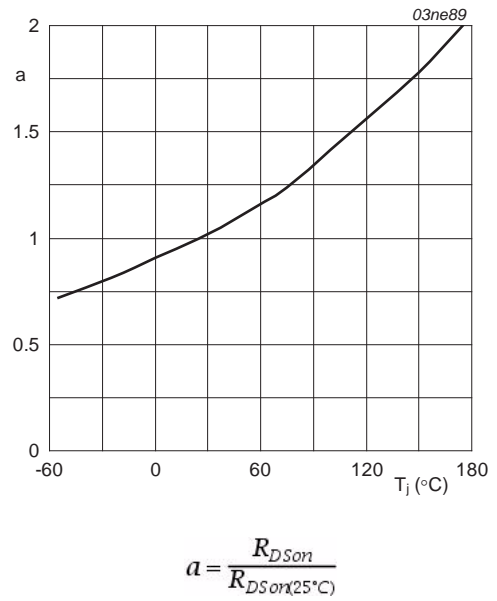
**Fig 9. Transfer characteristics: drain current as a function of gate-source voltage; typical values**



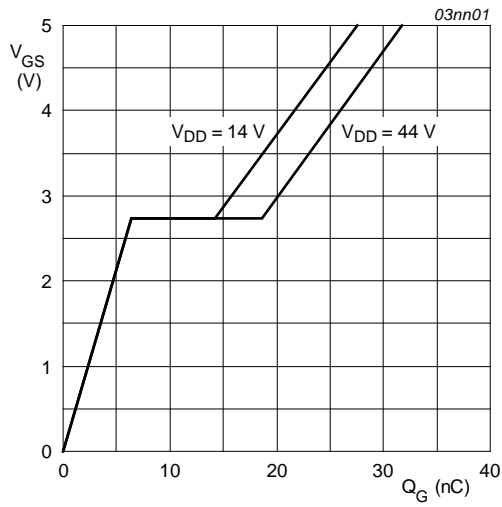
**Fig 10. Gate-source threshold voltage as a function of junction temperature**



**Fig 11. Drain-source on-state resistance as a function of drain current; typical values**

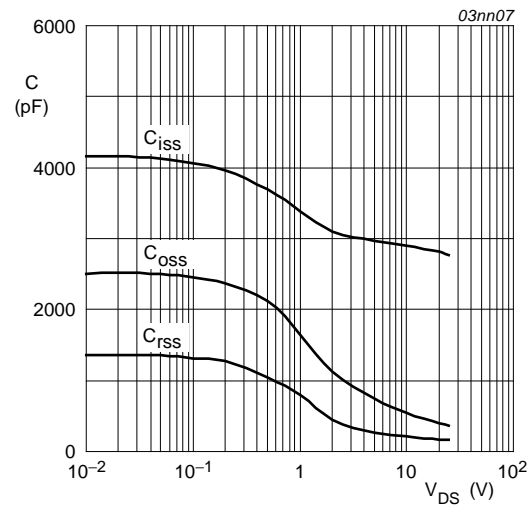


**Fig 12. Normalized drain-source on-state resistance factor as a function of junction temperature**



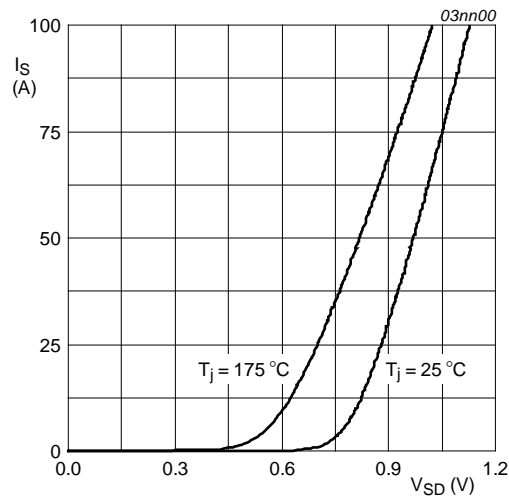
$T_j = 25^\circ\text{C}; I_D = 25\text{A}$

**Fig 13. Gate-source voltage as a function of gate charge; typical values**



$V_{GS} = 0\text{V}; f = 1\text{MHz}$

**Fig 14. Input, output and reverse transfer capacitances as a function of drain-source voltage; typical values**



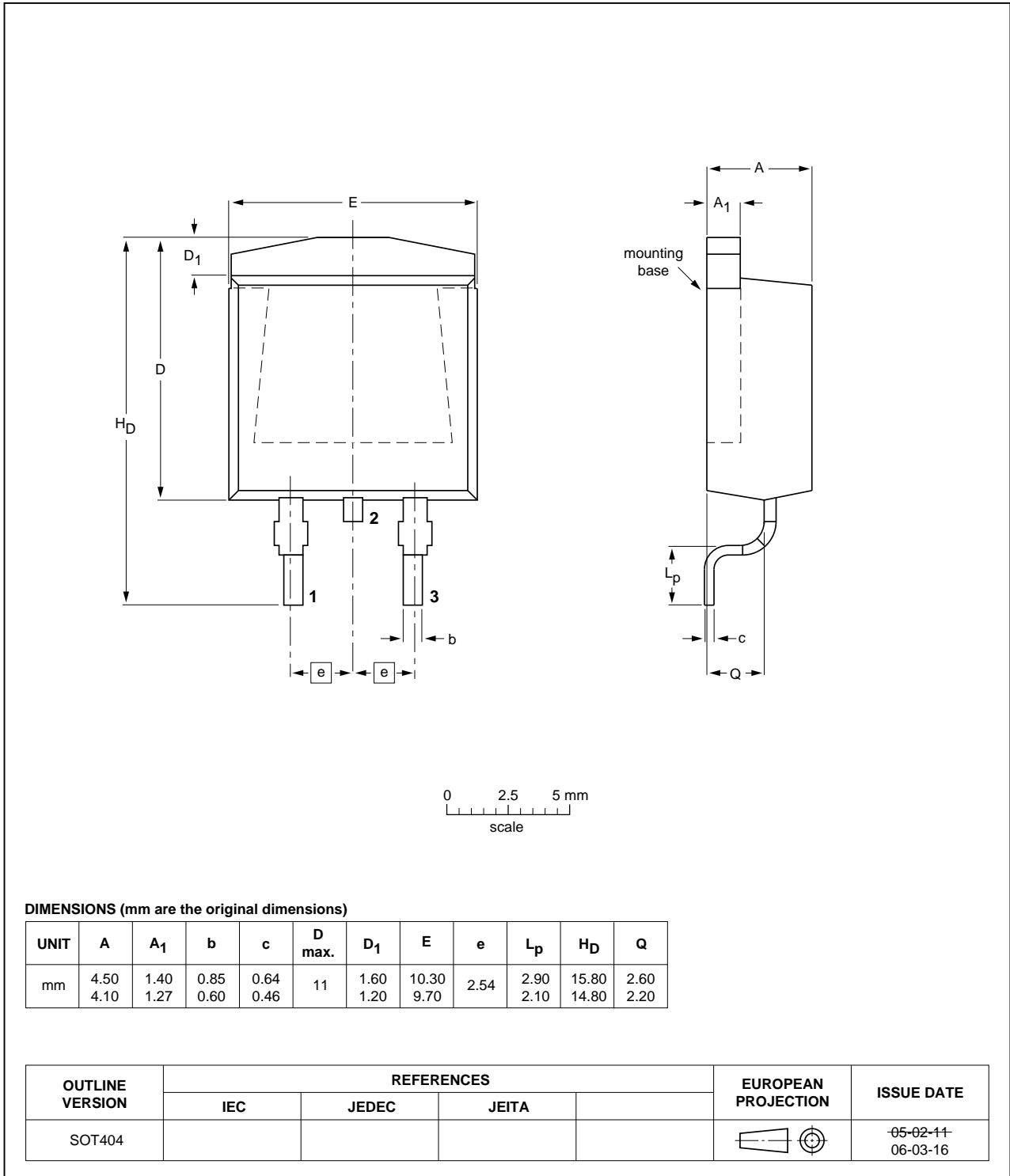
$V_{GS} = 0\text{V}$

**Fig 15. Source current as a function of source-drain voltage; typical values**

**7. Package outline**

Plastic single-ended surface-mounted package (D2PAK); 3 leads (one lead cropped)

**SOT404**



**Fig 16. Package outline SOT404 (D2PAK)**

## 8. Revision history

Table 7. Revision history

| Document ID                           | Release date | Data sheet status  | Change notice | Supersedes  |
|---------------------------------------|--------------|--------------------|---------------|---|
| BUK9612-55B v.2                       | 20100604     | Product data sheet | -             | BUK95_9612_55B-01   |
| Modifications:                        |              |                    |               |   |
|                                       |              |                    |               | <ul style="list-style-type: none"><li>• The format of this data sheet has been redesigned to comply with the new identity guidelines of NXP Semiconductors.</li><li>• Legal texts have been adapted to the new company name where appropriate.</li><li>• Type number BUK9612-55B separated from data sheet BUK95_9612_55B-01.</li></ul> |
| BUK95_9612_55B-01<br>(9397 750 11247) | 20030428     | Product data       | -             | -   |

## 9. Legal information

### 9.1 Data sheet status

| Document status <sup>[1][2]</sup> | Product status <sup>[3]</sup> | Definition  |
|-----------------------------------|-------------------------------|---|
| Objective [short] data sheet      | Development                   | This document contains data from the objective specification for product development. |
| Preliminary [short] data sheet    | Qualification                 | This document contains data from the preliminary specification.                       |
| Product [short] data sheet        | Production                    | This document contains the product specification.                                     |

[1] Please consult the most recently issued document before initiating or completing a design.

[2] The term 'short data sheet' is explained in section "Definitions".

[3] The product status of device(s) described in this document may have changed since this document was published and may differ in case of multiple devices. The latest product status information is available on the Internet at URL <http://www.nexperia.com>.

### 9.2 Definitions

**Draft** — The document is a draft version only. The content is still under internal review and subject to formal approval, which may result in modifications or additions. Nexperia does not give any representations or warranties as to the accuracy or completeness of information included herein and shall have no liability for the consequences of use of such information.

**Short data sheet** — A short data sheet is an extract from a full data sheet with the same product type number(s) and title. A short data sheet is intended for quick reference only and should not be relied upon to contain detailed and full information. For detailed and full information see the relevant full data sheet, which is available on request via the local Nexperia sales office. In case of any inconsistency or conflict with the short data sheet, the full data sheet shall prevail.

**Product specification** — The information and data provided in a Product data sheet shall define the specification of the product as agreed between Nexperia and its customer, unless Nexperia and customer have explicitly agreed otherwise in writing. In no event however, shall an agreement be valid in which the Nexperia product is deemed to offer functions and qualities beyond those described in the Product data sheet.

### 9.3 Disclaimers

**Limited warranty and liability** — Information in this document is believed to be accurate and reliable. However, Nexperia does not give any representations or warranties, expressed or implied, as to the accuracy or completeness of such information and shall have no liability for the consequences of use of such information.

In no event shall Nexperia be liable for any indirect, incidental, punitive, special or consequential damages (including - without limitation - lost profits, lost savings, business interruption, costs related to the removal or replacement of any products or rework charges) whether or not such damages are based on tort (including negligence), warranty, breach of contract or any other legal theory.

Notwithstanding any damages that customer might incur for any reason whatsoever, Nexperia's aggregate and cumulative liability towards customer for the products described herein shall be limited in accordance with the *Terms and conditions of commercial sale* of Nexperia.

**Right to make changes** — Nexperia reserves the right to make changes to information published in this document, including without limitation specifications and product descriptions, at any time and without notice. This document supersedes and replaces all information supplied prior to the publication hereof.

**Suitability for use in automotive applications** — This Nexperia product has been qualified for use in automotive applications. The product is not designed, authorized or warranted to be suitable for use in medical, military, aircraft, space or life support equipment, nor in applications where failure or malfunction of a Nexperia product can reasonably be expected to result in personal injury, death or severe property or environmental damage. Nexperia accepts no liability for inclusion and/or use of Nexperia products in such equipment or applications and therefore such inclusion and/or use is at the customer's own risk.

**Applications** — Applications that are described herein for any of these products are for illustrative purposes only. Nexperia makes no representation or warranty that such applications will be suitable for the specified use without further testing or modification.

Nexperia does not accept any liability related to any default, damage, costs or problem which is based on a weakness or default in the customer application/use or the application/use of customer's third party customer(s) (hereinafter both referred to as "Application"). It is customer's sole responsibility to check whether the Nexperia product is suitable and fit for the Application planned. Customer has to do all necessary testing for the Application in order to avoid a default of the Application and the product. Nexperia does not accept any liability in this respect.

**Quick reference data** — The Quick reference data is an extract of the product data given in the Limiting values and Characteristics sections of this document, and as such is not complete, exhaustive or legally binding. **Limiting values** — Stress above one or more limiting values (as defined in the Absolute Maximum Ratings System of IEC 60134) will cause permanent damage to the device. Limiting values are stress ratings only and (proper) operation of the device at these or any other conditions above those given in the Recommended operating conditions section (if present) or the Characteristics sections of this document is not warranted. Constant or repeated exposure to limiting values will permanently and irreversibly affect the quality and reliability of the device.

**Terms and conditions of commercial sale** — Nexperia products are sold subject to the general terms and conditions of commercial sale, as published at <http://www.nexperia.com/profile/terms>, unless otherwise agreed in a valid written individual agreement. In case an individual agreement is concluded only the terms and conditions of the respective agreement shall apply. Nexperia hereby expressly objects to applying the customer's general terms and conditions with regard to the purchase of Nexperia products by customer.

**No offer to sell or license** — Nothing in this document may be interpreted or construed as an offer to sell products that is open for acceptance or the grant, conveyance or implication of any license under any copyrights, patents or other industrial or intellectual property rights.

**Export control** — This document as well as the item(s) described herein may be subject to export control regulations. Export might require a prior authorization from national authorities.

## 10. Contact information

---

For more information, please visit: <http://www.nexperia.com>

For sales office addresses, please send an email to: [salesaddresses@nexperia.com](mailto:salesaddresses@nexperia.com)



## 11. Contents

---

|           |  |           |
|-----------|--|-----------|
| <b>1</b>  | <b>Product profile</b> . . . . .         | <b>1</b>  |
| 1.1       | General description . . . . .            | 1         |
| 1.2       | Features and benefits . . . . .          | 1         |
| 1.3       | Applications . . . . .                   | 1         |
| 1.4       | Quick reference data . . . . .           | 1         |
| <b>2</b>  | <b>Pinning information</b> . . . . .     | <b>2</b>  |
| <b>3</b>  | <b>Ordering information</b> . . . . .    | <b>2</b>  |
| <b>4</b>  | <b>Limiting values</b> . . . . .         | <b>3</b>  |
| <b>5</b>  | <b>Thermal characteristics</b> . . . . . | <b>5</b>  |
| <b>6</b>  | <b>Characteristics</b> . . . . .         | <b>6</b>  |
| <b>7</b>  | <b>Package outline</b> . . . . .         | <b>10</b> |
| <b>8</b>  | <b>Revision history</b> . . . . .        | <b>11</b> |
| <b>9</b>  | <b>Legal information</b> . . . . .       | <b>12</b> |
| 9.1       | Data sheet status . . . . .              | 12        |
| 9.2       | Definitions . . . . .                    | 12        |
| 9.3       | Disclaimers . . . . .                    | 12        |
| 9.4       | Trademarks . . . . .                     | 13        |
| <b>10</b> | <b>Contact information</b> . . . . .     | <b>13</b> |

## Looking for pricing, stock, or lifecycle information?

Click below to explore more details on WIN SOURCE:

-  [View BUK9612-55B,118 on WIN SOURCE](#)
-  [Nexperia USA Inc. Information](#)

## Optimize Your Supply Chain with WIN SOURCE Solutions

-  Global Sourcing Solution
-  Obsolete Management
-  Cost Control Management
-  Shortage Management
-  Alternative Solution
-  Excess Inventory Management