

# CPH6442



ON Semiconductor®

www.onsemi.com

## Power MOSFET 60V, 43mΩ, 6A, Single N-Channel

### Features

- 4V Drive
- Low On-Resistance
- ESD Diode-Protected Gate
- Pb-Free, and RoHS Compliance
- Halogen Free Compliance : CPH6442-TL-W

### Specifications

**Absolute Maximum Ratings** at Ta = 25°C

Parameter	Symbol	Value	Unit
Drain to Source Voltage	V <sub>DSS</sub>	60	V
Gate to Source Voltage	V <sub>GSS</sub>	±20	V
Drain Current (DC)	I <sub>D</sub>	6	A
Drain Current (Pulse) PW≤10μs, duty cycle≤1%	I <sub>DP</sub>	24	A
Power Dissipation When mounted on ceramic substrate (900mm <sup>2</sup> × 0.8mm)	P <sub>D</sub>	1.6	W
Junction Temperature	T <sub>J</sub>	150	°C
Storage Temperature	T <sub>stg</sub>	-55 to +150	°C

### Thermal Resistance Ratings

Parameter	Symbol	Value	Unit
Junction to Ambient When mounted on ceramic substrate (900mm <sup>2</sup> × 0.8mm)	R <sub>θJA</sub>	78.1	°C/W

V <sub>DSS</sub>	R <sub>DS(on) Max</sub>	I <sub>D</sub> Max
60V	43 mΩ@10V	6A
	59 mΩ@4.5V	
	65 mΩ@4V	

### Electrical Connection N-Channel

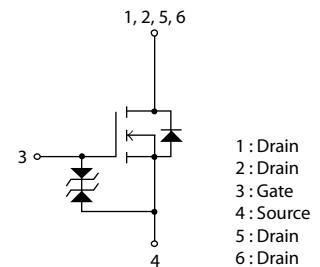

### Packing Type : TL

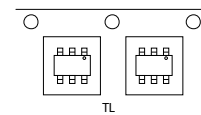

### Marking

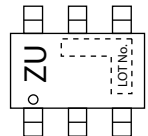

Stresses exceeding those listed in the Maximum Ratings table may damage the device. If any of these limits are exceeded, device functionality should not be assumed, damage may occur and reliability may be affected.

### ORDERING INFORMATION

See detailed ordering and shipping information on page 5 of this data sheet.

# CPH6442

## Electrical Characteristics at $T_a = 25^\circ\text{C}$

Parameter	Symbol	Conditions	Value			Unit
			min	typ	max	
Drain to Source Breakdown Voltage	$V_{(BR)DSS}$	$I_D=1\text{mA}, V_{GS}=0\text{V}$	60			V
Zero-Gate Voltage Drain Current	$I_{DSS}$	$V_{DS}=60\text{V}, V_{GS}=0\text{V}$			1	$\mu\text{A}$
Gate to Source Leakage Current	$I_{GSS}$	$V_{GS}=\pm 16\text{V}, V_{DS}=0\text{V}$			$\pm 10$	$\mu\text{A}$
Gate Threshold Voltage	$V_{GS(th)}$	$V_{DS}=10\text{V}, I_D=1\text{mA}$	1.2		2.6	V
Forward Transconductance	$g_{FS}$	$V_{DS}=10\text{V}, I_D=3\text{A}$	2.6	4.4		S
Static Drain to Source On-State Resistance	$R_{DS(on)1}$	$I_D=3\text{A}, V_{GS}=10\text{V}$		33	43	$\text{m}\Omega$
	$R_{DS(on)2}$	$I_D=1.5\text{A}, V_{GS}=4.5\text{V}$		42	59	$\text{m}\Omega$
	$R_{DS(on)3}$	$I_D=1.5\text{A}, V_{GS}=4\text{V}$		46	65	$\text{m}\Omega$
Input Capacitance	$C_{iss}$	$V_{DS}=20\text{V}, f=1\text{MHz}$		1040		pF
Output Capacitance	$C_{oss}$			90		pF
Reverse Transfer Capacitance	$C_{rss}$			55		pF
Turn-ON Delay Time	$t_{d(on)}$	See specified Test Circuit		12		ns
Rise Time	$t_r$			18		ns
Turn-OFF Delay Time	$t_{d(off)}$			80		ns
Fall Time	$t_f$			35		ns
Total Gate Charge	$Q_g$		$V_{DS}=30\text{V}, V_{GS}=10\text{V}, I_D=6\text{A}$		20	
Gate to Source Charge	$Q_{gs}$			3.0		nC
Gate to Drain "Miller" Charge	$Q_{gd}$			4.2		nC
Forward Diode Voltage	$V_{SD}$	$I_S=6\text{A}, V_{GS}=0\text{V}$		0.82	1.2	V

Product parametric performance is indicated in the Electrical Characteristics for the listed test conditions, unless otherwise noted. Product performance may not be indicated by the Electrical Characteristics if operated under different conditions.

## Switching Time Test Circuit

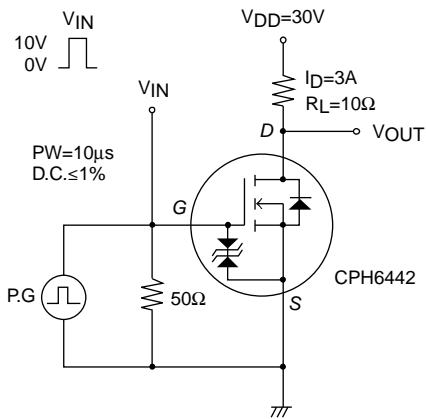

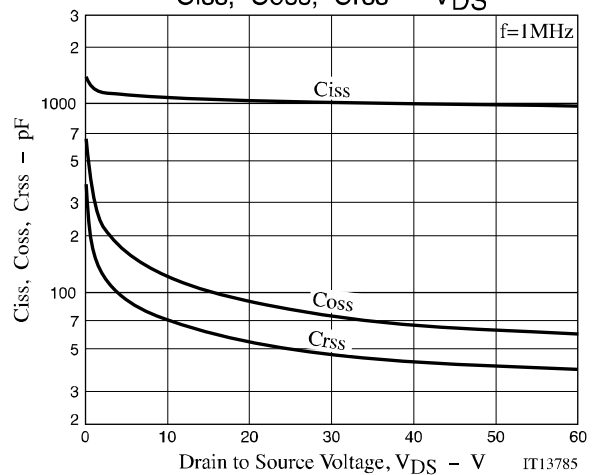
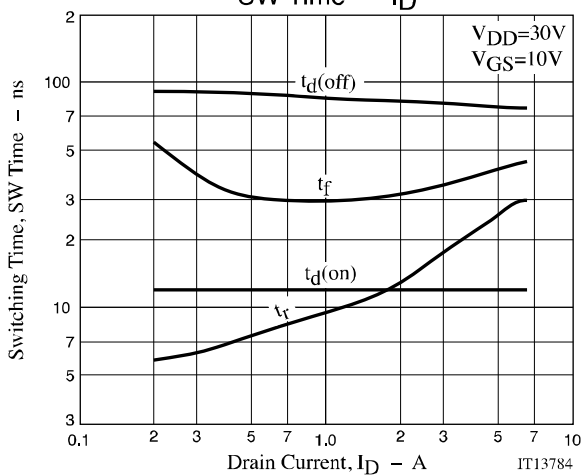
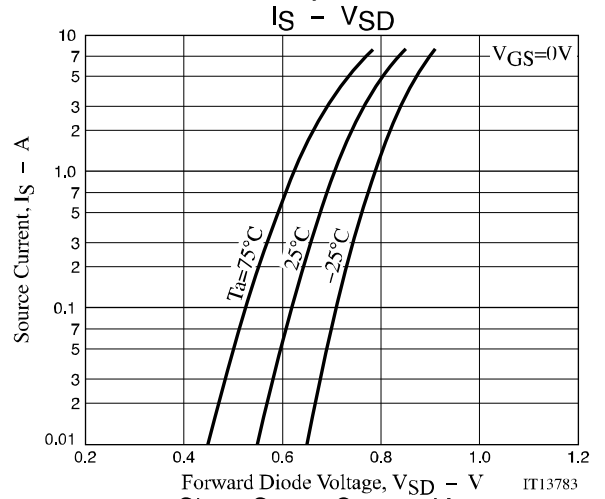
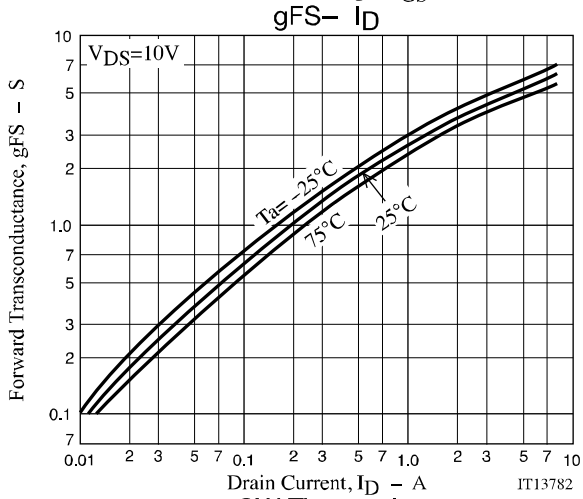
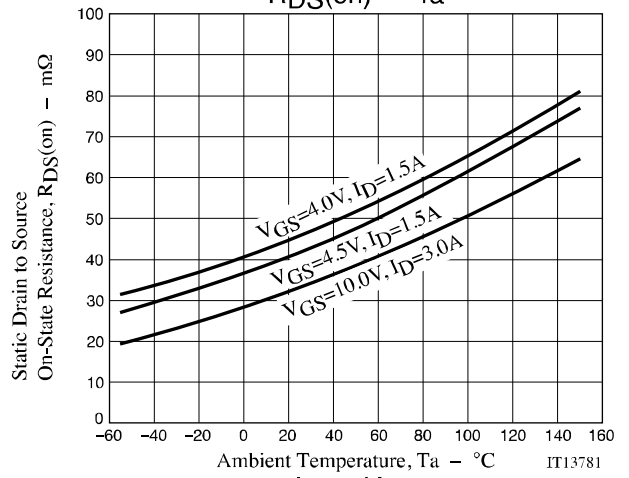
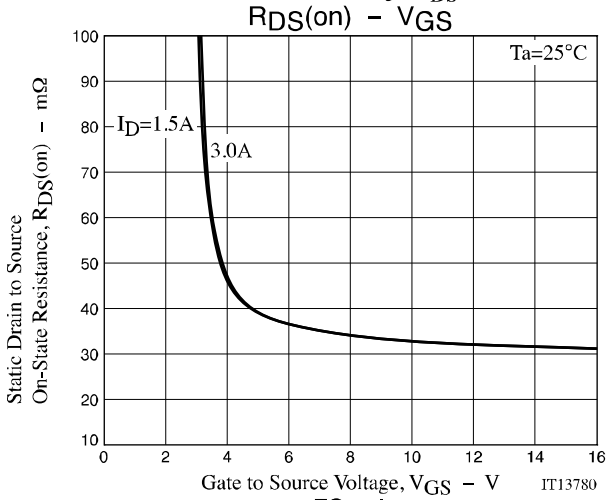
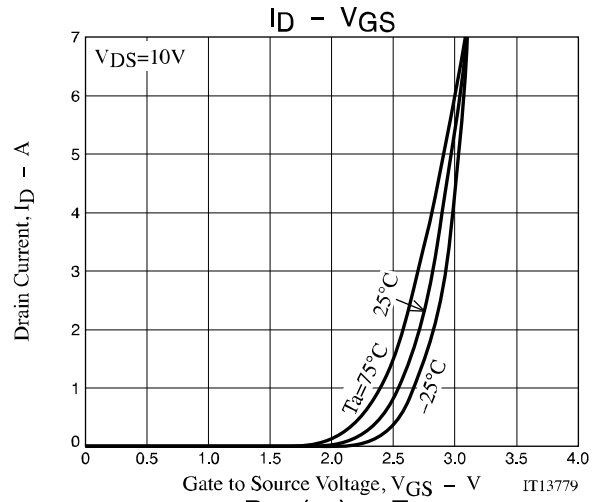
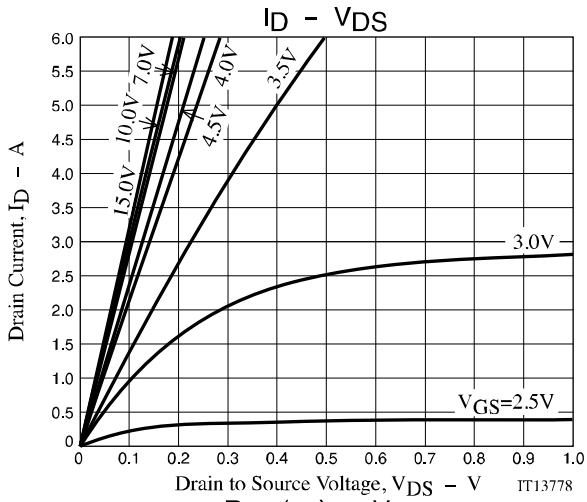

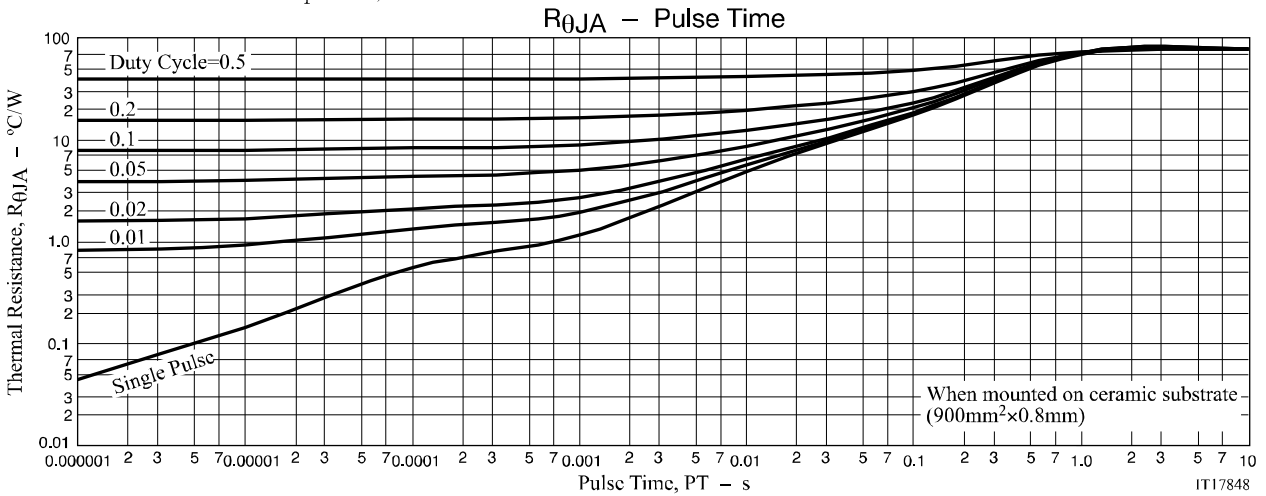
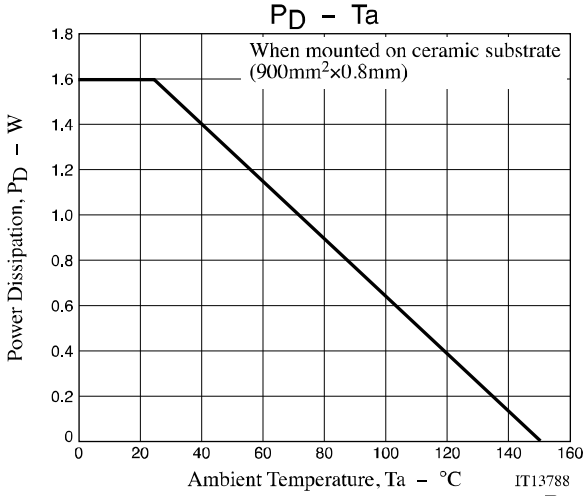
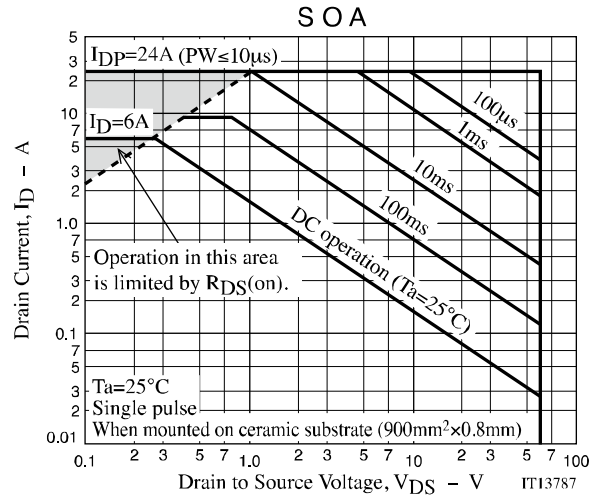
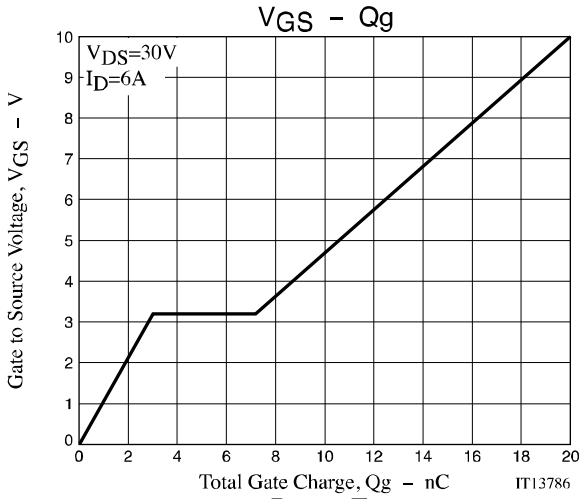



## Looking for pricing, stock, or lifecycle information?

Click below to explore more details on WIN SOURCE:

- ⊖ [View CPH6442-TL-E on WIN SOURCE](#)
- ⊖ [ON Semiconductor](#) Information

## Optimize Your Supply Chain with WIN SOURCE Solutions

- ✓ Global Sourcing Solution
- ✓ Obsolete Management
- ✓ Cost Control Management
- ✓ Shortage Management
- ✓ Alternative Solution
- ✓ Excess Inventory Management