



**THE DATASHEET OF  
LM285LPR-2-5**



## LMx85-2.5, LM385B-2.5 Micropower Voltage References

### 1 Features

- Operating Current Range 20  $\mu$ A to 20 mA
- 1.5% and 3% Initial Voltage Tolerance
- Reference Impedance
  - LM385 1  $\Omega$  Maximum at 25°C
  - All Devices 1.5  $\Omega$  Maximum Over Full Temperature Range
- Very Low Power Consumption

### 2 Applications

- Portable Meter References
- Portable Test Instruments
- Battery-Operated Systems
- Current-Loop Instrumentation
- Panel Meters

### 3 Description

The LMx85-2.5 and LM385B are micropower, two-terminal, band-gap voltage references that operate over a 20- $\mu$ A to 20-mA current range and feature exceptionally low dynamic impedance and good temperature stability. On-chip trimming provides tight voltage tolerance. The band-gap reference for these devices has low noise and long-term stability.

The design makes these devices exceptionally tolerant of capacitive loading and, thus, easier to use in most reference applications. The wide dynamic operating temperature range accommodates varying current supplies, with excellent regulation.

The extremely low power drain of this series makes these devices useful for micropower circuitry. These voltage references can be used to make portable meters, regulators, or general-purpose analog circuitry, with battery life approaching shelf life. The wide operating current range of these voltage references allows them to replace older references with tighter-tolerance parts.

#### Device Information<sup>(1)</sup>

PART NUMBER	PACKAGE	BODY SIZE (NOM)
LMx85D-2-5, LM385BD-2-5	SOIC (8)	4.90 mm x 3.90 mm
LMx85LP-2-5, LM385BLP-2-5	TO-92 (3)	4.30 mm x 4.30 mm
LM385PW-2-5, LM385BPW-2-5	TSSOP (8)	3.00 mm x 4.40 mm

(1) For all available packages, see the orderable addendum at the end of the data sheet.

#### Simplified Schematic



## Table of Contents

<b>1 Features</b> .....	<b>1</b>	<b>8 Application and Implementation</b> .....	<b>9</b>
<b>2 Applications</b> .....	<b>1</b>	8.1 Application Information.....	9
<b>3 Description</b> .....	<b>1</b>	8.2 Typical Application .....	9
<b>4 Revision History</b> .....	<b>2</b>	8.3 System Examples .....	10
<b>5 Pin Configuration and Functions</b> .....	<b>3</b>	<b>9 Power Supply Recommendations</b> .....	<b>11</b>
<b>6 Specifications</b> .....	<b>4</b>	<b>10 Layout</b> .....	<b>11</b>
6.1 Absolute Maximum Ratings .....	4	10.1 Layout Guidelines .....	11
6.2 ESD Ratings.....	4	10.2 Layout Example .....	11
6.3 Recommended Operating Conditions.....	4	<b>11 Device and Documentation Support</b> .....	<b>12</b>
6.4 Thermal Information .....	4	11.1 Related Links .....	12
6.5 Electrical Characteristics.....	5	11.2 Receiving Notification of Documentation Updates	12
6.6 Typical Characteristics .....	6	11.3 Community Resources.....	12
<b>7 Detailed Description</b> .....	<b>8</b>	11.4 Trademarks .....	12
7.1 Overview .....	8	11.5 Electrostatic Discharge Caution.....	12
7.2 Functional Block Diagram .....	8	11.6 Glossary .....	12
7.3 Feature Description.....	8	<b>12 Mechanical, Packaging, and Orderable</b>	<b>12</b>
7.4 Device Functional Modes.....	8	<b>Information</b> .....	<b>12</b>

## 4 Revision History

### Changes from Revision K (March 2016) to Revision L Page

- Changed ANODE pin description from: Shunt Current/Voltage input to: Common pin, normally connected to ground..... **3**
- Changed CATHODE pin description from: Common pin, normally connected to ground to: Shunt Current/Voltage input ... **3**

### Changes from Revision J (March 2005) to Revision K Page

- Added *Features* section, *Device Information* table, *Table of Contents*, *Revision History* section, *Pin Configuration and Functions* section, *Specifications* section, *Absolute Maximum Ratings* table, *ESD Ratings* table, *Thermal Information* table, *Detailed Description* section, *Application and Implementation* section, *Power Supply Recommendations* section, *Layout* section, *Device and Documentation Support* section, and *Mechanical, Packaging, and Orderable Information* section .....

## 5 Pin Configuration and Functions

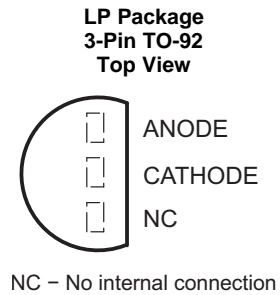
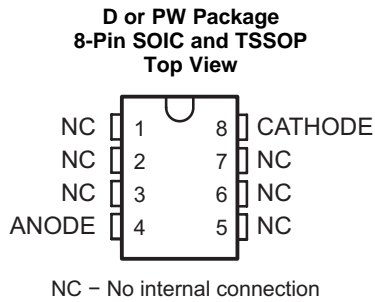

### Pin Functions

NAME	PIN			TYPE	DESCRIPTION
	NO.				
	SOIC	TSSOP	TO-92		
ANODE	4		1	I	Common pin, typically connected to ground
CATHODE	8		2	O	Shunt Current/Voltage Input
NC	1, 2, 3, 5, 6, 7			—	No Internal Connection

## 6 Specifications

### 6.1 Absolute Maximum Ratings

over operating free-air temperature range (unless otherwise noted)<sup>(1)</sup>

		MIN	MAX	UNIT
$I_R$	Reverse current		30	mA
$I_F$	Forward current		10	mA
	Lead temperature 1.6 mm (1/16 inch) from case for 10 seconds		260	°C
$T_J$	Junction temperature		150	°C
$T_{stg}$	Storage temperature	-65	150	°C

(1) Stresses beyond those listed under *Absolute Maximum Ratings* may cause permanent damage to the device. These are stress ratings only, which do not imply functional operation of the device at these or any other conditions beyond those indicated under *Recommended Operating Conditions*. Exposure to absolute-maximum-rated conditions for extended periods may affect device reliability.

### 6.2 ESD Ratings

		VALUE	UNIT
$V_{(ESD)}$	Electrostatic discharge	Human-body model (HBM), per ANSI/ESDA/JEDEC JS-001 <sup>(1)</sup>	±2000
		Charged-device model (CDM), per JEDEC specification JESD22-C101 <sup>(2)</sup>	±1000

(1) JEDEC document JEP155 states that 500-V HBM allows safe manufacturing with a standard ESD control process.

(2) JEDEC document JEP157 states that 250-V CDM allows safe manufacturing with a standard ESD control process

### 6.3 Recommended Operating Conditions

over operating free-air temperature range (unless otherwise noted)

		MIN	MAX	UNIT
$I_Z$	Reference current	0.02	20	mA
$T_A$	Operating free-air temperature	LM285-2.5	-40	85
		LM385-2.5, LM385B-2.5	0	70

### 6.4 Thermal Information

THERMAL METRIC <sup>(1)</sup>	LMx85-2.5, LM385B-2.5			UNIT	
	D (SOIC)	LP (T0-92)	PW (TSSOP)		
	8 PINS	3 PINS	8 PINS		
$R_{\theta JA}$	Junction-to-ambient thermal resistance	112	157	168.3	°C/W
$R_{\theta JC(top)}$	Junction-to-case (top) thermal resistance	58.5	80.3	53.7	°C/W
$R_{\theta JB}$	Junction-to-board thermal resistance	52.1	N/A	96.4	°C/W
$\Psi_{JT}$	Junction-to-top characterization parameter	15.8	24.6	4.5	°C/W
$\Psi_{JB}$	Junction-to-board characterization parameter	51.7	136.2	94.7	°C/W

(1) For more information about traditional and new thermal metrics, see the *IC Package Thermal Metrics* (SPRA953) application report.

## 6.5 Electrical Characteristics

$T_A = 25^\circ\text{C}$  unless otherwise noted.

PARAMETER		TEST CONDITIONS		MIN	TYP	MAX	UNIT
<b>LM285-2.5</b>							
$V_Z$	Reference voltage	$I_Z = 20\ \mu\text{A}$ to 20 mA		2.462	2.5	2.538	V
$^{\alpha}V_Z$	Average temperature coefficient of reference voltage <sup>(1)</sup>	$I_Z = 20\ \mu\text{A}$ to 20 mA	Full range <sup>(2)</sup>		$\pm 20$		ppm/ $^\circ\text{C}$
$\Delta V_Z$	Change in reference voltage with current	$I_Z = 20\ \mu\text{A}$ to 1 mA	$T_A = 25^\circ\text{C}$			1	mV
			Full range			1.5	
		$I_Z = 1\ \text{mA}$ to 20 mA	$T_A = 25^\circ\text{C}$			10	
			Full range			30	
$\Delta V_Z/\Delta t$	Long-term change in reference voltage	$I_Z = 100\ \mu\text{A}$			$\pm 20$		ppm/khr
$I_{Z(\text{MIN})}$	Minimum reference current	Full range			8	20	$\mu\text{A}$
$z_z$	Reference impedance	$I_Z = 100\ \mu\text{A}$	$T_A = 25^\circ\text{C}$		0.2	0.6	$\Omega$
			Full range			1.5	
$V_n$	Broadband noise voltage	$I_Z = 100\ \mu\text{A}$ , $f = 10\ \text{Hz}$ to 10 kHz			120		$\mu\text{V}$
<b>LM385-2.5</b>							
$V_Z$	Reference voltage	$I_Z = 20\ \mu\text{A}$ to 20 mA		2.425	2.5	2.575	V
$^{\alpha}V_Z$	Average temperature coefficient of reference voltage <sup>(1)</sup>	$I_Z = 20\ \mu\text{A}$ to 20 mA	Full range <sup>(2)</sup>		$\pm 20$		ppm/ $^\circ\text{C}$
$\Delta V_Z$	Change in reference voltage with current	$I_Z = 20\ \mu\text{A}$ to 1 mA	$T_A = 25^\circ\text{C}$			2	mV
			Full range			2	
		$I_Z = 1\ \text{mA}$ to 20 mA	$T_A = 25^\circ\text{C}$			20	
			Full range			30	
$\Delta V_Z/\Delta t$	Long-term change in reference voltage	$I_Z = 100\ \mu\text{A}$			$\pm 20$		ppm/khr
$I_{Z(\text{MIN})}$	Minimum reference current	Full range			8	20	$\mu\text{A}$
$z_z$	Reference impedance	$I_Z = 100\ \mu\text{A}$	$T_A = 25^\circ\text{C}$		0.4	1	$\Omega$
			Full range			1.5	
$V_n$	Broadband noise voltage	$I_Z = 100\ \mu\text{A}$ , $f = 10\ \text{Hz}$ to 10 kHz			120		$\mu\text{V}$
<b>LM385B-2.5</b>							
$V_Z$	Reference voltage	$I_Z = 20\ \mu\text{A}$ to 20 mA		2.462	2.5	2.538	V
$^{\alpha}V_Z$	Average temperature coefficient of reference voltage <sup>(1)</sup>	$I_Z = 20\ \mu\text{A}$ to 20 mA	Full range <sup>(2)</sup>		$\pm 20$		ppm/ $^\circ\text{C}$
$\Delta V_Z$	Change in reference voltage with current	$I_Z = 20\ \mu\text{A}$ to 1 mA	$T_A = 25^\circ\text{C}$			2	mV
			Full range			2	
		$I_Z = 1\ \text{mA}$ to 20 mA	$T_A = 25^\circ\text{C}$			20	
			Full range			30	
$\Delta V_Z/\Delta t$	Long-term change in reference voltage	$I_Z = 100\ \mu\text{A}$			$\pm 20$		ppm/khr
$I_{Z(\text{MIN})}$	Minimum reference current	Full range			8	20	$\mu\text{A}$
$z_z$	Reference impedance	$I_Z = 100\ \mu\text{A}$	$T_A = 25^\circ\text{C}$		0.4	1	$\Omega$
			Full range			1.5	
$V_n$	Broadband noise voltage	$I_Z = 100\ \mu\text{A}$ , $f = 10\ \text{Hz}$ to 10 kHz			120		$\mu\text{V}$

(1) The average temperature coefficient of reference voltage is defined as the total change in reference voltage divided by the specified temperature range.

(2) Full range is  $0^\circ\text{C}$  to  $70^\circ\text{C}$  for the LM385-2.5 and LM385B-2.5, and  $-40^\circ\text{C}$  to  $85^\circ\text{C}$  for the LM285-2.5.

## 6.6 Typical Characteristics

Data at high and low temperatures are applicable only within the rated operating free-air temperature ranges of the various devices. For conditions shown as MIN or MAX, use the appropriate value specified under recommended operating conditions.

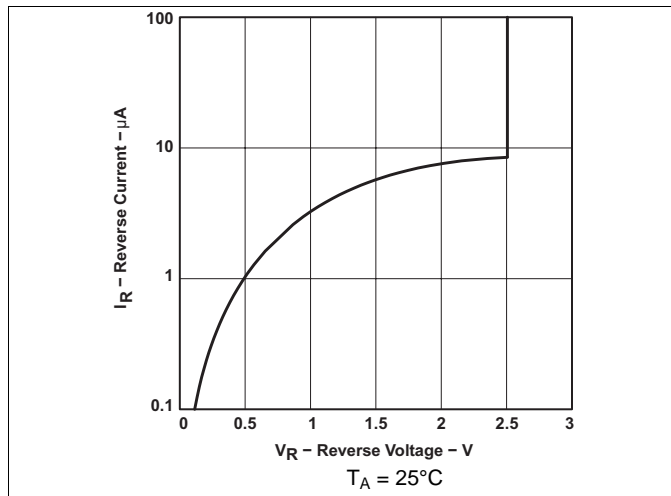

Figure 1. Reverse Current vs Reverse Voltage

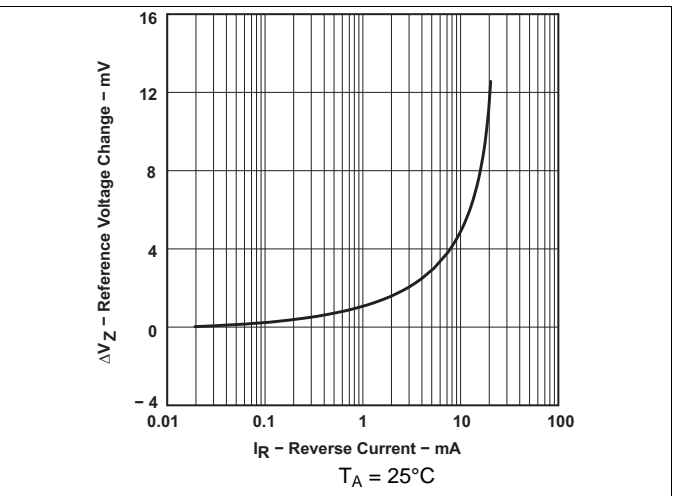

Figure 2. Reference Voltage Change vs Reverse Current

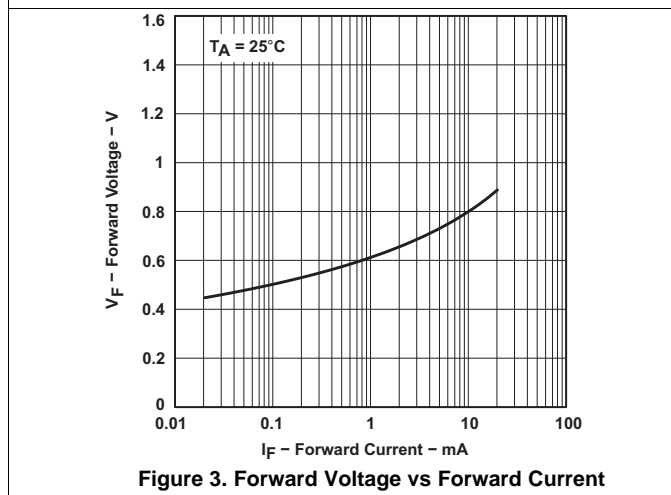

Figure 3. Forward Voltage vs Forward Current

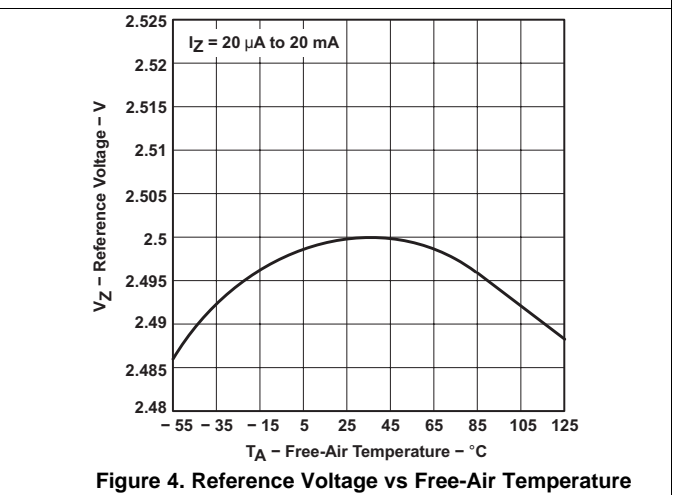

Figure 4. Reference Voltage vs Free-Air Temperature

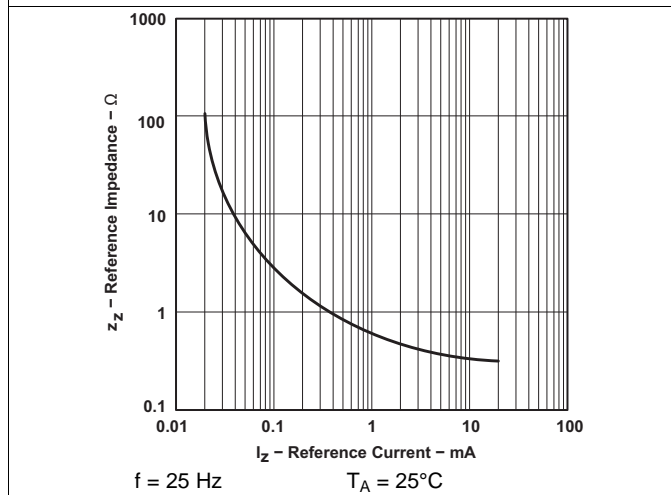

Figure 5. Reference Impedance vs Reference Current

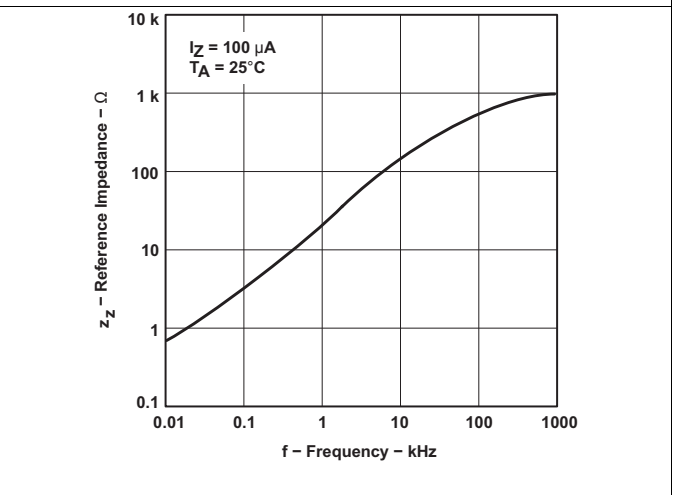
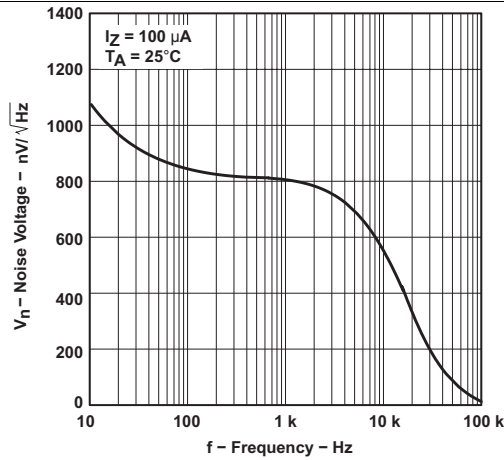

Figure 6. Reference Impedance vs Frequency

**Typical Characteristics (continued)**

Data at high and low temperatures are applicable only within the rated operating free-air temperature ranges of the various devices. For conditions shown as MIN or MAX, use the appropriate value specified under recommended operating conditions.



**Figure 7. Noise Voltage vs Frequency**

## 7 Detailed Description

### 7.1 Overview

The LMx85-2.5 and LM385B-2.5 devices maintain a nearly constant voltage between the cathode and anode of 2.5 V when the minimum cathode current up to the recommended maximum is provided. See [Recommended Operating Conditions](#) for recommended minimum cathode current.

### 7.2 Functional Block Diagram

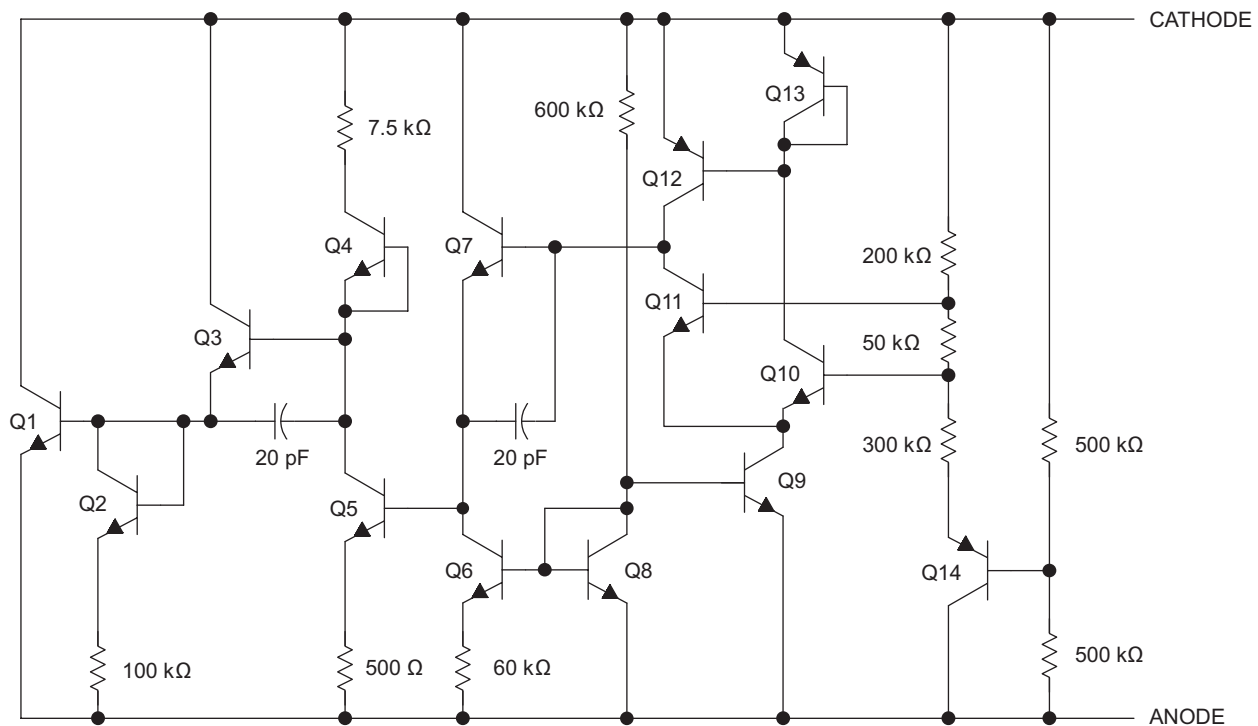

### 7.3 Feature Description

A band-gap voltage reference controls a high-gain amplifier and shunt pass element to maintain a nearly constant voltage between the cathode and anode of 2.5 V. Regulation occurs after a minimum current is provided to power the voltage divider and amplifier. Internal frequency compensation provides a stable loop for all capacitive loads. Floating shunt design is useful for both positive and negative regulation applications.

### 7.4 Device Functional Modes

The LMx85-2.5 and LM385B-2.5 devices have a single functional mode. These devices can be used as 2.5-V fixed voltage references. The reference voltage cannot be adjusted for these devices.

For a proper Reverse Voltage to be developed, current must be sourced into the cathode of LM285. The minimum current needed for proper regulation is denoted in [Electrical Characteristics](#) as  $I_{Z(MIN)}$ .

## 8 Application and Implementation

### NOTE

Information in the following applications sections is not part of the TI component specification, and TI does not warrant its accuracy or completeness. TI's customers are responsible for determining suitability of components for their purposes. Customers should validate and test their design implementation to confirm system functionality.

### 8.1 Application Information

The LMx85-2.5 and LM385B-2.5 devices create a voltage reference for use in a variety of applications including amplifiers, power supplies, and current-sensing circuits.

### 8.2 Typical Application

Figure 8 shows how to use these devices to establish a 2.5-V source from a 9-V battery.

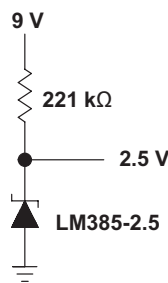

Figure 8. Reference From a 9-V Battery

#### 8.2.1 Design Requirements

The key design requirement when using this device as a voltage reference is to supply the LM385 with a minimum Cathode Current ( $I_Z$ ), as indicated in [Electrical Characteristics](#).

#### 8.2.2 Detailed Design Procedure

To generate a constant and stable reference voltage, a current greater than  $I_{Z(MIN)}$  must be sourced into the cathode of this device. This can be accomplished using a current regulating device such as LM334 or a simple resistor. For a resistor, its value should be equal to or greater than  $(V_{supply} - V_{reference}) \div I_{Z(MIN)}$ .

#### 8.2.3 Application Curve

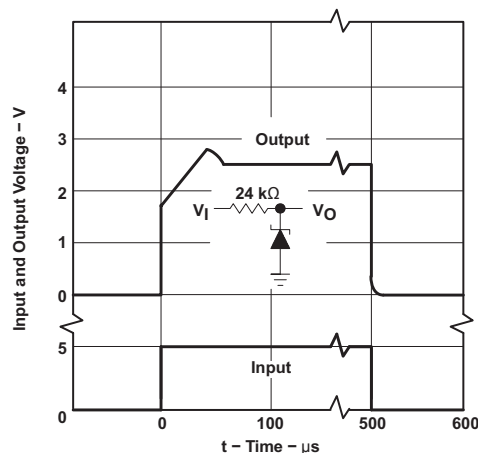

Figure 9. Device Transient Response



## 9 Power Supply Recommendations

The supply voltage should be current limited to ensure that the maximum cathode current is not exceeded.

For applications shunting high currents (30 mA maximum), pay attention to the cathode and anode trace lengths, and adjust the width of the traces to have the proper current density.

## 10 Layout

### 10.1 Layout Guidelines

Figure 12 shows an example of a PCB layout of LMx85x-2.5. Some key  $V_{ref}$  noise considerations are:

- It is optional to connect a low-ESR, 0.1- $\mu$ F ( $C_L$ ) ceramic bypass capacitor on the cathode pin node.
- Decouple other active devices in the system per the device specifications.
- Using a solid ground plane helps distribute heat and reduces electromagnetic interference (EMI) noise pickup.
- Place the external components as close to the device as possible. This configuration prevents parasitic errors (such as the Seebeck effect) from occurring.
- Do not run sensitive analog traces in parallel with digital traces. Avoid crossing digital and analog traces if possible and only make perpendicular crossings when absolutely necessary.

### 10.2 Layout Example

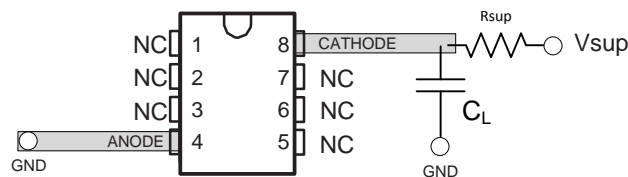

**Figure 12. Layout Diagram**

## 11 Device and Documentation Support

### 11.1 Related Links

The table below lists quick access links. Categories include technical documents, support and community resources, tools and software, and quick access to sample or buy.

**Table 1. Related Links**

PARTS	PRODUCT FOLDER	SAMPLE & BUY	TECHNICAL DOCUMENTS	TOOLS & SOFTWARE	SUPPORT & COMMUNITY
LM285-2.5	<a href="#">Click here</a>	<a href="#">Click here</a>	<a href="#">Click here</a>	<a href="#">Click here</a>	<a href="#">Click here</a>
LM385-2.5	<a href="#">Click here</a>	<a href="#">Click here</a>	<a href="#">Click here</a>	<a href="#">Click here</a>	<a href="#">Click here</a>
LM385B-2.5	<a href="#">Click here</a>	<a href="#">Click here</a>	<a href="#">Click here</a>	<a href="#">Click here</a>	<a href="#">Click here</a>

### 11.2 Receiving Notification of Documentation Updates

To receive notification of documentation updates, navigate to the device product folder on ti.com. In the upper right corner, click on *Alert me* to register and receive a weekly digest of any product information that has changed. For change details, review the revision history included in any revised document.

### 11.3 Community Resources

The following links connect to TI community resources. Linked contents are provided "AS IS" by the respective contributors. They do not constitute TI specifications and do not necessarily reflect TI's views; see TI's [Terms of Use](#).

**TI E2E™ Online Community** *TI's Engineer-to-Engineer (E2E) Community*. Created to foster collaboration among engineers. At e2e.ti.com, you can ask questions, share knowledge, explore ideas and help solve problems with fellow engineers.

**Design Support** *TI's Design Support* Quickly find helpful E2E forums along with design support tools and contact information for technical support.

### 11.4 Trademarks

E2E is a trademark of Texas Instruments.  
All other trademarks are the property of their respective owners.

### 11.5 Electrostatic Discharge Caution



These devices have limited built-in ESD protection. The leads should be shorted together or the device placed in conductive foam during storage or handling to prevent electrostatic damage to the MOS gates.

### 11.6 Glossary

[SLYZ022](#) — *TI Glossary*.

This glossary lists and explains terms, acronyms, and definitions.

## 12 Mechanical, Packaging, and Orderable Information

The following pages include mechanical, packaging, and orderable information. This information is the most current data available for the designated devices. This data is subject to change without notice and revision of this document. For browser-based versions of this data sheet, refer to the left-hand navigation.

**PACKAGING INFORMATION**

Orderable Device	Status (1)	Package Type	Package Drawing	Pins	Package Qty	Eco Plan (2)	Lead/Ball Finish (6)	MSL Peak Temp (3)	Op Temp (°C)	Device Marking (4/5)	Samples
LM285D-2-5	ACTIVE	SOIC	D	8	75	Green (RoHS & no Sb/Br)	CU NIPDAU	Level-1-260C-UNLIM	-40 to 85	285-25	<a href="#">Samples</a>
LM285DG4-2-5	ACTIVE	SOIC	D	8	75	Green (RoHS & no Sb/Br)	CU NIPDAU	Level-1-260C-UNLIM	-40 to 85	285-25	<a href="#">Samples</a>
LM285DR-2-5	ACTIVE	SOIC	D	8	2500	Green (RoHS & no Sb/Br)	CU NIPDAU	Level-1-260C-UNLIM	-40 to 85	285-25	<a href="#">Samples</a>
LM285DRG4-2-5	ACTIVE	SOIC	D	8	2500	Green (RoHS & no Sb/Br)	CU NIPDAU	Level-1-260C-UNLIM	-40 to 85	285-25	<a href="#">Samples</a>
LM285LP-2-5	ACTIVE	TO-92	LP	3	1000	Pb-Free (RoHS)	CU SN	N / A for Pkg Type	-40 to 85	285-25	<a href="#">Samples</a>
LM285LPE3-2-5	ACTIVE	TO-92	LP	3	1000	Pb-Free (RoHS)	CU SN	N / A for Pkg Type	-40 to 85	285-25	<a href="#">Samples</a>
LM285LPR-2-5	ACTIVE	TO-92	LP	3	2000	Pb-Free (RoHS)	CU SN	N / A for Pkg Type	-40 to 85	285-25	<a href="#">Samples</a>
LM285LPRE3-2-5	ACTIVE	TO-92	LP	3	2000	Pb-Free (RoHS)	CU SN	N / A for Pkg Type	-40 to 85	285-25	<a href="#">Samples</a>
LM385BD-2-5	ACTIVE	SOIC	D	8	75	Green (RoHS & no Sb/Br)	CU NIPDAU	Level-1-260C-UNLIM	0 to 70	385B25	<a href="#">Samples</a>
LM385BDE4-2-5	ACTIVE	SOIC	D	8	75	Green (RoHS & no Sb/Br)	CU NIPDAU	Level-1-260C-UNLIM	0 to 70	385B25	<a href="#">Samples</a>
LM385BDR-2-5	ACTIVE	SOIC	D	8	2500	Green (RoHS & no Sb/Br)	CU NIPDAU	Level-1-260C-UNLIM	0 to 70	385B25	<a href="#">Samples</a>
LM385BLP-2-5	ACTIVE	TO-92	LP	3	1000	Pb-Free (RoHS)	CU SN	N / A for Pkg Type	0 to 70	385B25	<a href="#">Samples</a>
LM385BLPE3-2-5	ACTIVE	TO-92	LP	3	1000	Pb-Free (RoHS)	CU SN	N / A for Pkg Type	0 to 70	385B25	<a href="#">Samples</a>
LM385BLPR-2-5	ACTIVE	TO-92	LP	3	2000	Pb-Free (RoHS)	CU SN	N / A for Pkg Type	0 to 70	385B25	<a href="#">Samples</a>
LM385BPWR-2-5	ACTIVE	TSSOP	PW	8	2000	Green (RoHS & no Sb/Br)	CU NIPDAU	Level-1-260C-UNLIM	0 to 70	385B25	<a href="#">Samples</a>
LM385D-2-5	ACTIVE	SOIC	D	8	75	Green (RoHS & no Sb/Br)	CU NIPDAU	Level-1-260C-UNLIM	0 to 70	385-25	<a href="#">Samples</a>
LM385DR-2-5	ACTIVE	SOIC	D	8	2500	Green (RoHS & no Sb/Br)	CU NIPDAU	Level-1-260C-UNLIM	0 to 70	385-25	<a href="#">Samples</a>

Orderable Device	Status (1)	Package Type	Package Drawing	Pins	Package Qty	Eco Plan (2)	Lead/Ball Finish (6)	MSL Peak Temp (3)	Op Temp (°C)	Device Marking (4/5)	Samples
LM385DRG4-2-5	ACTIVE	SOIC	D	8	2500	Green (RoHS & no Sb/Br)	CU NIPDAU	Level-1-260C-UNLIM	0 to 70	385-25	<a href="#">Samples</a>
LM385LP-2-5	ACTIVE	TO-92	LP	3	1000	Pb-Free (RoHS)	CU SN	N / A for Pkg Type	0 to 70	385-25	<a href="#">Samples</a>
LM385LPE3-2-5	ACTIVE	TO-92	LP	3	1000	Pb-Free (RoHS)	CU SN	N / A for Pkg Type	0 to 70	385-25	<a href="#">Samples</a>
LM385LPR-2-5	ACTIVE	TO-92	LP	3	2000	Pb-Free (RoHS)	CU SN	N / A for Pkg Type	0 to 70	385-25	<a href="#">Samples</a>
LM385PWR-2-5	ACTIVE	TSSOP	PW	8	2000	Green (RoHS & no Sb/Br)	CU NIPDAU	Level-1-260C-UNLIM	0 to 70	385-25	<a href="#">Samples</a>

(1) The marketing status values are defined as follows:

**ACTIVE:** Product device recommended for new designs.

**LIFEBUY:** TI has announced that the device will be discontinued, and a lifetime-buy period is in effect.

**NRND:** Not recommended for new designs. Device is in production to support existing customers, but TI does not recommend using this part in a new design.

**PREVIEW:** Device has been announced but is not in production. Samples may or may not be available.

**OBSELETE:** TI has discontinued the production of the device.

(2) **RoHS:** TI defines "RoHS" to mean semiconductor products that are compliant with the current EU RoHS requirements for all 10 RoHS substances, including the requirement that RoHS substance do not exceed 0.1% by weight in homogeneous materials. Where designed to be soldered at high temperatures, "RoHS" products are suitable for use in specified lead-free processes. TI may reference these types of products as "Pb-Free".

**RoHS Exempt:** TI defines "RoHS Exempt" to mean products that contain lead but are compliant with EU RoHS pursuant to a specific EU RoHS exemption.

**Green:** TI defines "Green" to mean the content of Chlorine (Cl) and Bromine (Br) based flame retardants meet JS709B low halogen requirements of <=1000ppm threshold. Antimony trioxide based flame retardants must also meet the <=1000ppm threshold requirement.

(3) MSL, Peak Temp. - The Moisture Sensitivity Level rating according to the JEDEC industry standard classifications, and peak solder temperature.

(4) There may be additional marking, which relates to the logo, the lot trace code information, or the environmental category on the device.

(5) Multiple Device Markings will be inside parentheses. Only one Device Marking contained in parentheses and separated by a "~" will appear on a device. If a line is indented then it is a continuation of the previous line and the two combined represent the entire Device Marking for that device.

(6) Lead/Ball Finish - Orderable Devices may have multiple material finish options. Finish options are separated by a vertical ruled line. Lead/Ball Finish values may wrap to two lines if the finish value exceeds the maximum column width.

**Important Information and Disclaimer:** The information provided on this page represents TI's knowledge and belief as of the date that it is provided. TI bases its knowledge and belief on information provided by third parties, and makes no representation or warranty as to the accuracy of such information. Efforts are underway to better integrate information from third parties. TI has taken and

continues to take reasonable steps to provide representative and accurate information but may not have conducted destructive testing or chemical analysis on incoming materials and chemicals. TI and TI suppliers consider certain information to be proprietary, and thus CAS numbers and other limited information may not be available for release.

In no event shall TI's liability arising out of such information exceed the total purchase price of the TI part(s) at issue in this document sold by TI to Customer on an annual basis.

## TAPE AND REEL INFORMATION



### QUADRANT ASSIGNMENTS FOR PIN 1 ORIENTATION IN TAPE



\*All dimensions are nominal

Device	Package Type	Package Drawing	Pins	SPQ	Reel Diameter (mm)	Reel Width W1 (mm)	A0 (mm)	B0 (mm)	K0 (mm)	P1 (mm)	W (mm)	Pin1 Quadrant
LM285DR-2-5	SOIC	D	8	2500	330.0	12.4	6.4	5.2	2.1	8.0	12.0	Q1
LM385BDR-2-5	SOIC	D	8	2500	330.0	12.4	6.4	5.2	2.1	8.0	12.0	Q1
LM385BPWR-2-5	TSSOP	PW	8	2000	330.0	12.4	7.0	3.6	1.6	8.0	12.0	Q1
LM385DR-2-5	SOIC	D	8	2500	330.0	12.4	6.4	5.2	2.1	8.0	12.0	Q1
LM385PWR-2-5	TSSOP	PW	8	2000	330.0	12.4	7.0	3.6	1.6	8.0	12.0	Q1

## TAPE AND REEL BOX DIMENSIONS



\*All dimensions are nominal

Device	Package Type	Package Drawing	Pins	SPQ	Length (mm)	Width (mm)	Height (mm)
LM285DR-2-5	SOIC	D	8	2500	340.5	338.1	20.6
LM385BDR-2-5	SOIC	D	8	2500	340.5	338.1	20.6
LM385BPWR-2-5	TSSOP	PW	8	2000	367.0	367.0	35.0
LM385DR-2-5	SOIC	D	8	2500	340.5	338.1	20.6
LM385PWR-2-5	TSSOP	PW	8	2000	367.0	367.0	35.0



D0008A

# PACKAGE OUTLINE

SOIC - 1.75 mm max height

SMALL OUTLINE INTEGRATED CIRCUIT



4214825/C 02/2019

NOTES:

1. Linear dimensions are in inches [millimeters]. Dimensions in parenthesis are for reference only. Controlling dimensions are in inches. Dimensioning and tolerancing per ASME Y14.5M.
2. This drawing is subject to change without notice.
3. This dimension does not include mold flash, protrusions, or gate burrs. Mold flash, protrusions, or gate burrs shall not exceed .006 [0.15] per side.
4. This dimension does not include interlead flash.
5. Reference JEDEC registration MS-012, variation AA.

# EXAMPLE BOARD LAYOUT

D0008A

SOIC - 1.75 mm max height

SMALL OUTLINE INTEGRATED CIRCUIT



LAND PATTERN EXAMPLE  
 EXPOSED METAL SHOWN  
 SCALE:8X



SOLDER MASK DETAILS

4214825/C 02/2019

NOTES: (continued)

- 6. Publication IPC-7351 may have alternate designs.
- 7. Solder mask tolerances between and around signal pads can vary based on board fabrication site.

# EXAMPLE STENCIL DESIGN

D0008A

SOIC - 1.75 mm max height

SMALL OUTLINE INTEGRATED CIRCUIT



SOLDER PASTE EXAMPLE  
BASED ON .005 INCH [0.125 MM] THICK STENCIL  
SCALE:8X

4214825/C 02/2019

NOTES: (continued)

8. Laser cutting apertures with trapezoidal walls and rounded corners may offer better paste release. IPC-7525 may have alternate design recommendations.
9. Board assembly site may have different recommendations for stencil design.

PW0008A



PACKAGE OUTLINE  
TSSOP - 1.2 mm max height

SMALL OUTLINE PACKAGE

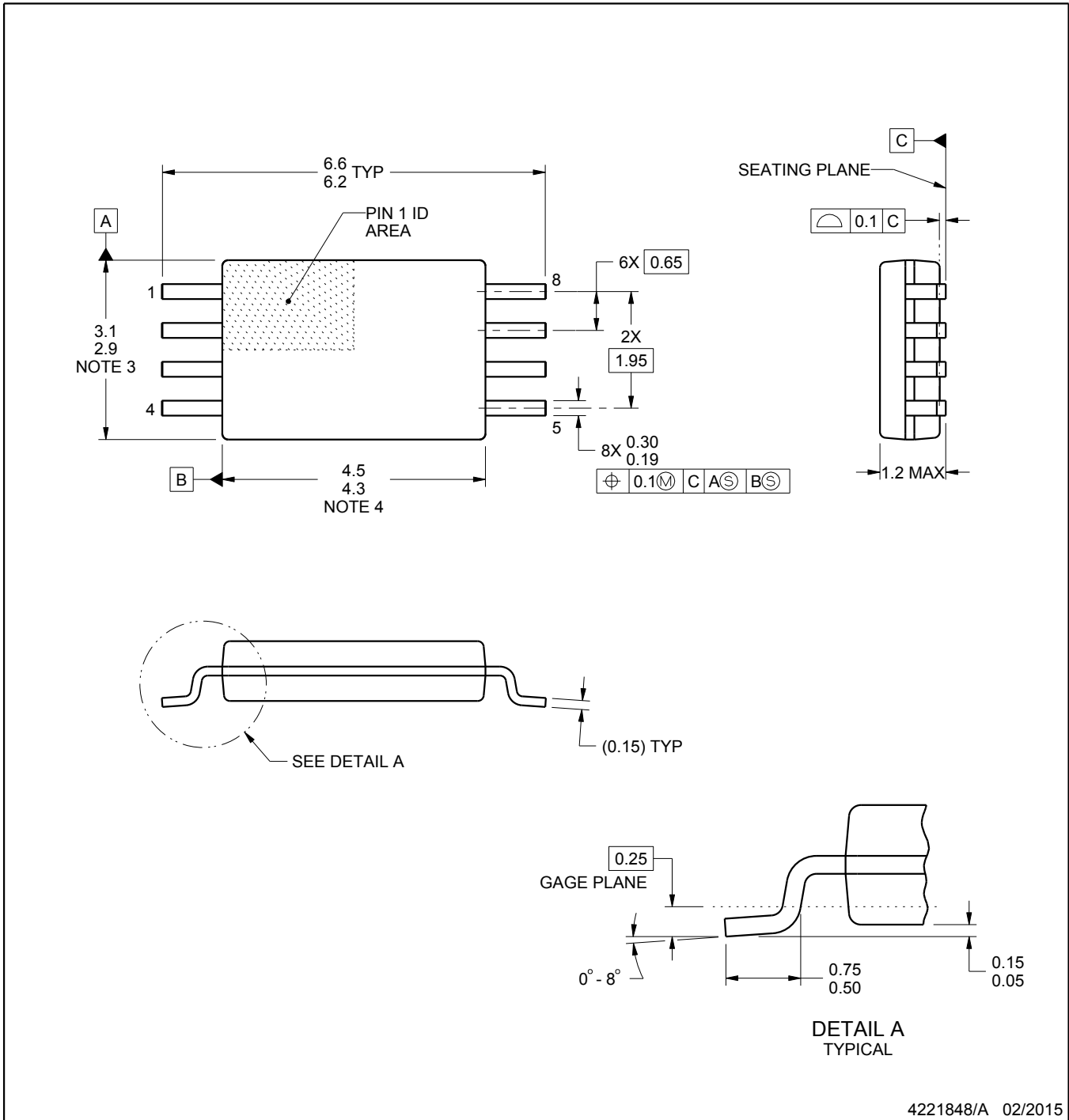

4221848/A 02/2015

NOTES:

- All linear dimensions are in millimeters. Any dimensions in parenthesis are for reference only. Dimensioning and tolerancing per ASME Y14.5M.
- This drawing is subject to change without notice.
- This dimension does not include mold flash, protrusions, or gate burrs. Mold flash, protrusions, or gate burrs shall not exceed 0.15 mm per side.
- This dimension does not include interlead flash. Interlead flash shall not exceed 0.25 mm per side.
- Reference JEDEC registration MO-153, variation AA.

# EXAMPLE BOARD LAYOUT

PW0008A

TSSOP - 1.2 mm max height

SMALL OUTLINE PACKAGE



LAND PATTERN EXAMPLE  
SCALE:10X



SOLDER MASK DETAILS  
NOT TO SCALE

4221848/A 02/2015

NOTES: (continued)

- 6. Publication IPC-7351 may have alternate designs.
- 7. Solder mask tolerances between and around signal pads can vary based on board fabrication site.

# EXAMPLE STENCIL DESIGN

PW0008A

TSSOP - 1.2 mm max height

SMALL OUTLINE PACKAGE



SOLDER PASTE EXAMPLE  
BASED ON 0.125 mm THICK STENCIL  
SCALE:10X

4221848/A 02/2015

NOTES: (continued)

8. Laser cutting apertures with trapezoidal walls and rounded corners may offer better paste release. IPC-7525 may have alternate design recommendations.
9. Board assembly site may have different recommendations for stencil design.

## GENERIC PACKAGE VIEW

LP 3

TO-92 - 5.34 mm max height

TRANSISTOR OUTLINE



Images above are just a representation of the package family, actual package may vary.  
Refer to the product data sheet for package details.

4040001-2/F

LP0003A



# PACKAGE OUTLINE

TO-92 - 5.34 mm max height

TO-92



4215214/B 04/2017

NOTES:

1. All linear dimensions are in millimeters. Any dimensions in parenthesis are for reference only. Dimensioning and tolerancing per ASME Y14.5M.
2. This drawing is subject to change without notice.
3. Lead dimensions are not controlled within this area.
4. Reference JEDEC TO-226, variation AA.
5. Shipping method:
  - a. Straight lead option available in bulk pack only.
  - b. Formed lead option available in tape and reel or ammo pack.
  - c. Specific products can be offered in limited combinations of shipping medium and lead options.
  - d. Consult product folder for more information on available options.



# TAPE SPECIFICATIONS

LP0003A

TO-92 - 5.34 mm max height

TO-92



FOR FORMED LEAD OPTION PACKAGE

4215214/B 04/2017

## IMPORTANT NOTICE AND DISCLAIMER

TI PROVIDES TECHNICAL AND RELIABILITY DATA (INCLUDING DATASHEETS), DESIGN RESOURCES (INCLUDING REFERENCE DESIGNS), APPLICATION OR OTHER DESIGN ADVICE, WEB TOOLS, SAFETY INFORMATION, AND OTHER RESOURCES "AS IS" AND WITH ALL FAULTS, AND DISCLAIMS ALL WARRANTIES, EXPRESS AND IMPLIED, INCLUDING WITHOUT LIMITATION ANY IMPLIED WARRANTIES OF MERCHANTABILITY, FITNESS FOR A PARTICULAR PURPOSE OR NON-INFRINGEMENT OF THIRD PARTY INTELLECTUAL PROPERTY RIGHTS.

These resources are intended for skilled developers designing with TI products. You are solely responsible for (1) selecting the appropriate TI products for your application, (2) designing, validating and testing your application, and (3) ensuring your application meets applicable standards, and any other safety, security, or other requirements. These resources are subject to change without notice. TI grants you permission to use these resources only for development of an application that uses the TI products described in the resource. Other reproduction and display of these resources is prohibited. No license is granted to any other TI intellectual property right or to any third party intellectual property right. TI disclaims responsibility for, and you will fully indemnify TI and its representatives against, any claims, damages, costs, losses, and liabilities arising out of your use of these resources.

TI's products are provided subject to TI's Terms of Sale ([www.ti.com/legal/termsofsale.html](http://www.ti.com/legal/termsofsale.html)) or other applicable terms available either on [ti.com](http://ti.com) or provided in conjunction with such TI products. TI's provision of these resources does not expand or otherwise alter TI's applicable warranties or warranty disclaimers for TI products.

Mailing Address: Texas Instruments, Post Office Box 655303, Dallas, Texas 75265  
Copyright © 2019, Texas Instruments Incorporated

## Looking for pricing, stock, or lifecycle information?

Click below to explore more details on WIN SOURCE:

 [View LM285LPR-2-5 on WIN SOURCE](#)

 [Texas Instruments](#) Information

## Optimize Your Supply Chain with WIN SOURCE Solutions

-  Global Sourcing Solution
-  Obsolete Management
-  Cost Control Management
-  Shortage Management
-  Alternative Solution
-  Excess Inventory Management