



**THE DATASHEET OF
PMDPB42UN,115**



Important notice

Dear Customer,

On 7 February 2017 the former NXP Standard Product business became a new company with the tradename **Nexperia**. Nexperia is an industry leading supplier of Discrete, Logic and PowerMOS semiconductors with its focus on the automotive, industrial, computing, consumer and wearable application markets

In data sheets and application notes which still contain NXP or Philips Semiconductors references, use the references to Nexperia, as shown below.

Instead of <http://www.nxp.com>, <http://www.philips.com/> or <http://www.semiconductors.philips.com/>, use <http://www.nexperia.com>

Instead of sales.addresses@www.nxp.com or sales.addresses@www.semiconductors.philips.com, use salesaddresses@nexperia.com (email)

Replace the copyright notice at the bottom of each page or elsewhere in the document, depending on the version, as shown below:

- © NXP N.V. (year). All rights reserved or © Koninklijke Philips Electronics N.V. (year). All rights reserved

Should be replaced with:

- © **Nexperia B.V. (year). All rights reserved.**

If you have any questions related to the data sheet, please contact our nearest sales office via e-mail or telephone (details via salesaddresses@nexperia.com). Thank you for your cooperation and understanding,

Kind regards,

Team Nexperia



PMDPB42UN

20 V, dual N-channel Trench MOSFET

Rev. 1 — 16 May 2012

Product data sheet

1. Product profile

1.1 General description

Dual N-channel enhancement mode Field-Effect Transistor (FET) in a small and leadless ultra thin DFN2020-6 (SOT1118) Surface-Mounted Device (SMD) plastic package using Trench MOSFET technology.

1.2 Features and benefits

- Very fast switching
- Trench MOSFET technology
- Small and leadless ultra thin SMD plastic package: 2 x 2 x 0.65 mm
- Exposed drain pad for excellent thermal conduction

1.3 Applications

- Charging switch for portable devices
- DC-to-DC converters
- Small brushless DC motor drive
- Power management in battery-driven portables
- Hard disc and computing power management

1.4 Quick reference data

Table 1. Quick reference data

Symbol	Parameter	Conditions	Min	Typ	Max	Unit
Per transistor						
V_{DS}	drain-source voltage	$T_j = 25\text{ °C}$	-	-	20	V
V_{GS}	gate-source voltage		-8	-	8	V
I_D	drain current	$V_{GS} = 4.5\text{ V}; T_{amb} = 25\text{ °C}; t \leq 5\text{ s}$	[1]	-	5.1	A
Static characteristics (per transistor)						
$R_{DS(on)}$	drain-source on-state resistance	$V_{GS} = 4.5\text{ V}; I_D = 3.9\text{ A}; T_j = 25\text{ °C}$	-	40	50	m Ω

[1] Device mounted on an FR4 Printed-Circuit Board (PCB), single-sided copper, tin-plated, mounting pad for drain 6 cm².



2. Pinning information

Table 2. Pinning information

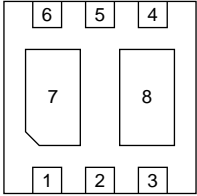
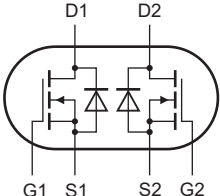
Pin	Symbol	Description	Simplified outline	Graphic symbol
1	S1	source TR1	 <p>Transparent top view</p> <p>SOT1118 (DFN2020-6)</p>	 <p>017aaa254</p>
2	G1	gate TR1		
3	D2	drain TR2		
4	S2	source TR2		
5	G2	gate TR2		
6	D1	drain TR1		
7	D1	drain TR1		
8	D2	drain TR2		

3. Ordering information

Table 3. Ordering information

Type number	Package		Description	Version
	Name			
PMDPB42UN	DFN2020-6		plastic thermal enhanced ultra thin small outline package; no leads; 6 terminals	SOT1118

4. Marking

Table 4. Marking codes

Type number	Marking code
PMDPB42UN	1L

5. Limiting values

Table 5. Limiting values

In accordance with the Absolute Maximum Rating System (IEC 60134).

Symbol	Parameter	Conditions	Min	Max	Unit	
Per transistor						
V _{DS}	drain-source voltage	T _j = 25 °C	-	20	V	
V _{GS}	gate-source voltage		-8	8	V	
I _D	drain current	V _{GS} = 4.5 V; T _{amb} = 25 °C; t ≤ 5 s	[1]	-	5.1	A
		V _{GS} = 4.5 V; T _{amb} = 25 °C	[1]	-	3.9	A
		V _{GS} = 4.5 V; T _{amb} = 100 °C	[1]	-	2.5	A
I _{DM}	peak drain current	T _{amb} = 25 °C; single pulse; t _p ≤ 10 μs	-	15.6	A	
P _{tot}	total power dissipation	T _{amb} = 25 °C	[2]	-	510	mW
			[1]	-	1165	mW
		T _{sp} = 25 °C		-	8330	mW
Source-drain diode						
I _S	source current	T _{amb} = 25 °C	[1]	-	1.2	A
Per device						
T _j	junction temperature		-55	150	°C	
T _{amb}	ambient temperature		-55	150	°C	
T _{stg}	storage temperature		-65	150	°C	

[1] Device mounted on an FR4 Printed-Circuit Board (PCB), single-sided copper, tin-plated, mounting pad for drain 6 cm².

[2] Device mounted on an FR4 Printed-Circuit Board (PCB), single-sided copper, tin-plated and standard footprint.

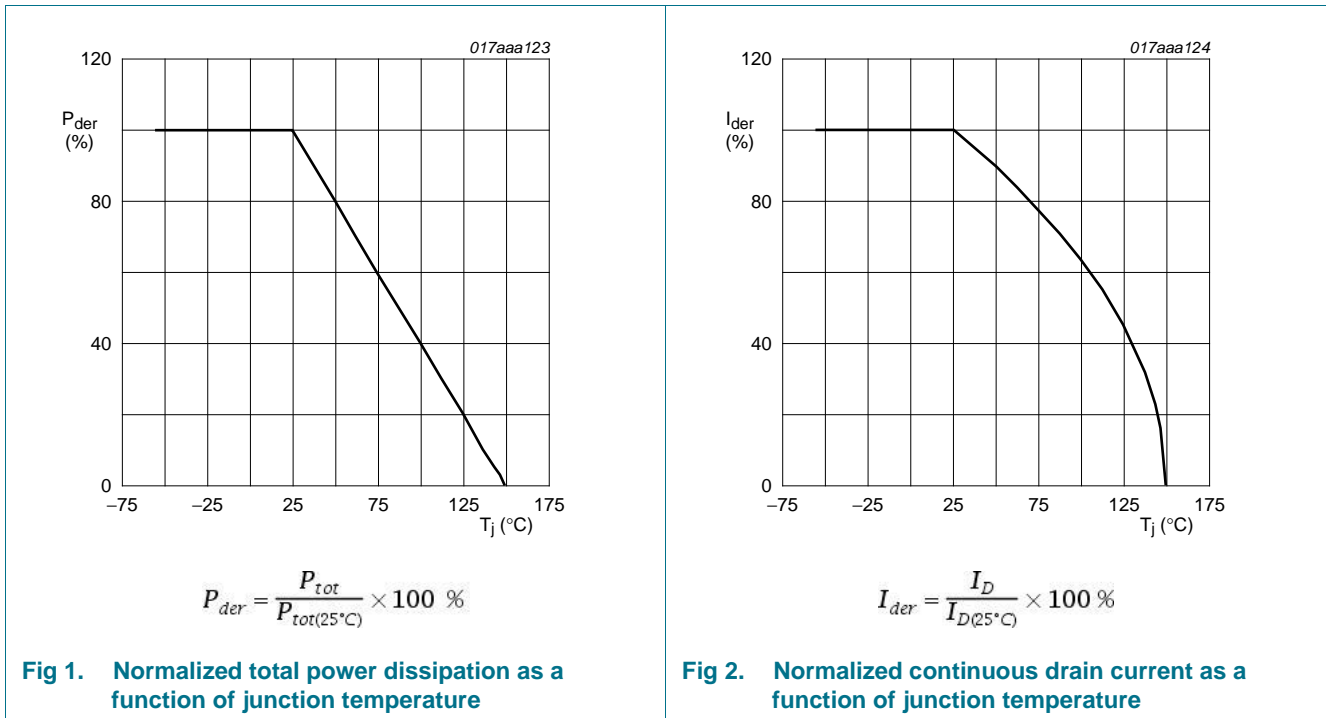

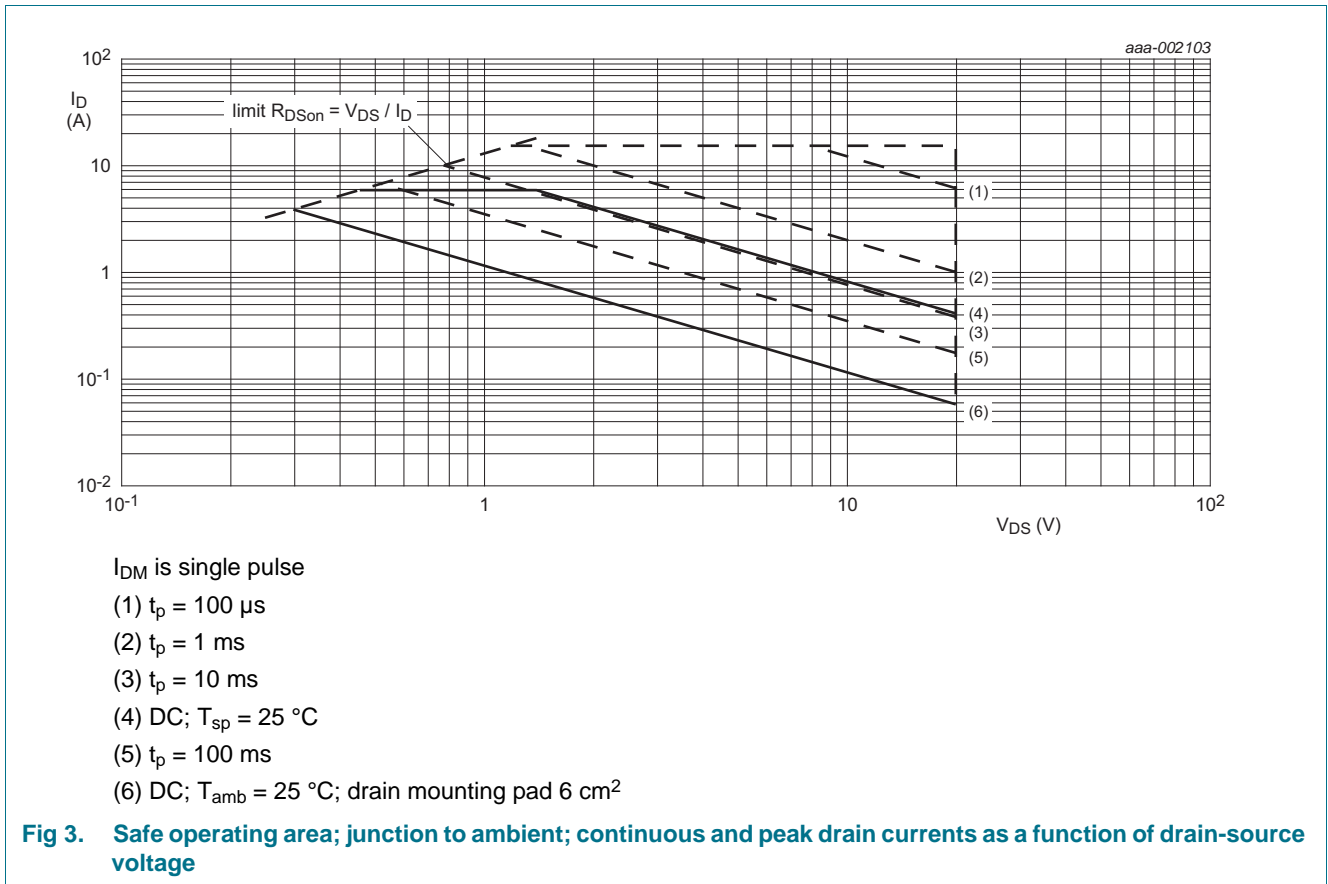

6. Thermal characteristics

Table 6. Thermal characteristics

Symbol	Parameter	Conditions	Min	Typ	Max	Unit	
Per transistor							
$R_{th(j-a)}$	thermal resistance from junction to ambient	in free air	[1]	-	213	245	K/W
			[2]	-	93	107	K/W
		in free air; $t \leq 5 s$	[2]	-	55	64	K/W
$R_{th(j-sp)}$	thermal resistance from junction to solder point		-	12	15	K/W	

[1] Device mounted on an FR4 PCB, single-sided copper, tin-plated and standard footprint.

[2] Device mounted on an FR4 PCB, single-sided copper, tin-plated, mounting pad for drain 6 cm^2 .

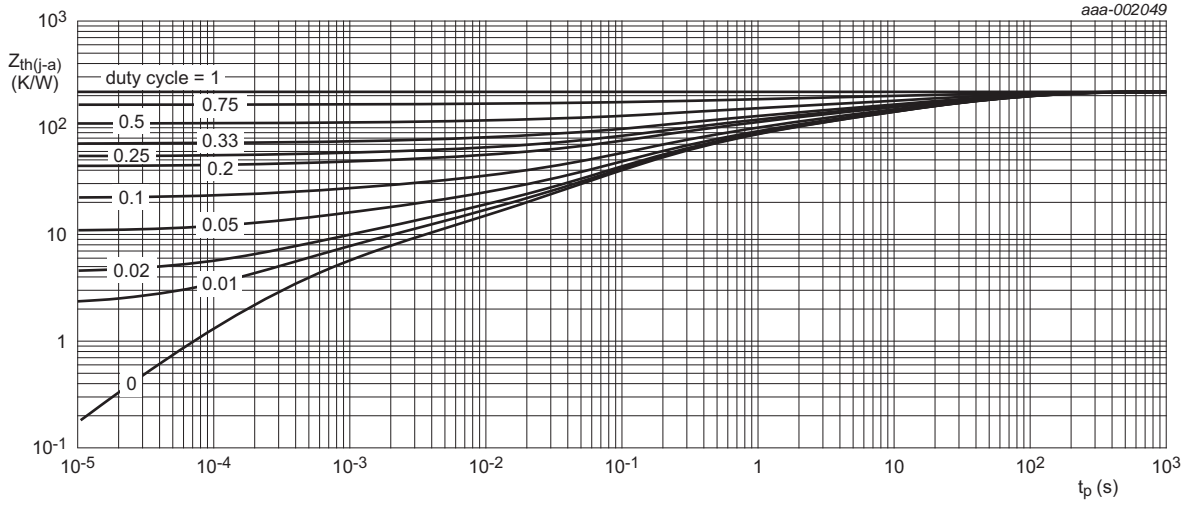

FR4 PCB standard footprint

Fig 4. Transient thermal impedance from junction to ambient as a function of pulse duration; typical values

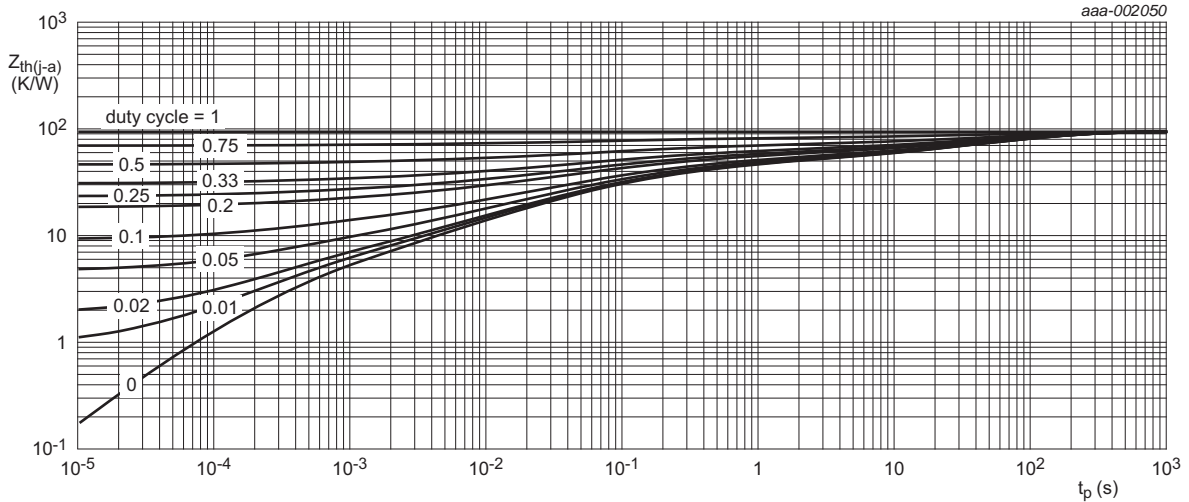

FR4 PCB, mounting pad for drain 6 cm^2

Fig 5. Transient thermal impedance from junction to ambient as a function of pulse duration; typical values

7. Characteristics

Table 7. Characteristics

Symbol	Parameter	Conditions	Min	Typ	Max	Unit
Static characteristics (per transistor)						
$V_{(BR)DSS}$	drain-source breakdown voltage	$I_D = 250 \mu\text{A}; V_{GS} = 0 \text{ V}; T_j = 25 \text{ }^\circ\text{C}$	20	-	-	V
V_{GSth}	gate-source threshold voltage	$I_D = 250 \mu\text{A}; V_{DS} = V_{GS}; T_j = 25 \text{ }^\circ\text{C}$	0.4	0.7	1	V
I_{DSS}	drain leakage current	$V_{DS} = 20 \text{ V}; V_{GS} = 0 \text{ V}; T_j = 25 \text{ }^\circ\text{C}$	-	-	1	μA
		$V_{DS} = 20 \text{ V}; V_{GS} = 0 \text{ V}; T_j = 150 \text{ }^\circ\text{C}$	-	-	20	μA
I_{GSS}	gate leakage current	$V_{GS} = 8 \text{ V}; V_{DS} = 0 \text{ V}; T_j = 25 \text{ }^\circ\text{C}$	-	-	100	nA
		$V_{GS} = -8 \text{ V}; V_{DS} = 0 \text{ V}; T_j = 25 \text{ }^\circ\text{C}$	-	-	100	nA
R_{DSon}	drain-source on-state resistance	$V_{GS} = 4.5 \text{ V}; I_D = 3.9 \text{ A}; T_j = 25 \text{ }^\circ\text{C}$	-	40	50	m Ω
		$V_{GS} = 4.5 \text{ V}; I_D = 3.9 \text{ A}; T_j = 150 \text{ }^\circ\text{C}$	-	61	76	m Ω
		$V_{GS} = 2.5 \text{ V}; I_D = 3.2 \text{ A}; T_j = 25 \text{ }^\circ\text{C}$	-	53	70	m Ω
		$V_{GS} = 1.8 \text{ V}; I_D = 0.8 \text{ A}; T_j = 25 \text{ }^\circ\text{C}$	-	82	123	m Ω
g_{fs}	forward transconductance	$V_{DS} = 10 \text{ V}; I_D = 3.9 \text{ A}; T_j = 25 \text{ }^\circ\text{C}$	-	11	-	S
Dynamic characteristics (per transistor)						
$Q_{G(tot)}$	total gate charge	$V_{DS} = 10 \text{ V}; I_D = 3.9 \text{ A}; V_{GS} = 4.5 \text{ V}; T_j = 25 \text{ }^\circ\text{C}$	-	2	3.5	nC
Q_{GS}	gate-source charge		-	0.4	-	nC
Q_{GD}	gate-drain charge		-	0.6	-	nC
C_{iss}	input capacitance	$V_{DS} = 10 \text{ V}; f = 1 \text{ MHz}; V_{GS} = 0 \text{ V}; T_j = 25 \text{ }^\circ\text{C}$	-	185	-	pF
C_{oss}	output capacitance		-	55	-	pF
C_{rss}	reverse transfer capacitance		-	25	-	pF
$t_{d(on)}$	turn-on delay time	$V_{DS} = 10 \text{ V}; I_D = 3.9 \text{ A}; V_{GS} = 4.5 \text{ V}; R_{G(ext)} = 6 \text{ } \Omega; T_j = 25 \text{ }^\circ\text{C}$	-	6	-	ns
t_r	rise time		-	30	-	ns
$t_{d(off)}$	turn-off delay time		-	20	-	ns
t_f	fall time		-	15	-	ns
Source-drain diode (per transistor)						
V_{SD}	source-drain voltage	$I_S = 1.2 \text{ A}; V_{GS} = 0 \text{ V}; T_j = 25 \text{ }^\circ\text{C}$	-	0.8	1.2	V

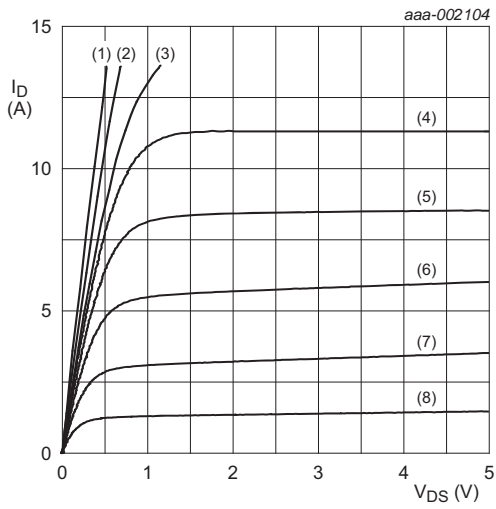

$T_j = 25\text{ }^\circ\text{C}$

- (1) $V_{GS} = 4.5\text{ V}$
- (2) $V_{GS} = 3.0\text{ V}$
- (3) $V_{GS} = 2.4\text{ V}$
- (4) $V_{GS} = 2.2\text{ V}$
- (5) $V_{GS} = 2.0\text{ V}$
- (6) $V_{GS} = 1.8\text{ V}$
- (7) $V_{GS} = 1.6\text{ V}$
- (8) $V_{GS} = 1.4\text{ V}$

Fig 6. Output characteristics: drain current as a function of drain-source voltage; typical values

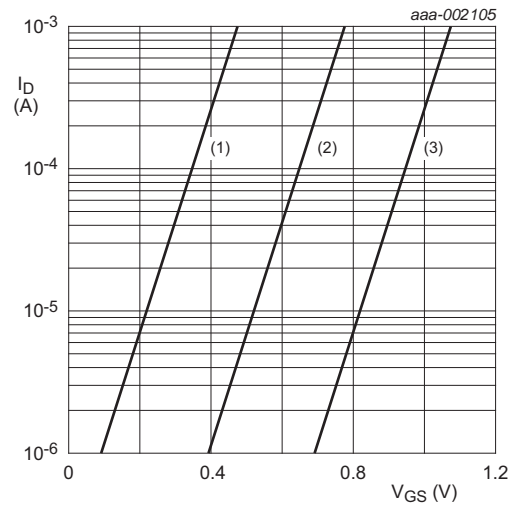

$T_j = 25\text{ }^\circ\text{C}; V_{DS} = 15\text{ V}$

- (1) minimum values
- (2) typical values
- (3) maximum values

Fig 7. Subthreshold drain current as a function of gate-source voltage

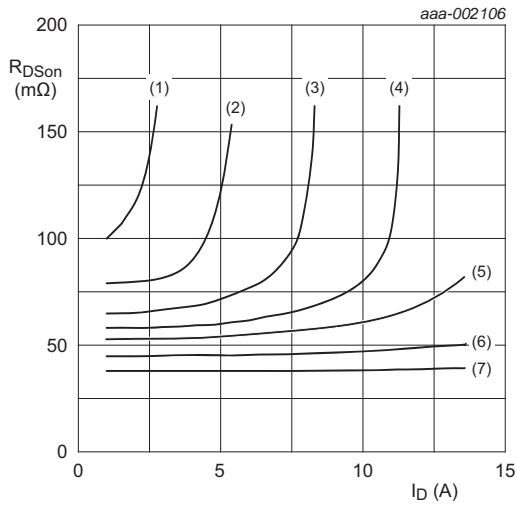

$T_j = 25\text{ }^\circ\text{C}$

- (1) $V_{GS} = 1.6\text{ V}$
- (2) $V_{GS} = 1.8\text{ V}$
- (3) $V_{GS} = 2.0\text{ V}$
- (4) $V_{GS} = 2.2\text{ V}$
- (5) $V_{GS} = 2.4\text{ V}$
- (6) $V_{GS} = 3.0\text{ V}$
- (7) $V_{GS} = 4.5\text{ V}$

Fig 8. Drain-source on-state resistance as a function of drain current; typical values

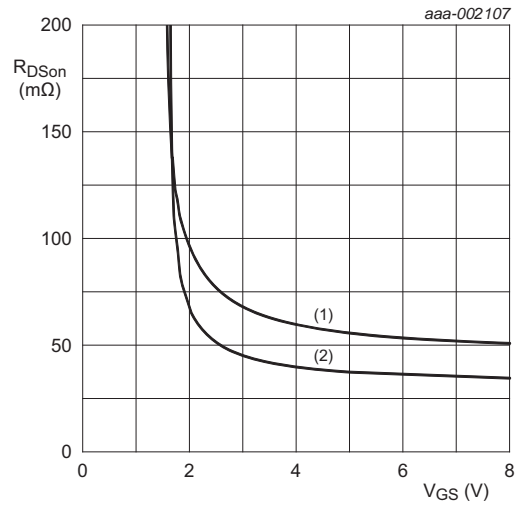

$I_D = 3.4\text{ A}$

- (1) $T_j = 150\text{ }^\circ\text{C}$
- (2) $T_j = 25\text{ }^\circ\text{C}$

Fig 9. Drain-source on-state resistance as a function of gate-source voltage; typical values

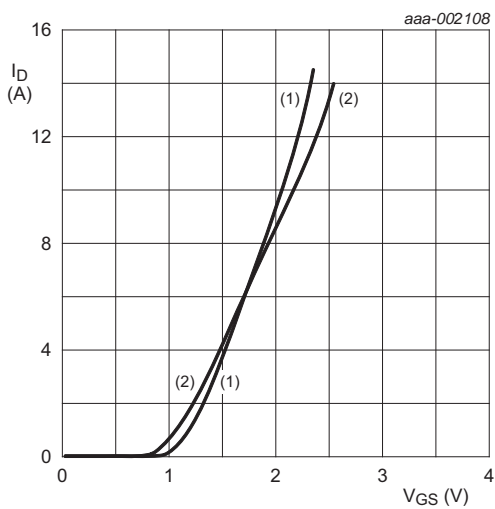

$V_{DS} > I_D \times R_{DSon}$

- (1) $T_j = 25\text{ }^\circ\text{C}$
- (2) $T_j = 150\text{ }^\circ\text{C}$

Fig 10. Transfer characteristics: drain current as a function of gate-source voltage; typical values

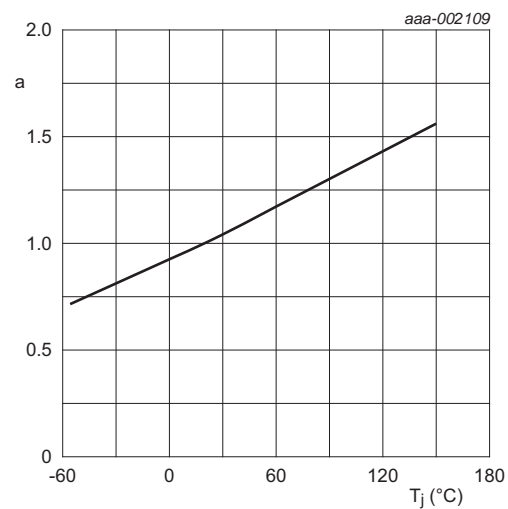

$$a = \frac{R_{DSon}}{R_{DSon(25^\circ\text{C})}}$$

Fig 11. Normalized drain-source on-state resistance as a function of junction temperature; typical values

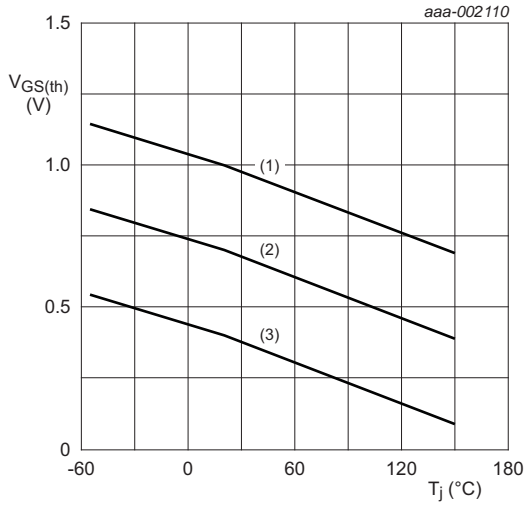

$I_D = 0.25$ mA; $V_{DS} = V_{GS}$

- (1) maximum values
- (2) typical values
- (3) minimum values

Fig 12. Gate-source threshold voltage as a function of junction temperature

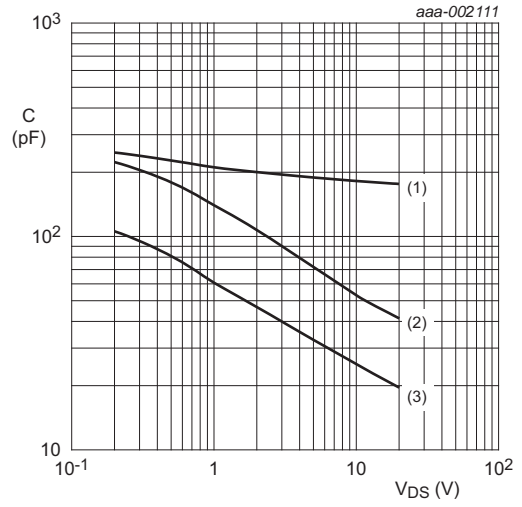

$f = 1$ MHz; $V_{GS} = 0$ V

- (1) C_{iss}
- (2) C_{oss}
- (3) C_{rss}

Fig 13. Input, output and reverse transfer capacitances as a function of drain-source voltage; typical values

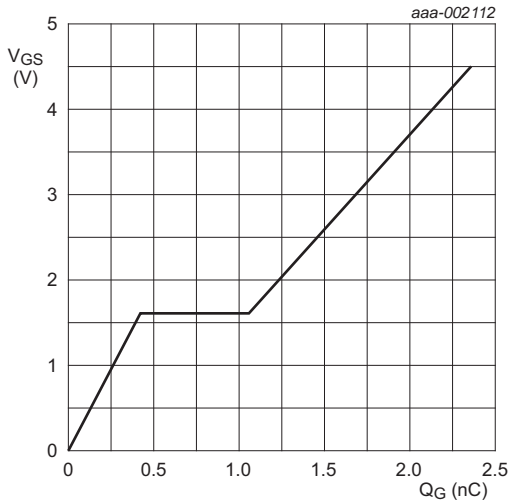

$I_D = 3.9$ A; $V_{DS} = 15$ V; $T_{amb} = 25$ °C

Fig 14. Gate-source voltage as a function of gate charge; typical values

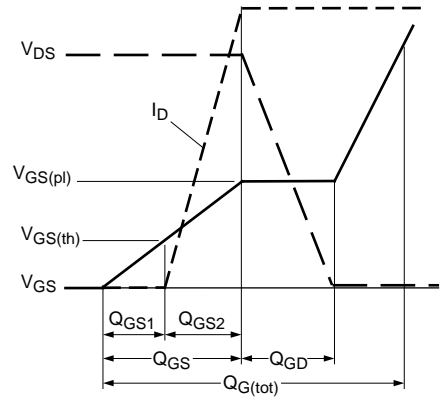

003aaa508

Fig 15. Gate charge waveform definitions

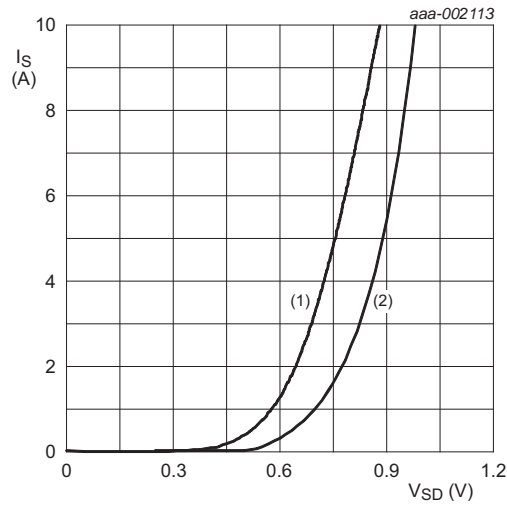

$V_{GS} = 0\text{ V}$
 (1) $T_j = 150\text{ °C}$
 (2) $T_j = 25\text{ °C}$

Fig 16. Source current as a function of source-drain voltage; typical values

8. Test information

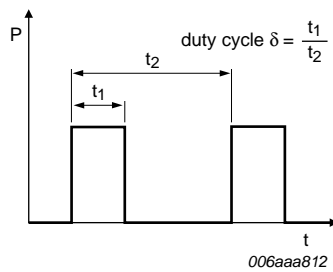

Fig 17. Duty cycle definition

9. Package outline

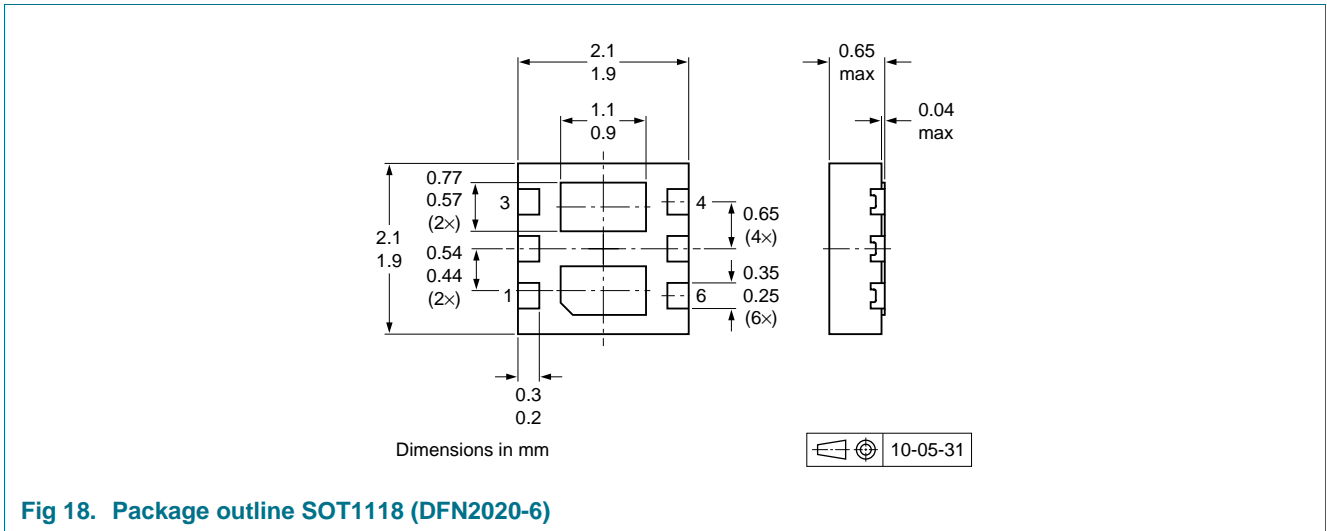

Fig 18. Package outline SOT1118 (DFN2020-6)

10. Soldering

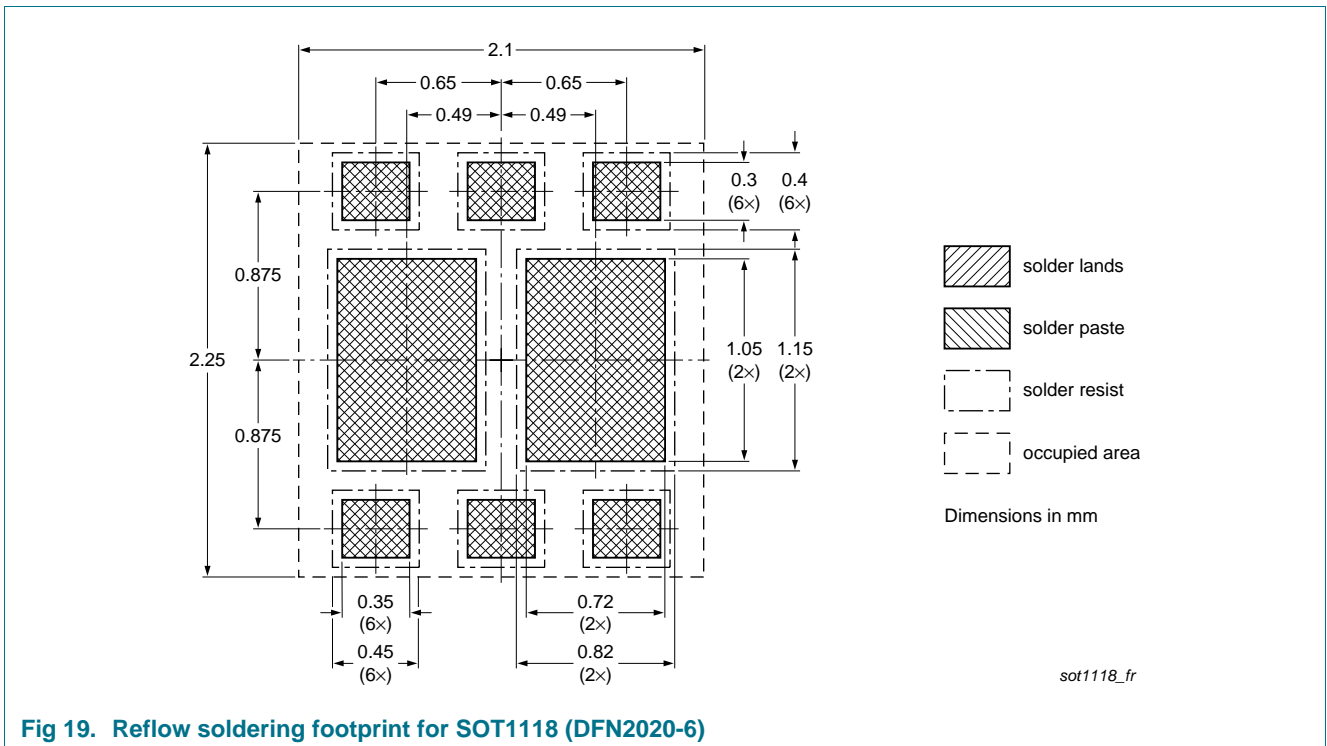

Fig 19. Reflow soldering footprint for SOT1118 (DFN2020-6)

11. Revision history

Table 8. Revision history

Document ID	Release date	Data sheet status	Change notice	Supersedes
PMDPB42UN v.1	20120516	Product data sheet	-	-

12. Legal information

12.1 Data sheet status

Document status ^[1] [2]	Product status ^[3]	Definition
Objective [short] data sheet	Development	This document contains data from the objective specification for product development.
Preliminary [short] data sheet	Qualification	This document contains data from the preliminary specification.
Product [short] data sheet	Production	This document contains the product specification.

[1] Please consult the most recently issued document before initiating or completing a design.

[2] The term 'short data sheet' is explained in section "Definitions".

[3] The product status of device(s) described in this document may have changed since this document was published and may differ in case of multiple devices. The latest product status information is available on the Internet at URL <http://www.nxp.com>.

12.2 Definitions

Preview — The document is a preview version only. The document is still subject to formal approval, which may result in modifications or additions. NXP Semiconductors does not give any representations or warranties as to the accuracy or completeness of information included herein and shall have no liability for the consequences of use of such information.

Draft — The document is a draft version only. The content is still under internal review and subject to formal approval, which may result in modifications or additions. NXP Semiconductors does not give any representations or warranties as to the accuracy or completeness of information included herein and shall have no liability for the consequences of use of such information.

Short data sheet — A short data sheet is an extract from a full data sheet with the same product type number(s) and title. A short data sheet is intended for quick reference only and should not be relied upon to contain detailed and full information. For detailed and full information see the relevant full data sheet, which is available on request via the local NXP Semiconductors sales office. In case of any inconsistency or conflict with the short data sheet, the full data sheet shall prevail.

Product specification — The information and data provided in a Product data sheet shall define the specification of the product as agreed between NXP Semiconductors and its customer, unless NXP Semiconductors and customer have explicitly agreed otherwise in writing. In no event however, shall an agreement be valid in which the NXP Semiconductors product is deemed to offer functions and qualities beyond those described in the Product data sheet.

12.3 Disclaimers

Limited warranty and liability — Information in this document is believed to be accurate and reliable. However, NXP Semiconductors does not give any representations or warranties, expressed or implied, as to the accuracy or completeness of such information and shall have no liability for the consequences of use of such information. NXP Semiconductors takes no responsibility for the content in this document if provided by an information source outside of NXP Semiconductors.

In no event shall NXP Semiconductors be liable for any indirect, incidental, punitive, special or consequential damages (including - without limitation - lost profits, lost savings, business interruption, costs related to the removal or replacement of any products or rework charges) whether or not such damages are based on tort (including negligence), warranty, breach of contract or any other legal theory.

Notwithstanding any damages that customer might incur for any reason whatsoever, NXP Semiconductors' aggregate and cumulative liability towards customer for the products described herein shall be limited in accordance with the *Terms and conditions of commercial sale* of NXP Semiconductors.

Right to make changes — NXP Semiconductors reserves the right to make changes to information published in this document, including without limitation specifications and product descriptions, at any time and without notice. This document supersedes and replaces all information supplied prior to the publication hereof.

Suitability for use — NXP Semiconductors products are not designed, authorized or warranted to be suitable for use in life support, life-critical or safety-critical systems or equipment, nor in applications where failure or malfunction of an NXP Semiconductors product can reasonably be expected to result in personal injury, death or severe property or environmental damage. NXP Semiconductors and its suppliers accept no liability for inclusion and/or use of NXP Semiconductors products in such equipment or applications and therefore such inclusion and/or use is at the customer's own risk.

Quick reference data — The Quick reference data is an extract of the product data given in the Limiting values and Characteristics sections of this document, and as such is not complete, exhaustive or legally binding.

Applications — Applications that are described herein for any of these products are for illustrative purposes only. NXP Semiconductors makes no representation or warranty that such applications will be suitable for the specified use without further testing or modification.

Customers are responsible for the design and operation of their applications and products using NXP Semiconductors products, and NXP Semiconductors accepts no liability for any assistance with applications or customer product design. It is customer's sole responsibility to determine whether the NXP Semiconductors product is suitable and fit for the customer's applications and products planned, as well as for the planned application and use of customer's third party customer(s). Customers should provide appropriate design and operating safeguards to minimize the risks associated with their applications and products.

NXP Semiconductors does not accept any liability related to any default, damage, costs or problem which is based on any weakness or default in the customer's applications or products, or the application or use by customer's third party customer(s). Customer is responsible for doing all necessary testing for the customer's applications and products using NXP Semiconductors products in order to avoid a default of the applications and the products or of the application or use by customer's third party customer(s). NXP does not accept any liability in this respect.

Limiting values — Stress above one or more limiting values (as defined in the Absolute Maximum Ratings System of IEC 60134) will cause permanent damage to the device. Limiting values are stress ratings only and (proper) operation of the device at these or any other conditions above those given in the Recommended operating conditions section (if present) or the Characteristics sections of this document is not warranted. Constant or repeated exposure to limiting values will permanently and irreversibly affect the quality and reliability of the device.

Terms and conditions of commercial sale — NXP Semiconductors products are sold subject to the general terms and conditions of commercial sale, as published at <http://www.nxp.com/profile/terms>, unless otherwise agreed in a valid written individual agreement. In case an individual agreement is concluded only the terms and conditions of the respective agreement shall apply. NXP Semiconductors hereby expressly objects to applying the customer's general terms and conditions with regard to the purchase of NXP Semiconductors products by customer.

No offer to sell or license — Nothing in this document may be interpreted or construed as an offer to sell products that is open for acceptance or the grant, conveyance or implication of any license under any copyrights, patents or other industrial or intellectual property rights.

Export control — This document as well as the item(s) described herein may be subject to export control regulations. Export might require a prior authorization from competent authorities.

Non-automotive qualified products — Unless this data sheet expressly states that this specific NXP Semiconductors product is automotive qualified, the product is not suitable for automotive use. It is neither qualified nor tested in accordance with automotive testing or application requirements. NXP Semiconductors accepts no liability for inclusion and/or use of non-automotive qualified products in automotive equipment or applications.

In the event that customer uses the product for design-in and use in automotive applications to automotive specifications and standards, customer (a) shall use the product without NXP Semiconductors' warranty of the

product for such automotive applications, use and specifications, and (b) whenever customer uses the product for automotive applications beyond NXP Semiconductors' specifications such use shall be solely at customer's own risk, and (c) customer fully indemnifies NXP Semiconductors for any liability, damages or failed product claims resulting from customer design and use of the product for automotive applications beyond NXP Semiconductors' standard warranty and NXP Semiconductors' product specifications.

Translations — A non-English (translated) version of a document is for reference only. The English version shall prevail in case of any discrepancy between the translated and English versions.

12.4 Trademarks

Notice: All referenced brands, product names, service names and trademarks are the property of their respective owners.

Adelante, Bitport, Bitsound, CoolFlux, CoReUse, DESFire, EZ-HV, FabKey, GreenChip, HiPerSmart, HITAG, I²C-bus logo, ICODE, I-CODE, ITEC, Labelution, MIFARE, MIFARE Plus, MIFARE Ultralight, MoReUse, QLPK, Silicon Tuner, SiliconMAX, SmartXA, STARplug, TOPFET, TrenchMOS, TriMedia and UCODE — are trademarks of NXP B.V.

HD Radio and **HD Radio** logo — are trademarks of iBiquity Digital Corporation.

13. Contact information

For more information, please visit: <http://www.nxp.com>

For sales office addresses, please send an email to: salesaddresses@nxp.com

14. Contents

1	Product profile	1
1.1	General description	1
1.2	Features and benefits	1
1.3	Applications	1
1.4	Quick reference data	1
2	Pinning information	2
3	Ordering information	2
4	Marking	2
5	Limiting values	3
6	Thermal characteristics	4
7	Characteristics	6
8	Test information	10
9	Package outline	11
10	Soldering	11
11	Revision history	12
12	Legal information	13
12.1	Data sheet status	13
12.2	Definitions	13
12.3	Disclaimers	13
12.4	Trademarks	14
13	Contact information	14

Please be aware that important notices concerning this document and the product(s) described herein, have been included in section 'Legal information'.

© NXP B.V. 2012.

All rights reserved.

For more information, please visit: <http://www.nxp.com>

For sales office addresses, please send an email to: salesaddresses@nxp.com

Date of release: 16 May 2012

Document identifier: PMDPB42UN

Looking for pricing, stock, or lifecycle information?

Click below to explore more details on WIN SOURCE:

- ⊖ [View PMDPB42UN,115](#) on WIN SOURCE
- ⊖ [NXP / Nexperia](#) Information

Optimize Your Supply Chain with WIN SOURCE Solutions

- ✓ Global Sourcing Solution
- ✓ Obsolete Management
- ✓ Cost Control Management
- ✓ Shortage Management
- ✓ Alternative Solution
- ✓ Excess Inventory Management