



**THE DATASHEET OF
HMA121CR1**



HMA121 Series

HMA124

HMA2701 Series

HMAA2705

DESCRIPTION

The HMA124, HMA121 series and HMA2701 series consists of a gallium arsenide infrared emitting diode driving a silicon phototransistor in a compact 4-pin mini-flat package. The lead pitch is 2.54 mm.

The HMAA2705 consists of two gallium arsenide infrared emitting diodes, connected in inverse parallel, driving a single silicon phototransistor in a compact 4-pin mini-flat package. The lead pitch is 2.54mm.

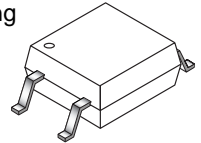

FEATURES

- Compact 4-pin package (2.4 mm maximum standoff height)
- Current Transfer Ratio in selected groups

HMA121: 50–600%	HMA2701: 50–300%
HMA121A: 100–300%	HMA2701A: 150–300%
HMA121B: 50–150%	HMA2701B: 80–160%
HMA121C: 100–200%	HMA124: 100% MIN
HMA121D: 50–100%	HMAA2705: 50–300%
HMA121E: 150–300%	
HMA121F: 100–600%	
- Available in tape and reel quantities of 500 and 2500.
- Applicable to Infrared Ray reflow (230°C max, 30 seconds.)
- BSI (File #8611/8612), CSA (File #1162301), UL (File #E90700) and VDE (File #136480) certified
- Creepage ≥ 5 mm, typical 5.2 mm
- Clearance ≥ 5 mm, typical 5.2 mm

APPLICATIONS

HMAA2705

- AC line monitor
- Unknown polarity DC sensor
- Telephone line receiver

HMA121 series, HMA2701 series, HMA124

- Digital logic inputs
- Microprocessor inputs
- Power supply monitor
- Twisted pair line receiver
- Telephone line receiver

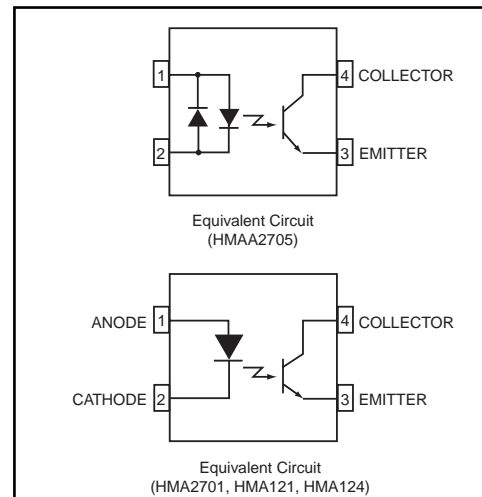
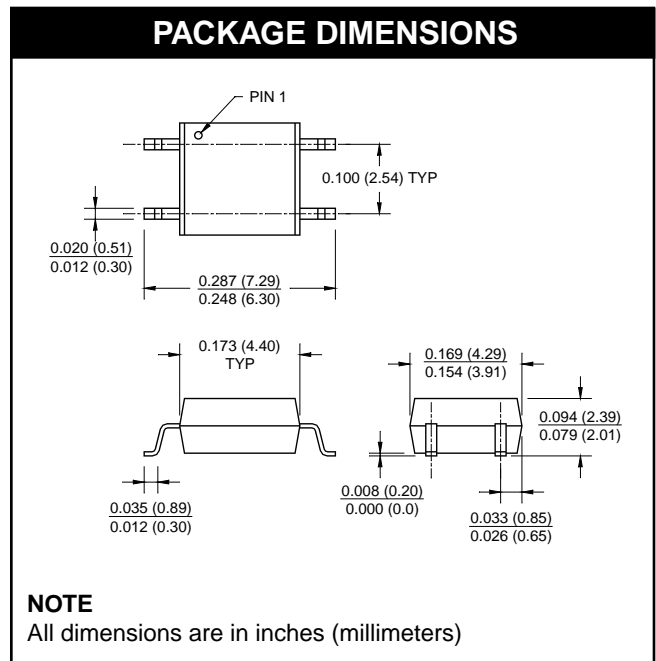

HMA121 Series

HMA124

HMA2701 Series

HMAA2705

ABSOLUTE MAXIMUM RATINGS ($T_A = 25^\circ\text{C}$ unless otherwise specified)			
Parameter	Symbol	Value	Units
TOTAL PACKAGE			
Storage Temperature	T_{STG}	-40 to +125	$^\circ\text{C}$
Operating Temperature	T_{OPR}	-40 to +100	$^\circ\text{C}$
EMITTER			
Continuous Forward Current	$I_{\text{F (avg)}}$	50	mA
Peak Forward Current (1 μs pulse, 300 pps.)	$I_{\text{F (pk)}}$	1	A
Reverse Input Voltage (HMA)	V_{R}	6	V
Power Dissipation	P_{D}	70	mW
Derate linearly (above 25°C)		0.65	mW/ $^\circ\text{C}$
DETECTOR			
Continuous Collector Current		80	mA
Power Dissipation	P_{D}	150	mW
Derate linearly (above 25°C)		2.0	mW/ $^\circ\text{C}$
Collector-Emitter Voltage	V_{CEO}	HMA2701 Series, HMAA2705 40	V
		HMA121 Series, HMA124 80	
Emitter-Collector Voltage	V_{ECO}	7	V

HMA121 Series

HMA124

HMA2701 Series

HMAA2705

ELECTRICAL CHARACTERISTICS ($T_A = 25^\circ\text{C}$)

INDIVIDUAL COMPONENT CHARACTERISTICS

Parameter	Test Conditions	Symbol	Device	Min	Typ**	Max	Unit
EMITTER Forward Voltage	$(I_F = 10 \text{ mA})$	V_F	HMA121 Series	1.0		1.3	V
			HMA124				
	$(I_F = 5 \text{ mA})$		HMA2701 Series			1.4	
			HMAA2705				
Reverse Current	$(V_R = 5 \text{ V})$	I_R	HMA2701 Series			5	μA
			HMA121 Series				
			HMA124				
DETECTOR Breakdown Voltage Collector to Emitter	$(I_C = 1 \text{ mA}, I_F = 0)$	BV_{CEO}	HMA121 Series	80			V
			HMA124				
			HMA2701 Series	40			
			HMAA2705				
Emitter to Collector	$(I_E = 100 \mu\text{A}, I_F = 0)$	BV_{ECO}	All	7			
Collector Dark Current	$(V_{CE} = 40 \text{ V}, I_F = 0)$	I_{CEO}	All			100	nA
Capacitance	$(V_{CE} = 0 \text{ V}, f = 1 \text{ MHz})$	C_{CE}	All		10		pF

HMA121 Series

HMA124

HMA2701 Series

HMAA2705

TRANSFER CHARACTERISTICS ($T_A = 25^\circ\text{C}$)							
Characteristic	Test Conditions	Symbol	Device	Min	Typ**	Max	Unit
DC Current Transfer Ratio	$(I_F = \pm 5 \text{ mA}, V_{CE} = 5 \text{ V})$	CTR	HMAA2705	50		300	%
			HMA2701	50		300	
	$(I_F = 5 \text{ mA}, V_{CE} = 5 \text{ V})$		HMA2701A	150		300	
			HMA2701B	80		160	
	$(I_F = 5 \text{ mA}, V_{CE} = 5 \text{ V})$		HMA121	50		600	
			HMA121A	100		300	
			HMA121B	50		150	
			HMA121C	100		200	
			HMA121D	50		100	
			HMA121E	150		300	
			HMA121F	100		600	
$(I_F = 1 \text{ mA}, V_{CE} = 0.4 \text{ V})$	HMA121F	30					
$(I_F = 1 \text{ mA}, V_{CE} = 0.5 \text{ V})$	HMA124	100		1200			
$(I_F = 0.5 \text{ mA}, V_{CE} = 1.5 \text{ V})$	HMA124	50		—			
CTR Symmetry	$(I_F = \pm 5 \text{ mA}, V_{CE} = 5 \text{ V})$	—	HMAA2705	0.3		3.0	
Saturation Voltage	$(I_F = \pm 10 \text{ mA}, I_C = 2 \text{ mA})$	$V_{CE(SAT)}$	HMAA2705			0.3	V
			HMA2701			0.3	
	$(I_F = 10 \text{ mA}, I_C = 2 \text{ mA})$		HMA2701A			0.3	
			HMA2701B			0.3	
	$(I_F = 8 \text{ mA}, I_C = 2.4 \text{ mA})$		HMA121			0.4	
			HMA121A			0.4	
			HMA121B			0.4	
			HMA121C			0.4	
			HMA121D			0.4	
			HMA121E			0.4	
			HMA121F			0.4	
$(I_F = 1 \text{ mA}, I_C = 0.2 \text{ mA})$	HMA121F			0.4			
$(I_F = 1 \text{ mA}, I_C = 0.5 \text{ mA})$	HMA124			0.4			
Rise Time (Non-Saturated)	$(I_C = 2 \text{ mA}, V_{CE} = 5 \text{ V})$ $(R_L = 100\Omega)$	t_r			3		μs
Fall Time (Non-Saturated)	$(I_C = 2 \text{ mA}, V_{CE} = 5 \text{ V})$ $(R_L = 100\Omega)$	t_f			3		

ISOLATION CHARACTERISTICS

Characteristic	Test Conditions	Symbol	Device	Min	Typ**	Max	Unit
Steady State Isolation Voltage	(1 Minute)	V_{ISO}	All	3750			VRMS

** All typicals at $T_A = 25^\circ\text{C}$

TYPICAL PERFORMANCE CURVES

Fig. 1 Forward Current vs. Forward Voltage



Fig. 2 Collector Current vs. Forward Current



Fig. 3 Current Transfer Ratio vs. Forward Current



Fig. 4 Collector Current vs. Temperature



Fig. 5 Collector Current vs. Collector-Emitter Voltage



HMA121 Series

HMA124

HMA2701 Series

HMAA2705

Fig. 6 Collector Current vs. Collector-Emitter Voltage

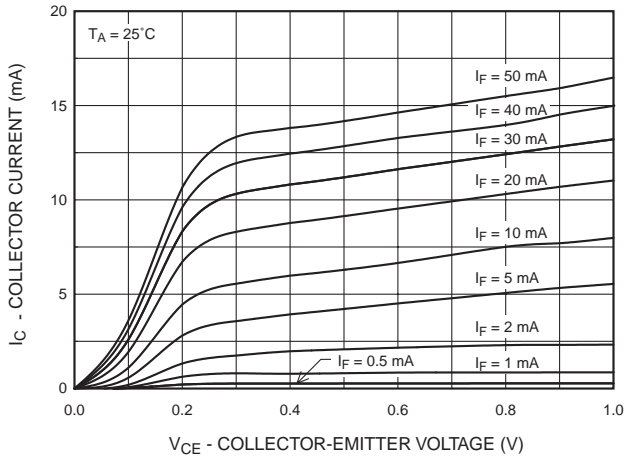

Fig. 7 Collector Dark Current vs. Temperature

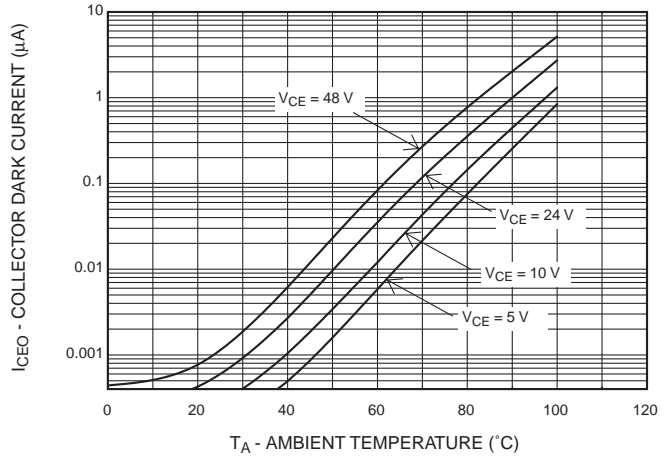

Fig. 8 Switching Time vs. Load Resistance

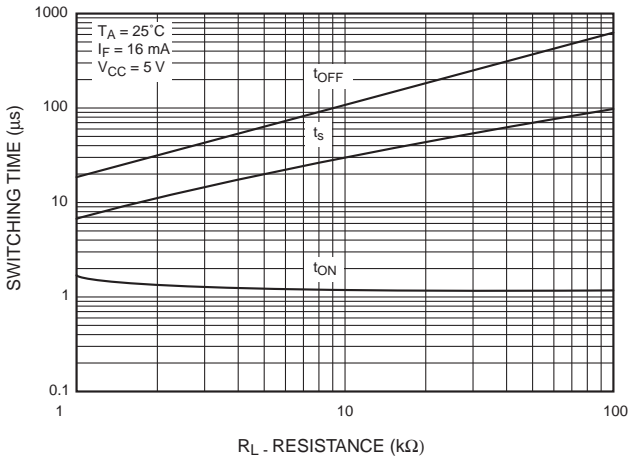
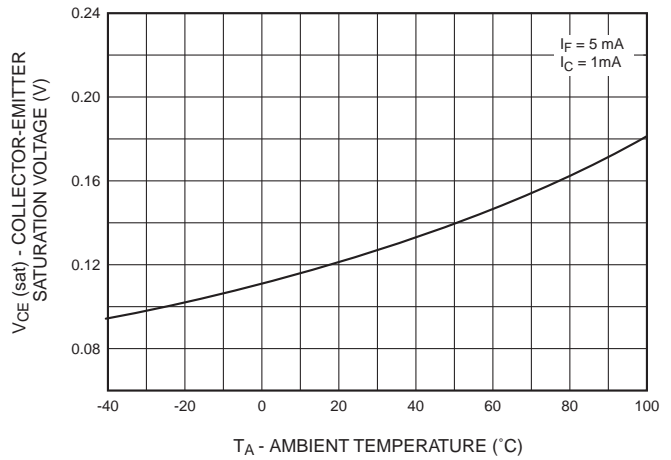

Fig. 9 Collector-Emitter Saturation Voltage vs. Temperature



HMA121 Series

HMA124

HMA2701 Series

HMAA2705

ORDERING INFORMATION

Option	Description
V	VDE Approved
R1	Tape and Reel (500 units)
R2	Tape and Reel (2500 units)
R3	Tape and Reel (500 units; unit 180° rotated)
R4	Tape and Reel (2500 units; unit 180° rotated)
R1V	Tape and Reel (500 units) and VDE Approved
R2V	Tape and Reel (2500 units) and VDE Approved
R3V	Tape and Reel (500 units; unit 180° rotated) and VDE Approved
R4V	Tape and Reel (2500 units; unit 180° rotated) and VDE Approved

MARKING INFORMATION



Definitions	
1	Fairchild logo
2	Device number
3	VDE mark (Note: Only appears on parts ordered with VDE option – See order entry table)
4	One digit year code
5	Two digit work week ranging from '01' to '53'
6	Assembly package code

HMA121 Series

HMA124

HMA2701 Series

HMAA2705



Description		Symbol	2.54 Pitch Dimensions (mm)
Tape Width		W	12.00±0.4
Tape Thickness		t	0.30±0.20
Sprocket Hole Pitch		P ₀	4.00±0.20
Sprocket Hole Dia.		D ₀	1.55±0.20
Sprocket Hole Location		E	1.75±0.20
Pocket Location		F	5.50±0.20
		P ₂	2.00±0.20
Pocket Pitch		P	8.00±0.20
Pocket Dimension		A ₀	4.40±0.20
		B ₀	7.30±0.20
		K ₀	2.30±0.20
Pocket Hole Dia.		D ₁	1.55±0.20
Cover Tape Width		W ₁	9.20
Cover Tape Thickness		d	0.065±0.02
Max. Component Rotation or Tilt			20° max
Devices Per Reel	R1		500
	R2		2500
Reel Diameter	R1		178 mm (7")
	R2		330 mm (13")

HMA121 Series

HMA124

HMA2701 Series

HMAA2705

Footprint Drawing for PCB Layout



Recommended Infrared Reflow Soldering Profile



- Peak reflow temperature: 230°C (package surface temperature) for 30 seconds
- Time of temperature higher than 210°C: 60 seconds or less
- One time soldering reflow is recommended

HMA121 Series

HMA124

HMA2701 Series

HMAA2705

DISCLAIMER

FAIRCHILD SEMICONDUCTOR RESERVES THE RIGHT TO MAKE CHANGES WITHOUT FURTHER NOTICE TO ANY PRODUCTS HEREIN TO IMPROVE RELIABILITY, FUNCTION OR DESIGN. FAIRCHILD DOES NOT ASSUME ANY LIABILITY ARISING OUT OF THE APPLICATION OR USE OF ANY PRODUCT OR CIRCUIT DESCRIBED HEREIN; NEITHER DOES IT CONVEY ANY LICENSE UNDER ITS PATENT RIGHTS, NOR THE RIGHTS OF OTHERS.

LIFE SUPPORT POLICY

FAIRCHILD'S PRODUCTS ARE NOT AUTHORIZED FOR USE AS CRITICAL COMPONENTS IN LIFE SUPPORT DEVICES OR SYSTEMS WITHOUT THE EXPRESS WRITTEN APPROVAL OF THE PRESIDENT OF FAIRCHILD SEMICONDUCTOR CORPORATION. As used herein:

1. Life support devices or systems are devices or systems which, (a) are intended for surgical implant into the body, or (b) support or sustain life, and (c) whose failure to perform when properly used in accordance with instructions for use provided in the labeling, can be reasonably expected to result in a significant injury of the user.
2. A critical component in any component of a life support device or system whose failure to perform can be reasonably expected to cause the failure of the life support device or system, or to affect its safety or effectiveness.

Looking for pricing, stock, or lifecycle information?

Click below to explore more details on WIN SOURCE:

- ⊖ [View HMA121CR1 on WIN SOURCE](#)
- ⊖ [Fairchild/ON Semiconductor Information](#)

Optimize Your Supply Chain with WIN SOURCE Solutions

- ✓ Global Sourcing Solution
- ✓ Obsolete Management
- ✓ Cost Control Management
- ✓ Shortage Management
- ✓ Alternative Solution
- ✓ Excess Inventory Management