



**THE DATASHEET OF  
SG3526BDW**



# REGULATING PULSE WIDTH MODULATOR

## DESCRIPTION

The SG1526B is a high-performance pulse width modulator for switching power supplies which offers improved functional and electrical characteristics over the industry-standard SG1526. A direct pin-for-pin replacement for the earlier device with all its features, it incorporates the following enhancements: a bandgap reference circuit for improved regulation and drift characteristics, improved undervoltage lockout, lower temperature coefficients on oscillator frequency and current-sense threshold, tighter tolerance on softstart time, much faster SHUTDOWN response, improved double-pulse suppression logic for higher speed operation, and an improved output driver design with low shoot-through current, and faster rise and fall times. This versatile device can be used to implement single-ended or push-pull switching regulators of either polarity, both transformerless and transformer-coupled. The SG1526B is specified for operation over the full military ambient temperature range of -55°C to 150°C. The SG2526B is characterized for the industrial range of -25°C to 150°C, and the SG3526B is designed for the commercial range of 0°C to 125°C.

## FEATURES

- 8V to 35V Operation
- 5V Low drift 1% Bandgap Reference
- 1Hz to 500kHz Oscillator Range
- Dual 100mA Source/Sink
- Digital Current Limiting
- Double Pulse Suppression
- Programmable Deadtime
- Improved Undervoltage Lockout
- Single Pulse Metering
- Programmable Soft-start
- Wide current Limit Common Mode Range
- TTL/CMOS Compatible Logic Ports
- Symmetry Correction Capability
- Guaranteed 6 Unit Synchronization
- Shoot-through Currents Less than 100mA
- Improved Shutdown Delay
- Improved Rise and Fall Time

## HIGH RELIABILITY FEATURES

- Available To MIL-STD-883, ¶ 1.2.1
- Available to DSCC - Standard Microcircuit Drawing (SMD)
- MIL-M38510/12603BVA - SG1526BJ-JAN
- Radiation data available
- MSC-AMS Level "S" Processing Available

## BLOCK DIAGRAM

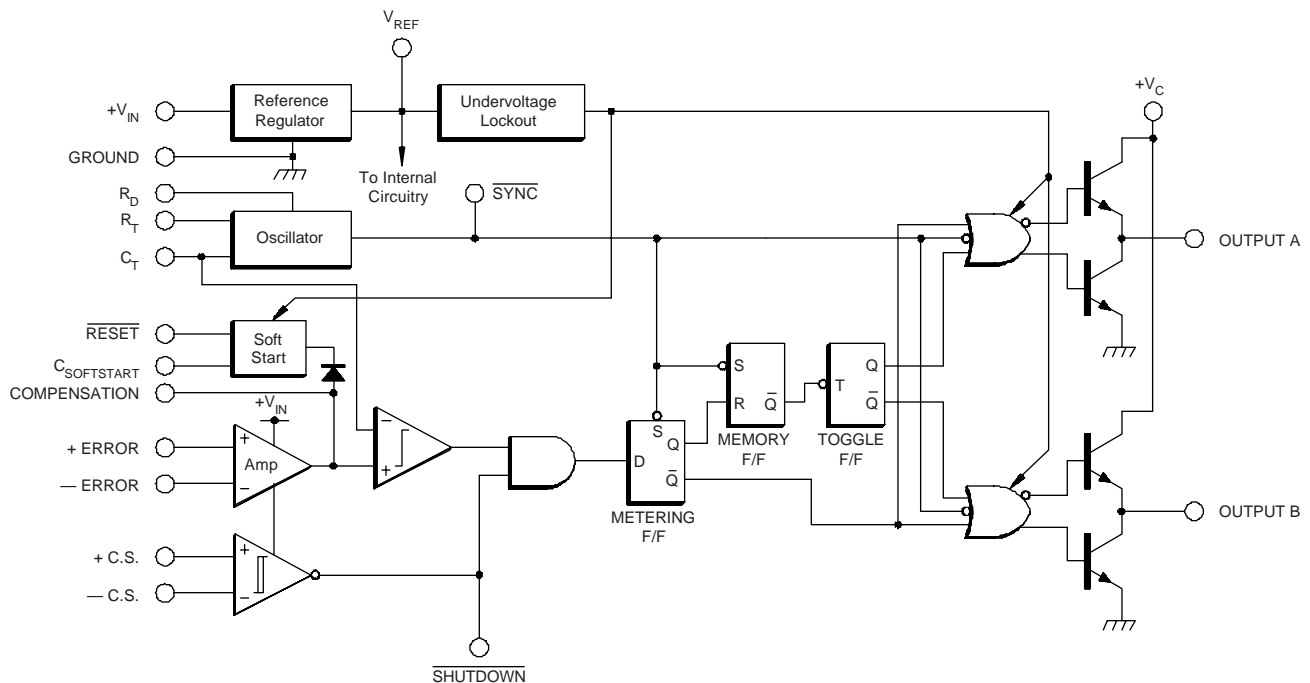

### ABSOLUTE MAXIMUM RATINGS (Note 1)

Input Voltage ( $V_{IN}$ ) .....	40V
Collector Supply Voltage ( $V_C$ ) .....	40V
Logic Inputs .....	-0.3V to 5.5V
Analog Inputs .....	-0.3V to $V_{IN}$
Source/Sink Load Current (each output) .....	200mA
Reference Load Current .....	50mA

Logic Sink Current .....	15mA
Operating Junction Temperature	
Hermetic (J, L Packages) .....	150°C
Plastic (N, DW Packages) .....	150°C
Storage Temperature Range .....	-65°C to 150°C
Lead Temperature (Soldering, 10 Seconds) .....	300°C
RoHS Peak Package Solder Reflow Temp. (40 sec. max. exp.).....	260°C (+0, -5)

Note 1. Exceeding these ratings could cause damage to the device.

### THERMAL DATA

J Package:

Thermal Resistance-Junction to Case, $\theta_{JC}$ .....	25°C/W
Thermal Resistance-Junction to Ambient, $\theta_{JA}$ .....	70°C/W

N Package:

Thermal Resistance-Junction to Case, $\theta_{JC}$ .....	30°C/W
Thermal Resistance-Junction to Ambient, $\theta_{JA}$ .....	60°C/W

DW Package:

Thermal Resistance-Junction to Case, $\theta_{JC}$ .....	35°C/W
Thermal Resistance-Junction to Ambient, $\theta_{JA}$ .....	90°C/W

L Package:

Thermal Resistance-Junction to Case, $\theta_{JC}$ .....	35°C/W
Thermal Resistance-Junction to Ambient, $\theta_{JA}$ .....	120°C/W

Note A. Junction Temperature Calculation:  $T_J = T_A + (P_D \times \theta_{JA})$ .

Note B. The above numbers for  $\theta_{JC}$  are maximums for the limiting thermal resistance of the package in a standard mounting configuration. The  $\theta_{JA}$  numbers are meant to be guidelines for the thermal performance of the device/pc-board system. All of the above assume no ambient airflow.

### RECOMMENDED OPERATING CONDITIONS (Note 2)

Input Voltage .....	8V to 35V
Collector Supply Voltage .....	4.5V to 35V
Sink/Source Load Current (each output) .....	0 to 100mA
Reference Load Current .....	0 to 20mA
Oscillator Frequency Range .....	1Hz to 500kHz
Oscillator Timing Resistor .....	2k $\Omega$ to 150k $\Omega$

Oscillator Timing Capacitor .....	470pF to 20 $\mu$ F
Available Deadtime Range at 40kHz .....	5% to 50%
Operating Junction Temperature Range:	
SG1526B .....	-55°C to 125°C
SG2526B .....	-25°C to 85°C
SG3526B .....	0°C to 70°C

Note 2. Range over which the device is functional.

### ELECTRICAL CHARACTERISTICS

(Unless otherwise specified, these specifications apply over the operating ambient temperatures for SG1526B with  $-55^\circ\text{C} \leq T_A \leq 125^\circ\text{C}$ , SG2526B with  $-25^\circ\text{C} \leq T_A \leq 85^\circ\text{C}$ , SG3526B with  $0^\circ\text{C} \leq T_A \leq 70^\circ\text{C}$ , and  $V_{IN} = 15\text{V}$ . Low duty cycle pulse testing techniques are used which maintains junction and case temperatures equal to the ambient temperature.)

Parameter	Test Conditions	SG1526B/2526B			SG3526B			Units
		Min.	Typ.	Max.	Min.	Typ.	Max.	
<b>Reference Section (Note 3)</b>								
Output Voltage	$T_J = 25^\circ\text{C}$	4.95	5.00	5.05	4.90	5.00	5.10	V
Line Regulation	$V_{IN} = 8$ to 35V		7	10		10	20	mV
Load Regulation	$I_L = 0$ to 20mA		10	20		10	25	mV
Temperature Stability (Note 9)	Over Operating $T_J$		15	50		15	50	mV
Total Output Voltage Range (Note 9)		4.90	5.00	5.10	4.85	5.00	5.15	V
Short Circuit Current	$V_{REF} = 0\text{V}$	25	50	125	25	50	125	mA
<b>Undervoltage Lockout Section</b>								
RESET Output Voltage	$V_{REF} = 3.8\text{V}$		0.2	0.4		0.2	0.4	V
RESET Output Voltage	$V_{REF} = 4.8\text{V}$	2.4	4.8		2.4	4.8		V

**ELECTRICAL CHARACTERISTICS (continued)**

Parameter	Test Conditions	SG1526B/2526B			SG3526B			Units
		Min.	Typ.	Max.	Min.	Typ.	Max.	
<b>Oscillator Section (Note 4)</b>								
Initial Accuracy	$T_J = 25^\circ\text{C}$		$\pm 3$	$\pm 8$		$\pm 3$	$\pm 8$	%
Voltage Stability	$V_{IN} = 8 \text{ to } 35\text{V}$		0.5	1.0		0.5	1.0	%
Temperature Stability (Note 9)	Over Operating $T_J$		7	10		3	5	%
Minimum Frequency (Note 9)	$R_T = 150\text{k}\Omega$ , $C_T = 20\mu\text{F}$			1.0			1.0	Hz
Maximum Frequency	$R_T = 2\text{k}\Omega$ , $C_T = 470\text{pF}$	500			500			kHz
Sawtooth Peak Voltage	$V_{IN} = 35\text{V}$	2.5	3.0	3.5	2.5	3.0	3.5	V
Sawtooth Valley Voltage	$V_{IN} = 8\text{V}$	0.5	1.0	1.1	0.5	1.0	1.1	V
SYNC Pulse Width	$R_L = 2.0\text{k}\Omega$ to $V_{REF}$		1.0	2		1.0	2	$\mu\text{s}$
<b>Error Amplifier Section (Note 5)</b>								
Input Offset Voltage	$R_S \leq 2\text{k}\Omega$		2	5		2	10	mV
Input Bias Current			-350	-1000		-350	-2000	nA
Input Offset Current			35	100		35	200	nA
DC Open Loop Gain	$R_L \geq 10\text{M}\Omega$	64	72		60	72		dB
High Output Voltage	$V_{PIN1} - V_{PIN2} \geq 150\text{mV}$ , $I_{SOURCE} = 100\mu\text{A}$	3.6	4.2		3.6	4.2		V
Low Output Voltage	$V_{PIN2} - V_{PIN1} \geq 150\text{mV}$ , $I_{SINK} = 100\mu\text{A}$		0.2	0.4		0.2	0.4	V
Common Mode Rejection	$R_S \leq 2\text{k}\Omega$	70	94		70	94		dB
Supply Voltage Rejection	$V_{IN} = 8\text{V}$ to $35\text{V}$	66	80		66	80		dB
<b>PWM Comparator Section (Note 4)</b>								
Minimum Duty Cycle	$V_{COMPENSATION} = 0.4\text{V}$			0			0	%
Maximum Duty Cycle	$V_{COMPENSATION} = 3.6\text{V}$	45	49		45	49		%
<b>Digital Ports (SYNC, SHUTDOWN, and RESET)</b>								
HIGH Output Voltage	$I_{SOURCE} = 40\mu\text{A}$	2.4	4		2.4	4		V
LOW Output Voltage	$I_{SINK} = 3.6\text{mA}$		0.2	0.4		0.2	0.4	V
HIGH Input Current	$V_{IH} = 2.4\text{V}$		-125	-200		-125	-200	$\mu\text{A}$
LOW Input Current	$V_{IL} = 0.4\text{V}$		-225	-360		-225	-360	$\mu\text{A}$
SHUTDOWN Delay to Output	(Note 9)			200			200	ns
<b>Current Limit Comparator Section (Note 6)</b>								
Sense Voltage	$R_S \leq 50\Omega$	90	100	110	80	100	120	mV
Input Bias Current			-3	-10		-3	-10	$\mu\text{A}$
Delay to Output (Note 9)				400			400	ns
<b>Soft-Start Section</b>								
Error Clamp Voltage	$\overline{\text{RESET}} = 0.4\text{V}$		0.1	0.4		0.1	0.4	V
$C_S$ Charging Current	$\overline{\text{RESET}} = 2.4\text{V}$	50	100	150	50	100	150	$\mu\text{A}$
<b>Output Drivers (each output) (Note 7)</b>								
HIGH Output Voltage	$I_{SOURCE} = 20\text{mA}$	12.5	13.5		12.5	13.5		V
	$I_{SOURCE} = 100\text{mA}$	12	13		12	13		V
LOW Output Voltage	$I_{SINK} = 20\text{mA}$		0.2	0.3		0.2	0.3	V
	$I_{SINK} = 100\text{mA}$		1.2	2		1.2	2	V
Collector Leakage	$V_C = 40\text{V}$		50	150		50	150	$\mu\text{A}$
Rise Time	$C_L = 1000\text{pF}$		0.3	0.4		0.3	0.4	$\mu\text{s}$
Fall Time	$C_L = 1000\text{pF}$		0.1	0.15		0.1	0.15	$\mu\text{s}$
<b>Power Consumption Section (Note 8)</b>								
Standby Current	SHUTDOWN = 0.4V		18	30		18	30	mA

 Note 3.  $I_L = 0\text{mA}$ 

 Note 4.  $F_{OSC} = 40\text{kHz}$  ( $R_T = 4.12\text{k}\Omega \pm 1\%$ ,  $C_T = .01\mu\text{F} \pm 1\%$ ,  $R_D = 0\Omega$ )

 Note 5.  $V_{CM} = 0$  to  $5.2\text{V}$ 

 Note 6.  $V_{CM} = 0$  to  $12\text{V}$ 

 Note 7.  $V_C = 15\text{V}$ 

 Note 8.  $V_{IN} = 35\text{V}$ 

Note 9. These parameters, although guaranteed over the recommended operating conditions, are not tested in production.

## CHARACTERISTIC CURVES

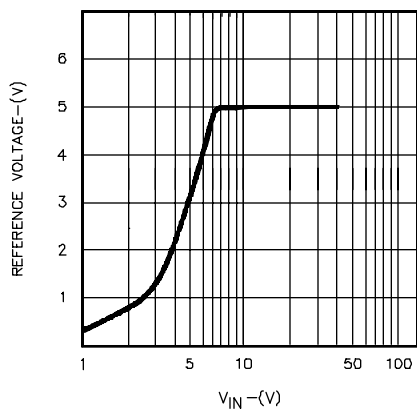

FIGURE 1.  
REFERENCE VOLTAGE VS. SUPPLY VOLTAGE

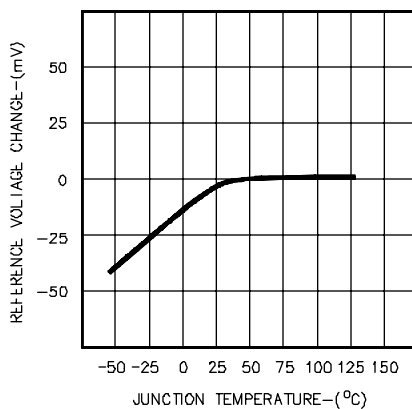

FIGURE 2.  
REFERENCE TEMPERATURE STABILITY

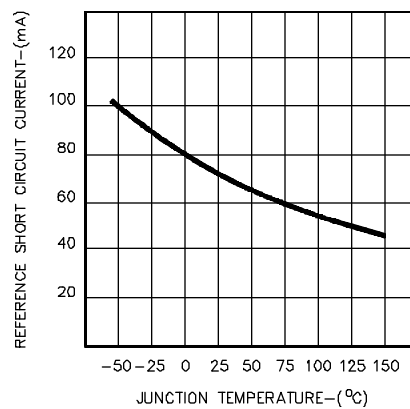

FIGURE 3.  
REFERENCE SHORT CIRCUIT

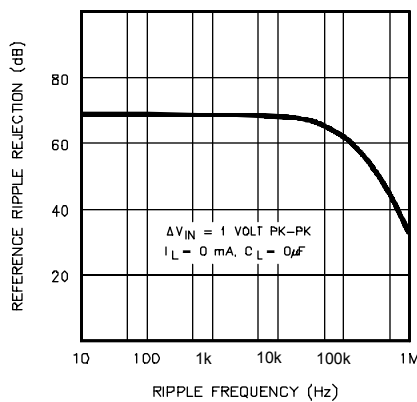

FIGURE 4.  
REFERENCE RIPPLE REJECTION

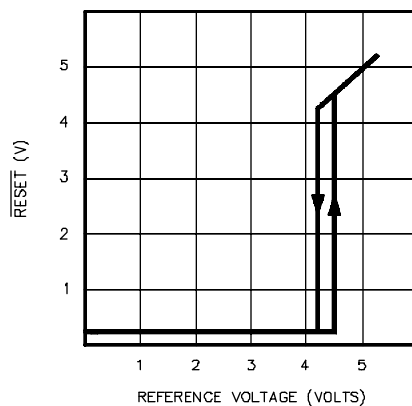

FIGURE 5.  
UNDER VOLTAGE LOCKOUT

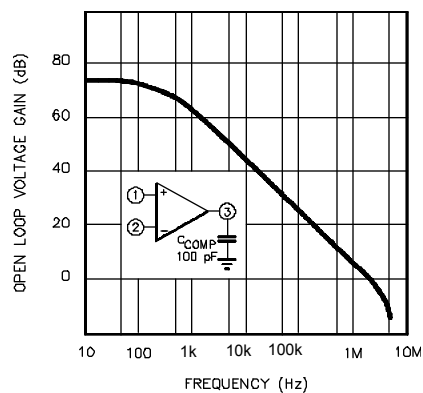

FIGURE 6.  
ERROR AMPLIFIER OPEN LOOP GAIN  
VS. FREQUENCY

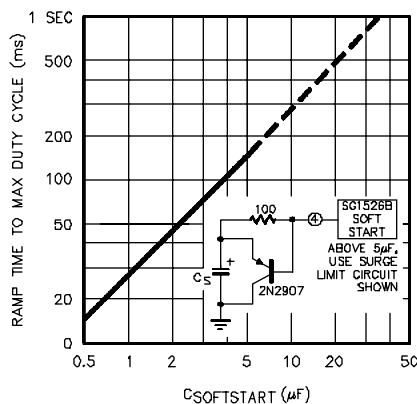

FIGURE 7.  
SOFTSTART TIME CONSTANT VS.  $C_S$

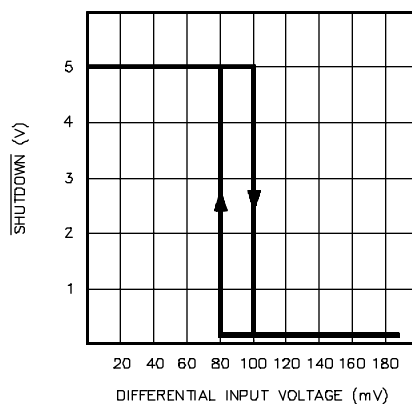

FIGURE 8.  
CURRENT LIMIT TRANSFER FUNCTION

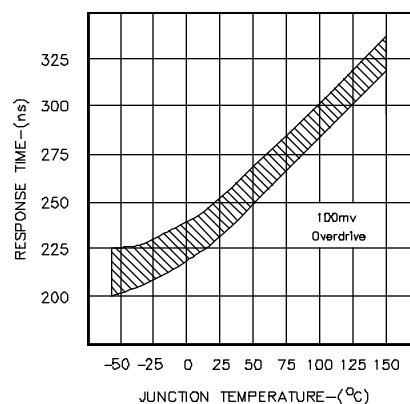

FIGURE 9.  
COMPARATOR INPUT TO DRIVER OUTPUT DELAY

### CHARACTERISTIC CURVES (continued)

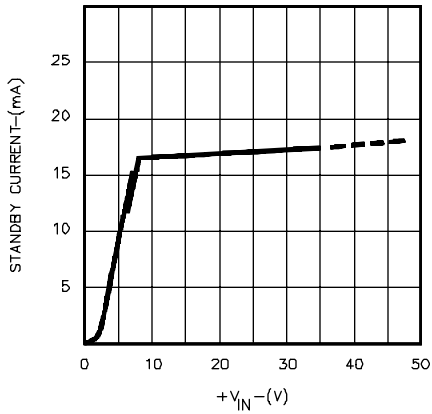

FIGURE 10. STANDBY CURRENT VS. SUPPLY VOLTAGE

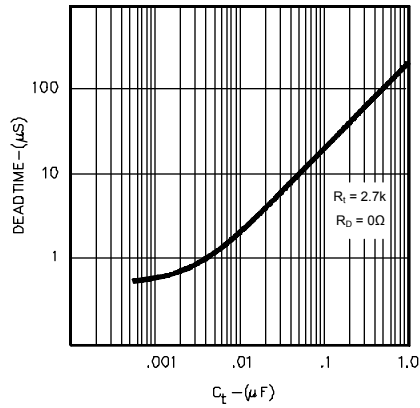

FIGURE 11. OUTPUT DRIVER DEADTIME VS.  $C_t$  VALUE

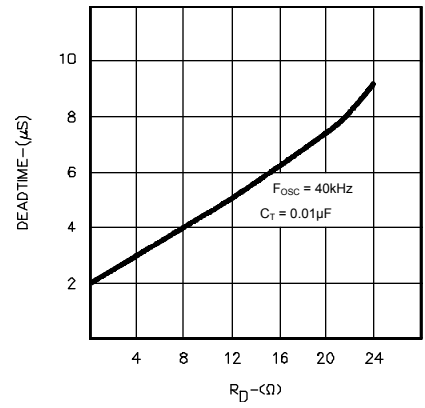

FIGURE 12. OUTPUT DRIVER DEADTIME VS.  $R_D$  VALUE

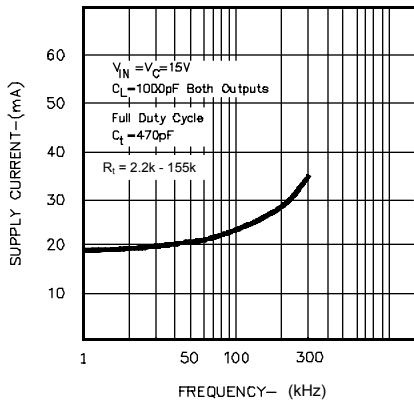

FIGURE 13. SUPPLY CURRENT VS. OUTPUT FREQUENCY

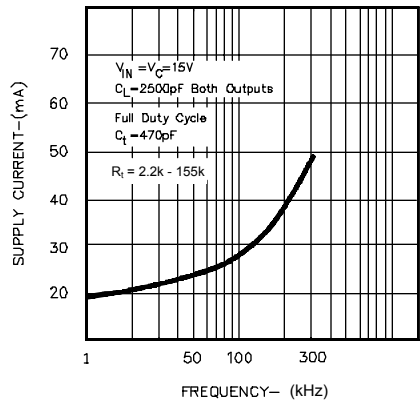

FIGURE 14. SUPPLY CURRENT VS. OUTPUT FREQUENCY

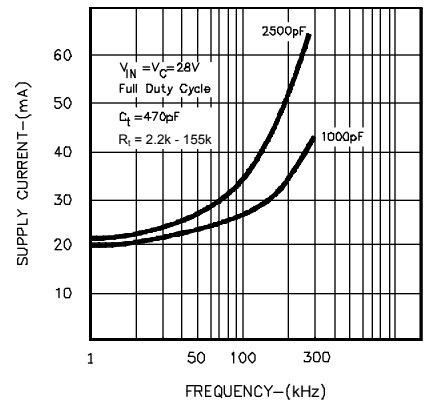

FIGURE 15. SUPPLY CURRENT VS. OUTPUT FREQUENCY

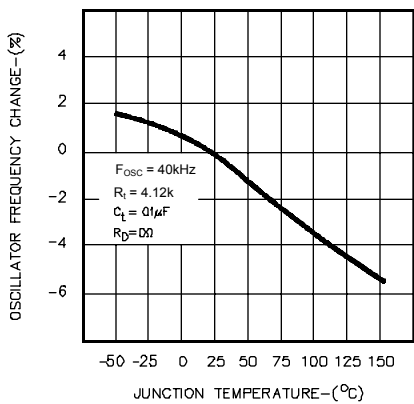

FIGURE 16. OSCILLATOR FREQUENCY TEMPERATURE STABILITY

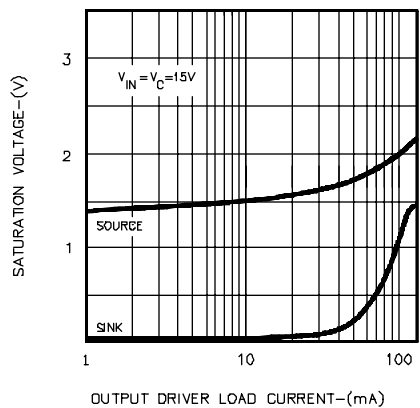

FIGURE 17. OUTPUT DRIVER SATURATION VOLTAGE

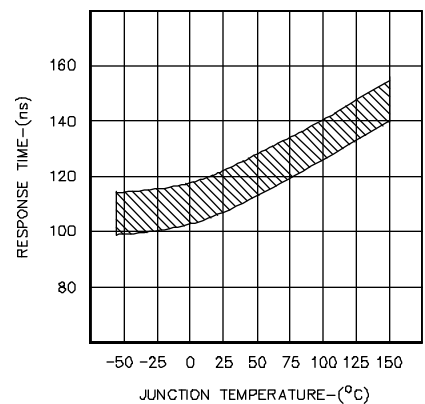

FIGURE 18. SHUTDOWN INPUT TO DRIVER OUTPUT DELAY

## CHARACTERISTIC CURVES (continued)

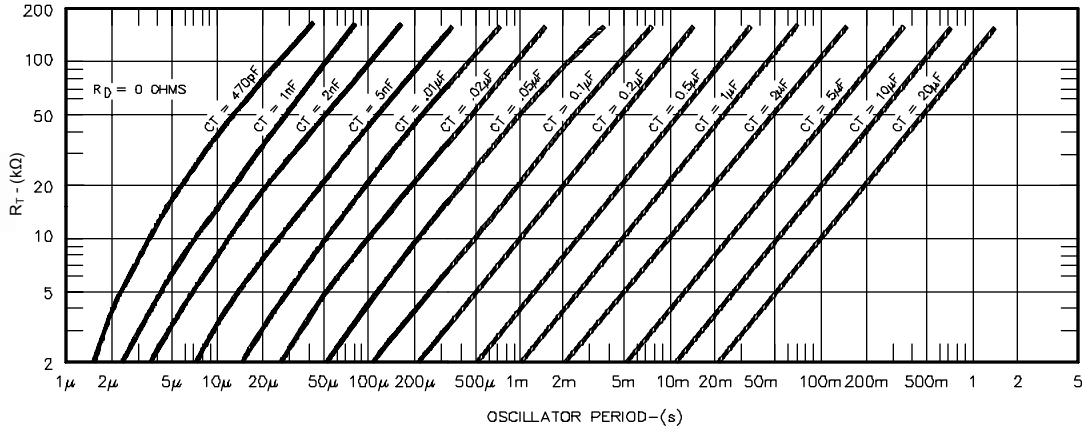

FIGURE 19.  
OSCILLATOR PERIOD VS.  $R_T$  AND  $C_T$

## APPLICATION INFORMATION

### VOLTAGE REFERENCE

The reference regulator of the SG1526B is a “band-gap” type; that is, the precision +5 volt output is derived from the very predictable base-emitter voltage of an NPN transistor. Since this is a sub-surface phenomenon, the resulting output exhibits excellent stability compared to earlier surface-breakdown Zener designs.

The reference output is stabilized at input voltages as low as +8 volts, and can provide up to 20mA of load current to external circuitry. An external PNP transistor can be used to boost the available current to many hundreds of mA. A rugged low-frequency audio-type transistor should be used, and lead lengths between the PWM and transistor should be as short as possible to minimize the risk of oscillation.

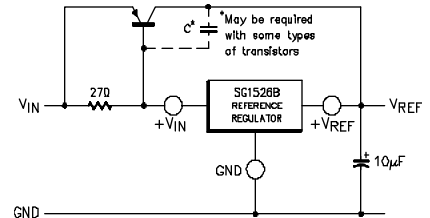

FIGURE 20.  
EXTENDING REFERENCE OUTPUT CURRENT

### UNDERVOLTAGE LOCKOUT

The undervoltage lockout circuit protects the SG1526B and the power devices it controls from inadequate supply voltage. If  $+V_{IN}$  is too low, the circuit disables the output drivers and holds the RESET pin LOW. This prevents spurious output pulses while the control circuitry is stabilizing, and holds the soft-start timing capacitor in a discharged state.

The circuit consists of a merged bandgap reference and comparator circuit which is active when the reference voltage has risen to  $2V_{BE}$  or 1.2 volts at 25°C. When the reference voltage rises to approximately +4.4 volts, the circuit enables the output drivers and releases the RESET pin, allowing a normal softstart. The comparator has 200mV of hysteresis to minimize oscillation at the trip point. When  $+V_{IN}$  to the PWM is removed and the reference drops to +4.2 volts, the undervoltage circuit pulls RESET LOW again. The soft-start capacitor is immediately discharged, and the PWM is ready for another soft-start cycle.

The SG1526B can operate from a +5 volt supply regulated to within  $\pm 4\%$  by connecting the  $V_{REF}$  pin to the  $+V_{IN}$  pin.

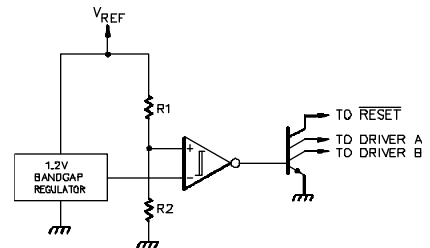

FIGURE 21.  
SIMPLIFIED UNDERVOLTAGE LOCKOUT

### SOFT-START CIRCUIT

The soft-start circuit protects the power transistors and rectifier diodes from high current surges during power supply turn-on. When supply voltage is first applied to the SG1526B, the undervoltage lockout circuit holds RESET LOW with Q3. Q1 is turned on, which holds the soft-start capacitor voltage at zero. The second collector of Q1 clamps the output of the error amplifier to ground, guaranteeing zero duty cycle at the driver outputs. When the supply voltage reaches normal operating range, RESET will go HIGH. Q1 turns off, allowing the internal 100μA current source to charge  $C_S$ . Q2 clamps the error amplifier output to  $1.0 V_{BE}$  above the voltage on  $C_S$ . As the soft-start voltage ramps up to +5 volts, the duty cycle of the PWM linearly increases to whatever value the voltage regulation loop requires for an error null. Figure 7 gives the timing relationship between  $C_S$  ramp time to 100% duty cycle.

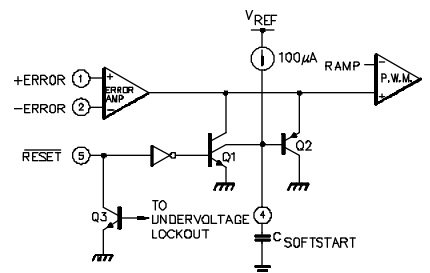

FIGURE 22.  
SOFT-START CIRCUIT SCHEMATIC

## APPLICATION INFORMATION (continued)

### DIGITAL CONTROL PORTS

The three digital control ports of the SG1526B are bi-directional. Each pin can drive TTL and 5 volt CMOS logic directly, up to a fan-out of 10 low-power Schottky gates. Each pin can also be directly driven by open-collector TTL, open-drain CMOS, and open-collector voltage comparators, fan-in is equivalent to 1 low-power Schottky gate. Each port is normally HIGH; the pin is pulled LOW to activate the particular function. Driving  $\overline{\text{SYNC}}$  LOW initiates a discharge cycle in the oscillator. Pulling  $\overline{\text{SHUTDOWN}}$  LOW immediately inhibits all PWM output pulses. Holding  $\overline{\text{RESET}}$  LOW discharges the soft-start capacitor. The logic threshold is +1.1 volts at +25°C. Noise immunity can be gained at the expense of fan-out with an external 2k pull-up resistor to +5V.

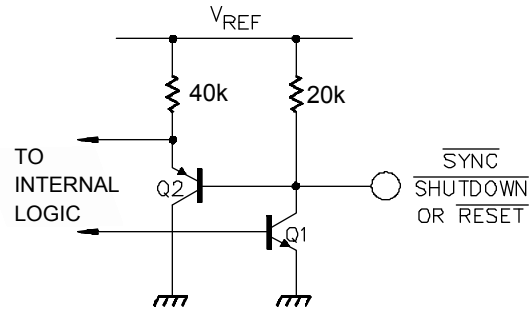

FIGURE 23  
DIGITAL CONTROL PORT SCHEMATIC

### OSCILLATOR

The oscillator is programmed for frequency and dead time with three components:  $R_T$ ,  $C_T$ , and  $R_D$ . Two waveforms are generated: a sawtooth waveform at pin 10 for pulse width modulation, and a logic clock at pin 12. The following procedure is recommended for choosing timing values:

1. With  $R_D = 0\Omega$  (pin 11 shorted to ground) select values for  $R_T$  and  $C_T$  from Figure 19 to give the desired oscillator period. Remember that the frequency at each driver output is half the oscillator frequency, and the frequency at the  $+V_C$  terminal is the same as the oscillator frequency.
2. If more dead time is required, select a larger value of  $R_D$  using Figure 12 as a guide. At 40 kHz dead time increases by 300 ns/ $\Omega$ .
3. Increasing the dead time will cause the oscillator frequency to decrease slightly. Go back and decrease the value of  $R_T$  slightly to bring the frequency back to the nominal design value.

The SG1526B can be synchronized to an external logic clock by programming the oscillator to free-run at a frequency 10% slower than the sync frequency. A periodic LOW logic pulse approximately 0.5  $\mu\text{Sec}$  wide at the  $\overline{\text{SYNC}}$  pin will then lock the oscillator to the external frequency.

Multiple devices can be synchronized together by programming one master unit for the desired frequency, and then sharing its sawtooth and clock waveforms with the slave units. All  $C_T$  terminals are connected to the  $C_T$  pin of the master, and all  $\overline{\text{SYNC}}$  terminals are likewise connected to the  $\overline{\text{SYNC}}$  pin of the master. Slave  $R_T$  terminals should not be left open; at least 50k should be connected from each pin to ground. Slave  $R_D$  terminals may be either left open or grounded.

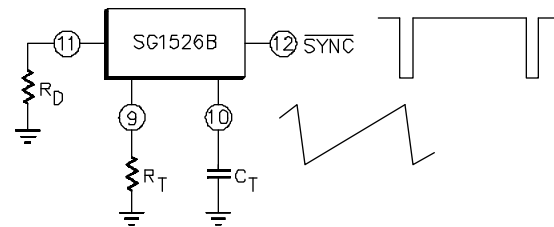

FIGURE 24.  
OSCILLATOR CONNECTIONS AND WAVEFORMS

### ERROR AMPLIFIER

The error amplifier is a transconductance design, with an output impedance of 2 megohms. Since all voltage gain takes place at the output pin, the open-loop gain/frequency characteristics can be controlled with shunt reactance to ground. When compensated for unity-gain stability with 100 pF, the amplifier has an open-loop pole at 400 Hz.

The input connections to the error amplifier and determined by the polarity of the switching supply output voltage. For positive supplies, the common-mode voltage is +5.0 volts and the feedback connections in Figure 25A are used. With negative supplies, the common-mode voltage is ground and the feedback divider is connected between the negative output and the +5.0 volt reference voltage, as shown in Figure 25B.

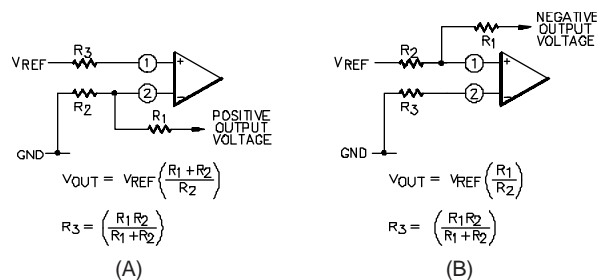

FIGURE 25.  
ERROR AMPLIFIER CONNECTIONS

## APPLICATION INFORMATION (continued)

### OUTPUT DRIVERS

The totem-pole output drivers of the SG1526B are designed to source and sink 100mA continuously and 200mA peak. Loads can be driven either from the output pins 13 and 16,

or from the +V<sub>C</sub> pin, as required. Curves for the saturation voltage at these outputs as a function of load current are found in Figure 17.

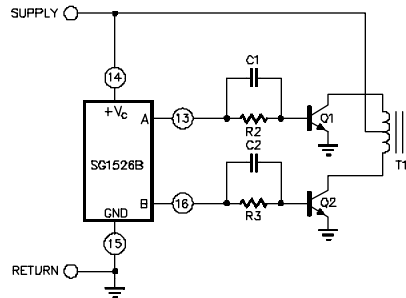

FIGURE 26. PUSH-PULL CONFIGURATION

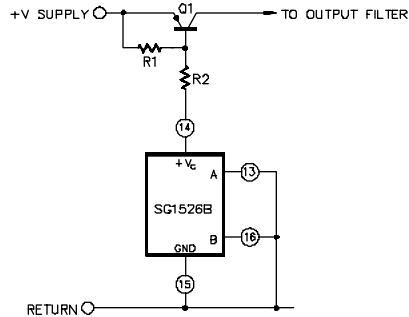

FIGURE 27. SINGLE-ENDED CONFIGURATION

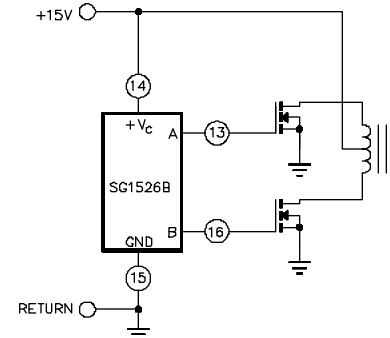
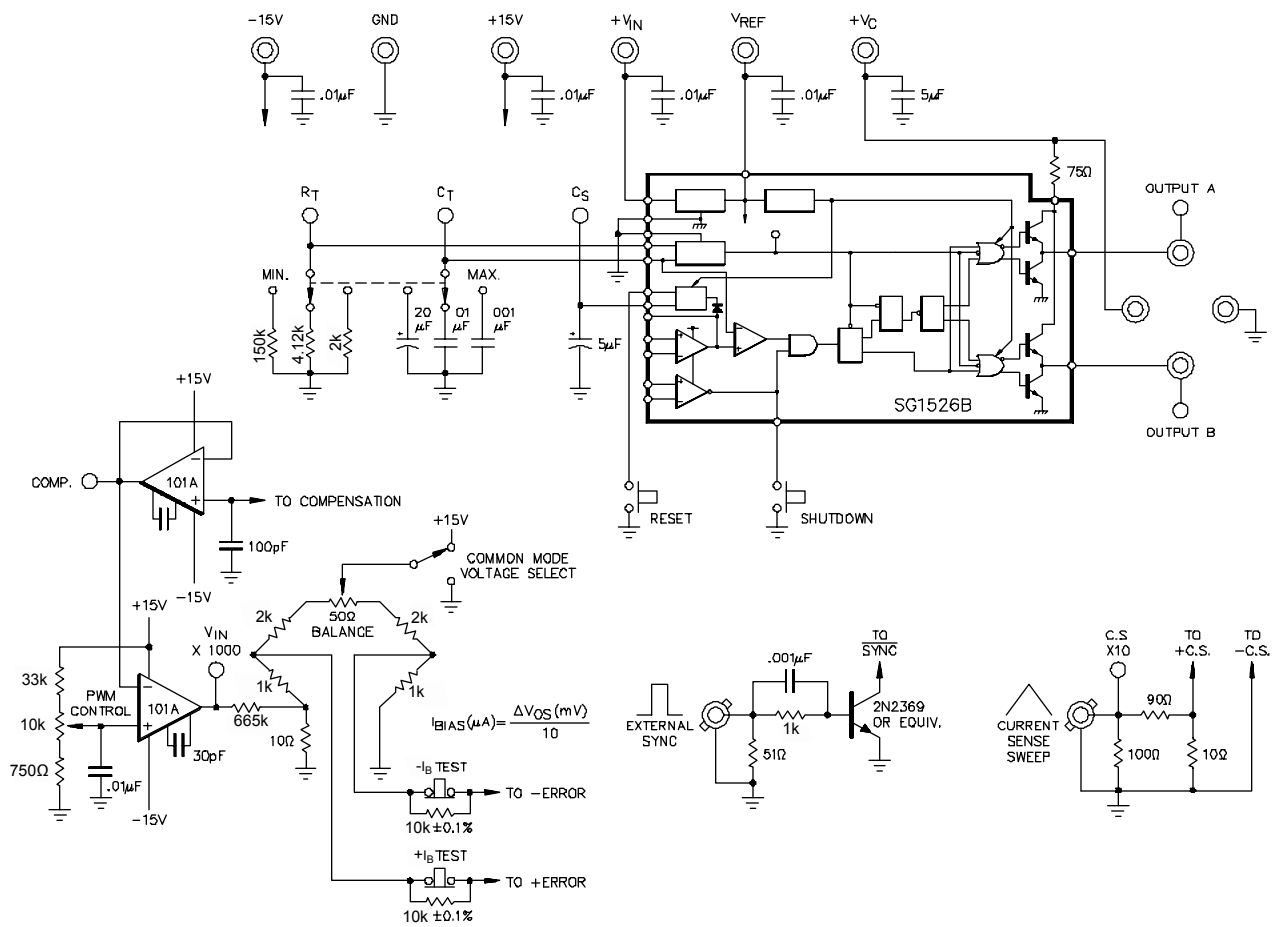
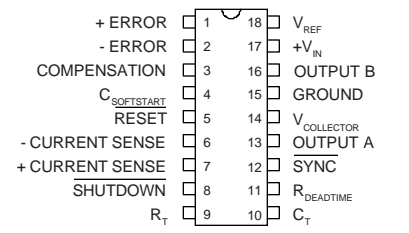
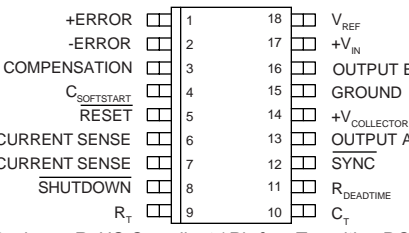
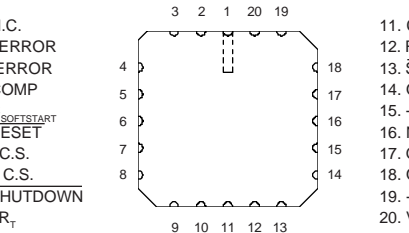

FIGURE 28. DRIVING N-CHANNEL POWER MOSFETS

### SG1526B LAB TEST FIXTURE



### CONNECTION DIAGRAMS & ORDERING INFORMATION (See Notes Below)

Package	Part No.	Ambient Temperature Range	Connection Diagram
18-PIN CERAMIC DIP J - PACKAGE	SG1526BJ-883B SG1526BJ-JAN SG1526BJ-DESC SG1526BJ SG2526BJ SG3526BJ	-55°C to 125°C -55°C to 125°C -55°C to 125°C -55°C to 125°C -25°C to 85°C 0°C to 70°C	 <p>N Package: RoHS Compliant / Pb-free Transition DC: 0503 N Package: RoHS / Pb-free 100% Matte Tin Lead Finish</p>
18-PIN PLASTIC DIP N - PACKAGE	SG2526BN SG3526BN	-25°C to 85°C 0°C to 70°C	
18-PIN WIDE BODY PLASTIC SOIC DW - PACKAGE	SG2526BDW SG3526BDW	-25°C to 85°C 0°C to 70°C	 <p>DW Package: RoHS Compliant / Pb-free Transition DC: 0516 DW Package: RoHS / Pb-free 100% Matte Tin Lead Finish</p>
20-PIN CERAMIC LEADLESS CHIP CARRIER L- PACKAGE	SG1526BL-883B SG1526BL	-55°C to 125°C -55°C to 125°C	 <p>1. N.C. 2. +ERROR 3. -ERROR 4. COMP 5. C<sub>SOFTSTART</sub> 6. RESET 7. - C.S. 8. + C.S. 9. SHUTDOWN 10. R<sub>T</sub></p> <p>11. C<sub>T</sub> 12. R<sub>DEADTIME</sub> 13. SYNC 14. OUTPUT A 15. +V<sub>COLLECTOR</sub> 16. N.C. 17. GROUND 18. OUTPUT B 19. +V<sub>IN</sub> 20. V<sub>REF</sub></p>

Note 1. Contact factory for JAN and DESC product availability.

Note 2. All parts are viewed from the top.

Note 3. Hermetic Packages J and L use Pb37/SN63 hot solder lead finish, contact factory for availability of RoHS versions.

## PACKAGE OUTLINE DIMENSIONS

Controlling dimensions are in inches, metric equivalents are shown for general information.

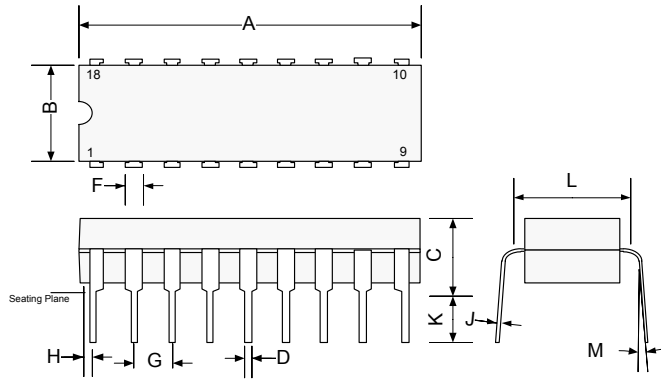

DIM	MILLIMETERS		INCHES	
	MIN	MAX	MIN	MAX
A	-	24.38	-	0.960
B	5.59	7.11	0.220	0.280
C	-	5.08	-	0.200
D	0.38	0.51	0.015	0.020
F	1.02	1.77	0.040	0.070
G	2.54 BSC		0.100 BSC	
H	-	2.03	-	0.080
J	0.20	0.38	0.008	0.015
K	3.18	5.08	0.125	0.200
L	7.37	7.87	0.290	0.310
M	-	15°	-	15°

**Note:** Dimensions do not include protrusions; these shall not exceed 0.155mm (0.006") on any side. Lead dimension shall not include solder coverage.

Figure 29 · J 18-Pin CERDIP Package Dimensions

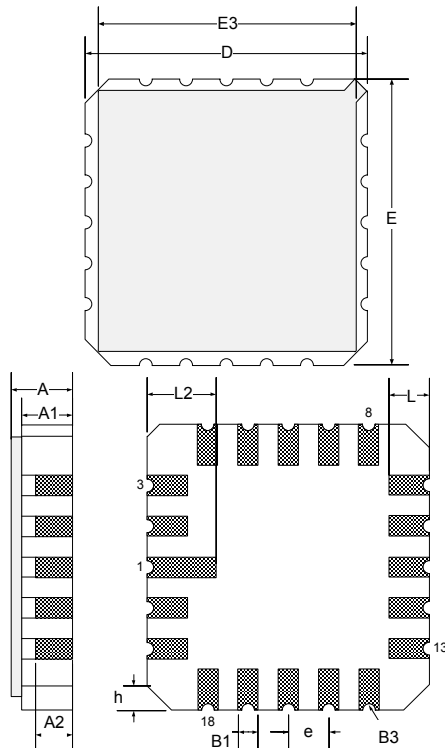

Dim	MILLIMETERS		INCHES	
	MIN	MAX	MIN	MAX
D/E	8.64	9.14	0.340	0.360
E3	-	8.128	-	0.320
e	1.270 BSC		0.050 BSC	
B1	0.635 TYP		0.025 TYP	
L	1.02	1.52	0.040	0.060
A	1.626	2.286	0.064	0.090
h	1.016 TYP		0.040 TYP	
A1	1.372	1.68	0.054	0.066
A2	-	1.168	-	0.046
L2	1.91	2.41	0.075	0.95
B3	0.203R		0.008R	

**Note:** All exposed metalized area shall be gold plated 60 μ-inch minimum thickness over nickel plated unless otherwise specified in purchase order.

Figure 30 · L 20-Pin Ceramic LCC Package Dimensions

**PACKAGE OUTLINE DIMENSIONS** (continued)

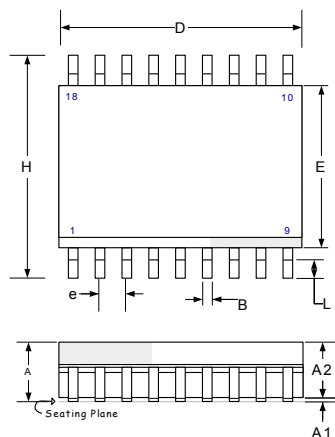

DIM	MILLIMETERS		INCHES	
	MIN	MAX	MIN	MAX
A	2.35	2.65	0.093	0.104
A1	0.10	0.30	0.004	0.012
A2	2.20	2.55	0.086	0.100
B	0.33	0.51	0.013	0.020
c	0.23	0.32	0.009	0.013
D	11.40	11.70	0.449	0.461
E	7.40	7.60	0.291	0.299
e	1.27 BSC		0.05 BSC	
H	10.00	10.65	0.394	0.419
L	0.40	1.27	0.016	0.050
θ	0°	8°	0°	8°
*LC	-	0.10	-	0.004

\* Lead Coplanarity

**Note:** Dimensions do not include mold flash or protrusions; these shall not exceed 0.155mm (0.006") on any side. Lead dimension shall not include solder coverage.

**Figure 31 · DW 18-Pin Plastic Wide-body SOIC (SOWB) Package Dimensions**

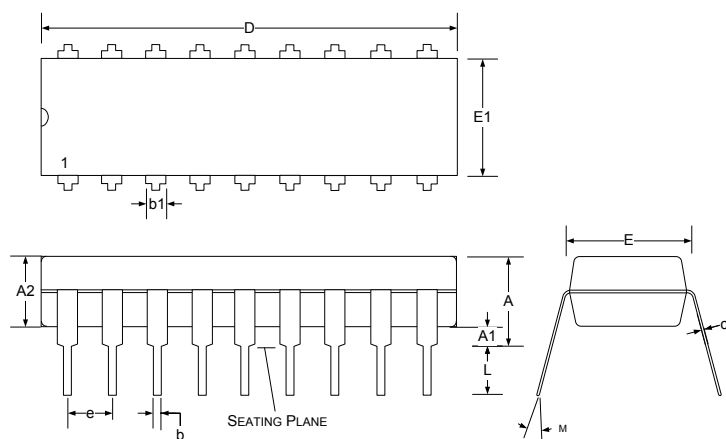

Dim	MILLIMETERS		INCHES	
	MIN	MAX	MIN	MAX
A		5.33		0.210
A1	0.38		0.015	
A2	3.30 Typ		0.130 Typ	
b	0.36	0.56	0.014	0.022
b1	1.14	1.78	0.045	0.070
c	0.20	0.36	0.008	0.014
D	22.35	23.34	0.880	0.920
e	2.54 BSC		0.100 BSC	
E	7.62	8.26	0.300	0.325
E1	6.10	7.11	0.240	0.280
L	2.92	3.81	0.115	0.150
M	-	15°	-	15°

**Note:** Dimensions do not include mold flash or protrusions; these shall not exceed 0.155mm (0.006") on any side. Lead dimension shall not include solder coverage.

**Figure 32 · N 18-Pin Plastic Dual In-line Package Dimensions**



**Microsemi**

**Microsemi Corporate Headquarters**  
One Enterprise, Aliso Viejo CA 92656 USA  
Within the USA: +1 (800) 713-4113  
Outside the USA: +1 (949) 380-6100  
Sales: +1 (949) 380-6136  
Fax: +1 (949) 215-4996  
E-mail: [sales.support@microsemi.com](mailto:sales.support@microsemi.com)

Microsemi Corporation (Nasdaq: MSCC) offers a comprehensive portfolio of semiconductor and system solutions for communications, defense and security, aerospace, and industrial markets. Products include high-performance and radiation-hardened analog mixed-signal integrated circuits, FPGAs, SoCs, and ASICs; power management products; timing and synchronization devices and precise time solutions, setting the world's standard for time; voice processing devices; RF solutions; discrete components; security technologies and scalable anti-tamper products; Power-over-Ethernet ICs and midspans; as well as custom design capabilities and services. Microsemi is headquartered in Aliso Viejo, Calif. and has approximately 3,400 employees globally. Learn more at [www.microsemi.com](http://www.microsemi.com).

© 2014 Microsemi Corporation. All rights reserved. Microsemi and the Microsemi logo are trademarks of Microsemi Corporation. All other trademarks and service marks are the property of their respective owners.

## Looking for pricing, stock, or lifecycle information?

Click below to explore more details on WIN SOURCE:

- ⊖ [View SG3526BDW on WIN SOURCE](#)
- ⊖ [Microsemi Corporation Information](#)

## Optimize Your Supply Chain with WIN SOURCE Solutions

- ✓ Global Sourcing Solution
- ✓ Obsolete Management
- ✓ Cost Control Management
- ✓ Shortage Management
- ✓ Alternative Solution
- ✓ Excess Inventory Management