



**THE DATASHEET OF
LD2985AM36R**



Very low drop and low noise voltage regulator with inhibit function

Datasheet - production data



Features

- Very low dropout voltage (280 mV at 150 mA and 7 mV at 1 mA load)
- Very low quiescent current (2 mA typ. at 150 mA load and 80 μ A at no load)
- Output current up to 150 mA
- Logic controlled electronic shutdown
- Output voltage of 1.8, 2.5, 2.8, 3, 3.1, 3.3, 5 V
- Internal current and thermal limit
- Low output noise voltage 30 mVrms
- Small package SOT23-5L
- Temperature range: - 40°C to 125 °C

Description

The LD2985 is a 150 mA fixed output voltage regulator. The ultra low drop voltage and the low quiescent current make them particularly suitable for low noise, low power applications, and in battery powered systems. In sleep mode quiescent current is less than 1 μ A when INHIBIT pin is pulled low. Shutdown logic control function is available on pin 3 (TTL compatible). This means that when the device is used as local regulator, it is possible to put a part of the board in standby, decreasing the total power consumption. An external capacitor, $C_{BYP} = 10$ nF, connected between bypass pin and GND reduces the noise to 30 μ Vrms. Typical application are in cellular phone, palmtop laptop computer, personal digital assistant (PDA), personal stereo, camcorder and camera.

Table 1. Device summary

Order codes	Output voltages
LD2985BM18R	1.8 V
LD2985BM25R	2.5 V
LD2985BM28R	2.8 V
LD2985BM30R	3.0 V
LD2985BM31R	3.1 V
LD2985BM33R	3.3 V
LD2985BM50R	5.0 V

Contents

1	Diagram	3
2	Pin configuration	4
3	Maximum ratings	5
4	Electrical characteristics	6
5	Typical characteristics	8
6	Application notes	11
6.1	External capacitors	11
6.2	Input capacitor	11
6.3	Output capacitor	11
6.4	Important	11
6.5	Inhibit input operation	11
6.6	Reverse current	12
7	Package mechanical data	13
8	Packaging mechanical data	15
9	Revision history	16

1 Diagram

Figure 1. Schematic diagram

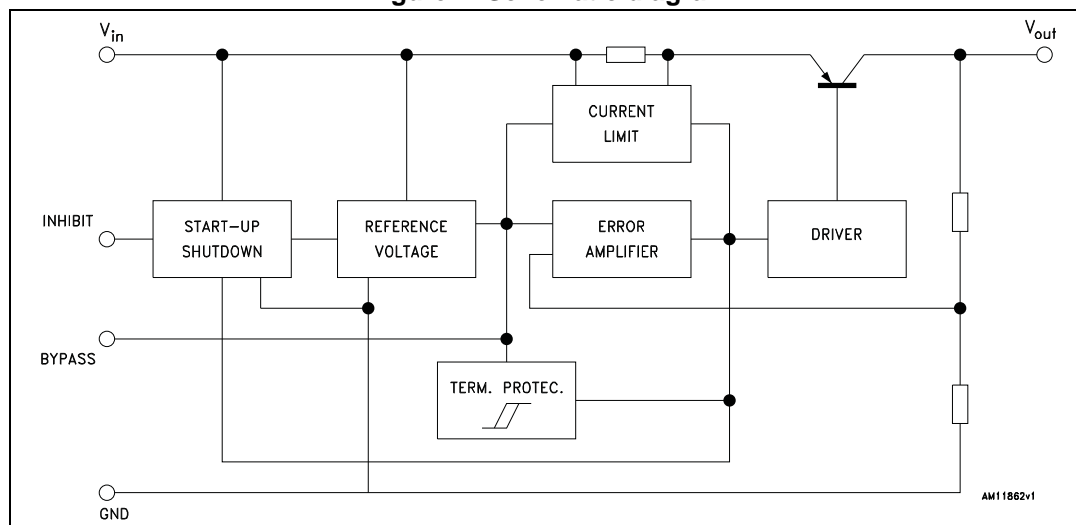

2 Pin configuration

Figure 2. Pin connections (top view)

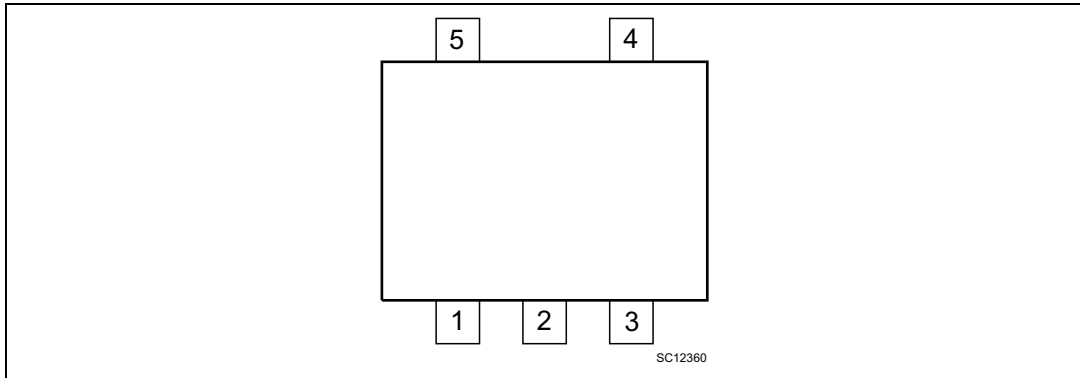

Table 2. Pin description

Pin n°	Symbol	Name and function
1	IN	Input port
2	GND	Ground pin
3	INHIBIT	Control switch ON/OFF. Inhibit is not internally pulled-up; it cannot be left floating. Disable the device when connected to GND or to a positive voltage less than 0.18 V
4	Bypass	Bypass pin: capacitor to be connected to GND in order to improve the thermal noise performances
5	OUT	Output port

Table 3. Thermal data

Symbol	Parameter	Value	Unit
R_{thJC}	Thermal resistance junction-case	81	°C/W
R_{thJA}	Thermal resistance junction-ambient	255	°C/W

3 Maximum ratings

Table 4. Absolute maximum ratings

Symbol	Parameter	Value	Unit
V_I	DC input voltage	-0.3 to 16	V
V_{INH}	INHIBIT input voltage	-0.3 to 16	V
I_O	Output current	Internally limited	
P_D	Power dissipation	Internally limited	
T_{STG}	Storage temperature range	-65 to 150	°C
T_{OP}	Operating junction temperature range	-40 to 125	°C

Note: Absolute maximum ratings are those values beyond which damage to the device may occur. Functional operation under these condition is not implied.

4 Electrical characteristics

$T_J = 25\text{ °C}$, $V_I = V_O + 1\text{ V}$, $I_O = 50\text{ mA}$, $V_{INH} = 2\text{ V}$, $C_I = C_O = 1\text{ }\mu\text{F}$, unless otherwise specified.

Table 5. Electrical characteristics

Symbol	Parameter	Test conditions	Min.	Typ.	Max.	Unit
V_{OP}	Operating input voltage		2.5		16	V
V_O	Output voltage	$V_I = 2.8\text{ V}$	1.755	1.8	1.845	V
		$I_O = 1\text{ to }150\text{ mA}$	1.746		1.854	
		$I_O = 1\text{ to }150\text{ mA}$, $T_J = -40\text{ to }125\text{ °C}$	1.728		1.872	
V_O	Output voltage	$V_I = 3.5\text{ V}$	2.437	2.5	2.562	V
		$I_O = 1\text{ to }150\text{ mA}$	2.425		2.575	
		$I_O = 1\text{ to }150\text{ mA}$, $T_J = -40\text{ to }125\text{ °C}$	2.4		2.6	
V_O	Output voltage	$V_I = 3.8\text{ V}$	2.73	2.8	2.87	V
		$I_O = 1\text{ to }150\text{ mA}$	2.716		2.884	
		$I_O = 1\text{ to }150\text{ mA}$, $T_J = -40\text{ to }125\text{ °C}$	2.688		2.912	
V_O	Output voltage	$V_I = 4.0\text{ V}$	2.925	3.0	3.075	V
		$I_O = 1\text{ to }150\text{ mA}$	2.91		3.09	
		$I_O = 1\text{ to }150\text{ mA}$, $T_J = -40\text{ to }125\text{ °C}$	2.88		3.12	
V_O	Output voltage	$V_I = 4.1\text{ V}$	3.023	3.1	3.177	V
		$I_O = 1\text{ to }150\text{ mA}$	3.007		3.193	
		$I_O = 1\text{ to }150\text{ mA}$, $T_J = -40\text{ to }125\text{ °C}$	2.976		3.224	
V_O	Output voltage	$V_I = 4.3\text{ V}$	3.218	3.3	3.382	V
		$I_O = 1\text{ to }150\text{ mA}$	3.201		3.399	
		$I_O = 1\text{ to }150\text{ mA}$, $T_J = -40\text{ to }125\text{ °C}$	3.168		3.432	
V_O	Output voltage	$V_I = 6.0\text{ V}$	4.875	5	5.125	V
		$I_O = 1\text{ to }150\text{ mA}$	4.85		5.15	
		$I_O = 1\text{ to }150\text{ mA}$, $T_J = -40\text{ to }125\text{ °C}$	4.8		5.2	
I_{SC}	Short circuit current	$R_L = 0$		400		mA
$\Delta V_O/\Delta V_I$	Line regulation	$V_I = V_O + 1\text{ V to }16\text{ V}$, $I_O = 1\text{ mA}$		0.003	0.014	%/ V_I
		$V_I = V_O + 1\text{ V to }16\text{ V}$, $I_O = 1\text{ mA}$, $T_J = -40\text{ to }125\text{ °C}$			0.032	

Table 5. Electrical characteristics (continued)

Symbol	Parameter	Test conditions	Min.	Typ.	Max.	Unit
V_{DROP}	Dropout voltage	$I_{\text{O}} = 0$		1	3	mV
		$I_{\text{O}} = 0, T_{\text{J}} = -40 \text{ to } 125 \text{ }^{\circ}\text{C}$			5	
		$I_{\text{O}} = 1 \text{ mA}$		7	10	
		$I_{\text{O}} = 1 \text{ mA}, T_{\text{J}} = -40 \text{ to } 125 \text{ }^{\circ}\text{C}$			15	
		$I_{\text{O}} = 10 \text{ mA}$		40	60	
		$I_{\text{O}} = 10 \text{ mA}, T_{\text{J}} = -40 \text{ to } 125 \text{ }^{\circ}\text{C}$			90	
		$I_{\text{O}} = 50 \text{ mA}$		120	150	
		$I_{\text{O}} = 50 \text{ mA}, T_{\text{J}} = -40 \text{ to } 125 \text{ }^{\circ}\text{C}$			225	
		$I_{\text{O}} = 150 \text{ mA}$		280	350	
		$I_{\text{O}} = 150 \text{ mA}, T_{\text{J}} = -40 \text{ to } 125 \text{ }^{\circ}\text{C}$			575	
I_{Q}	Quiescent current ON MODE	$I_{\text{O}} = 0$		80	100	μA
		$I_{\text{O}} = 0, T_{\text{J}} = -40 \text{ to } 125 \text{ }^{\circ}\text{C}$			150	
		$I_{\text{O}} = 1 \text{ mA}$		100	150	
		$I_{\text{O}} = 1 \text{ mA}, T_{\text{J}} = -40 \text{ to } 125 \text{ }^{\circ}\text{C}$			200	
		$I_{\text{O}} = 10 \text{ mA}$		200	300	
		$I_{\text{O}} = 10 \text{ mA}, T_{\text{J}} = -40 \text{ to } 125 \text{ }^{\circ}\text{C}$			400	
		$I_{\text{O}} = 50 \text{ mA}$		600	900	
		$I_{\text{O}} = 50 \text{ mA}, T_{\text{J}} = -40 \text{ to } 125 \text{ }^{\circ}\text{C}$			1200	
		$I_{\text{O}} = 150 \text{ mA}$		2000	3000	
		$I_{\text{O}} = 150 \text{ mA}, T_{\text{J}} = -40 \text{ to } 125 \text{ }^{\circ}\text{C}$			4000	
	OFF MODE	$V_{\text{INH}} < 0.18 \text{ V}$		0		
		$V_{\text{INH}} < 0.18 \text{ V}, T_{\text{J}} = -40 \text{ to } 125 \text{ }^{\circ}\text{C}$			2	
SVR	Supply voltage rejection	$C_{\text{BYP}} = 0.01 \text{ } \mu\text{F}, C_{\text{O}} = 10 \text{ } \mu\text{F}, f = 1 \text{ kHz}$		45		dB
V_{IL}	Inhibit input logic low	$T_{\text{J}} = -40 \text{ to } 125 \text{ }^{\circ}\text{C}$			0.15	V
V_{IH}	Inhibit input logic high	$T_{\text{J}} = -40 \text{ to } 125 \text{ }^{\circ}\text{C}$	2			V
I_{INH}	Inhibit input current	$V_{\text{INH}} = 0 \text{ V}, T_{\text{J}} = -40 \text{ to } 125 \text{ }^{\circ}\text{C}$		5	15	μA
		$V_{\text{INH}} = 5 \text{ V}, T_{\text{J}} = -40 \text{ to } 125 \text{ }^{\circ}\text{C}$		0	-1	
e_{N}	Output noise voltage	$B = 300 \text{ Hz to } 50 \text{ kHz}, C_{\text{BYP}} = 0.01 \text{ } \mu\text{F}, C_{\text{O}} = 10 \text{ } \mu\text{F}$		30		μV

5 Typical characteristics

$T_J = 25\text{ }^\circ\text{C}$, $V_I = V_{O(NOM)} + 1\text{ V}$, $C_I = 1\text{ }\mu\text{F(X7R)}$, $C_O = 2.2\text{ }\mu\text{F(X7R)}$, $V_{INH} = 2\text{ V}$, unless otherwise specified.

Figure 3. Output voltage vs. temperature ($V_O = 2.5\text{ V}$)

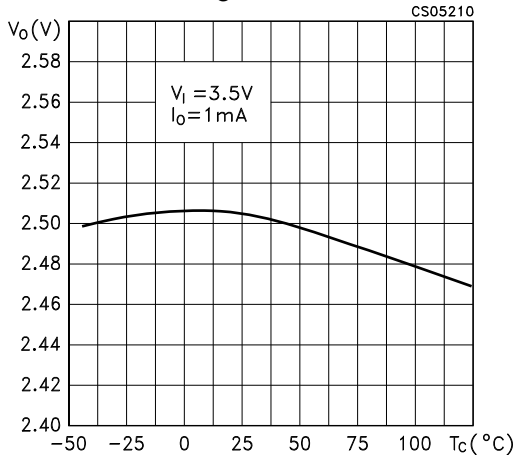

Figure 4. Dropout voltage vs. temperature ($V_O = 2.5\text{ V}$)

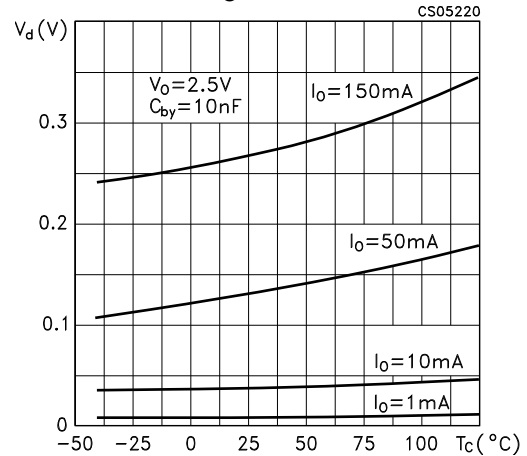

Figure 5. Dropout voltage vs. output current

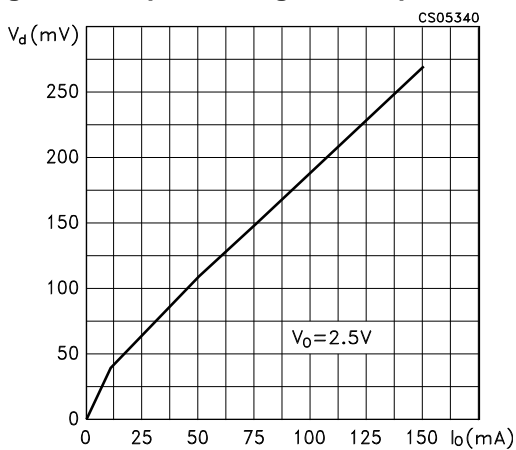

Figure 6. Quiescent current vs. load current

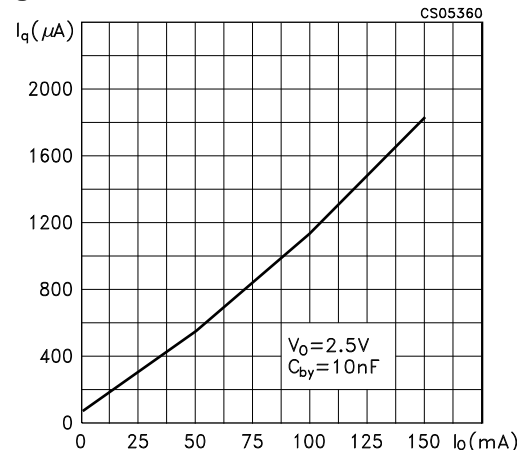

Figure 7. Quiescent current vs. temperature

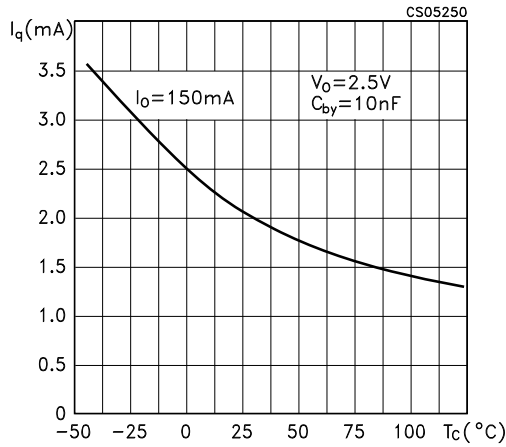

Figure 8. Supply voltage rejection vs. temp.

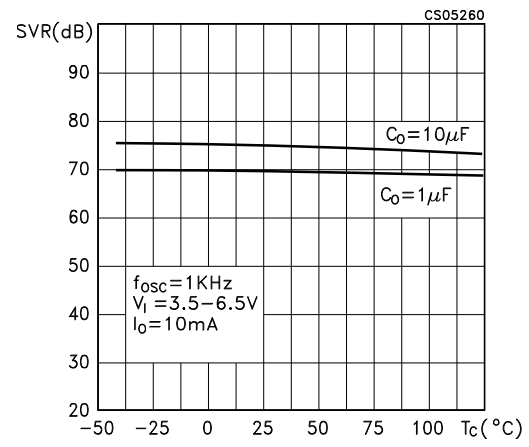

Figure 9. Supply voltage rejection vs. output current ($C_o = 10 \mu\text{F}$)

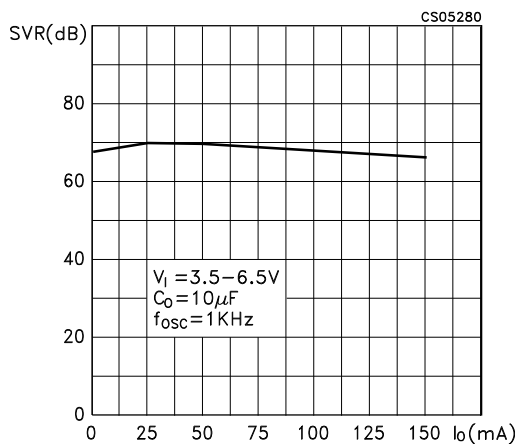

Figure 10. Supply voltage rejection vs. output current ($C_o = 1 \mu\text{F}$)

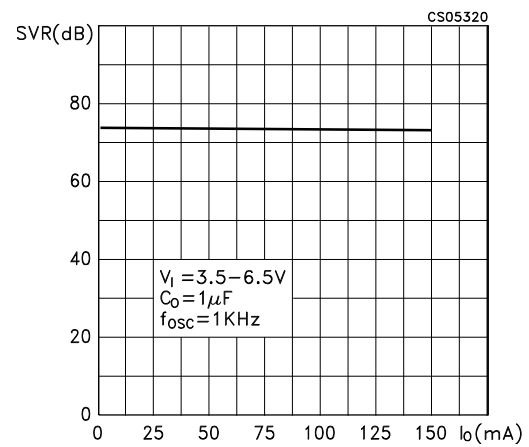

Figure 11. Supply voltage rejection vs. frequency ($C_o = 10 \mu\text{F}$)

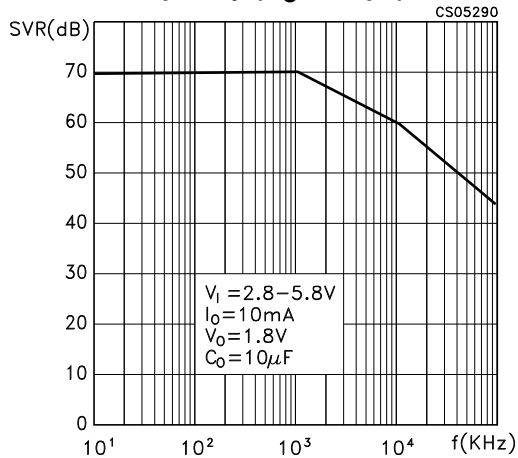

Figure 12. Supply voltage rejection vs. frequency ($C_o = 1 \mu\text{F}$)

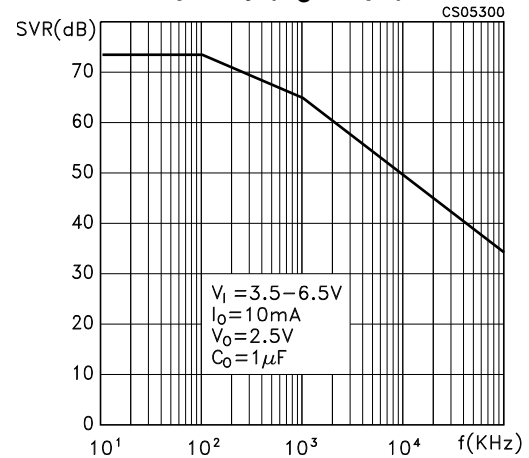
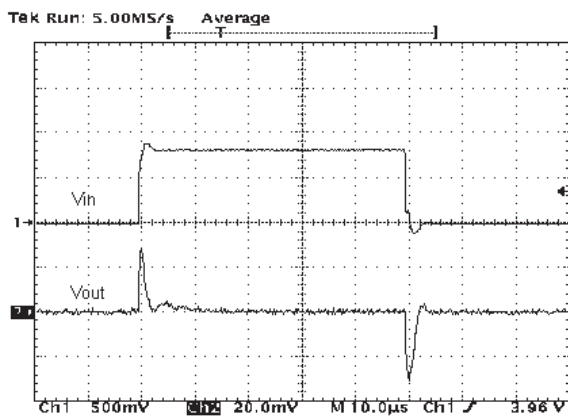
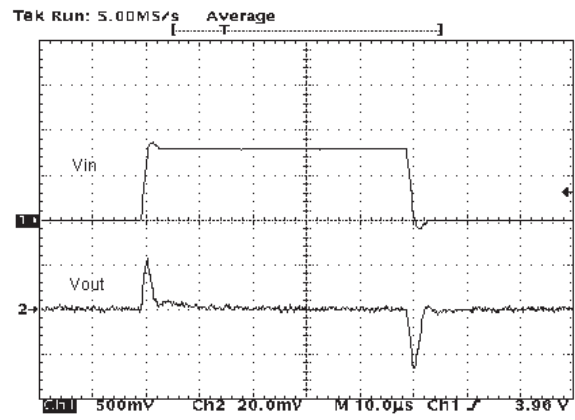

Figure 13. Line transient ($t_r = t_f = 500$ ns)



$V_O = 2.5$ V, $I_O = 50$ mA, no C_I , $C_O = 4.7$ μ F, $t_r = t_f = 500$ ns

Figure 14. Line transient ($t_r = t_f = 1$ μ s)



$V_O = 2.5$ V, $I_O = 50$ mA, no C_I , $C_O = 4.7$ μ F, $t_r = t_f = 1$ μ s

Figure 15. Load transient ($C_O = 10$ μ F)

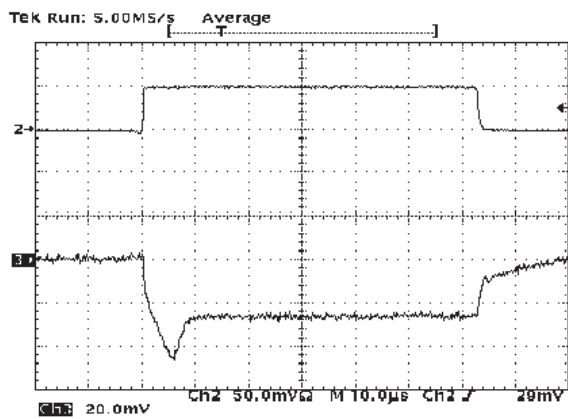

$V_O = 2.5$ V, $I_O = 0$ to 50 mA, no C_I , $C_O = 10$ μ F, $t_r = t_f = 500$ ns

Figure 16. Load transient ($C_O = 4.7$ μ F)

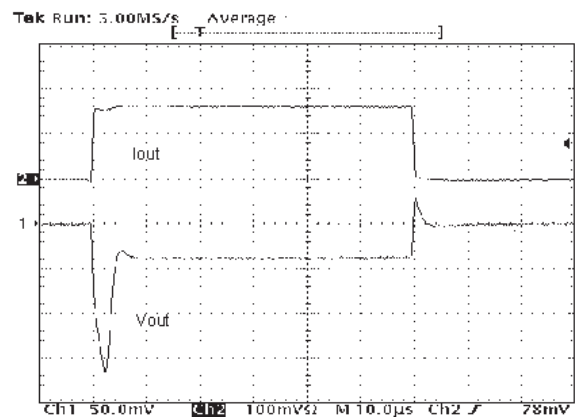

$V_O = 2.5$ V, $I_O = 0$ to 50 mA, no C_I , $C_O = 4.7$ μ F, $t_r = t_f = 500$ ns

6 Application notes

6.1 External capacitors

Like any low-dropout regulator, the LD2985 requires external capacitors for regulator stability. This capacitor must be selected to meet the requirements of minimum capacitance and equivalent series resistance. We suggest to solder input and output capacitors as close as possible to the relative pins.

6.2 Input capacitor

An input capacitor whose value is 1 μF is required with the LD2985 (amount of capacitance can be increased without limit). This capacitor must be located a distance of not more than 0.5" from the input pin of the device and returned to a clean analog ground. Any good quality ceramic, tantalum or film capacitors can be used for this capacitor.

6.3 Output capacitor

The LD2985 is designed specifically to work with ceramic output capacitors. It may also be possible to use Tantalum capacitors, but these are not as attractive for reasons of size and cost. By the way, the output capacitor must meet both the requirement for minimum amount of capacitance and ESR (equivalent series resistance) value. Due to the different loop gain, the stability improves for higher output versions and so the suggested minimum output capacitor value, if low ESR ceramic type is used, is 1 μF for output voltages equal or major than 3.8 V, 2.2 μF for V_{O} going from 1.8 to 3.3 V, and 3.3 μF for the other versions. However, if an output capacitor lower than the suggested one is used, it's possible to make stable the regulator adding a resistor in series to the capacitor.

6.4 Important

The output capacitor must maintain its ESR in the stable region over the full operating temperature to assure stability. Also, capacitor tolerance and variation with temperature must be considered to assure the minimum amount of capacitance is provided at all times. This capacitor should be located not more than 0.5" from the output pin of the device and returned to a clean analog ground.

6.5 Inhibit input operation

The inhibit pin can be used to turn OFF the regulator when pulled low, so drastically reducing the current consumption down to less than 1 μA . When the inhibit feature is not used, this pin must be tied to V_{I} to keep the regulator output ON at all times. To assure proper operation, the signal source used to drive the inhibit pin must be able to swing above and below the specified thresholds listed in the electrical characteristics section under V_{IH} V_{IL} . Any slew rate can be used to drive the inhibit.

6.6 Reverse current

The power transistor used in the LD2985 has not an inherent diode connected between the regulator input and output. If the output is forced above the input, no current will flow from the output to the input across the series pass transistor. When a V_{REV} voltage is applied on the output, the reverse current measured flows to the GND across the two feedback resistors. This current typical value is $160 \mu A$. R_1 and R_2 resistors are implanted type; typical values are, respectively, $42.6 k\Omega$ and $51.150 k\Omega$.

Figure 17. Reverse current test circuit

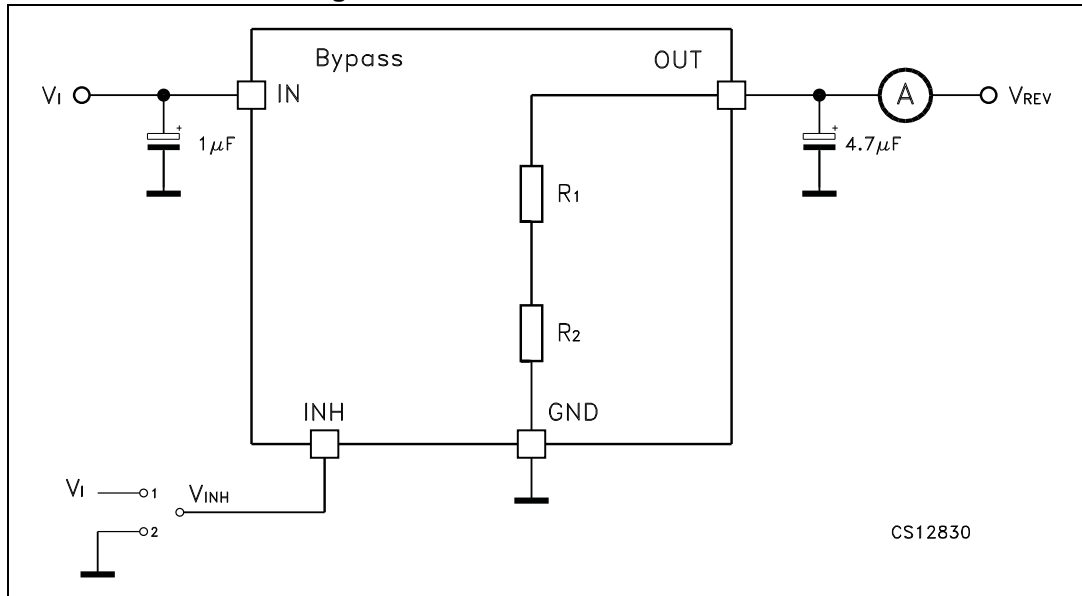

CS12830

7 Package mechanical data

In order to meet environmental requirements, ST offers these devices in different grades of ECOPACK® packages, depending on their level of environmental compliance. ECOPACK® specifications, grade definitions and product status are available at: www.st.com. ECOPACK® is an ST trademark.

Table 6. SOT23-5L mechanical data

Dim.	mm		
	Min.	Typ.	Max.
A	0.90		1.45
A1	0		0.15
A2	0.90		1.30
b	0.30		0.50
c	2.09		0.20
D		2.95	
E		1.60	
e		0.95	
H		2.80	
L	0.30		0.60
θ	0		8

Figure 18. SOT23-5L mechanical drawing

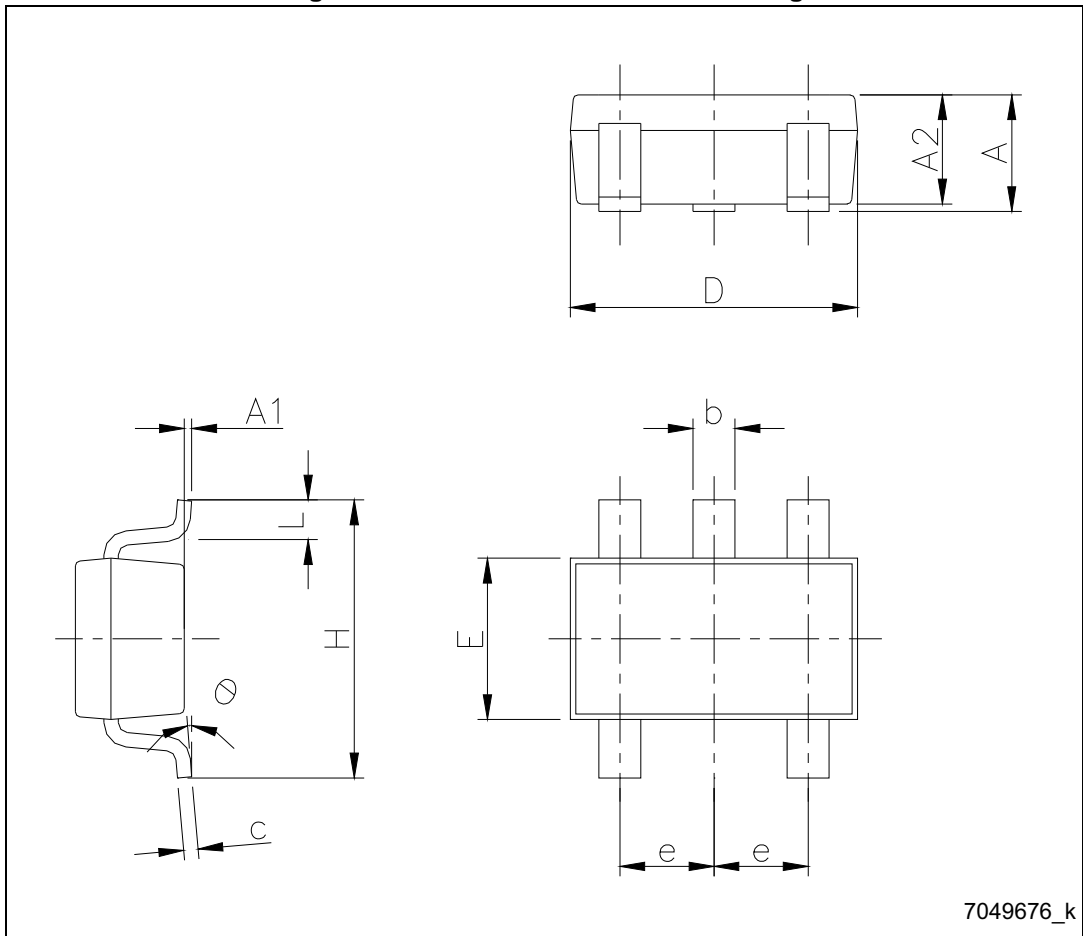

7049676_k

Figure 19. SOT23-5L recommended footprint (dimensions in mm)

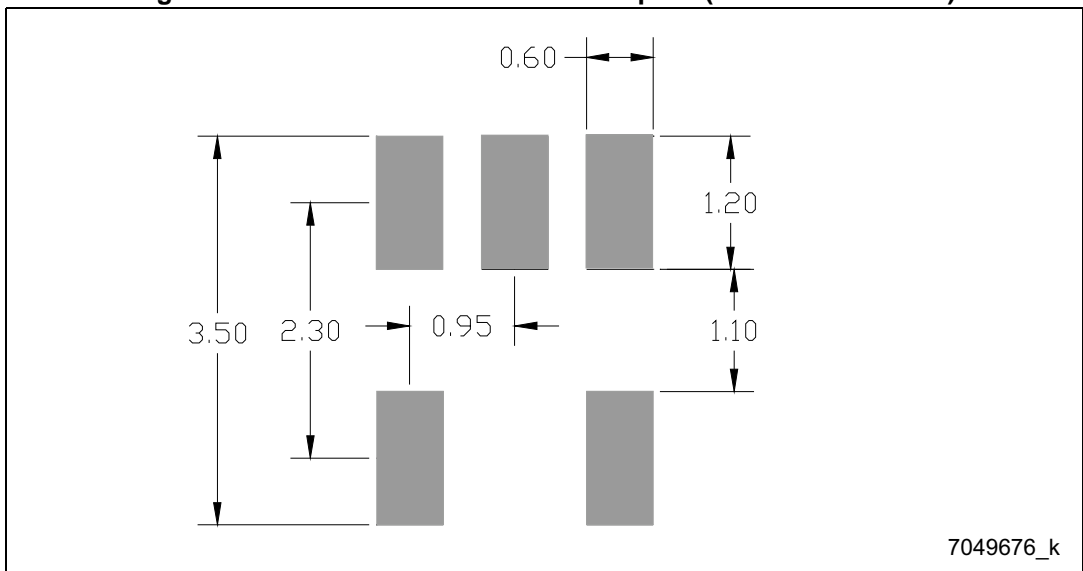

7049676_k

8 Packaging mechanical data

Table 7. Tape and reel SOT23-5L mechanical data

Dim.	mm		
	Min.	Typ.	Max.
A			180
C	12.8	13.0	13.2
D	20.2		
N	60		
T			14.4
Ao	3.13	3.23	3.33
Bo	3.07	3.17	3.27
Ko	1.27	1.37	1.47
Po	3.9	4.0	4.1
P	3.9	4.0	4.1

Figure 20. Tape and reel SOT23-5L mechanical drawing

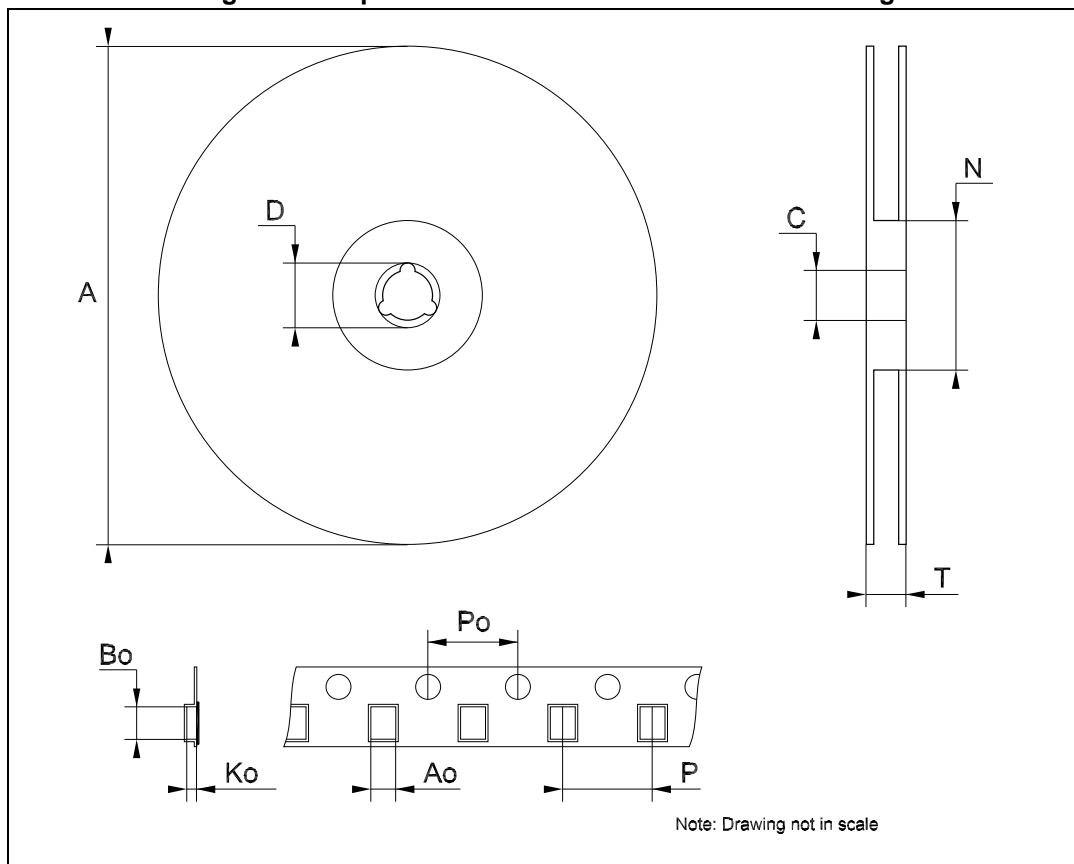

9 Revision history

Table 8. Document revision history

Date	Revision	Changes
22-Aug-2005	4	Add new value $V_O \Rightarrow 2.7$ V on tables 5 and 6.
02-Sep-2005	5	Mistake V_O min. $\Rightarrow 2.7$ V on table 5.
25-Jul-2006	6	Order codes updated.
13-Feb-2008	7	Added: Table 1 on page 1.
04-Mar-2008	8	Modified: Table 5 on page 6.
10-Jul-2008	9	Modified: Table 1 on page 1 and Table 5 on page 6.
27-Aug-2008	10	Modified: Features on page 1.
27-Jan-2009	11	Modified: Features on page 1.
09-Feb-2012	12	Modified: pin inhibit Figure 1 on page 3. Removed: order codes and electrical characteristics table for type A.
12-Nov-2013	13	RPN LD2985Bxx changed to LD2985. Updated the Title and the Description in cover page. Modified Table 1: Device summary, the title of the Figure 3: Output voltage vs. temperature ($V_O = 2.5$ V) and Section 7: Package mechanical data Added Section 8: Packaging mechanical data Minor text changes
08-Feb-2019	14	Updated: V_I , V_{INH} value in Table 4: Absolute maximum ratings and Table 5: Electrical characteristics

IMPORTANT NOTICE – PLEASE READ CAREFULLY

STMicroelectronics NV and its subsidiaries ("ST") reserve the right to make changes, corrections, enhancements, modifications, and improvements to ST products and/or to this document at any time without notice. Purchasers should obtain the latest relevant information on ST products before placing orders. ST products are sold pursuant to ST's terms and conditions of sale in place at the time of order acknowledgement.

Purchasers are solely responsible for the choice, selection, and use of ST products and ST assumes no liability for application assistance or the design of Purchasers' products.

No license, express or implied, to any intellectual property right is granted by ST herein.

Resale of ST products with provisions different from the information set forth herein shall void any warranty granted by ST for such product.



ST and the ST logo are trademarks of ST. All other product or service names are the property of their respective owners.

Information in this document supersedes and replaces information previously supplied in any prior versions of this document.

© 2019 STMicroelectronics – All rights reserved

Looking for pricing, stock, or lifecycle information?

Click below to explore more details on WIN SOURCE:

-  [View LD2985AM36R](#) on WIN SOURCE
-  [STMicroelectronics](#) Information

Optimize Your Supply Chain with WIN SOURCE Solutions

-  Global Sourcing Solution
-  Obsolete Management
-  Cost Control Management
-  Shortage Management
-  Alternative Solution
-  Excess Inventory Management