



**THE DATASHEET OF  
AUR9705AGH**



## Description

The AUR9705 is a high efficiency step-down DC-DC voltage converter. The chip operation is optimized using constant frequency, peak-current mode architecture with built-in synchronous power MOSFET switchers and internal compensators to reduce external part counts. It is automatically switching between the normal PWM mode and LDO mode to offer improved system power efficiency covering a wide range of loading conditions.

The oscillator and timing capacitors are all built-in providing an internal switching frequency of 1.5MHz that allows the use of small surface mount inductors and capacitors for portable product implementations. Additional features included Soft Start (SS), Under Voltage Lock Out (UVLO) and Thermal Shutdown Detection (TSD) to provide reliable product applications.

The device is available in adjustable output voltage versions ranging from 1V to 3.3V, and is able to deliver up to 1A.

The AUR9705 is available in WDFN-2x2-6 and TSOT-23-5 packages.

## Features

- High Efficiency Buck Power Converter
- Low Quiescent Current
- Output Current: 1A
- Adjustable Output Voltage from 1V to 3.3V
- Wide Operating Voltage Range: 2.5V to 5.5V
- Built-In Power Switches for Synchronous Rectification with High Efficiency
- Feedback Voltage: 600mV
- 1.5MHz Constant Frequency Operation
- Automatic PWM/LDO Mode Switching Control
- Thermal Shutdown Protection
- Low Drop-Out Operation at 100% Duty Cycle
- No Schottky Diode Required

## Pin Assignments

(Top View)

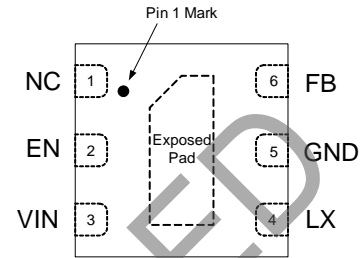

**WDFN-2x2-6**

(Top View)

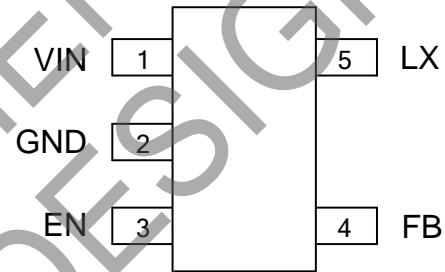

**TSOT-23-5**

## Applications

- Mobile Phone, Digital Camera and MP3 Player
- Headset, Radio and Other Hand-held Instrument
- Post DC-DC Voltage Regulation
- PDA and Notebook Computer

**Typical Applications Circuit**

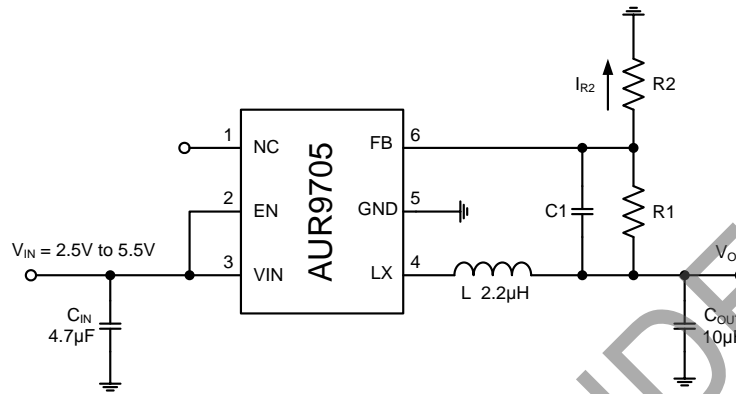

For WDFN-2x2-6

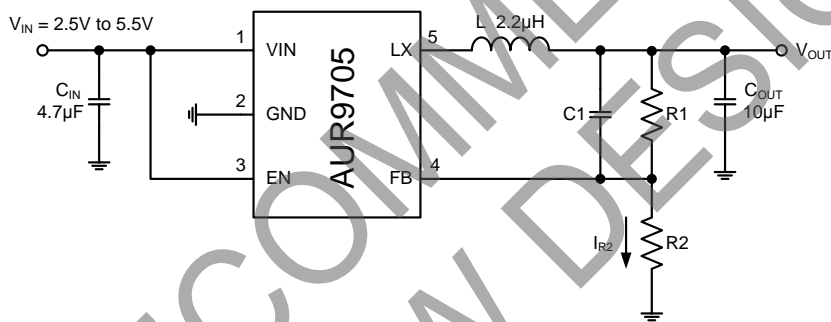

For TSOT-23-5

Note 1:  $V_{OUT} = V_{FB} \times (1 + \frac{R_1}{R_2})$

When  $R_2=300k\Omega$  to  $60k\Omega$ , the  $I_{R2}=2\mu A$  to  $10\mu A$ , and  $R_1 \times C_1$  should be in the range between  $3 \times 10^{-6}$  and  $6 \times 10^{-6}$  for component selection.

V <sub>OUT</sub> (V)	R <sub>1</sub> (kΩ)	R <sub>2</sub> (kΩ)	C <sub>1</sub> (pF)	L <sub>1</sub> (µH)
3.3	453	100	13	2.2
2.5	320	100	18	2.2
1.8	200	100	30	2.2
1.2	100	100	56	2.2
1.0	68	100	82	2.2

Table 1. Component Guide

**Pin Descriptions**

Pin Number		Pin Name	Function
WDFN-2x2-6	TSOT-23-5		
1	—	NC	No internal connection (Floating or connected to GND)
2	3	EN	Enable signal input, active high
3	1	VIN	Power supply input
4	5	LX	Connect to inductor
5	2	GND	This pin is the GND reference for the NMOS power stage. It must be connected to the system ground
6	4	FB	Feedback voltage from the output of the power supply

**Functional Block Diagram**

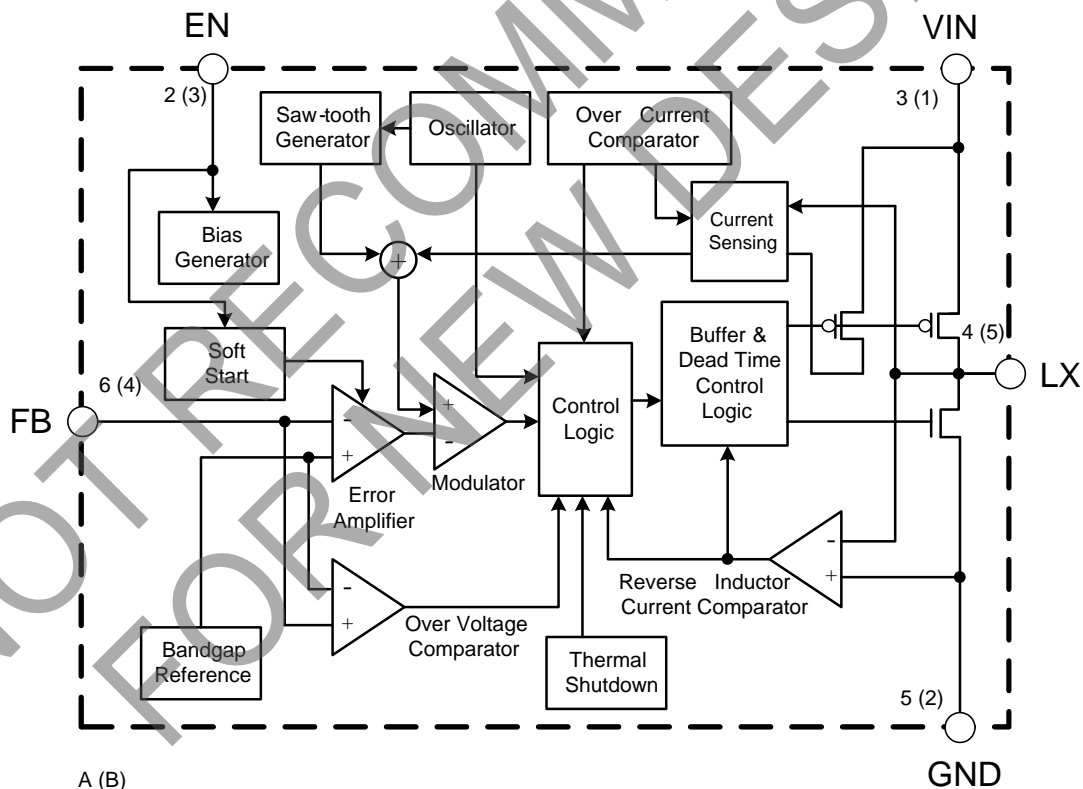

A (B)  
A for WDFN-2x2-6  
B for TSOT-23-5

## Absolute Maximum Ratings (Note 2)

Symbol	Parameter	Value	Unit
$V_{IN}$	Supply Input Voltage	0 to 6.0	V
$V_{EN}$	Enable Input Voltage	-0.3 to $V_{IN}+0.3$	V
$V_{LX}$	Switch Output Voltage (Note 3)	-0.3 to $V_{IN}+0.3$	V
$P_D$	Power Dissipation (On PCB, $T_A=+25^{\circ}C$ )	1.89	W
$\theta_{JA}$	Thermal Resistance (Junction to Ambient, Simulation)	53	$^{\circ}C/W$
$\theta_{JC}$	Thermal Resistance (Junction to Case, Simulation)	0.85	$^{\circ}C/W$
$T_J$	Operating Junction Temperature	+160	$^{\circ}C$
$T_{OP}$	Operating Temperature	-40 to +85	$^{\circ}C$
$T_{STG}$	Storage Temperature	-55 to +150	$^{\circ}C$
$V_{HBM}$	ESD (Human Body Model)	2000	V
$V_{MM}$	ESD (Machine Model)	200	V

Note 2: Stresses greater than those listed under "Absolute Maximum Ratings" can cause permanent damage to the device. These are stress ratings only, and functional operation of the device at these or any other conditions beyond those indicated under "Recommended Operating Conditions" is not implied. Exposure to "Absolute Maximum Ratings" for extended periods can affect device reliability.

3: If the switching spike duration is less than 100ns, the absolute maximum range of  $V_{LX}$  should be -4.5V to 7.5V.

## Recommended Operating Conditions

Symbol	Parameter	Min	Max	Unit
$V_{IN}$	Supply Input Voltage	2.5	5.5	V
$T_J$	Junction Temperature Range	-20	+125	$^{\circ}C$
$T_A$	Ambient Temperature Range	-40	+80	$^{\circ}C$

**Electrical Characteristics** ( $V_{IN}=V_{EN}=5V$ ,  $V_{FB}=0.6V$ ,  $L=2.2\mu H$ ,  $C_{IN}=4.7\mu F$ ,  $C_{OUT}=10\mu F$ ,  $T_A=+25^\circ C$ , unless otherwise specified.)

Symbol	Parameter	Conditions	Min	Typ	Max	Unit
$V_{IN}$	Input Voltage Range	—	2.5	—	5.5	V
$I_{OFF}$	Shutdown Current	$V_{EN}=0V$	—	0.1	1	$\mu A$
$V_{FB}$	Regulated Feedback Voltage	For Adjustable Output Voltage	0.585	0.6	0.615	V
$\Delta V_{OUT}/V_{OUT}$	Regulated Output Voltage Accuracy	$V_{IN}=2.5V$ to $5.5V$ , $I_{OUT}=0$ to $1A$	-3	—	3	%
$I_{PK}$	Peak Inductor Current	$V_{FB}=0.5V$	—	1.5	—	A
$f_{OSC}$	Oscillator Frequency	—	1.2	1.5	1.8	MHz
$R_{ON(P)}$	PMOSFET $R_{ON}$	$I_{OUT}=200mA$	—	0.25	—	$\Omega$
$R_{ON(N)}$	NMOSFET $R_{ON}$	$I_{OUT}=200mA$	—	0.27	—	$\Omega$
$I_Q$	Quiescent Current	$I_{OUT}=0A$ , $V_{FB}=0.7V$	—	100	—	$\mu A$
$I_{LX}$	LX Leakage Current	$V_{EN}=0V$ , $V_{LX}=0V$ or $5V$	—	0.01	0.1	$\mu A$
$I_{FB}$	Feedback Current	—	—	—	30	nA
$I_{EN}$	EN Leakage Current	—	—	0.01	0.1	$\mu A$
$V_{EN\_H}$	EN High-Level Input Voltage	$V_{IN}=2.5V$ to $5.5V$	1.5	—	—	V
$V_{EN\_L}$	EN Low-Level Input Voltage	$V_{IN}=2.5V$ to $5.5V$	—	—	0.6	V
$V_{UVLO}$	Under Voltage Lock Out	Rising	—	1.8	—	V
—	Hysteresis	—	—	0.1	—	V
$T_{SD}$	Thermal Shutdown	—	—	+160	—	$^\circ C$

NOT RECOMMENDED FOR NEW DESIGN

**Performance Characteristics**

**Efficiency vs. Output Current ( $V_{OUT}=1.2V$ )**

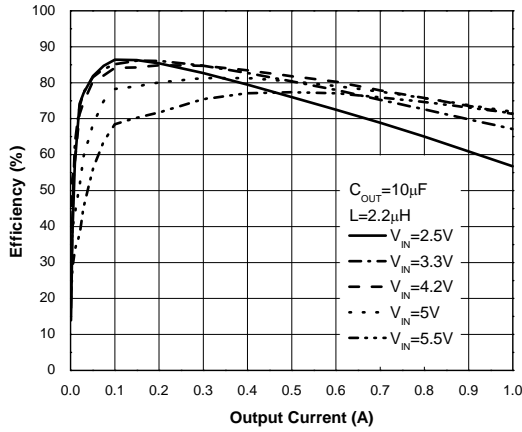

**Efficiency vs. Output Current ( $V_{OUT}=2.5V$ )**

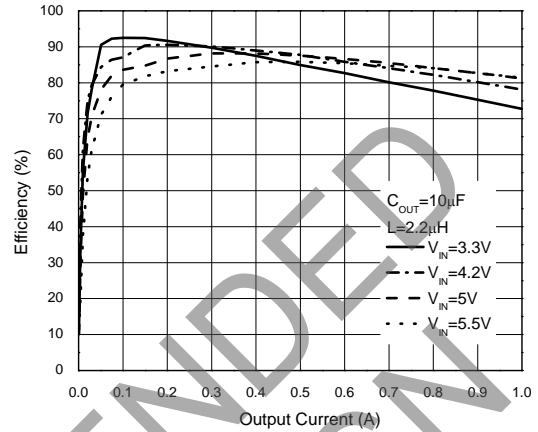

**Efficiency vs. Output Current ( $V_{OUT}=3.3V$ )**

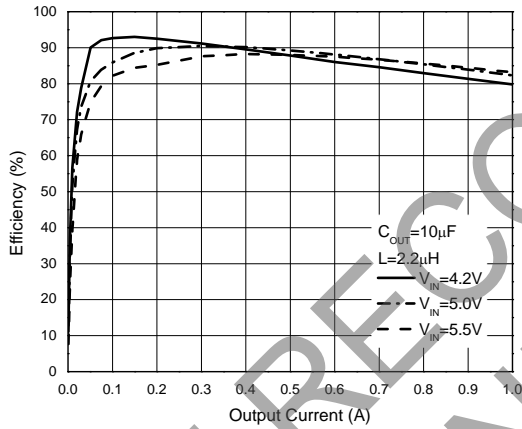

**Frequency vs. Input Voltage**

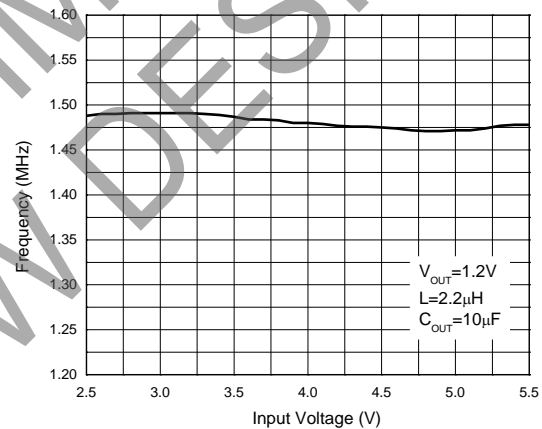

**Output Voltage vs. Output Current ( $V_{OUT}=1.2\pm 0.03V$ )**

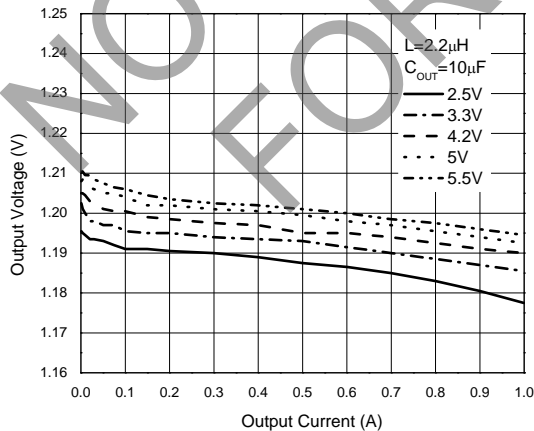

**Output Ripple ( $V_{IN}=5.0V, V_{OUT}=3.3V, I_{OUT}=1A$ )**

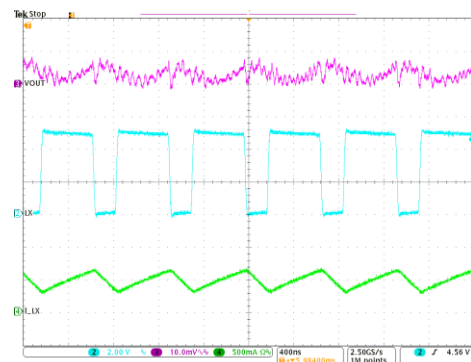

**Performance Characteristics** (continued)

**Power Off through VIN**  
( $V_{IN}=V_{EN}=5.0$  to  $0V$ ,  $V_{OUT}=3.3V$ ,  $I_{OUT}=1A$ )

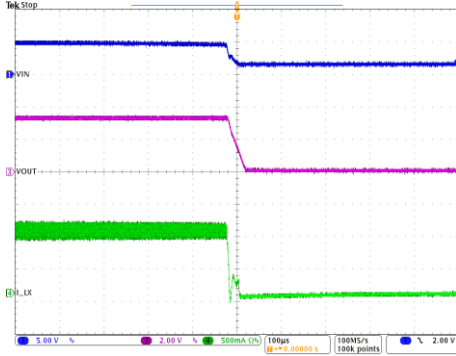

**Soft Start (Power Up through EN)**  
( $V_{IN}=5.0V$ ,  $V_{OUT}=3.3V$ ,  $I_{OUT}=1A$ ,  $V_{EN}=0$  to  $5.0V$ )

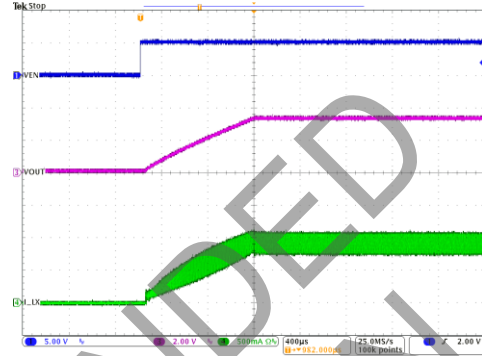

**Load Transient**  
( $V_{IN}=5.0V$ ,  $V_{OUT}=1.2V$ ,  $I_{OUT}=0.1$  to  $1A$ )

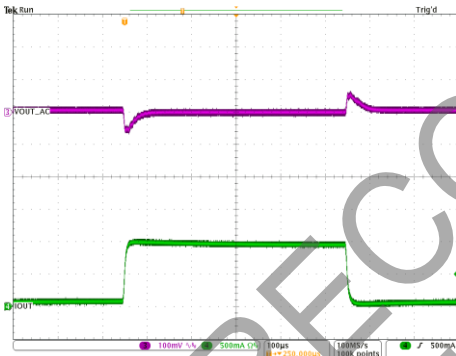

**Load Transient**  
( $V_{IN}=5.0V$ ,  $V_{OUT}=3.3V$ ,  $I_{OUT}=0.1$  to  $1A$ )

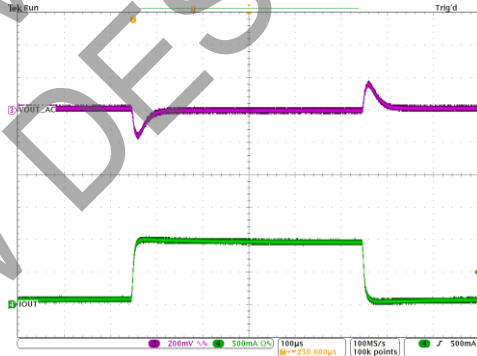

**Short Circuit**  
( $V_{IN}=5.0V$ ,  $V_{OUT}=3.3V$  Short to GND,  $I_{OUT}=1A$ )

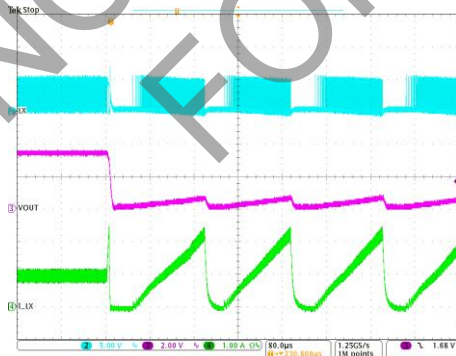

## Application Information

The basic AUR9705 application circuit is shown in Typical Applications Circuit, external components selection is determined by the load current and is critical with the selection of inductor and capacitor values.

### 1. Inductor Selection

For most applications, the value of inductor is chosen based on the required ripple current with the range of 2.2μH to 4.7μH.

$$\Delta I_L = \frac{1}{f \times L} V_{OUT} \left(1 - \frac{V_{OUT}}{V_{IN}}\right)$$

The largest ripple current occurs at the highest input voltage. Having a small ripple current reduces the ESR loss in the output capacitor and improves the efficiency. The highest efficiency is realized at low operating frequency with small ripple current. However, larger value inductors will be required. A reasonable starting point for ripple current setting is  $\Delta I_L = 40\% I_{MAX}$ . For a maximum ripple current stays below a specified value, the inductor should be chosen according to the following equation:

$$L = \left[ \frac{V_{OUT}}{f \times \Delta I_L (MAX)} \right] \left[ 1 - \frac{V_{OUT}}{V_{IN} (MAX)} \right]$$

The DC current rating of the inductor should be at least equal to the maximum output current plus half the highest ripple current to prevent inductor core saturation. For better efficiency, a lower DC-resistance inductor should be selected.

### 2. Capacitor Selection

The input capacitance,  $C_{IN}$ , is needed to filter the trapezoidal current at the source of the top MOSFET. To prevent large ripple voltage, a low ESR input capacitor sized for the maximum RMS current must be used. The maximum RMS capacitor current is given by:

$$I_{RMS} = I_{OMAX} \times \frac{[V_{OUT}(V_{IN} - V_{OUT})]^{\frac{1}{2}}}{V_{IN}}$$

It indicates a maximum value at  $V_{IN} = 2V_{OUT}$ , where  $I_{RMS} = I_{OUT}/2$ . This simple worst-case condition is commonly used for design because even significant deviations do not much relieve. The selection of  $C_{OUT}$  is determined by the Effective Series Resistance (ESR) that is required to minimize output voltage ripple and load step transients, as well as the amount of bulk capacitor that is necessary to ensure that the control loop is stable. Loop stability can be also checked by viewing the load step transient response as described in the following section. The output ripple,  $\Delta V_{OUT}$ , is determined by:

$$\Delta V_{OUT} \leq \Delta I_L \left[ ESR + \frac{1}{8 \times f \times C_{OUT}} \right]$$

The output ripple is the highest at the maximum input voltage since  $\Delta I_L$  increases with input voltage.

### 3. Load Transient

A switching regulator typically takes several cycles to respond to the load current step. When a load step occurs,  $V_{OUT}$  immediately shifts by an amount equal to  $\Delta I_{LOAD} \times ESR$ , where ESR is the effective series resistance of output capacitor.  $\Delta I_{LOAD}$  also begins to charge or discharge  $C_{OUT}$  generating a feedback error signal used by the regulator to return  $V_{OUT}$  to its steady-state value. During the recovery time,  $V_{OUT}$  can be monitored for overshoot or ringing that would indicate a stability problem.

### 4. Output Voltage Setting

The output voltage of AUR9705 can be adjusted by a resistive divider according to the following formula:

$$V_{OUT} = V_{FB} \times \left(1 + \frac{R_1}{R_2}\right) = 0.6V \times \left(1 + \frac{R_1}{R_2}\right)$$

The resistive divider senses the fraction of the output voltage as shown in Figure of Setting the Output Voltage.

**Application Information** (continued)

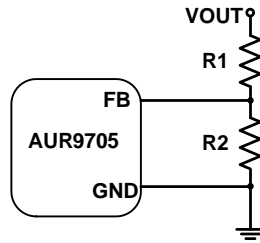

Setting the Output Voltage

**5. Efficiency Considerations**

The efficiency of switching regulator is equal to the output power divided by the input power times 100%. It is usually useful to analyze the individual losses to determine what is limiting efficiency and which change could produce the largest improvement. Efficiency can be expressed as:

$$\text{Efficiency} = 100\% - L_1 - L_2 - \dots$$

Where L1, L2, etc. are the individual losses as a percentage of input power.

Although all dissipative elements in the regulator produce losses, two major sources usually account for most of the power losses:  $V_{IN}$  quiescent current and  $I^2R$  losses. The  $V_{IN}$  quiescent current loss dominates the efficiency loss at very light load currents and the  $I^2R$  loss dominates the efficiency loss at medium to heavy load current.

**5.1** The  $V_{IN}$  quiescent current loss comprises two parts: the DC bias current as given in the electrical characteristics and the internal MOSFET switch gate charge currents. The gate charge current results from switching the gate capacitance of the internal power MOSFET switches. Each cycle the gate is switched from high to low, then to high again, and the packet of charge,  $dQ$  moves from  $V_{IN}$  to ground. The resulting  $dQ/dt$  is the current out of  $V_{IN}$  that is typically larger than the internal DC bias current. In continuous mode,

$$I_{GATE} = f \times (Q_P + Q_N)$$

Where  $Q_P$  and  $Q_N$  are the gate charge of power PMOSFET and NMOSFET switches. Both the DC bias current and gate charge losses are proportional to the  $V_{IN}$  and this effect will be more serious at higher input voltages.

**5.2**  $I^2R$  losses are calculated from internal switch resistance,  $R_{SW}$  and external inductor resistance  $R_L$ . In continuous mode, the average output current flowing through the inductor is chopped between power PMOSFET switch and NMOSFET switch. Then, the series resistance looking into the LX pin is a function of both PMOSFET  $R_{DS(ON)}$  and NMOSFET

$R_{DS(ON)}$  resistance and the duty cycle (D):

$$R_{SW} = R_{DS(ON)P} \times D + R_{DS(ON)N} \times (1 - D)$$

Therefore, to obtain the  $I^2R$  losses, simply add  $R_{SW}$  to  $R_L$  and multiply the result by the square of the average output current.

Other losses including  $C_{IN}$  and  $C_{OUT}$  ESR dissipative losses and inductor core losses generally account for less than 2% of total additional loss.

**6. Thermal Characteristics**

In most applications, the part does not dissipate much heat due to its high efficiency. However, in some conditions when the part is operating in high ambient temperature with high  $R_{DS(ON)}$  resistance and high duty cycles, such as in LDO mode, the heat dissipated may exceed the maximum junction temperature. To avoid the part from exceeding maximum junction temperature, the user should do some thermal analysis. The maximum power dissipation depends on the layout of PCB, the thermal resistance of IC package, the rate of surrounding airflow and the temperature difference between junction and ambient.

**Ordering Information**

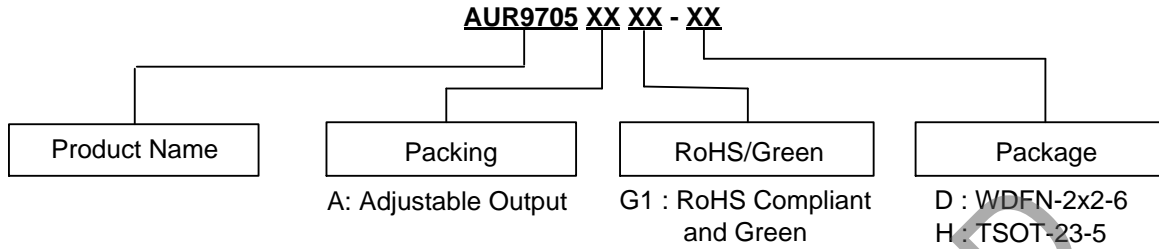

Package	Temperature Range	Part Number	Marking ID	Packing
WDFN-2x2-6	-40 to +80°C	AUR9705AGD	705	Tape & Reel
TSOT-23-5		AUR9705AGH	9705AG	Tape & Reel

**Package Outline Dimensions** (All dimensions in mm (inch).)

Please see <http://www.diodes.com/package-outlines.html> for the latest version.

(1) Package Type: WDFN-2x2-6

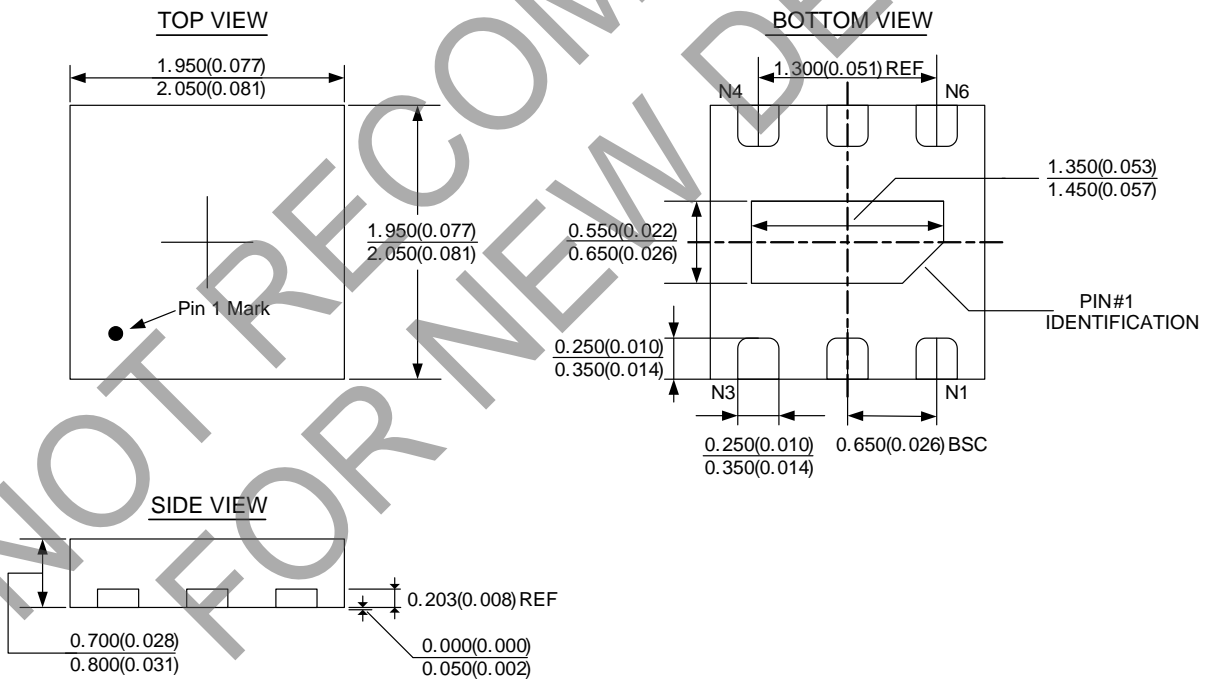

**Package Outline Dimensions** (continued) ( All dimensions in mm(inch).)

Please see <http://www.diodes.com/package-outlines.html> for the latest version.

(2) Package Type: TSOT-23-5

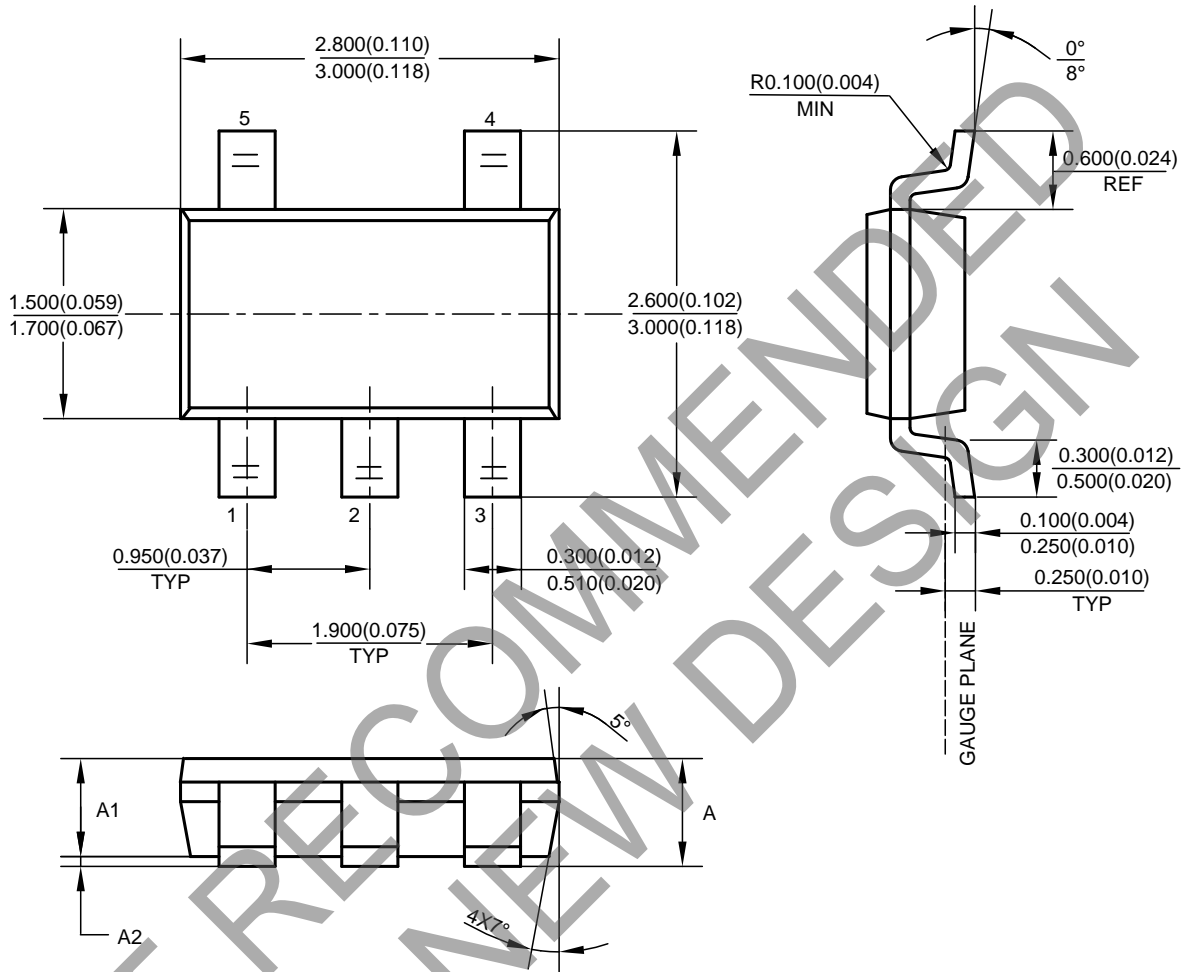

Symbol	A				A1				A2			
	min(mm)	max(mm)	min(inch)	max(inch)	min(mm)	max(mm)	min(inch)	max(inch)	min(mm)	max(mm)	min(inch)	max(inch)
Option1	0.700	0.900	0.028	0.035	0.700	0.800	0.028	0.031	0.000	0.100	0.000	0.004
Option2	-	1.000	-	0.039	0.840	0.900	0.033	0.035	0.010	0.100	0.000	0.004

**Suggested Pad Layout**

Please see <http://www.diodes.com/package-outlines.html> for the latest version.

(1) Package Type: WDFN-2x2-6

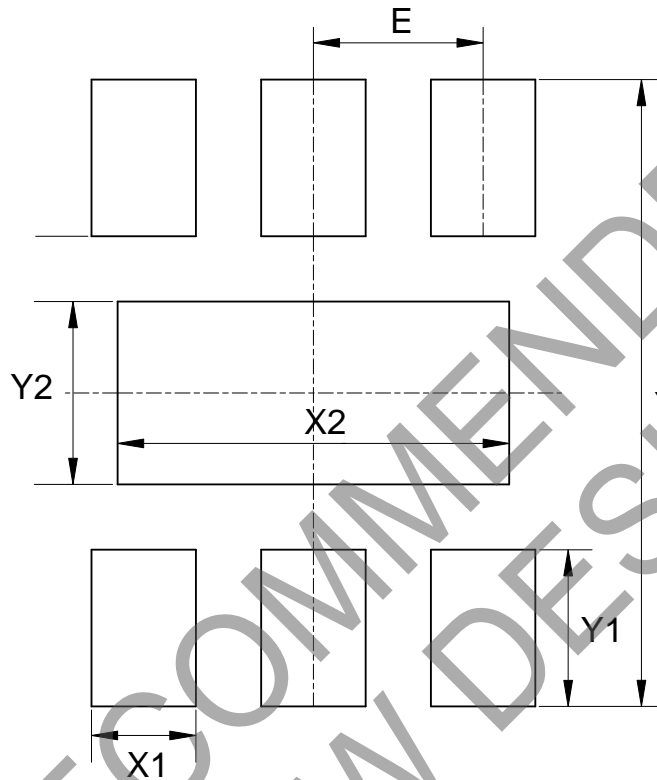

Dimensions	Y (mm)/(inch)	X1 (mm)/(inch)	Y1 (mm)/(inch)	X2 (mm)/(inch)	Y2 (mm)/(inch)	E (mm)/(inch)
Value	2.400/0.094	0.400/0.016	0.600/0.024	1.500/0.059	0.700/0.028	0.650/0.026

**Suggested Pad Layout** (continued)

Please see <http://www.diodes.com/package-outlines.html> for the latest version.

(2) Package Type: TSOT-23-5

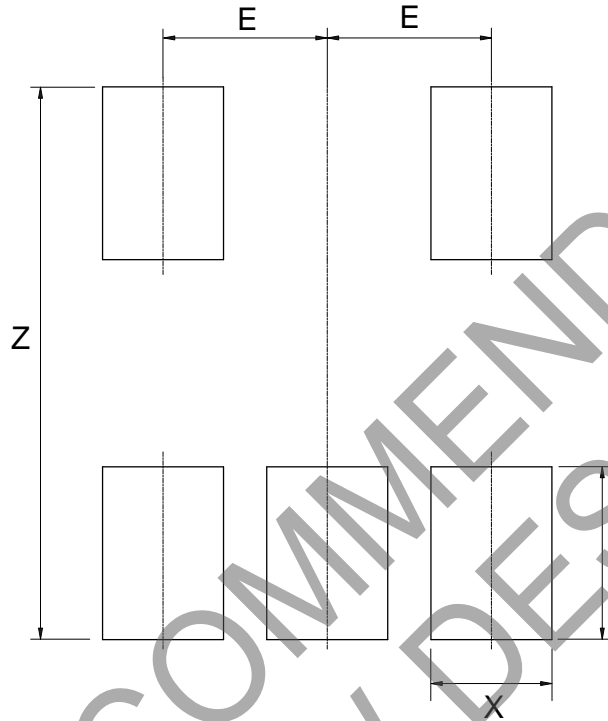

Dimensions	E (mm)/(inch)	X (mm)/(inch)	Y (mm)/(inch)	Z (mm)/(inch)
Value	0.950/0.037	0.700/0.028	1.000/0.039	3.199/0.126

**IMPORTANT NOTICE**

DIODES INCORPORATED MAKES NO WARRANTY OF ANY KIND, EXPRESS OR IMPLIED, WITH REGARDS TO THIS DOCUMENT, INCLUDING, BUT NOT LIMITED TO, THE IMPLIED WARRANTIES OF MERCHANTABILITY AND FITNESS FOR A PARTICULAR PURPOSE (AND THEIR EQUIVALENTS UNDER THE LAWS OF ANY JURISDICTION).

Diodes Incorporated and its subsidiaries reserve the right to make modifications, enhancements, improvements, corrections or other changes without further notice to this document and any product described herein. Diodes Incorporated does not assume any liability arising out of the application or use of this document or any product described herein; neither does Diodes Incorporated convey any license under its patent or trademark rights, nor the rights of others. Any Customer or user of this document or products described herein in such applications shall assume all risks of such use and will agree to hold Diodes Incorporated and all the companies whose products are represented on Diodes Incorporated website, harmless against all damages.

Diodes Incorporated does not warrant or accept any liability whatsoever in respect of any products purchased through unauthorized sales channel. Should Customers purchase or use Diodes Incorporated products for any unintended or unauthorized application, Customers shall indemnify and hold Diodes Incorporated and its representatives harmless against all claims, damages, expenses, and attorney fees arising out of, directly or indirectly, any claim of personal injury or death associated with such unintended or unauthorized application.

Products described herein may be covered by one or more United States, international or foreign patents pending. Product names and markings noted herein may also be covered by one or more United States, international or foreign trademarks.

This document is written in English but may be translated into multiple languages for reference. Only the English version of this document is the final and determinative format released by Diodes Incorporated.

**LIFE SUPPORT**

Diodes Incorporated products are specifically not authorized for use as critical components in life support devices or systems without the express written approval of the Chief Executive Officer of Diodes Incorporated. As used herein:

A. Life support devices or systems are devices or systems which:

1. are intended to implant into the body, or
2. support or sustain life and whose failure to perform when properly used in accordance with instructions for use provided in the labeling can be reasonably expected to result in significant injury to the user.

B. A critical component is any component in a life support device or system whose failure to perform can be reasonably expected to cause the failure of the life support device or to affect its safety or effectiveness.

Customers represent that they have all necessary expertise in the safety and regulatory ramifications of their life support devices or systems, and acknowledge and agree that they are solely responsible for all legal, regulatory and safety-related requirements concerning their products and any use of Diodes Incorporated products in such safety-critical, life support devices or systems, notwithstanding any devices- or systems-related information or support that may be provided by Diodes Incorporated. Further, Customers must fully indemnify Diodes Incorporated and its representatives against any damages arising out of the use of Diodes Incorporated products in such safety-critical, life support devices or systems.

Copyright © 2019, Diodes Incorporated

[www.diodes.com](http://www.diodes.com)

## Looking for pricing, stock, or lifecycle information?

Click below to explore more details on WIN SOURCE:

 [View AUR9705AGH](#) on WIN SOURCE

 [Diodes Incorporated](#) Information

## Optimize Your Supply Chain with WIN SOURCE Solutions

-  Global Sourcing Solution
-  Obsolete Management
-  Cost Control Management
-  Shortage Management
-  Alternative Solution
-  Excess Inventory Management