



**THE DATASHEET OF
SG3526DW**



REGULATING PULSE WIDTH MODULATOR

DESCRIPTION

The SG1526 is a high-performance monolithic pulse width modulator circuit designed for fixed-frequency switching regulators and other power control applications. Included in an 18-pin dual-in-line package are a temperature compensated voltage reference, sawtooth oscillator, error amplifier, pulse width modulator, pulse metering and steering logic, and two low impedance power drivers. Also included are protective features such as soft-start and undervoltage lockout, digital current limiting, double pulse inhibit, a data latch for single pulse metering, adjustable deadtime, and provision for symmetry correction inputs. For ease of interface, all digital control ports are TTL and B-series CMOS compatible. Active LOW logic design allows wired-OR connections for maximum flexibility. This versatile device can be used to implement single-ended or push-pull switching regulators of either polarity, both transformerless and transformer coupled. The SG1526 is characterized for operation over the full military ambient junction temperature range of -55°C to +150°C. The SG2526 is characterized for operation from -25°C to +150°C, and the SG3526 is characterized for operation from 0°C to +125°C.

FEATURES

- 8V to 35V Operation
- 5V Reference Trimmed to $\pm 1\%$
- 1Hz to 350kHz Oscillator Range
- Dual 100mA Source/Sink Outputs
- Digital Current Limiting
- Double Pulse Suppression
- Programmable Deadtime
- Undervoltage Lockout
- Single Pulse Metering
- Programmable Soft-start
- Wide Current Limit Common Mode
- Range TTL/CMOS Compatible Logic
- Ports Symmetry Correction Capability
- Guaranteed 6 Unit Synchronization

HIGH RELIABILITY FEATURES

- Available to MIL-STD-883, ¶ 1.2.1
- Available to DSCC - Standard Microcircuit Drawing (SMD)
- Radiation data available
- MSC-AMS level "S" processing available

BLOCK DIAGRAM

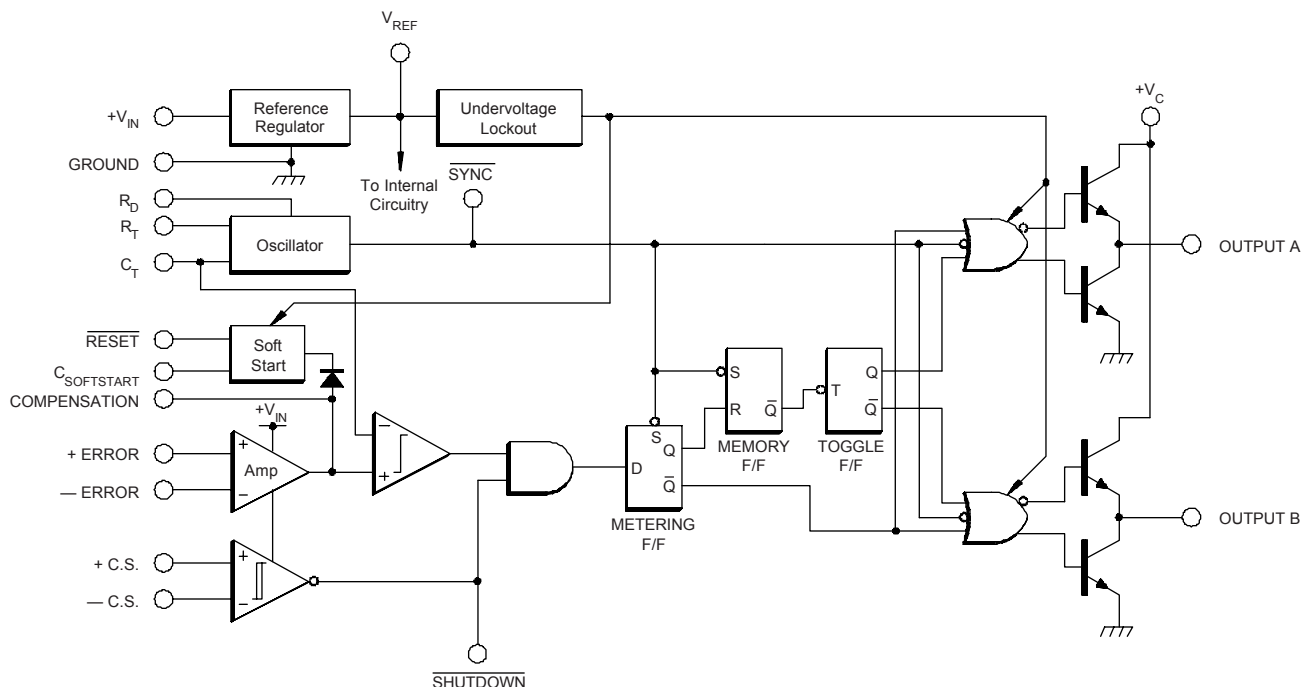

ABSOLUTE MAXIMUM RATINGS

Input Voltage (V_{IN})	40V
Collector Supply Voltage (V_C)	40V
Logic Inputs	-0.3V to 5.5V
Analog Inputs	-0.3V to V_{IN}
Source/Sink Load Current (each output)	200mA
Reference Load Current	50mA

Note 1. Exceeding these ratings could cause damage to the device.

Logic Sink Current	15mA
Operating Junction Temperature	
Hermetic (J, L Packages)	150°C
Plastic (N, DW Packages)	150°C
Storage Temperature Range	-65°C to 150°C
Lead Temperature (Soldering, 10 Seconds)	300°C
RoHS Peak Package Solder Reflow Temp. (40 sec. max. exp.)	260°C (+0, -5)

THERMAL DATA

J Package:

Thermal Resistance-Junction to Case, θ_{JC}	25°C/W
Thermal Resistance-Junction to Ambient, θ_{JA}	70°C/W

N Package:

Thermal Resistance-Junction to Case, θ_{JC}	30°C/W
Thermal Resistance-Junction to Ambient, θ_{JA}	60°C/W

DW Package:

Thermal Resistance-Junction to Case, θ_{JC}	35°C/W
Thermal Resistance-Junction to Ambient, θ_{JA}	90°C/W

L Package:

Thermal Resistance-Junction to Case, θ_{JC}	35°C/W
Thermal Resistance-Junction to Ambient, θ_{JA}	120°C/W

Note A. Junction Temperature Calculation: $T_J = T_A + (P_D \times \theta_{JA})$.

Note B. The above numbers for θ_{JC} are maximums for the limiting thermal resistance of the package in a standard mounting configuration. The θ_{JA} numbers are meant to be guidelines for the thermal performance of the device/pc-board system. All of the above assume no ambient airflow.

RECOMMENDED OPERATING CONDITIONS (Note 2)

Input Voltage	8V to 35V
Collector Supply Voltage	4.5V to 35V
Sink/Source Load Current (each output)	0 to 100mA
Reference Load Current	0 to 20mA
Oscillator Frequency Range	1Hz to 350kHz
Oscillator Timing Resistor	2k Ω to 150k Ω

Note 2. Range over which the device is functional.

Oscillator Timing Capacitor	1nF to 20 μ F
Available Deadtime Range at 40kHz	3% to 50%
Operating Ambient Temperature Range:	
SG1526	-55°C to 125°C
SG2526	-25°C to 85°C
SG3526	0°C to 70°C

ELECTRICAL CHARACTERISTICS

(Unless otherwise specified, these specifications apply over the operating ambient temperatures for SG1526 with $-55^\circ\text{C} \leq T_A \leq 125^\circ\text{C}$, SG2526 with $-25^\circ\text{C} \leq T_A \leq 85^\circ\text{C}$, SG3526 with $0^\circ\text{C} \leq T_A \leq 70^\circ\text{C}$, and $V_{IN} = 15\text{V}$. Low duty cycle pulse testing techniques are used which maintains junction and case temperatures equal to the ambient temperature.)

Parameter	Test Conditions	SG1526/2526			SG3526			Units
		Min.	Typ.	Max.	Min.	Typ.	Max.	
Reference Section (Note 3)								
Output Voltage	$T_J = 25^\circ\text{C}$	4.95	5.00	5.05	4.90	5.00	5.10	V
Line Regulation	$V_{IN} = 8$ to 35V		10	30		10	30	mV
Load Regulation	$I_L = 0$ to 20mA		10	30		10	50	mV
Temperature Stability (Note 9)	Over Operating T_J		15	50		15	50	mV
Total Output Voltage Range (Note 9)	Over Recommended Operating Conditions	4.90	5.00	5.10	4.85	5.00	5.15	V
Short Circuit Current	$V_{REF} = 0\text{V}$		50	125		50	125	mA
Undervoltage Lockout Section								
$\overline{\text{RESET}}$ Output Voltage	$V_{REF} = 3.8\text{V}$		0.2	0.4		0.2	0.4	V
$\overline{\text{RESET}}$ Output Voltage	$V_{REF} = 4.8\text{V}$	2.4	4.8		2.4	4.8		V

ELECTRICAL CHARACTERISTICS (continued)

Parameter	Test Conditions	SG1526/2526			SG3526			Units
		Min.	Typ.	Max.	Min.	Typ.	Max.	
Oscillator Section (Note 4)								
Initial Accuracy	$T_J = 25^\circ\text{C}$		± 3	± 8		± 3	± 8	%
Voltage Stability	$V_{IN} = 8$ to 35V		0.5	1.0		0.5	1.0	%
Temperature Stability (Note 9)	Over Operating T_J		7	10		5	10	%
Minimum Frequency (Note 9)	$R_T = 150\text{k}\Omega$, $C_T = 20\mu\text{F}$			1.0			1.0	Hz
Maximum Frequency	$R_T = 2\text{k}\Omega$, $C_T = 1.0\text{nF}$	350			350			kHz
Sawtooth Peak Voltage	$V_{IN} = 35\text{V}$		3.0	3.5		3.0	3.5	V
Sawtooth Valley Voltage	$V_{IN} = 8\text{V}$	0.5	1.0		0.5	1.0		V
Error Amplifier Section (Note 5)								
Input Offset Voltage	$R_S \leq 2\text{k}\Omega$		2	5		2	10	mV
Input Bias Current			-350	-1000		-350	-2000	nA
Input Offset Current			35	100		35	200	nA
DC Open Loop Gain	$R_L \geq 10\text{M}\Omega$, $T_J = 25^\circ\text{C}$	64	72		60	72		dB
High Output Voltage	$V_{PIN1} - V_{PIN2} \geq 150\text{mV}$, $I_{SOURCE} = 100\mu\text{A}$	3.6	4.2		3.6	4.2		V
Low Output Voltage	$V_{PIN2} - V_{PIN1} \geq 150\text{mV}$, $I_{SINK} = 100\mu\text{A}$		0.2	0.4		0.2	0.4	V
Common Mode Rejection	$R_S \leq 2\text{k}\Omega$	70	94		70	94		dB
Supply Voltage Rejection	$V_{IN} = 8\text{V}$ to 35V	66	80		66	80		dB
PWM Comparator Section (Note 4)								
Minimum Duty Cycle	$V_{COMPENSATION} = 0.4\text{V}$			0			0	%
Maximum Duty Cycle	$V_{COMPENSATION} = 3.6\text{V}$	45	49		45	49		%
Digital Ports (SYNC, SHUTDOWN, and RESET)								
HIGH Output Voltage	$I_{SOURCE} = 40\mu\text{A}$	2.4	4		2.4	4		V
LOW Output Voltage	$I_{SINK} = 3.6\text{mA}$		0.2	0.4		0.2	0.4	V
HIGH Input Current	$V_{IH} = 2.4\text{V}$		-125	-300		-125	-300	μA
LOW Input Current	$V_{IL} = 0.4\text{V}$		-225	-500		-225	-500	μA
Current Limit Comparator Section (Note 6)								
Sense Voltage	$R_S \leq 50\Omega$, $T_J = 25^\circ\text{C}$	90	100	110	80	100	120	mV
Input Bias Current			-3	-10		-3	-10	μA
Soft-Start Section								
Error Clamp Voltage	$\overline{\text{RESET}} = 0.4\text{V}$		0.1	0.4		0.1	0.4	V
C_S Charging Current	$\overline{\text{RESET}} = 2.4\text{V}$	50	100	200	50	100	200	μA
Output Drivers (each output) (Note 7)								
HIGH Output Voltage	$I_{SOURCE} = 20\text{mA}$	12.5	13.5		12.5	13.5		V
	$I_{SOURCE} = 100\text{mA}$	12	13		12	13		V
LOW Output Voltage	$I_{SINK} = 20\text{mA}$		0.2	0.3		0.2	0.3	V
	$I_{SINK} = 100\text{mA}$		1.2	2		1.2	2	V
Collector Leakage	$V_C = 40\text{V}$		50	150		50	150	μA
Rise Time	$C_L = 1000\text{pF}$		0.3	0.6		0.3	0.6	μs
Fall Time	$C_L = 1000\text{pF}$		0.1	0.2		0.1	0.2	μs
Power Consumption Section (Note 8)								
Standby Current	$\overline{\text{SHUTDOWN}} = 0.4\text{V}$		18	30		18	30	mA

 Note 3. $I_L = 0\text{mA}$

 Note 4. $F_{OSC} = 40\text{kHz}$ ($R_T = 4.12\text{k}\Omega \pm 1\%$, $C_T = .01\mu\text{F} \pm 1\%$, $R_D = 0\Omega$)

 Note 5. $V_{CM} = 0$ to 5.2V

 Note 6. $V_{CM} = 0$ to 12V

 Note 7. $V_C = 15\text{V}$

 Note 8. $V_{IN} = 35\text{V}$

Note 9. These parameters, although guaranteed over the recommended operating conditions, are not tested in production.

CHARACTERISTIC CURVES

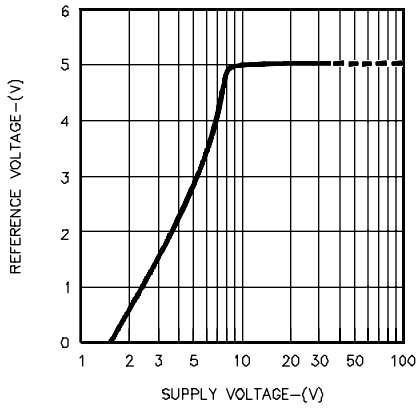

FIGURE 1.
REFERENCE VOLTAGE VS. SUPPLY VOLTAGE

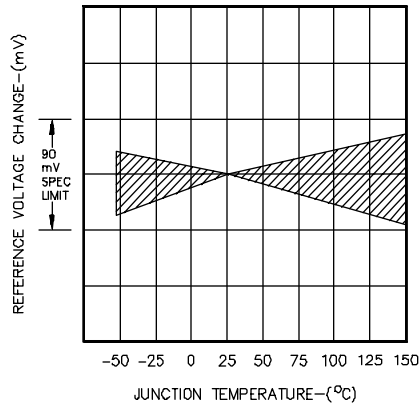

FIGURE 2.
REFERENCE TEMPERATURE STABILITY

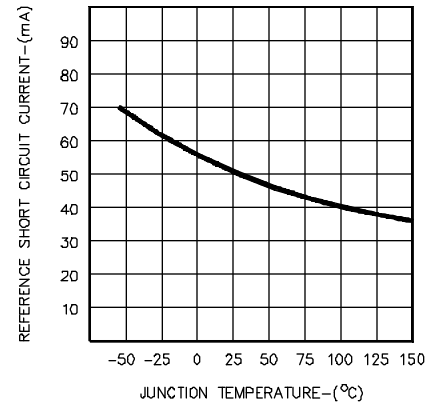

FIGURE 3.
REFERENCE SHORT CIRCUIT CURRENT

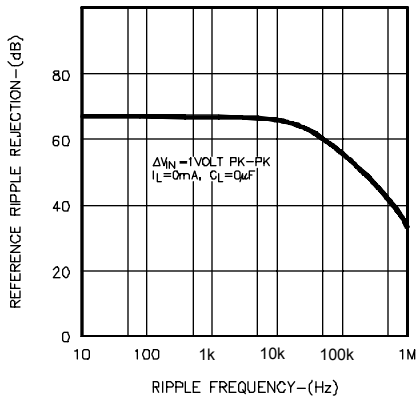

FIGURE 4.
REFERENCE RIPPLE REJECTION

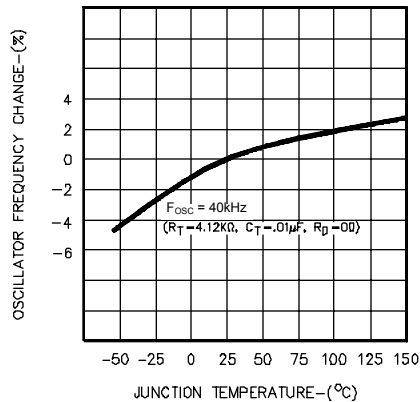

FIGURE 5.
OSCILLATOR FREQUENCY TEMPERATURE STABILITY

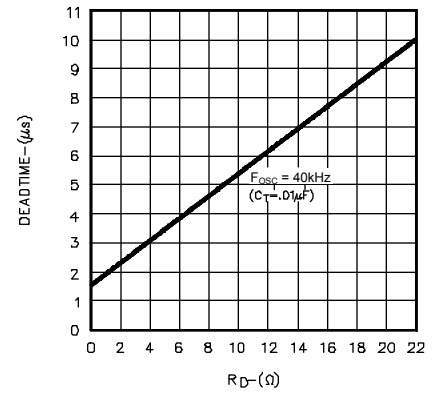

FIGURE 6.
OUTPUT DRIVER DEADTIME VS. R_D VALUE

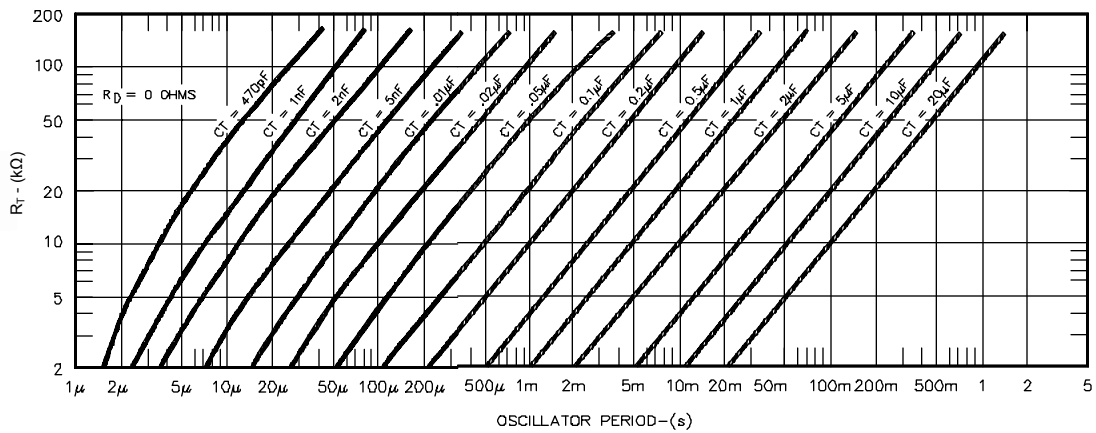

FIGURE 7.
OSCILLATOR PERIOD VS. R_T AND C_T

CHARACTERISTIC CURVES (continued)

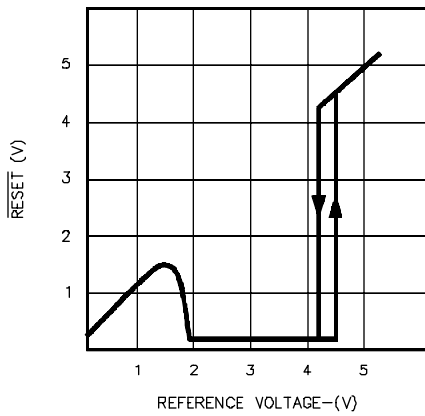

FIGURE 8. UNDERVOLTAGE LOCKOUT CHARACTERISTIC

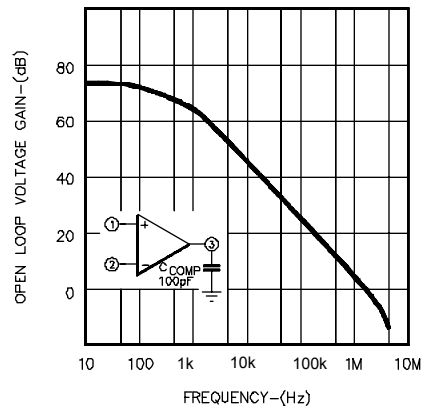

FIGURE 9. ERROR AMPLIFIER OPEN LOOP GAIN VS. FREQUENCY

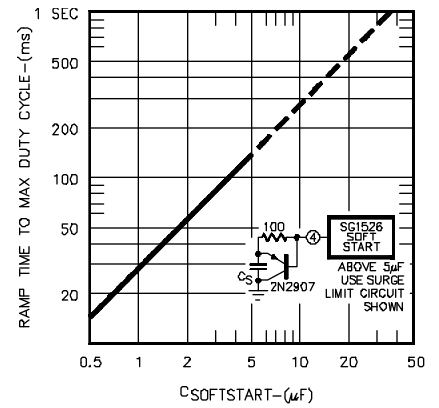

FIGURE 10. SOFTSTART TIME CONSTANT VS. C_S

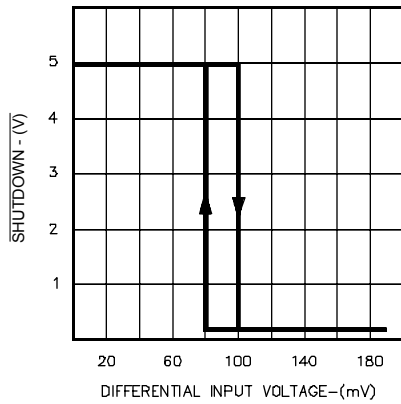

FIGURE 11. CURRENT LIMIT TRANSFER FUNCTION

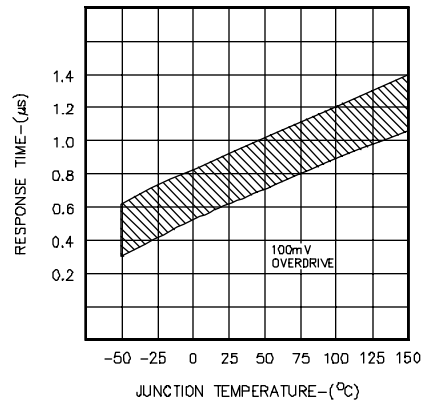

FIGURE 12. COMPARATOR INPUT TO DRIVER OUTPUT DELAY

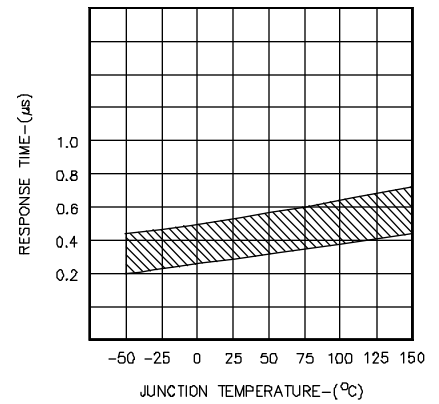

FIGURE 13. SHUTDOWN INPUT TO DRIVER OUTPUT DELAY

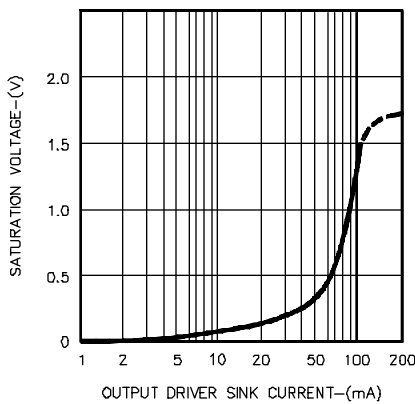

FIGURE 14. OUTPUT DRIVER SATURATION VOLTAGE VS. I_{SINK}

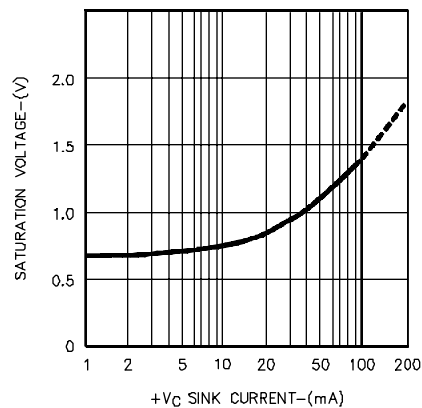

FIGURE 15. OUTPUT SUPPLY SATURATION VOLTAGE VS. I_{SINK}

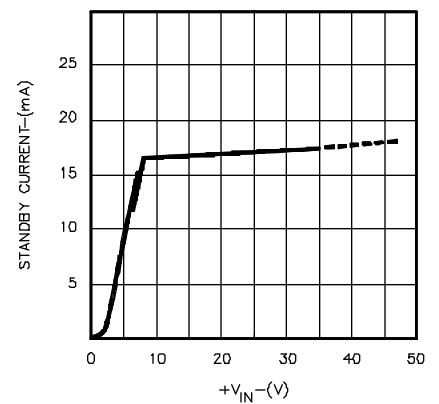

FIGURE 16. STANDBY CURRENT VS. SUPPLY VOLTAGE

APPLICATION INFORMATION

VOLTAGE REFERENCE

The reference regulator of the SG1526 is based on a temperature compensated Zener diode. The circuitry is fully active at supply voltages above +8 volts, and provides up to 20mA of load current to external circuitry at +5.0 volts. In systems where additional current is required, an external PNP transistor can be used to boost the available current. A rugged low frequency audio-type transistor should be used, and lead lengths between the PWM and transistor should be as short as possible to minimize the risk of oscillations. Even so, some types of transistors may require collector-base capacitance for stability. Up to 1 amp of load current can be obtained with excellent regulation if the device selected maintains high current gain.

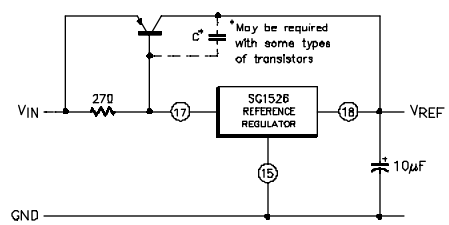

FIGURE 17.
EXTENDING REFERENCE OUTPUT CURRENT

UNDERVOLTAGE LOCKOUT

The undervoltage lockout circuit protects the SG1526 and the power devices it controls from inadequate supply voltage. If $+V_{IN}$ is too low, the circuit disables the output drivers and holds the $\overline{\text{RESET}}$ pin LOW. This prevents spurious output pulses while the control circuitry is stabilizing, and holds the soft-start timing capacitor in a discharged state.

The circuit consists of a +1.2 volt bandgap reference and comparator circuit which is active when the reference voltage has risen to $3V_{BE}$ or 1.8 volts at 25°C. When the reference voltage rises to approximately +4.4 volts, the circuit enables the output drivers and releases the $\overline{\text{RESET}}$ pin, allowing a normal soft-start. The comparator has 200mV of hysteresis to minimize oscillation at the trip point. When $+V_{IN}$ to the PWM is removed and the reference drops to +4.2 volts, the undervoltage circuit pulls $\overline{\text{RESET}}$ LOW again. The soft-start capacitor is immediately discharged, and the PWM is ready for another soft-start cycle.

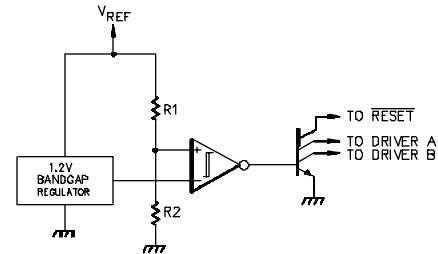

FIGURE 18.
SIMPLIFIED UNDERVOLTAGE LOCKOUT

The SG1526 can operate from a +5 volt supply by connecting the V_{REF} pin to the $+V_{IN}$ pin and maintaining the supply between +4.8 and +5.2 volts.

SOFT-START CIRCUIT

The soft-start circuit protects the power transistors and rectifier diodes from high current surges during power supply turn-on. When supply voltage is first applied to the SG1526, the undervoltage lockout circuit holds $\overline{\text{RESET}}$ LOW with Q3. Q1 is turned on, which holds the soft-start capacitor voltage at zero. The second collector of Q1 clamps the output error amplifier to ground, guaranteeing zero duty cycle at the driver outputs. When the supply voltage reaches normal operating range, $\overline{\text{RESET}}$ will go HIGH. Q1 turns off, allowing the internal 100μA current source to charge C_S . Q2 clamps the error amplifier output to $1V_{BE}$ above the voltage on C_S . As the soft-start voltage ramps up to +5 volts, the duty cycle of the PWM linearly increases to whatever value the voltage regulation loop requires for an error null. Figure 10 gives the timing relationship between C_S and ramp time to 100% duty cycle.

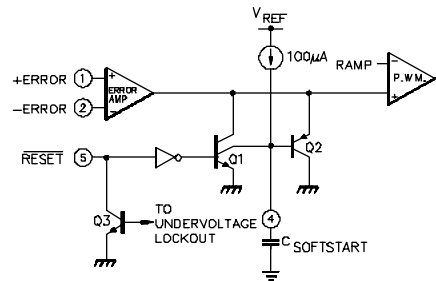

FIGURE 19.
SOFT-START CIRCUIT SCHEMATIC

DIGITAL CONTROL PORTS

The three digital control ports of the SG1526 are bi-directional. Each pin can drive TTL and 5 volt CMOS logic directly, up to a fan-out of 10 low-power Schottky gates. Each pin can also be directly driven by open-collector voltage comparators; fan-in is equivalent to 1 low-power Schottky gate. Each port is normally HIGH; the pin is pulled LOW to activate the particular function. Driving $\overline{\text{SYNC}}$ LOW initiates a discharge cycle in the oscillator. Pulling $\overline{\text{SHUTDOWN}}$ LOW immediately inhibits all PWM output pulses. Holding $\overline{\text{RESET}}$ LOW discharges the soft-start capacitor. The logic threshold is +1.1 volts at 25°C. Noise immunity can be gained at the expense of fan-out with an external 2k pullup resistor to +5 volts.

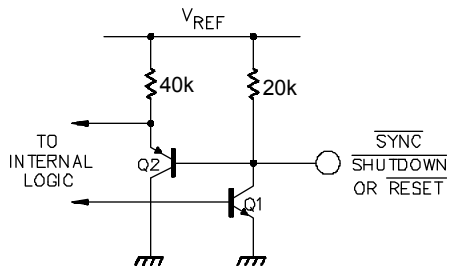

FIGURE 20.
DIGITAL CONTROL PORT SCHEMATIC

APPLICATION INFORMATION (continued)

OSCILLATOR

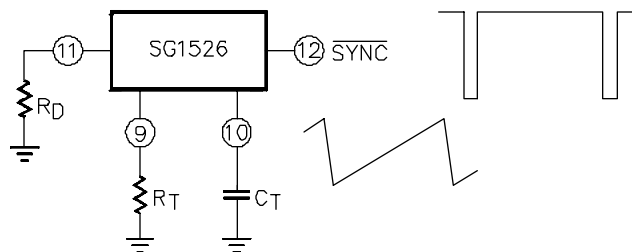

FIGURE 21 - OSCILLATOR CONNECTIONS AND WAVEFORMS

The oscillator is programmed for frequency and deadtime with three components: R_T , C_T , and R_D . Two waveforms are generated: a sawtooth waveform at pin 10 for pulse width modulation, and a logic clock at pin 12. The following procedure is recommended for choosing timing values:

1. With $R_D = 0\Omega$ (pin 11 shorted to ground) select values for R_T and C_T from Figure 7 to give the desired oscillator period. Remember that the frequency at each driver output is half the oscillator frequency, and the frequency at the $+V_C$ terminal is the same as the oscillator frequency.
2. If more dead time is required, select a larger value of R_D using Figure 6 as a guide. At 40kHz dead time increases by 400nSec/ohm.
3. Increasing the dead time will cause the oscillator frequency to decrease slightly. Go back and decrease the value of R_T slightly to bring the frequency back to the nominal design value.

The SG1526 can be synchronized to an external logic clock by programming the oscillator to free-run at a frequency 10% slower than the sync frequency. A periodic LOW logic pulse approximately 0.5 μ Sec wide at the $\overline{\text{SYNC}}$ pin will then lock the oscillator to the external frequency.

Multiple devices can be synchronized together by programming one master unit for the desired frequency, and then sharing its sawtooth and clock waveforms with the slave units. All C_T terminals are connected to the C_T pin of the master, and all $\overline{\text{SYNC}}$ terminals are likewise connected to the $\overline{\text{SYNC}}$ pin of the master. Slave R_T terminals should not be left open nor should they be tied to the +5V reference; at least 50k should be connected to each pin. Slave R_D terminals may be either left open or grounded.

ERROR AMPLIFIER

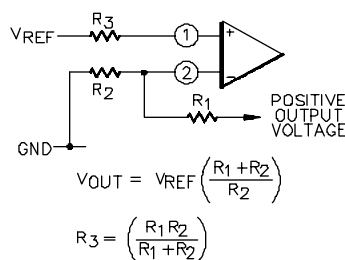

FIGURE 22A

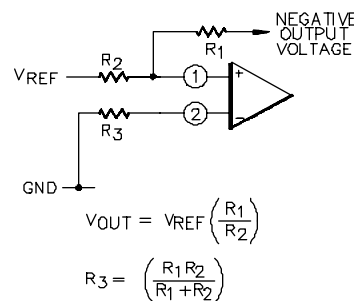

FIGURE 22B

ERROR AMPLIFIER CONNECTIONS

The error amplifier is a transconductance design, with an output impedance of 2 megohms and an effective output capacitance of 100 pF. Since all voltage gain takes place at the output pin, the open-loop gain can be shaped with shunt reactance to ground. For unity gain stability the amplifier requires an additional external 100 pF to ground, resulting in an open-loop pole at 400 Hz.

The input connections to the error amplifier are determined by the polarity of the switching supply output voltage. For positive supplies, the common-mode voltage is +5.0 volts and the feedback connections in Figure 22A are used. With negative supplies, the common-mode voltage is ground and the feedback divider is connected between the negative output and the +5.0 volt reference voltage, as shown in Figure 22B.

APPLICATION INFORMATION (continued)

OUTPUT DRIVERS

The totem-pole output drivers of the SG1526 are designed to source and sink 100mA continuously and 200mA peak. Loads can be driven either from the output pins 13 and 16, or from the $+V_C$ pin, as required. Curves for the saturation voltage at these outputs as a function of load current are found in Figures 14 and 15.

Since the bottom transistor of the totem-pole is allowed to saturate, there is a momentary conduction path from the $+V_C$ terminal to ground during switching. To limit the resulting current spikes a small resistor in series with pin 14 is always recommended. The resistor value is determined by the driver supply voltage, and should be chosen for 200mA peak currents, as shown in Figure 25.

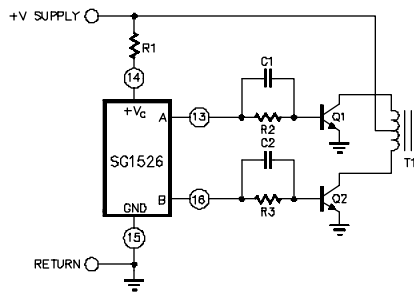

FIGURE 23.
PUSH-PULL CONFIGURATION

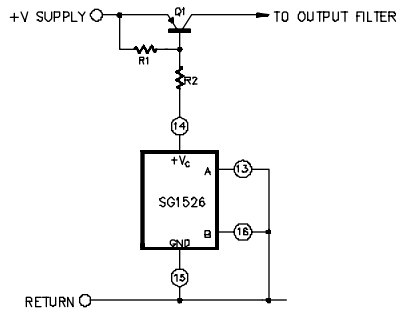

FIGURE 24.
SINGLE-ENDED CONFIGURATION

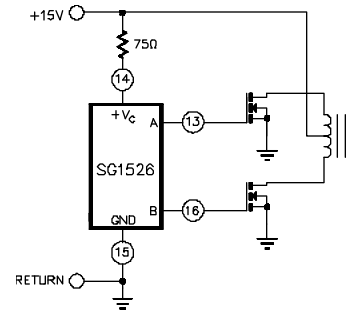
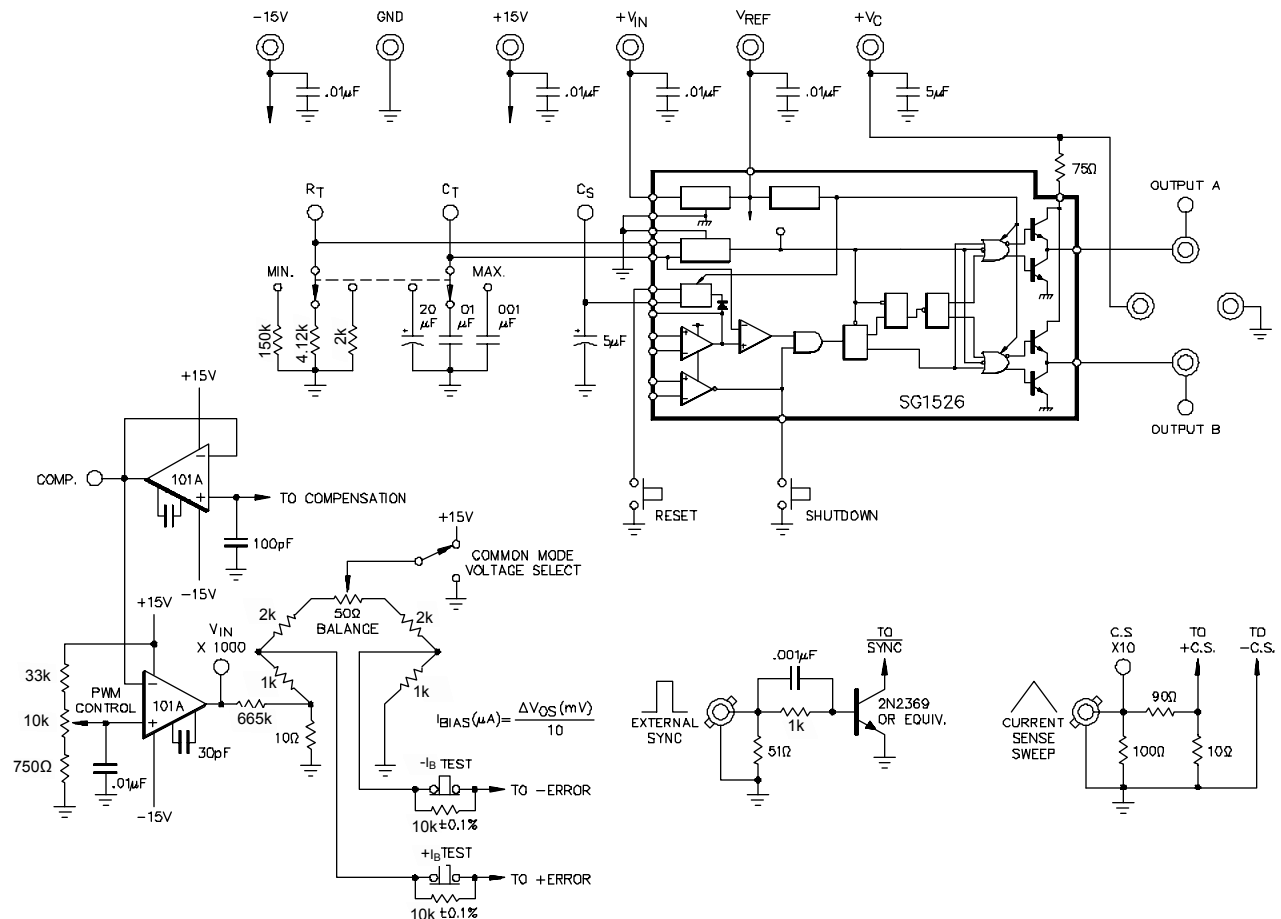
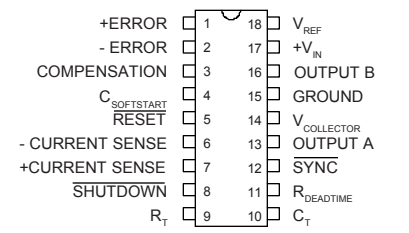
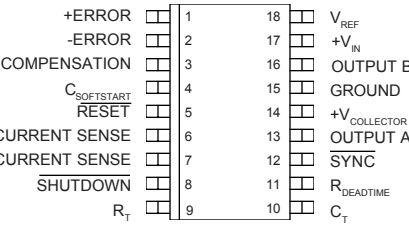
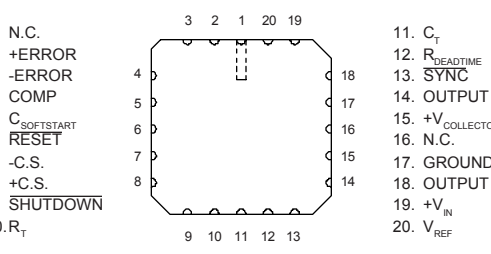

FIGURE 25.
DRIVING N-CHANNEL POWER MOSFETS

SG1526 LAB TEST FIXTURE



CONNECTION DIAGRAMS & ORDERING INFORMATION (See Notes Below)

Package	Part No.	Ambient Temperature Range	Connection Diagram
18-PIN CERAMIC DIP J - PACKAGE	SG1526J-883B SG1526J SG2526J SG3526J	-55°C to 125°C -55°C to 125°C -25°C to 85°C 0°C to 70°C	
18-PIN PLASTIC DIP N - PACKAGE	SG2526N SG3526N	-25°C to 85°C 0°C to 70°C	
		N Package: RoHS Compliant / Pb-free Transition DC: 0503	N Package: RoHS / Pb-free 100% Matte Tin Lead Finish
18-PIN WIDE BODY PLASTIC SOIC DW - PACKAGE	SG2526DW SG3526DW	-25°C to 85°C 0°C to 70°C	
		DW Package: RoHS Compliant / Pb-free Transition DC: 0516	DW Package: RoHS / Pb-free 100% Matte Tin Lead Finish
20-PIN CERAMIC LEADLESS CHIP CARRIER L- PACKAGE	SG1526L-883B SG1526L	-55°C to 125°C -55°C to 125°C	

Note 1. Contact factory for JAN and DESC product availability.

Note 2. All parts are viewed from the top.

Note 3. Hermetic Packages J, L use Pb37/Sn63 hot solder lead finish, contact factory for availability of RoHS versions.

PACKAGE OUTLINE DIMENSIONS

Controlling dimensions are in inches, metric equivalents are shown for general information.

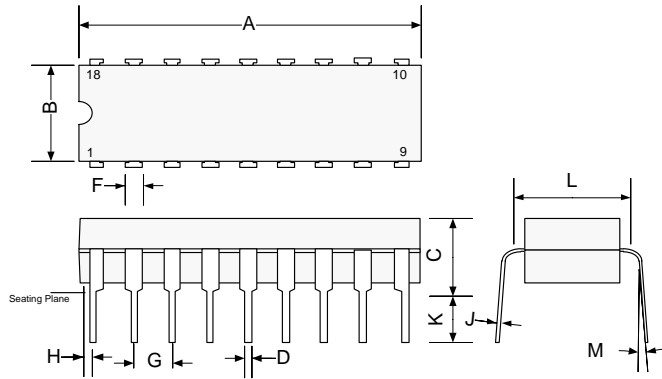

DIM	MILLIMETERS		INCHES	
	MIN	MAX	MIN	MAX
A	-	24.38	-	0.960
B	5.59	7.11	0.220	0.280
C	-	5.08	-	0.200
D	0.38	0.51	0.015	0.020
F	1.02	1.77	0.040	0.070
G	2.54 BSC		0.100 BSC	
H	-	2.03	-	0.080
J	0.20	0.38	0.008	0.015
K	3.18	5.08	0.125	0.200
L	7.37	7.87	0.290	0.310
M	-	15°	-	15°

Note: Dimensions do not include protrusions; these shall not exceed 0.155mm (0.006") on any side. Lead dimension shall not include solder coverage.

Figure 26 · J 18-Pin CERDIP Package Dimensions

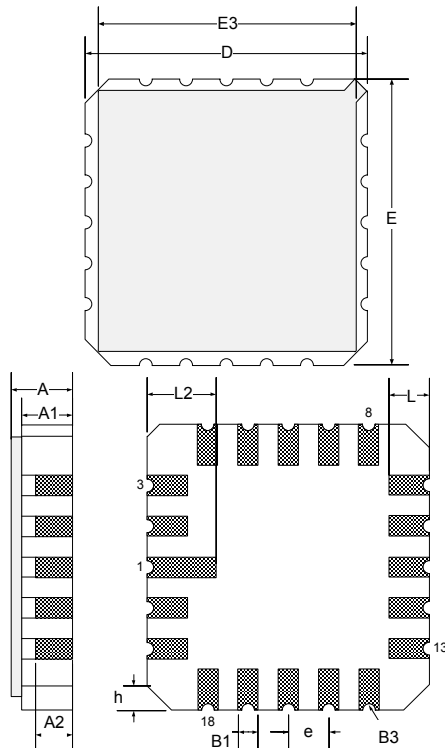

Dim	MILLIMETERS		INCHES	
	MIN	MAX	MIN	MAX
D/E	8.64	9.14	0.340	0.360
E3	-	8.128	-	0.320
e	1.270 BSC		0.050 BSC	
B1	0.635 TYP		0.025 TYP	
L	1.02	1.52	0.040	0.060
A	1.626	2.286	0.064	0.090
h	1.016 TYP		0.040 TYP	
A1	1.372	1.68	0.054	0.066
A2	-	1.168	-	0.046
L2	1.91	2.41	0.075	0.95
B3	0.203R		0.008R	

Note: All exposed metalized area shall be gold plated 60 μ-inch minimum thickness over nickel plated unless otherwise specified in purchase order.

Figure 27 · L 20-Pin Ceramic LCC Package Dimensions

PACKAGE OUTLINE DIMENSIONS (continued)

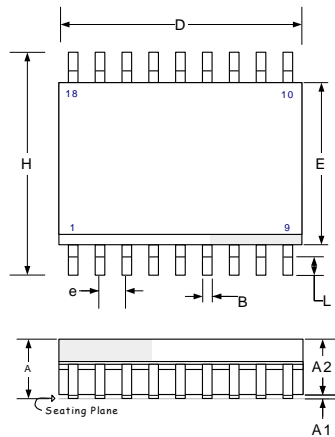

DIM	MILLIMETERS		INCHES	
	MIN	MAX	MIN	MAX
A	2.35	2.65	0.093	0.104
A1	0.10	0.30	0.004	0.012
A2	2.20	2.55	0.086	0.100
B	0.33	0.51	0.013	0.020
c	0.23	0.32	0.009	0.013
D	11.40	11.70	0.449	0.461
E	7.40	7.60	0.291	0.299
e	1.27 BSC		0.05 BSC	
H	10.00	10.65	0.394	0.419
L	0.40	1.27	0.016	0.050
θ	0°	8°	0°	8°
*LC	-	0.10	-	0.004

* Lead Coplanarity

Note: Dimensions do not include mold flash or protrusions; these shall not exceed 0.155mm (0.006") on any side. Lead dimension shall not include solder coverage.

Figure 28 · DW 18-Pin Plastic Wide-body SOIC (SOWB) Package Dimensions

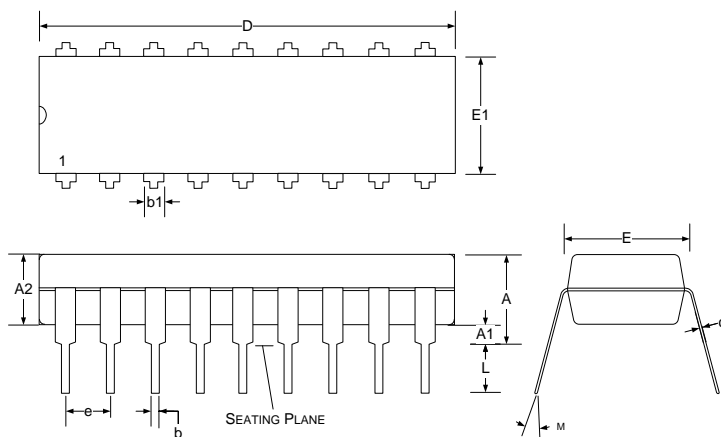

Dim	MILLIMETERS		INCHES	
	MIN	MAX	MIN	MAX
A		5.33		0.210
A1	0.38		0.015	
A2	3.30 Typ		0.130 Typ	
b	0.36	0.56	0.014	0.022
b1	1.14	1.78	0.045	0.070
c	0.20	0.36	0.008	0.014
D	22.35	23.34	0.880	0.920
e	2.54 BSC		0.100 BSC	
E	7.62	8.26	0.300	0.325
E1	6.10	7.11	0.240	0.280
L	2.92	3.81	0.115	0.150
M	-	15°	-	15°

Note: Dimensions do not include mold flash or protrusions; these shall not exceed 0.155mm (0.006") on any side. Lead dimension shall not include solder coverage.

Figure 29 · N 18-Pin Plastic Dual In Line Package Dimensions



Microsemi Corporate Headquarters
One Enterprise, Aliso Viejo,
CA 92656 USA

Within the USA: +1 (800) 713-4113
Outside the USA: +1 (949) 380-6100
Sales: +1 (949) 380-6136
Fax: +1 (949) 215-4996

E-mail: sales.support@microsemi.com



© 2014 Microsemi Corporation. All rights reserved. Microsemi and the Microsemi logo are trademarks of Microsemi Corporation. All other trademarks and service marks are the property of their respective owners.

Microsemi Corporation (Nasdaq: MSCC) offers a comprehensive portfolio of semiconductor and system solutions for communications, defense & security, aerospace and industrial markets. Products include high-performance and radiation-hardened analog mixed-signal integrated circuits, FPGAs, SoCs and ASICs; power management products; timing and synchronization devices and precise time solutions, setting the world's standard for time; voice processing devices; RF solutions; discrete components; security technologies and scalable anti-tamper products; Power-over-Ethernet ICs and midspans; as well as custom design capabilities and services. Microsemi is headquartered in Aliso Viejo, Calif., and has approximately 3,400 employees globally. Learn more at www.microsemi.com.

Microsemi makes no warranty, representation, or guarantee regarding the information contained herein or the suitability of its products and services for any particular purpose, nor does Microsemi assume any liability whatsoever arising out of the application or use of any product or circuit. The products sold hereunder and any other products sold by Microsemi have been subject to limited testing and should not be used in conjunction with mission-critical equipment or applications. Any performance specifications are believed to be reliable but are not verified, and Buyer must conduct and complete all performance and other testing of the products, alone and together with, or installed in, any end-products. Buyer shall not rely on any data and performance specifications or parameters provided by Microsemi. It is the Buyer's responsibility to independently determine suitability of any products and to test and verify the same. The information provided by Microsemi hereunder is provided "as is, where is" and with all faults, and the entire risk associated with such information is entirely with the Buyer. Microsemi does not grant, explicitly or implicitly, to any party any patent rights, licenses, or any other IP rights, whether with regard to such information itself or anything described by such information. Information provided in this document is proprietary to Microsemi, and Microsemi reserves the right to make any changes to the information in this document or to any products and services at any time without notice.

Looking for pricing, stock, or lifecycle information?

Click below to explore more details on WIN SOURCE:

-  [View SG3526DW on WIN SOURCE](#)
-  [Microsemi Corporation](#) Information

Optimize Your Supply Chain with WIN SOURCE Solutions

-  Global Sourcing Solution
-  Obsolete Management
-  Cost Control Management
-  Shortage Management
-  Alternative Solution
-  Excess Inventory Management