



**THE DATASHEET OF  
TSM160N10CZ C0G**



## N-Channel Power MOSFET

100V, 160A, 5.5mΩ

### FEATURES

- Advanced Trench Technology
- Low  $R_{DS(ON)}$  5.5mΩ (Max.)
- Low gate charge typical @ 154nC (Typ.)
- Low Crss typical @ 260pF (Typ.)

### KEY PERFORMANCE PARAMETERS

PARAMETER	VALUE	UNIT
$V_{DS}$	100	V
$R_{DS(on)}$ (max)	5.5	mΩ
$Q_g$	154	nC

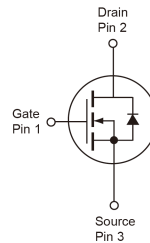
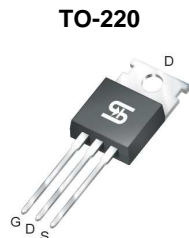

**Notes:** Moisture sensitivity level: level 3. Per J-STD-020

### ABSOLUTE MAXIMUM RATINGS ( $T_A = 25^\circ\text{C}$ unless otherwise noted)

PARAMETER	SYMBOL	LIMIT	UNIT
Drain-Source Voltage	$V_{DS}$	100	V
Gate-Source Voltage	$V_{GS}$	$\pm 20$	V
Continuous Drain Current <sup>(Note 1)</sup>	$I_D$	$T_C = 25^\circ\text{C}$	160
		$T_C = 70^\circ\text{C}$	127
		$T_A = 25^\circ\text{C}$	14.2
		$T_A = 70^\circ\text{C}$	11.4
Pulsed Drain Current <sup>(Note 2)</sup>	$I_{DM}$	620	A
Total Power Dissipation	$P_{DTOT}$	$T_C = 25^\circ\text{C}$	300
		$T_C = 70^\circ\text{C}$	210
		$T_A = 25^\circ\text{C}$	2.4
		$T_A = 70^\circ\text{C}$	1.68
Single Pulsed Avalanche Energy <sup>(Note 3)</sup>	$E_{AS}, E_{AR}$	400	mJ
Single Pulsed Avalanche Current <sup>(Note 3)</sup>	$I_{AS}, I_{AR}$	40	A
Operating Junction and Storage Temperature Range	$T_J, T_{STG}$	- 55 to +175	$^\circ\text{C}$

<b>THERMAL PERFORMANCE</b>			
<b>PARAMETER</b>	<b>SYMBOL</b>	<b>LIMIT</b>	<b>UNIT</b>
Junction to Case Thermal Resistance	$R_{\theta JC}$	0.5	$^{\circ}\text{C/W}$
Junction to Ambient Thermal Resistance	$R_{\theta JA}$	62.5	$^{\circ}\text{C/W}$

**Notes:**  $R_{\theta JA}$  is the sum of the junction-to-case and case-to-ambient thermal resistances. The case thermal reference is defined at the solder mounting surface of the drain pins.  $R_{\theta JA}$  is guaranteed by design while  $R_{\theta CA}$  is determined by the user's board design.  $R_{\theta JA}$  shown below for single device operation on FR-4 PCB in still air.

<b>ELECTRICAL SPECIFICATIONS</b> ( $T_A = 25^{\circ}\text{C}$ unless otherwise noted)						
<b>PARAMETER</b>	<b>CONDITIONS</b>	<b>SYMBOL</b>	<b>MIN</b>	<b>TYP</b>	<b>MAX</b>	<b>UNIT</b>
<b>Static</b> (Note 4)						
Drain-Source Breakdown Voltage	$V_{GS} = 0\text{V}, I_D = 250\mu\text{A}$	$BV_{DSS}$	100	--	--	V
Gate Threshold Voltage	$V_{DS} = V_{GS}, I_D = 250\mu\text{A}$	$V_{GS(TH)}$	2	3	4	V
Zero Gate Voltage Drain Current	$V_{DS} = 80\text{V}, V_{GS} = 0\text{V}$	$I_{DSS}$	--	--	1	$\mu\text{A}$
Gate Body Leakage	$V_{GS} = \pm 20\text{V}, V_{DS} = 0\text{V}$	$I_{GSS}$	--	--	$\pm 100$	nA
Drain-Source On-State Resistance	$V_{GS} = 10\text{V}, I_D = 30\text{A}$	$R_{DS(on)}$	--	4.5	5.5	$\text{m}\Omega$
<b>Dynamic</b> (Note 5)						
Total Gate Charge	$V_{DS} = 30\text{V}, I_D = 30\text{A}, V_{GS} = 10\text{V}$	$Q_g$	--	154	--	nC
Gate-Source Charge		$Q_{gs}$	--	35	--	
Gate-Drain Charge		$Q_{gd}$	--	40	--	
Input Capacitance	$V_{DS} = 30\text{V}, V_{GS} = 0\text{V}, F = 1.0\text{MHz}$	$C_{iss}$	--	9840	--	pF
Output Capacitance		$C_{oss}$	--	750	--	
Reverse Transfer Capacitance		$C_{rss}$	--	260	--	
<b>Switching</b> (Note 6)						
Turn-On Delay Time	$V_{GS} = 10\text{V}, V_{DS} = 30\text{V}, R_G = 3.3\Omega$	$t_{d(on)}$	--	25	--	ns
Turn-On Rise Time		$t_r$	--	40	--	
Turn-Off Delay Time		$t_{d(off)}$	--	85	--	
Turn-Off Fall Time		$t_f$	--	45	--	
<b>Source-Drain Diode</b> (Note 4)						
Forward Voltage	$V_{GS}=0\text{V}, I_S=30\text{A}$	$V_{SD}$	-	0.8	1.3	V
Reverse Recovery Time	$I_S = 30\text{A}, T_J = 25^{\circ}\text{C}$ $di/dt = 100\text{A}/\mu\text{s}$	$t_{rr}$		120		nS
Reverse Recovery Charge		$Q_{rr}$		160		nC

**Notes:**

1. Current limited by package.
2. Pulse width limited by the maximum junction temperature.
3.  $L = 0.5\text{mH}, I_{AS} = 40\text{A}, V_{DD} = 50\text{V}, R_G = 25\Omega$ , Starting  $T_J = 25^{\circ}\text{C}$
4. Pulse test:  $PW \leq 300\mu\text{s}$ , duty cycle  $\leq 2\%$ .
5. For DESIGN AID ONLY, not subject to production testing.
6. Switching time is essentially independent of operating temperature.

**ORDERING INFORMATION**

<b>PART NO.</b>	<b>PACKAGE</b>	<b>PACKING</b>
TSM160N10CZ C0G	TO-220	50pcs / Tube

**Note:**

1. Compliant to RoHS Directive 2011/65/EU and in accordance to WEEE 2002/96/EC
2. Halogen-free according to IEC 61249-2-21 definition

**CHARACTERISTICS CURVES**

( $T_A = 25^\circ\text{C}$  unless otherwise noted)

**Output Characteristics**

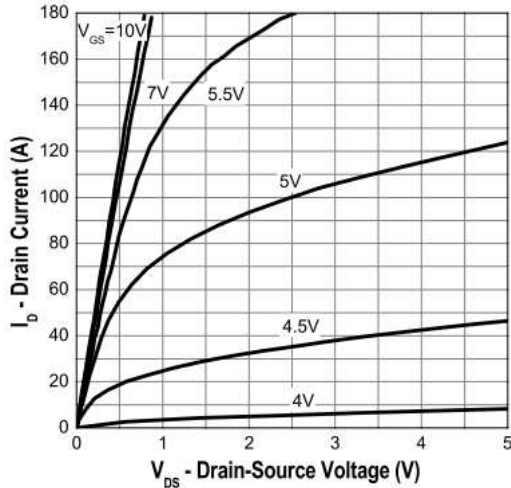

**Gate Threshold Voltage**

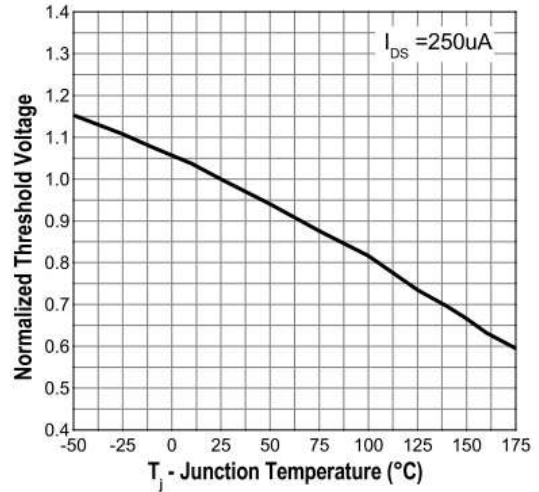

**Gate Source On Resistance**

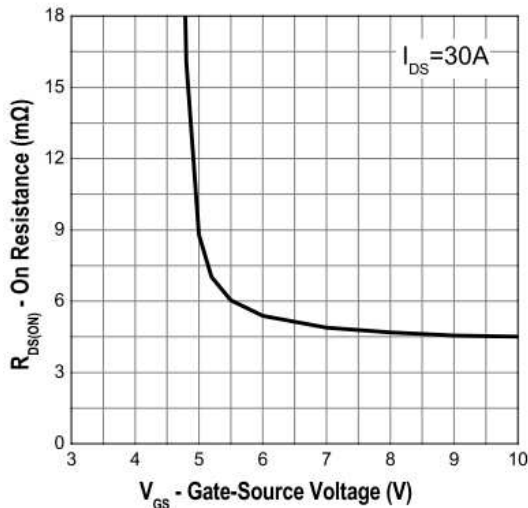

**Drain-Source On Resistance**

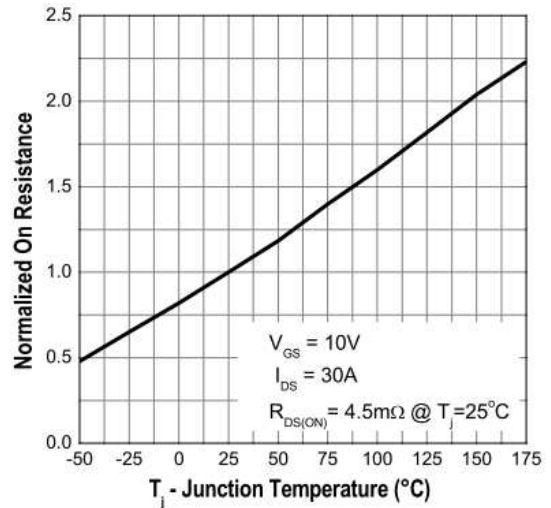

**Drain-Source On-Resistance**

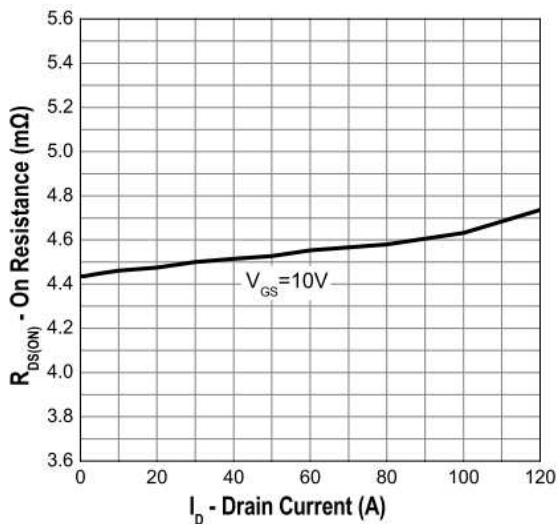

**Source-Drain Diode Forward Voltage**

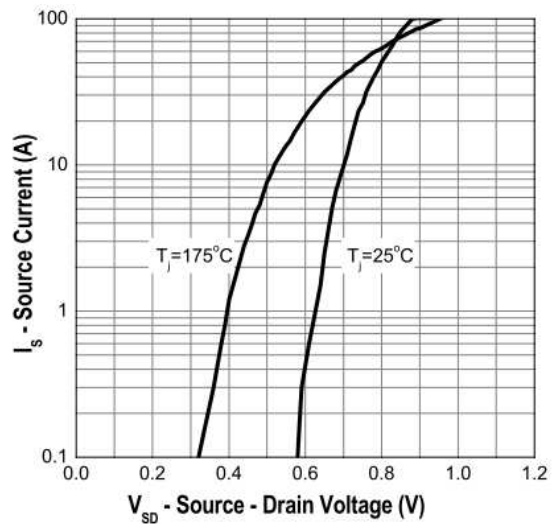

**CHARACTERISTICS CURVES**

( $T_A = 25^\circ\text{C}$  unless otherwise noted)

**Power Derating**

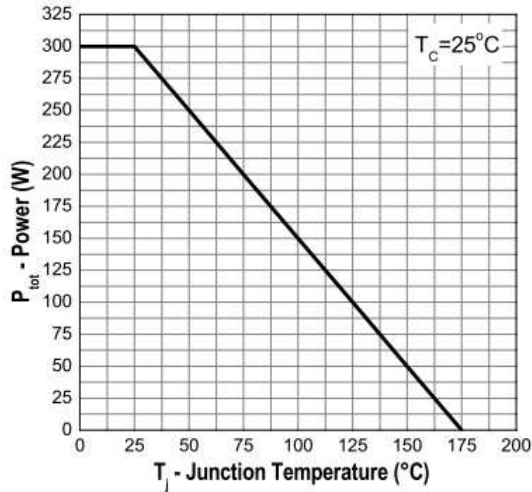

**Drain Current vs. Junction Temperature**

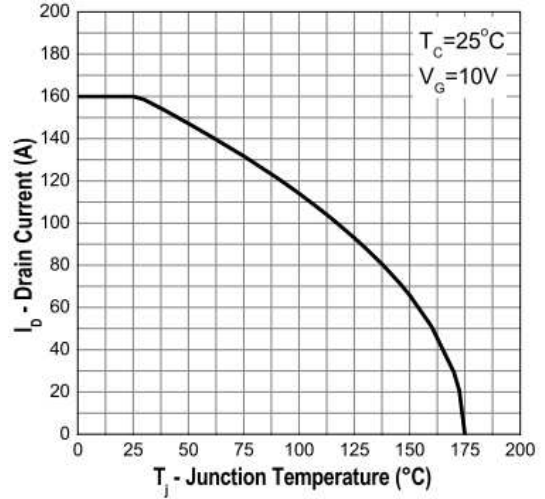

**Safe Operation Area**

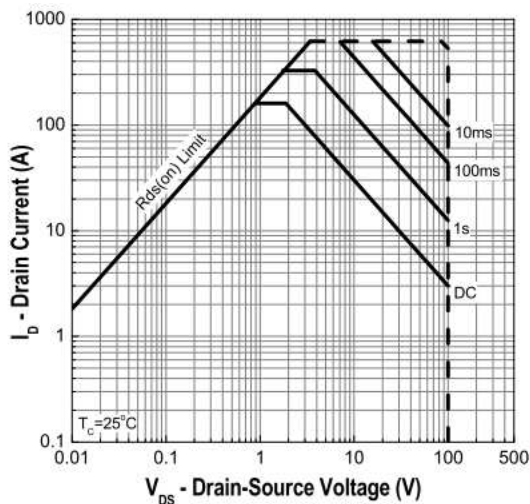

**Transient Thermal Impedance**

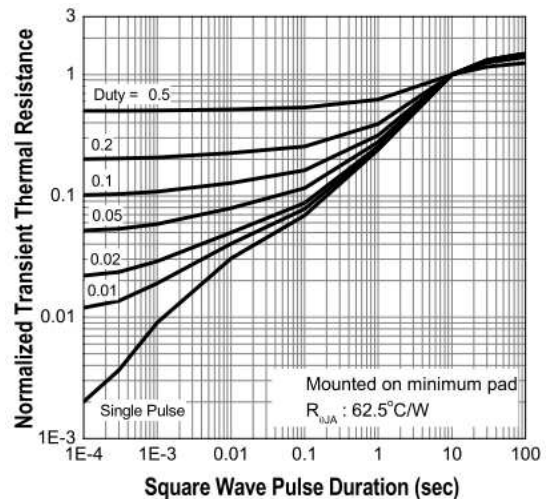

**Capacitance**

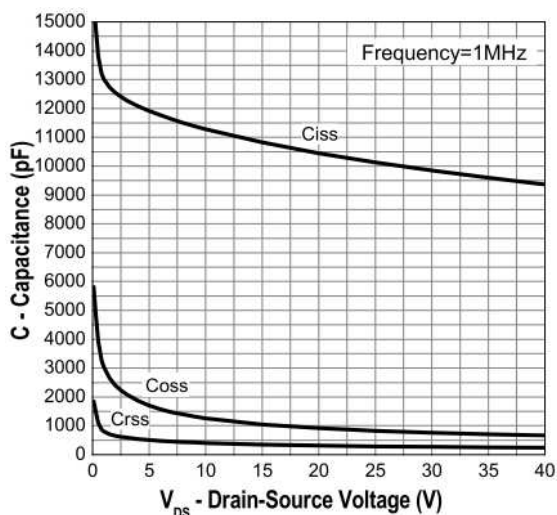

**Gate Charge**

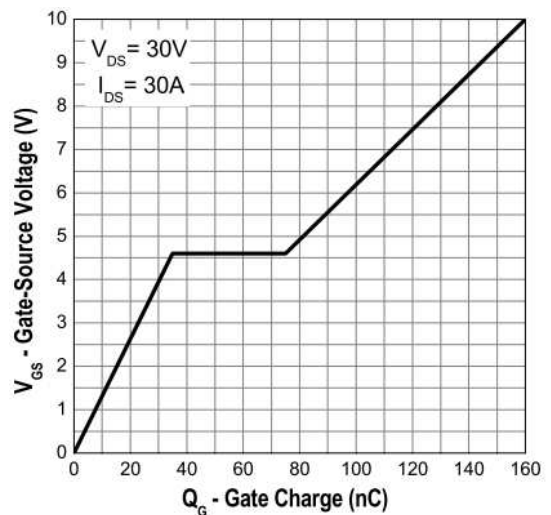

**PACKAGE OUTLINE DIMENSIONS** (Unit: Millimeters)

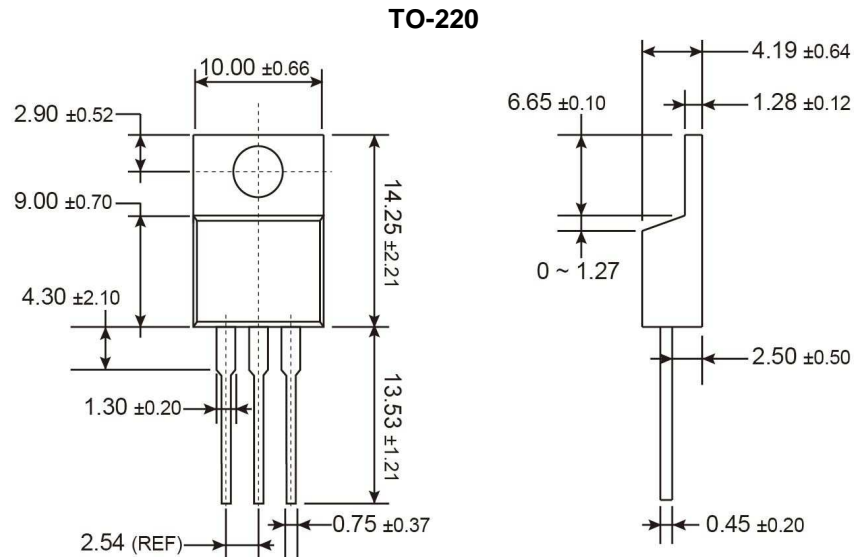

**Marking Diagram**

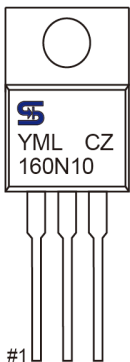

- Y** = Year Code
- M** = Month Code for Halogen Free Product
  - O** =Jan    **P** =Feb    **Q** =Mar    **R** =Apr
  - S** =May    **T** =Jun    **U** =Jul    **V** =Aug
  - W** =Sep    **X** =Oct    **Y** =Nov    **Z** =Dec
- L** = Lot Code (1~9, A~Z)

## Notice

Specifications of the products displayed herein are subject to change without notice. TSC or anyone on its behalf, assumes no responsibility or liability for any errors or inaccuracies.

Information contained herein is intended to provide a product description only. No license, express or implied, to any intellectual property rights is granted by this document. Except as provided in TSC's terms and conditions of sale for such products, TSC assumes no liability whatsoever, and disclaims any express or implied warranty, relating to sale and/or use of TSC products including liability or warranties relating to fitness for a particular purpose, merchantability, or infringement of any patent, copyright, or other intellectual property right.

The products shown herein are not designed for use in medical, life-saving, or life-sustaining applications. Customers using or selling these products for use in such applications do so at their own risk and agree to fully indemnify TSC for any damages resulting from such improper use or sale.

## Looking for pricing, stock, or lifecycle information?

Click below to explore more details on WIN SOURCE:

- ⊖ [View TSM160N10CZ COG on WIN SOURCE](#)
- ⊖ [Taiwan Semiconductor](#) Information

## Optimize Your Supply Chain with WIN SOURCE Solutions

- ✓ Global Sourcing Solution
- ✓ Obsolete Management
- ✓ Cost Control Management
- ✓ Shortage Management
- ✓ Alternative Solution
- ✓ Excess Inventory Management