



**THE DATASHEET OF  
LMH6657MFX/NOPB**



## LMH6657 and LMH6658 270-MHz Single Supply, Single and Dual Amplifiers

### 1 Features

$V_S = 5\text{ V}$ ,  $T_A = 25^\circ\text{C}$ ,  $R_L = 100\ \Omega$  (Typical Values Unless Specified)

- -3dB BW ( $A_V = +1$ ) 270 MHz
- Supply Voltage Range 3 V to 12 V
- Slew Rate, ( $V_S = \pm 5\text{ V}$ ) 700 V/ $\mu\text{s}$
- Supply Current 6.2 mA/amp
- Output Current +80/-90 mA
- Input Common-Mode Volt. 0.5 V Beyond  $V^-$ , 1.7 V from  $V^+$
- Output Voltage Swing ( $R_L = 2\text{ k}\Omega$ ) 0.8 V from Rails
- Input Voltage Noise 11 nV/ $\sqrt{\text{Hz}}$
- Input Current Noise 2.1 pA/ $\sqrt{\text{Hz}}$
- DG Error 0.03%
- DP Error 0.10°
- THD (5MHz) -55 dBc
- Settling Time (0.1%) 37ns
- Fully Characterized for 5 V, and  $\pm 5\text{ V}$
- Output Overdrive Recovery 18 ns
- Output Short Circuit Protected<sup>(1)</sup>
- No Output Phase Reversal With CMVR Exceeded

### 2 Applications

- CD/DVD ROM
- ADC Buffer Amps
- Portable Video
- Current Sense Buffers
- Portable Communications

(1) Short Circuit Test is a momentary test. See Note 3 under [Absolute Maximum Ratings](#).

### 3 Description

The LMH6657 and LMH6658 devices are low-cost operational amplifiers that operate from a single supply with input voltage range extending below the  $V^-$ . Based on easy to use voltage feedback topology and boasting fast slew rate (700 V/ $\mu\text{s}$ ) and high speed (140 MHz GBWP), the LMH6657 (Single) and LMH6658 (dual) can be used in high speed large signal applications. These applications include instrumentation, communication devices, set-top boxes, and so forth.

With a -3dB BW of 100 MHz ( $A_V = +2$ ) and DG & DP of 0.03% & 0.10° respectively, the LMH6657 and LMH6658 are well suited for video applications. The output stage can typically supply 80 mA into the load with a swing of about 1 V from either rail.

For Industrial applications, the LMH6657 and LMH6658 are excellent cost-saving choices. Input referred voltage noise is low and the input voltage can extend below  $V^-$  to ease amplification of low level signals that could be at or near the system ground. With low distortion and fast settling, LMH6657 and LMH6658 can provide buffering for A/D and D/A applications.

The LMH6657 and LMH6658 versatility and ease of use is extended even further by offering these high slew rate, high-speed operational amplifiers in miniature packages such as SOT-23-5, SC70, SOIC-8, and VSSOP-8.

#### Device Information<sup>(1)</sup>

| PART NUMBER | PACKAGE    | BODY SIZE (NOM)   |
|-------------|------------|-------------------|
| LMH6657     | SC70 (5)   | 2.00 mm x 1.25 mm |
|             | SOT-23 (5) | 2.90 mm x 1.60 mm |
| LMH6658     | SOIC (8)   | 4.90 mm x 3.91 mm |
|             | VSSOP (8)  | 3.00 mm x 3.00 mm |

(1) For all available packages, see the orderable addendum at the end of the data sheet.

#### Noninverting Frequency Response, Gain

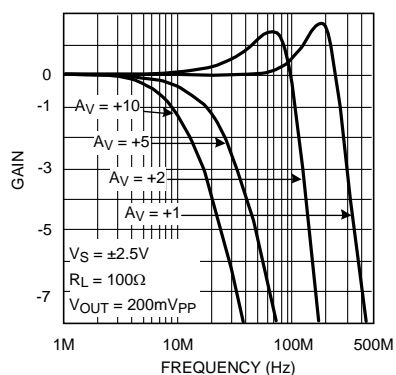

#### Noninverting Frequency Response, Phase

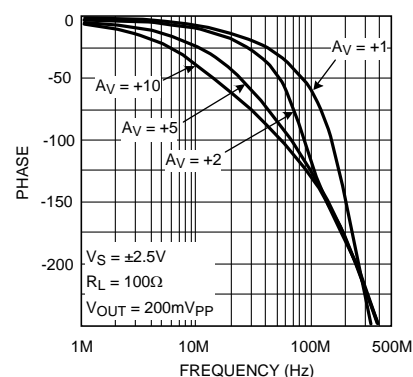

## Table of Contents

|   |           |  |           |
|---|-----------|--|-----------|
| <b>1 Features</b> .....                         | <b>1</b>  | 7.3 Device Functional Modes.....                 | <b>18</b> |
| <b>2 Applications</b> .....                     | <b>1</b>  | <b>8 Application and Implementation</b> .....    | <b>19</b> |
| <b>3 Description</b> .....                      | <b>1</b>  | 8.1 Application Information.....                 | <b>19</b> |
| <b>4 Revision History</b> .....                 | <b>2</b>  | <b>9 Power Supply Recommendations</b> .....      | <b>20</b> |
| <b>5 Pin Configuration and Functions</b> .....  | <b>3</b>  | <b>10 Layout</b> .....                           | <b>20</b> |
| <b>6 Specifications</b> .....                   | <b>4</b>  | 10.1 Layout Guidelines .....                     | <b>20</b> |
| 6.1 Absolute Maximum Ratings .....              | <b>4</b>  | 10.2 Layout Example .....                        | <b>21</b> |
| 6.2 ESD Ratings.....                            | <b>4</b>  | <b>11 Device and Documentation Support</b> ..... | <b>23</b> |
| 6.3 Recommended Operating Conditions.....       | <b>4</b>  | 11.1 Documentation Support .....                 | <b>23</b> |
| 6.4 Thermal Information .....                   | <b>4</b>  | 11.2 Related Links .....                         | <b>23</b> |
| 6.5 Electrical Characteristics, 5 V .....       | <b>5</b>  | 11.3 Community Resources.....                    | <b>23</b> |
| 6.6 Electrical Characteristics, $\pm 5$ V ..... | <b>7</b>  | 11.4 Trademarks .....                            | <b>23</b> |
| 6.7 Typical Characteristics .....               | <b>9</b>  | 11.5 Electrostatic Discharge Caution.....        | <b>23</b> |
| <b>7 Detailed Description</b> .....             | <b>17</b> | 11.6 Glossary .....                              | <b>23</b> |
| 7.1 Overview .....                              | <b>17</b> | <b>12 Mechanical, Packaging, and Orderable</b>   |           |
| 7.2 Feature Description.....                    | <b>17</b> | <b>Information</b> .....                         | <b>23</b> |

## 4 Revision History

NOTE: Page numbers for previous revisions may differ from page numbers in the current version.

### Changes from Revision F (April 2013) to Revision G

Page

- Added *Pin Configuration and Functions* section, *ESD Ratings* table, *Feature Description* section, *Device Functional Modes*, *Application and Implementation* section, *Power Supply Recommendations* section, *Layout* section, *Device and Documentation Support* section, and *Mechanical, Packaging, and Orderable Information* section ..... **1**

### Changes from Revision E (March 2013) to Revision F

Page

- Changed layout of National Data Sheet to TI format ..... **1**

## 5 Pin Configuration and Functions

**DBV and DCK Package  
5-Pin SOT-23 and SC70  
Top View**

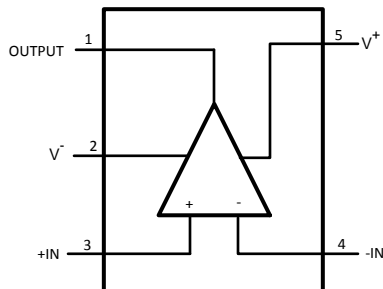

**D and DGK Package  
8-Pin SOIC and VSSOP  
Top View**

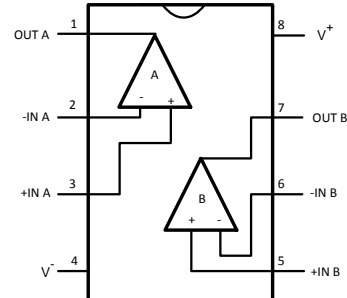

### Pin Functions

| NAME           | PIN NO.         |                | I/O | DESCRIPTION                  |
|----------------|-----------------|----------------|-----|------------------------------|
|                | SOT-23 AND SC70 | SOIC AND VSSOP |     |                              |
| OUTPUT         | 1               | —              | O   | Output                       |
| -IN            | 4               | —              | I   | Inverting input              |
| +IN            | 3               | —              | I   | Noninverting input           |
| OUT A          | —               | 1              | O   | Output A                     |
| -IN A          | —               | 2              | I   | Inverting input A            |
| +IN A          | —               | 3              | I   | Noninverting input A         |
| V <sup>-</sup> | 2               | 4              | I   | Negative Supply              |
| OUT B          | —               | 7              | O   | Output B                     |
| -IN B          | —               | 6              | I   | Inverting input channel B    |
| +IN B          | —               | 5              | I   | Noninverting input channel B |
| V <sup>+</sup> | 5               | 8              | I   | Positive supply              |

## 6 Specifications

### 6.1 Absolute Maximum Ratings

 over operating free-air temperature range (unless otherwise noted)<sup>(1)</sup>

|   | MIN                              | MAX                   | UNIT |
|---|----------------------------------|-----------------------|------|
| V <sub>IN</sub> Differential                      |                                  | ±2.5                  | V    |
| Output Short Circuit Duration                     |                                  | See <sup>(2)(3)</sup> |      |
| Input Current                                     |                                  | ±10                   | mA   |
| Supply Voltage (V <sup>+</sup> - V <sup>-</sup> ) |                                  | 12.6                  | V    |
| Voltage at Input/Output pins                      | V <sup>-</sup> - 0.8             | V <sup>+</sup> + 0.8  | V    |
| Soldering Information                             | Infrared or Convection (20 sec.) | 260                   | °C   |
|   | Wave Soldering (10 sec.)         | 260                   |      |
| Storage temperature, T <sub>stg</sub>             | -65                              | 100                   | °C   |
| Junction Temperature <sup>(4)</sup>               |                                  | 150                   | °C   |

- (1) Stresses beyond those listed under *Absolute Maximum Ratings* may cause permanent damage to the device. These are stress ratings only, which do not imply functional operation of the device at these or any other conditions beyond those indicated under *Recommended Operating Conditions*. Exposure to absolute-maximum-rated conditions for extended periods may affect device reliability.
- (2) Applies to both single-supply and split-supply operation. Continuous short circuit operation at elevated ambient temperature can result in exceeding the maximum allowed junction temperature of 150°C.
- (3) Output short circuit duration is infinite for V<sub>S</sub> < 6 V at room temperature and below. For V<sub>S</sub> > 6 V, allowable short circuit duration is 1.5ms.
- (4) The maximum power dissipation is a function of T<sub>J(MAX)</sub>, R<sub>θJA</sub>, and T<sub>A</sub>. The maximum allowable power dissipation at any ambient temperature is P<sub>D</sub> = (T<sub>J(MAX)</sub> - T<sub>A</sub>) / R<sub>θJA</sub>. All numbers apply for packages soldered directly onto a PCB.

### 6.2 ESD Ratings

|  | VALUE  | UNIT  |
|--|--|-------|
| V <sub>(ESD)</sub> Electrostatic discharge | Human body model (HBM), per ANSI/ESDA/JEDEC JS-001 <sup>(1)(2)</sup> | ±2000 |
|  | Machine Model <sup>(3)</sup>   | ±200  |

- (1) JEDEC document JEP155 states that 500-V HBM allows safe manufacturing with a standard ESD control process. Manufacturing with less than 500-V HBM is possible with the necessary precautions. Pins listed as ±2000 V may actually have higher performance.
- (2) Human body model, 1.5 kΩ in series with 100 pF.
- (3) Machine Model, 0 Ω in series with 200 pF.

### 6.3 Recommended Operating Conditions

over operating free-air temperature range (unless otherwise noted)

|   | MIN | MAX | UNIT |
|---|-----|-----|------|
| Supply Voltage (V <sup>+</sup> - V <sup>-</sup> ) | 3   | 12  | V    |
| Operating Temperature <sup>(1)</sup>              | -40 | 85  | °C   |

- (1) The maximum power dissipation is a function of T<sub>J(MAX)</sub>, R<sub>θJA</sub>, and T<sub>A</sub>. The maximum allowable power dissipation at any ambient temperature is P<sub>D</sub> = (T<sub>J(MAX)</sub> - T<sub>A</sub>) / R<sub>θJA</sub>. All numbers apply for packages soldered directly onto a PCB.

### 6.4 Thermal Information

| THERMAL METRIC <sup>(1)</sup>  | LMH6657      |            | LMH6658  |             | UNIT |
|--|--------------|------------|----------|-------------|------|
|  | DBV (SOT-23) | DCK (SC70) | D (SOIC) | DGK (VSSOP) |      |
|  | 5 PINS       |            | 8 PINS   |             |      |
| R <sub>θJA</sub> Junction-to-ambient thermal resistance <sup>(2)</sup> | 265          | 478        | 190      | 235         | °C/W |

- (1) For more information about traditional and new thermal metrics, see the *Semiconductor and IC Package Thermal Metrics* application report, [SPRA953](#).
- (2) The maximum power dissipation is a function of T<sub>J(MAX)</sub>, R<sub>θJA</sub>, and T<sub>A</sub>. The maximum allowable power dissipation at any ambient temperature is P<sub>D</sub> = (T<sub>J(MAX)</sub> - T<sub>A</sub>) / R<sub>θJA</sub>. All numbers apply for packages soldered directly onto a PCB.

## 6.5 Electrical Characteristics, 5 V

Unless otherwise specified, all limits ensured for at  $T_J = 25^\circ\text{C}$ ,  $V^+ = 5\text{ V}$ ,  $V^- = 0\text{ V}$ ,  $V_{\text{CM}} = V_O = V^+/2$ , and  $R_L = 100\Omega$  (or as specified) tied to  $V^+/2$ .

| PARAMETER                            |                                     | TEST CONDITIONS  | MIN <sup>(1)</sup> | TYP <sup>(2)</sup> | MAX <sup>(1)</sup> | UNIT                   |
|--------------------------------------|-------------------------------------|--|--------------------|--------------------|--------------------|------------------------|
| GB                                   | Gain Bandwidth Product              | $V_{\text{OUT}} < 200\text{ mV}_{\text{PP}}$   |                    | 140                |                    | MHz                    |
| SSBW                                 | -3-dB BW                            | $A_V = +1$ , $V_{\text{OUT}} = 200\text{ mV}_{\text{PP}}$                                | 220                | 270                |                    | MHz                    |
|                                      |                                     | $A_V = +2$ or $-1$ , $V_{\text{OUT}} = 200\text{ mV}_{\text{PP}}$                        |                    | 100                |                    |                        |
| GFP                                  | Frequency Response Peaking          | $A_V = +2$ , $V_{\text{OUT}} = 200\text{ mV}_{\text{PP}}$ ,<br>DC to 100 MHz             |                    | 1.5                |                    | dB                     |
| GFR                                  | Frequency Response Rolloff          | $A_V = +2$ , $V_{\text{OUT}} = 200\text{ mV}_{\text{PP}}$ ,<br>DC to 100 MHz             |                    | 0.5                |                    | dB                     |
| LPD <sub>1°</sub>                    | 1° Linear Phase Deviation           | $A_V = +2$ , $V_{\text{OUT}} = 200\text{ mV}_{\text{PP}}$ , $\pm 1^\circ$                |                    | 30                 |                    | MHz                    |
| GF <sub>0.1dB</sub>                  | 0.1-dB Gain Flatness                | $A_V = +2$ , $\pm 0.1\text{ dB}$ , $V_{\text{OUT}} = 200\text{ mV}_{\text{PP}}$          |                    | 13                 |                    | MHz                    |
| PBW                                  | Full Power Bandwidth                | -1 dB, $V_{\text{OUT}} = 3\text{ V}_{\text{PP}}$ , $A_V = -1$                            |                    | 55                 |                    | MHz                    |
| DG                                   | Differential Gain                   | NTSC, $V_{\text{CM}} = 2\text{ V}$ , $R_L = 150\Omega$ to $V^+/2$ , Pos. Video Only      |                    | 0.03%              |                    |                        |
| DP                                   | Differential Phase                  | NTSC, $V_{\text{CM}} = 2\text{ V}$ , $R_L = 150\Omega$ to $V^+/2$ Pos. Video Only        |                    | 0.1                |                    | deg                    |
| <b>TIME DOMAIN RESPONSE</b>          |                                     |  |                    |                    |                    |                        |
| $t_r$                                | Rise and Fall Time                  | $A_V = +2$ , $V_{\text{OUT}} = 500\text{ mV}_{\text{PP}}$                                |                    | 3.3                |                    | ns                     |
|                                      |                                     | $A_V = -1$ , $V_{\text{OUT}} = 500\text{ mV}_{\text{PP}}$                                |                    | 3.4                |                    |                        |
| OS                                   | Overshoot, Undershoot               | $A_V = +2$ , $V_{\text{OUT}} = 500\text{ mV}_{\text{PP}}$                                |                    | 18%                |                    |                        |
| $t_s$                                | Settling Time                       | $V_O = 2\text{ V}_{\text{PP}}$ , $\pm 0.1\%$ , $R_L = 500\Omega$ to $V^+/2$ , $A_V = -1$ |                    | 37                 |                    | ns                     |
| SR                                   | Slew Rate <sup>(3)</sup>            | $A_V = -1$ , $V_O = 3\text{V}_{\text{PP}}$ <sup>(4)</sup>                                |                    | 470                |                    | V/ $\mu\text{s}$       |
|                                      |                                     | $A_V = +2$ , $V_O = 3\text{V}_{\text{PP}}$ <sup>(4)</sup>                                |                    | 420                |                    |                        |
| <b>DISTORTION AND NOISE RESPONSE</b> |                                     |  |                    |                    |                    |                        |
| HD2                                  | 2 <sup>nd</sup> Harmonic Distortion | $f = 5\text{MHz}$ , $V_O = 2\text{V}_{\text{PP}}$ , $A_V = -1$                           |                    | -70                |                    | dBc                    |
| HD3                                  | 3 <sup>rd</sup> Harmonic Distortion | $f = 5\text{MHz}$ , $V_O = 2\text{V}_{\text{PP}}$ , $A_V = -1$                           |                    | -57                |                    | dBc                    |
| THD                                  | Total Harmonic Distortion           | $f = 5\text{MHz}$ , $V_O = 2\text{V}_{\text{PP}}$ , $A_V = -1$                           |                    | -55.5              |                    | dBc                    |
| $V_n$                                | Input-Referred Voltage Noise        | $f = 100\text{KHz}$  |                    | 11                 |                    | nV/ $\sqrt{\text{Hz}}$ |
|                                      |                                     | $f = 1\text{KHz}$  |                    | 19                 |                    |                        |
| $I_n$                                | Input-Referred Current Noise        | $f = 100\text{KHz}$  |                    | 2.1                |                    | pA/ $\sqrt{\text{Hz}}$ |
|                                      |                                     | $f = 1\text{KHz}$  |                    | 7.5                |                    |                        |
| XTLKA                                | Cross-Talk Rejection (LMH6658)      | $f = 5\text{MHz}$ , $R_L$ (SND) = 100 $\Omega$<br>RCV: $R_F = R_G = 1\text{k}$           |                    | 69                 |                    | dB                     |
| <b>STATIC, DC PERFORMANCE</b>        |                                     |  |                    |                    |                    |                        |
| $A_{\text{VOL}}$                     | Large Signal Voltage Gain           | $V_O = 1.25\text{V}$ to $3.75\text{V}$ ,<br>$R_L = 2\text{k}$ to $V^+/2$                 | 85                 | 95                 |                    | dB                     |
|                                      |                                     | $V_O = 1.5\text{V}$ to $3.5\text{V}$ ,<br>$R_L = 150\Omega$ to $V^+/2$                   | 75                 | 85                 |                    |                        |
|                                      |                                     | $V_O = 2\text{V}$ to $3\text{V}$ ,<br>$R_L = 50\Omega$ to $V^+/2$                        | 70                 | 80                 |                    |                        |
| CMVR                                 | Input Common-Mode Voltage Range     | CMRR $\geq 50\text{dB}$  | -0.2               | -0.5               |                    | V                      |
|                                      |                                     | At the temperature extremes  | -0.1               |                    |                    |                        |
|                                      |                                     |  | 3                  | 3.3                |                    |                        |
|                                      |                                     | At the temperature extremes  | 2.8                |                    |                    |                        |
| $V_{\text{OS}}$                      | Input Offset Voltage                |  |                    | $\pm 1.1$          | $\pm 5$            | mV                     |
|                                      |                                     | At the temperature extremes  |                    |                    | $\pm 7$            |                        |
| TC $V_{\text{OS}}$                   | Input Offset Voltage Average Drift  | See <sup>(5)</sup>   |                    | $\pm 2$            |                    | $\mu\text{V}/\text{C}$ |

(1) All limits are ensured by testing or statistical analysis.

(2) Typical values represent the most likely parametric norm.

(3) Slew rate is the "worst case" of the rising and falling slew rates.

(4) Output Swing not limited by Slew Rate limit.

(5) Drift determined by dividing the change in parameter at temperature extremes by the total temperature change.

**Electrical Characteristics, 5 V (continued)**

Unless otherwise specified, all limits ensured for at  $T_J = 25^\circ\text{C}$ ,  $V^+ = 5\text{ V}$ ,  $V^- = 0\text{ V}$ ,  $V_{\text{CM}} = V_O = V^+/2$ , and  $R_L = 100\Omega$  (or as specified) tied to  $V^+/2$ .

| PARAMETER                        |   | TEST CONDITIONS  | MIN <sup>(1)</sup>          | TYP <sup>(2)</sup>          | MAX <sup>(1)</sup> | UNIT                       |
|----------------------------------|---|--|-----------------------------|-----------------------------|--------------------|----------------------------|
| $I_B$                            | Input Bias Current                          | See <sup>(6)</sup>   |                             | -5                          | -20                | $\mu\text{A}$              |
|                                  |   |  | At the temperature extremes |                             | -30                |                            |
| $TC_{I_B}$                       | Input Bias Current Average Drift            | See <sup>(5)</sup>   |                             | 0.01                        |                    | $\text{nA}/^\circ\text{C}$ |
| $I_{OS}$                         | Input Offset Current                        |  |                             | 50                          | 300                | $\text{nA}$                |
|                                  |   |  | At the temperature extremes |                             | 500                |                            |
| CMRR                             | Common-Mode Rejection Ratio                 | $V_{\text{CM}}$ Stepped from 0V to 3.0V                            | 72                          | 82                          |                    | dB                         |
| +PSRR                            | Positive Power Supply Rejection Ratio       | $V^+ = 4.5\text{V}$ to $5.5\text{V}$ , $V_{\text{CM}} = 1\text{V}$ | 72                          | 82                          |                    | dB                         |
| $I_S$                            | Supply Current (per channel)                | No load  |                             | 6.2                         | 8.5                | $\text{mA}$                |
|                                  |   |  | At the temperature extremes |                             | 10                 |                            |
| <b>MISCELLANEOUS PERFORMANCE</b> |   |  |                             |                             |                    |                            |
| $V_{OH}$                         | Output Swing High                           | $R_L = 2\text{k}$ to $V^+/2$                                       |                             | 4.1                         | 4.25               | $\text{V}$                 |
|                                  |   |  | At the temperature extremes | 3.8                         |                    |                            |
|                                  |   | $R_L = 150\Omega$ to $V^+/2$                                       |                             | 4                           | 4.19               |                            |
|                                  |   |  | At the temperature extremes | 3.7                         |                    |                            |
| $V_{OL}$                         | Output Swing Low                            | $R_L = 75\Omega$ to $V^+/2$  |                             | 3.85                        | 4.15               | $\text{mV}$                |
|                                  |   |  | At the temperature extremes | 3.5                         |                    |                            |
|                                  |   | $R_L = 2\text{k}$ to $V^+/2$                                       |                             | 900                         | 800                |                            |
|                                  |   |  | At the temperature extremes | 1100                        |                    |                            |
| $I_{OUT}$                        | Output Current                              | $R_L = 150\Omega$ to $V^+/2$                                       |                             | 970                         | 870                | $\text{mA}$                |
|                                  |   |  | At the temperature extremes | 1200                        |                    |                            |
|                                  |   | $R_L = 75\Omega$ to $V^+/2$  |                             | 990                         | 885                |                            |
|                                  |   |  | At the temperature extremes | 1250                        |                    |                            |
| $I_{OUT}$                        | Output Current                              | $V_{\text{OUT}} = 1\text{V}$ from either rail                      | Sourcing                    | 40                          | 85                 | $\text{mA}$                |
|                                  |   |  | Sinking                     | -40                         | 105                |                            |
| $I_{SC}$                         | Output Short Circuit Current <sup>(7)</sup> | Sourcing to $V^+/2$  |                             | 100                         | 155                | $\text{mA}$                |
|                                  |   |  |                             | At the temperature extremes | 80                 |                            |
|                                  |   | Sinking to $V^+/2$   |                             | 100                         | 220                |                            |
|                                  |   |  |                             | At the temperature extremes | 80                 |                            |
| $R_{IN}$                         | Common-Mode Input Resistance                |  | 3                           |                             | $\text{M}\Omega$   |                            |
| $C_{IN}$                         | Common-Mode Input Capacitance               |  | 1.8                         |                             | $\text{pF}$        |                            |
| $R_{OUT}$                        | Output Impedance                            | $f = 1\text{MHz}$ , $A_V = +1$                                     |                             | 0.06                        |                    | $\Omega$                   |

(6) Positive current corresponds to current flowing into the device.

(7) Short circuit test is a momentary test. See [Note 3](#) under *Absolute Maximum Ratings*.

## 6.6 Electrical Characteristics, $\pm 5$ V

Unless otherwise specified, all limits ensured for at  $T_J = 25^\circ\text{C}$ ,  $V^+ = 5$  V,  $V^- = -5$  V,  $V_{CM} = V_O$ , and  $R_L = 100\ \Omega$  (or as specified) tied to 0 V.

| PARAMETER                            |                                     | TEST CONDITIONS  | MIN <sup>(1)</sup>          | TYP <sup>(2)</sup> | MAX <sup>(1)</sup> | UNIT                   |
|--------------------------------------|-------------------------------------|--|-----------------------------|--------------------|--------------------|------------------------|
| GB                                   | Gain Bandwidth Product              | $V_{OUT} < 200\ \text{mV}_{PP}$  |                             | 140                |                    | MHz                    |
| SSBW                                 | -3-dB BW                            | $A_V = +1$ , $V_{OUT} = 200\ \text{mV}_{PP}$                                       | 220                         | 270                |                    | MHz                    |
|                                      |                                     | $A_V = +2$ or $-1$ , $V_{OUT} = 200\ \text{mV}_{PP}$                               |                             | 100                |                    |                        |
| GFP                                  | Frequency Response Peaking          | $A_V = +2$ , $V_{OUT} = 200\ \text{mV}_{PP}$ ,<br>DC to 100 MHz                    |                             | 1                  |                    | dB                     |
| GFR                                  | Frequency Response Roll-off         | $A_V = +2$ , $V_{OUT} = 200\ \text{mV}_{PP}$ ,<br>DC to 100 MHz                    |                             | 0.9                |                    | dB                     |
| LPD <sub>1°</sub>                    | 1° Linear Phase Deviation           | $A_V = +2$ , $V_{OUT} = 200\ \text{mV}_{PP}$ , $\pm 1^\circ$                       |                             | 30                 |                    | MHz                    |
| GF <sub>0.1dB</sub>                  | 0.1-dB Gain Flatness                | $A_V = +2$ , $\pm 0.1\ \text{dB}$ , $V_{OUT} = 200\ \text{mV}_{PP}$                |                             | 20                 |                    | MHz                    |
| PBW                                  | Full Power Bandwidth                | -1 dB, $V_{OUT} = 8\ V_{PP}$ , $A_V = -1$  |                             | 30                 |                    | MHz                    |
| DG                                   | Differential Gain                   | NTSC, $R_L = 150\ \Omega$ , Pos. or Neg. Video                                     |                             | 0.03%              |                    |                        |
| DP                                   | Differential Phase                  | NTSC, $R_L = 150\ \Omega$ , Pos. or Neg. Video                                     |                             | 0.1                |                    | deg                    |
| <b>TIME DOMAIN RESPONSE</b>          |                                     |  |                             |                    |                    |                        |
| $t_r$                                | Rise and Fall Time                  | $A_V = +2$ , $V_{OUT} = 500\ \text{mV}_{PP}$                                       |                             | 3.3                |                    | ns                     |
|                                      |                                     | $A_V = -1$ , $V_{OUT} = 500\ \text{mV}_{PP}$                                       |                             | 3.3                |                    |                        |
| OS                                   | Overshoot, Undershoot               | $A_V = +2$ , $V_{OUT} = 500\ \text{mV}_{PP}$                                       |                             | 16%                |                    |                        |
| $t_s$                                | Settling Time                       | $V_O = 5\ V_{PP}$ , $\pm 0.1\%$ , $R_L = 500\ \Omega$ ,<br>$A_V = -1$              |                             | 35                 |                    | ns                     |
| SR                                   | Slew Rate <sup>(3)</sup>            | $A_V = -1$ , $V_O = 8\ V_{PP}$   |                             | 700                |                    | V/ $\mu$ s             |
|                                      |                                     | $A_V = +2$ , $V_O = 8\ V_{PP}$   |                             | 500                |                    |                        |
| <b>DISTORTION AND NOISE RESPONSE</b> |                                     |  |                             |                    |                    |                        |
| HD <sub>2</sub>                      | 2 <sup>nd</sup> Harmonic Distortion | $f = 5\ \text{MHz}$ , $V_O = 2\ V_{PP}$ , $A_V = -1$                               |                             | -70                |                    | dBc                    |
| HD <sub>3</sub>                      | 3 <sup>rd</sup> Harmonic Distortion | $f = 5\ \text{MHz}$ , $V_O = 2\ V_{PP}$ , $A_V = -1$                               |                             | -57                |                    | dBc                    |
| THD                                  | Total Harmonic Distortion           | $f = 5\ \text{MHz}$ , $V_O = 2\ V_{PP}$ , $A_V = -1$                               |                             | -55.5              |                    | dBc                    |
| $V_n$                                | Input-Referred Voltage Noise        | $f = 100\ \text{KHz}$  |                             | 11                 |                    | nV/ $\sqrt{\text{Hz}}$ |
|                                      |                                     | $f = 1\ \text{KHz}$  |                             | 19                 |                    |                        |
| $I_n$                                | Input-Referred Current Noise        | $f = 100\ \text{KHz}$  |                             | 2.1                |                    | pA/ $\sqrt{\text{Hz}}$ |
|                                      |                                     | $f = 1\ \text{KHz}$  |                             | 7.5                |                    |                        |
| XTLKA                                | Cross-Talk Rejection (LMH6658)      | $f = 5\ \text{MHz}$ , $R_L$ (SND) = 100 $\Omega$<br>RCV: $R_F = R_G = 1\ \text{k}$ |                             | 69                 |                    | dB                     |
| <b>STATIC, DC PERFORMANCE</b>        |                                     |  |                             |                    |                    |                        |
| $A_{VOL}$                            | Large Signal Voltage Gain           | $V_O = -3.75\ \text{V}$ to $3.75\ \text{V}$ , $R_L = 2\ \text{k}$                  | 87                          | 100                |                    | dB                     |
|                                      |                                     | $V_O = -3.5\ \text{V}$ to $3.5\ \text{V}$ , $R_L = 150\ \Omega$                    | 80                          | 90                 |                    |                        |
|                                      |                                     | $V_O = -3\ \text{V}$ to $3\ \text{V}$ , $R_L = 50\ \Omega$                         | 75                          | 85                 |                    |                        |
| CMVR                                 | Input Common-Mode Voltage Range     | CMRR $\geq 50\ \text{dB}$  |                             | -5.2               | -5.5               | V                      |
|                                      |                                     |  | At the temperature extremes | -5.1               |                    |                        |
|                                      |                                     |  |                             | 3                  | 3.3                |                        |
|                                      |                                     |  | At the temperature extremes | 2.8                |                    |                        |
| $V_{OS}$                             | Input Offset Voltage                | Apply at the temperature extremes  |                             | $\pm 1$            | $\pm 5$            | mV                     |
|                                      |                                     |  |                             | $\pm 7$            |                    |                        |
| TC $V_{OS}$                          | Input Offset Voltage Average Drift  | See <sup>(4)</sup>   |                             | $\pm 2$            |                    | $\mu\text{V}/\text{C}$ |

(1) All limits are ensured by testing or statistical analysis.

(2) Typical values represent the most likely parametric norm.

(3) Slew rate is the "worst case" of the rising and falling slew rates.

(4) Drift determined by dividing the change in parameter at temperature extremes by the total temperature change.

**Electrical Characteristics, ±5 V (continued)**

Unless otherwise specified, all limits ensured for at  $T_J = 25^\circ\text{C}$ ,  $V^+ = 5\text{ V}$ ,  $V^- = -5\text{ V}$ ,  $V_{\text{CM}} = V_O$ , and  $R_L = 100\ \Omega$  (or as specified) tied to 0 V.

| PARAMETER                        |   | TEST CONDITIONS  | MIN <sup>(1)</sup>          | TYP <sup>(2)</sup> | MAX <sup>(1)</sup> | UNIT                       |
|----------------------------------|---|--|-----------------------------|--------------------|--------------------|----------------------------|
| $I_B$                            | Input Bias Current                          | See <sup>(5)</sup>   |                             | -5                 | -20                | $\mu\text{A}$              |
|                                  |   |  | At the temperature extremes |                    | -30                |                            |
| $TC_{IB}$                        | Input Bias Current Average Drift            | See <sup>(4)</sup>   |                             | 0.01               |                    | $\text{nA}/^\circ\text{C}$ |
| $I_{OS}$                         | Input Offset Current                        |  |                             | 50                 | 300                | $\text{nA}$                |
|                                  |   | At the temperature extremes  |                             |                    | 500                |                            |
| CMRR                             | Common-Mode Rejection Ratio                 | $V_{\text{CM}}$ Stepped from $-5\text{ V}$ to $3\text{ V}$             | 75                          | 84                 |                    | dB                         |
| +PSRR                            | Positive Power Supply Rejection Ratio       | $V^+ = 4.5\text{ V}$ to $5.5\text{ V}$ , $V_{\text{CM}} = -4\text{ V}$ | 75                          | 82                 |                    | dB                         |
| -PSRR                            | Negative Power Supply Rejection Ratio       | $V^- = -4.5\text{ V}$ to $-5.5\text{ V}$                               | 78                          | 85                 |                    | dB                         |
| $I_S$                            | Supply Current (per channel)                | No load  |                             | 6.5                | 9                  | $\text{mA}$                |
|                                  |   | At the temperature extremes  |                             |                    | 11                 |                            |
| <b>MISCELLANEOUS PERFORMANCE</b> |   |  |                             |                    |                    |                            |
| $V_{OH}$                         | Output Swing High                           | $R_L = 2\text{ k}$   |                             | 4.1                | 4.25               | $\text{V}$                 |
|                                  |   |  | At the temperature extremes |                    | 3.8                |                            |
|                                  |   | $R_L = 150\ \Omega$  |                             | 4                  | 4.2                |                            |
|                                  |   |  | At the temperature extremes |                    | 3.7                |                            |
| $R_L = 75\ \Omega$               |   | 3.85   | 4.18                        |                    |                    |                            |
|                                  | At the temperature extremes                 |  | 3.5                         |                    |                    |                            |
| $V_{OL}$                         | Output Swing Low                            | $R_L = 2\text{ k}$   |                             | -4.05              | -4.19              | $\text{V}$                 |
|                                  |   |  | At the temperature extremes |                    | -3.8               |                            |
|                                  |   | $R_L = 150\ \Omega$  |                             | -3.9               | -4.05              |                            |
|                                  |   |  | At the temperature extremes |                    | -3.65              |                            |
| $R_L = 75\ \Omega$               |   | -3.8   | -4                          |                    |                    |                            |
|                                  | At the temperature extremes                 |  | -3.5                        |                    |                    |                            |
| $I_{OUT}$                        | Output Current                              | $V_{OUT} = 1\text{ V}$ from either rail                                | Sourcing                    | 45                 | 100                | $\text{mA}$                |
|                                  |   |  | Sinking                     | -45                | -110               |                            |
| $I_{SC}$                         | Output Short Circuit Current <sup>(6)</sup> | Sourcing to Ground   |                             | 120                | 180                | $\text{mA}$                |
|                                  |   |  | At the temperature extremes |                    | 100                |                            |
|                                  |   | Sinking to Ground  |                             | 120                | 230                |                            |
|                                  |   |  | At the temperature extremes |                    | 100                |                            |
| $R_{IN}$                         | Common-Mode Input Resistance                |  |                             | 4                  |                    | $\text{M}\Omega$           |
| $C_{IN}$                         | Common-Mode Input Capacitance               |  |                             | 1.8                |                    | $\text{pF}$                |
| $R_{OUT}$                        | Output Impedance                            | $f = 1\text{ MHz}$ , $A_V = +1$  |                             | 0.06               |                    | $\Omega$                   |

(5) Positive current corresponds to current flowing into the device.

(6) Short circuit test is a momentary test. See [Note 3](#) under *Absolute Maximum Ratings*.

### 6.7 Typical Characteristics

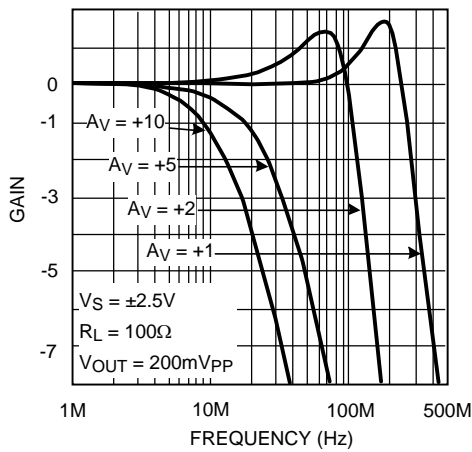

Figure 1. Noninverting Frequency Response, Gain

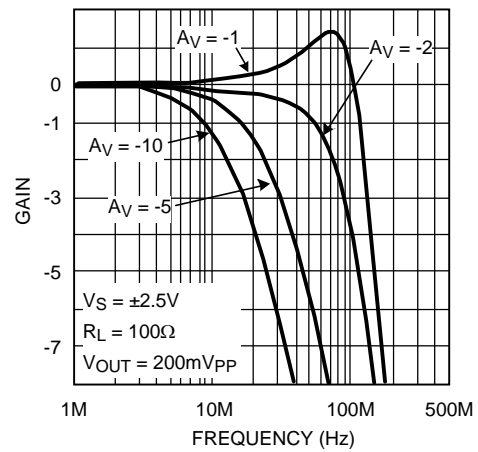

Figure 2. Inverting Frequency Response, Gain

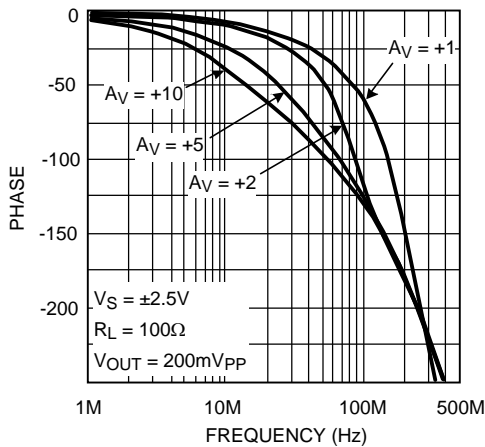

Figure 3. Noninverting Frequency Response, Phase

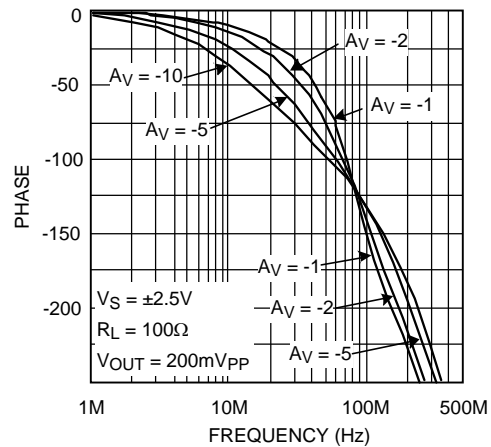

Figure 4. Inverting Frequency Response, Phase

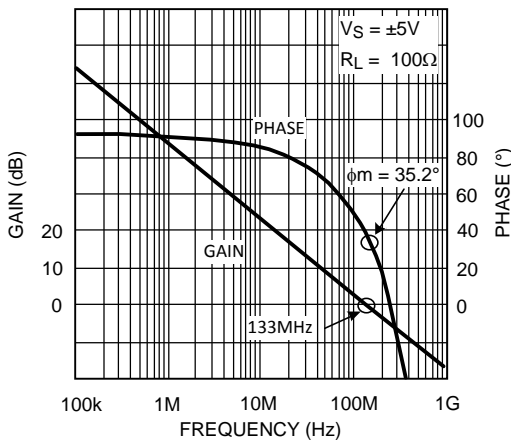

Figure 5. Open Loop Gain/Phase vs. Frequency

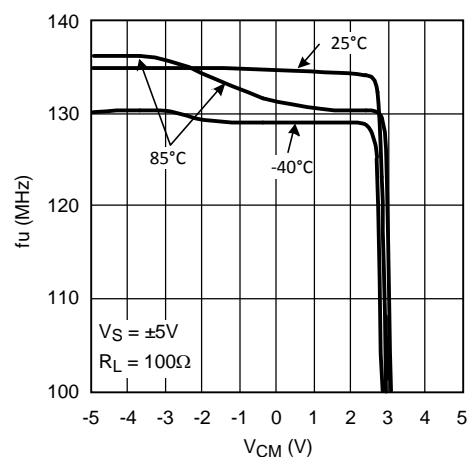

Figure 6. Unity Gain Frequency vs.  $V_{CM}$

Typical Characteristics (continued)

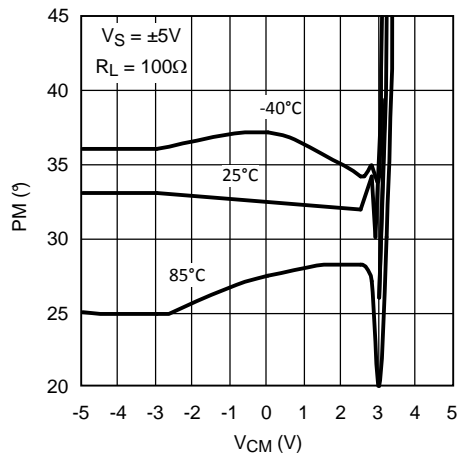

Figure 7. Phase Margin vs.  $V_{CM}$

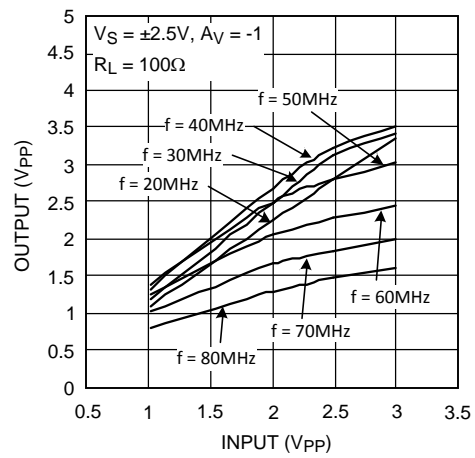

Figure 8. Output vs. Input

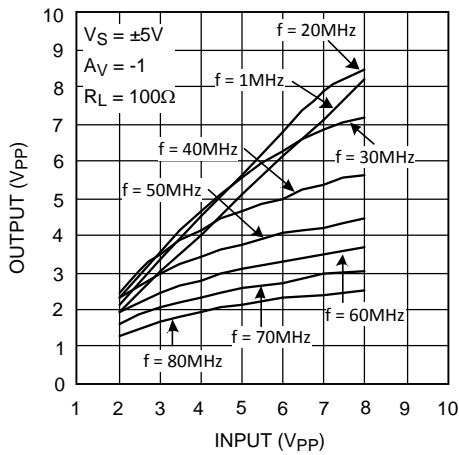

Figure 9. Output vs. Input

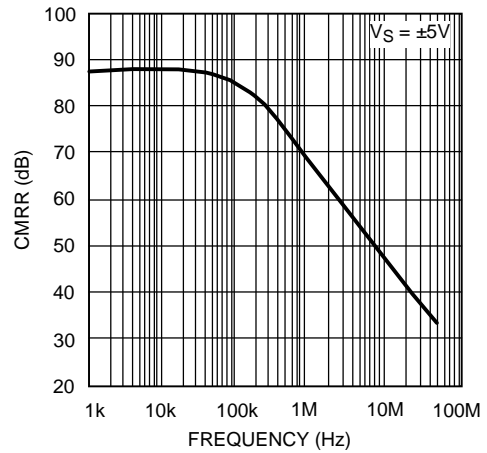

Figure 10. CMRR vs. Frequency

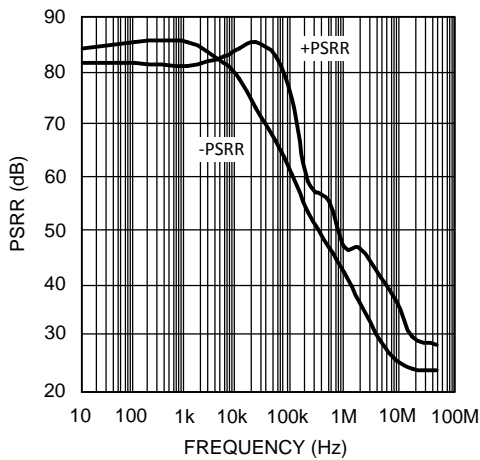

Figure 11. PSRR vs. Frequency

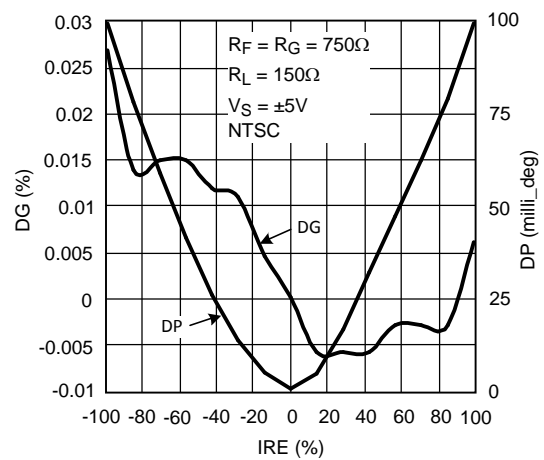

Figure 12. DG/DP vs. IRE

Typical Characteristics (continued)

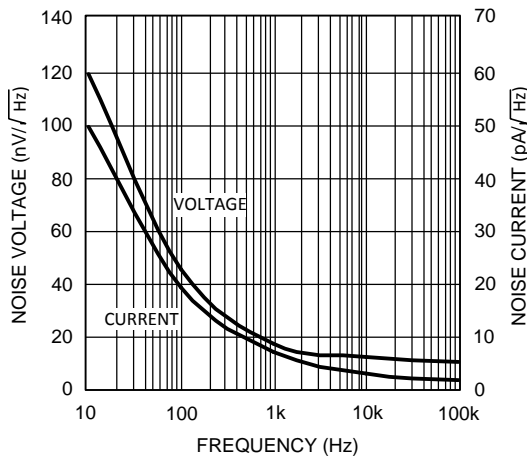

Figure 13. Noise vs. Frequency

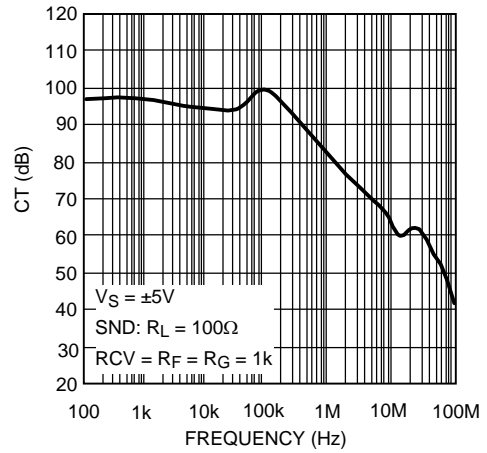

Figure 14. Crosstalk Rejection vs. Frequency

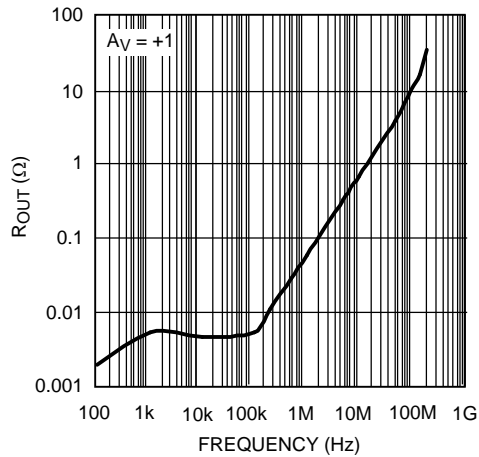

Figure 15. Output Impedance vs. Frequency

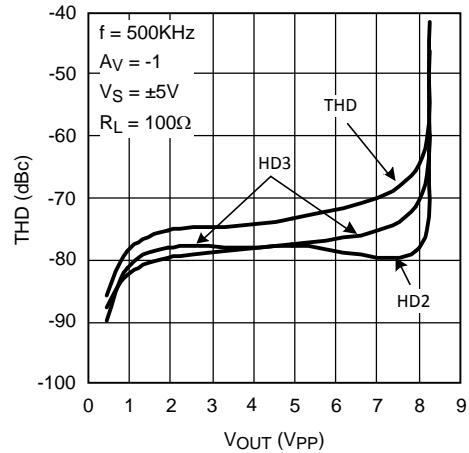

Figure 16. HD vs. VOUT

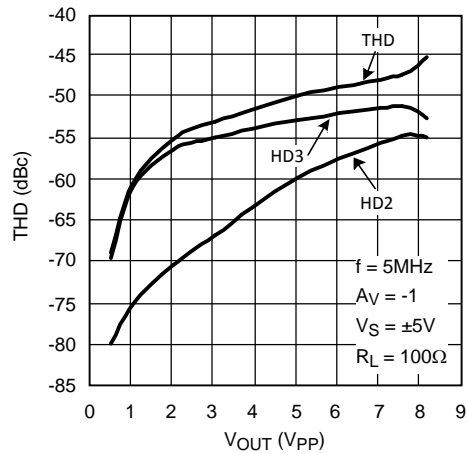

Figure 17. HD vs. VOUT

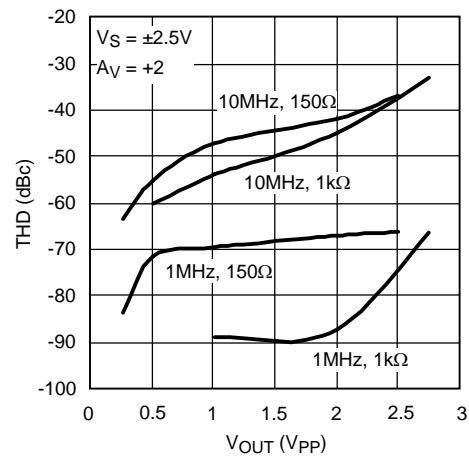

Figure 18. THD vs. VOUT

Typical Characteristics (continued)

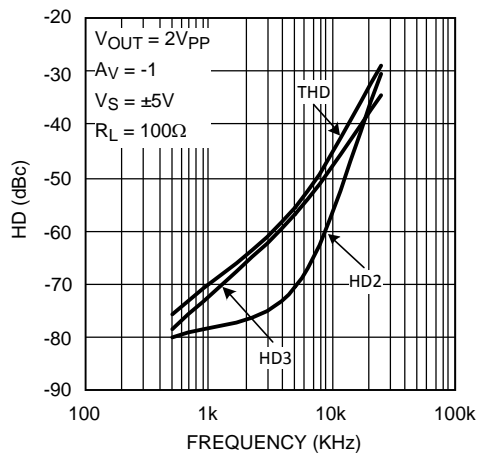

Figure 19. HD vs. Frequency

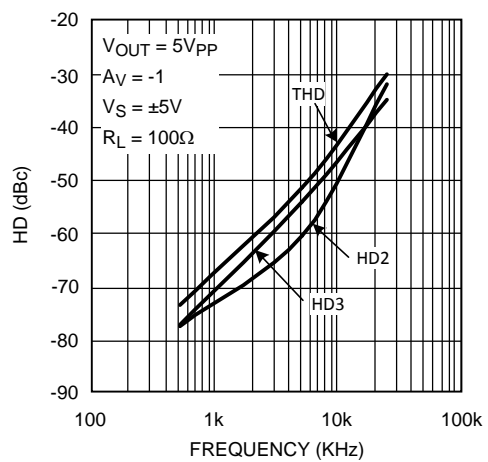

Figure 20. HD vs. Frequency

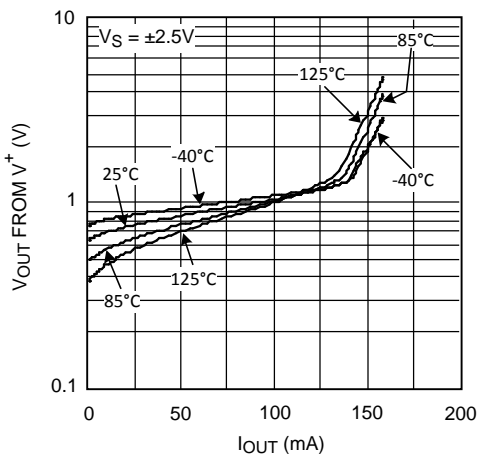

Figure 21.  $V_{OUT}$  vs.  $I_{SOURCE}$

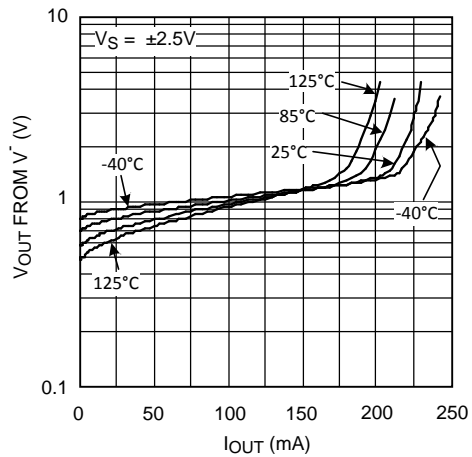

Figure 22.  $V_{OUT}$  vs.  $I_{SINK}$

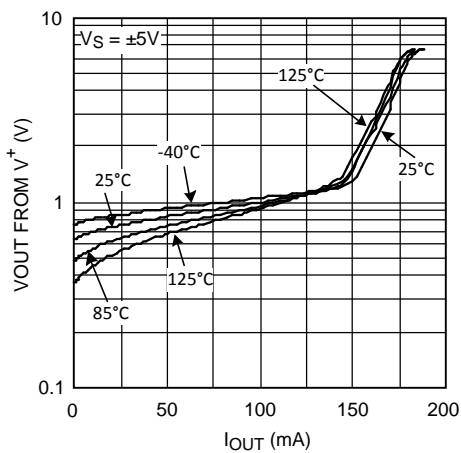

Figure 23.  $V_{OUT}$  vs.  $I_{SOURCE}$

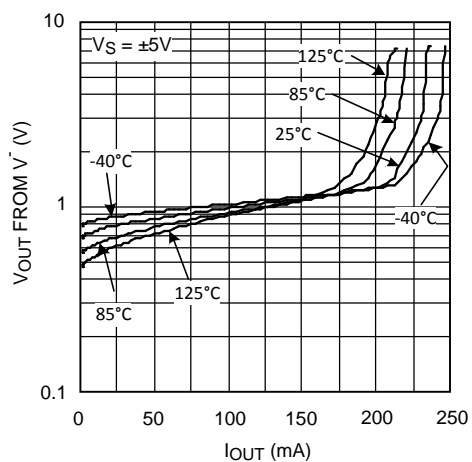

Figure 24.  $V_{OUT}$  vs.  $I_{SINK}$

Typical Characteristics (continued)

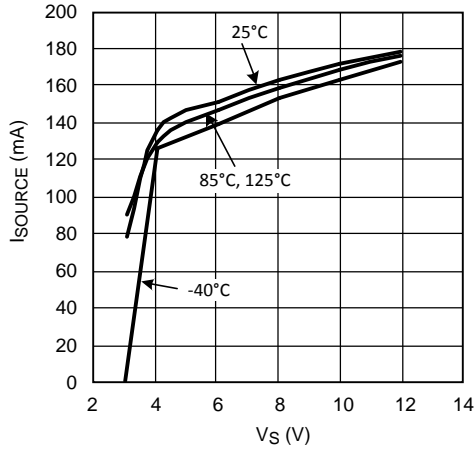

Figure 25. Short Circuit Current

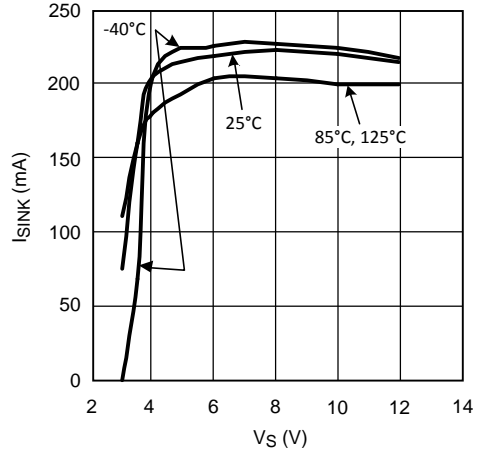

Figure 26. Short Circuit Current

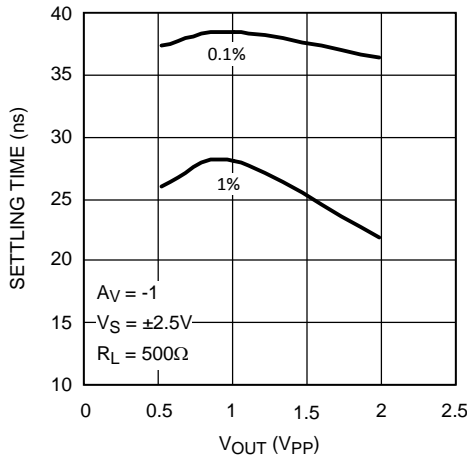

Figure 27. Settling Time vs. Output Step Amplitude

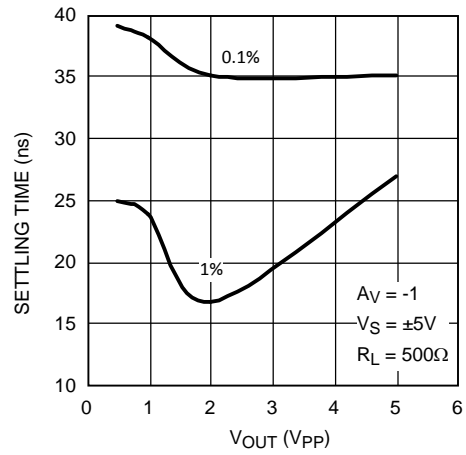

Figure 28. Settling Time vs. Output Step Amplitude

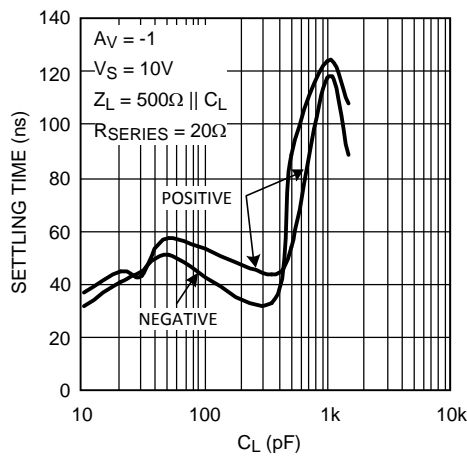

Figure 29. 0.1% Settling Time vs. Cap Load

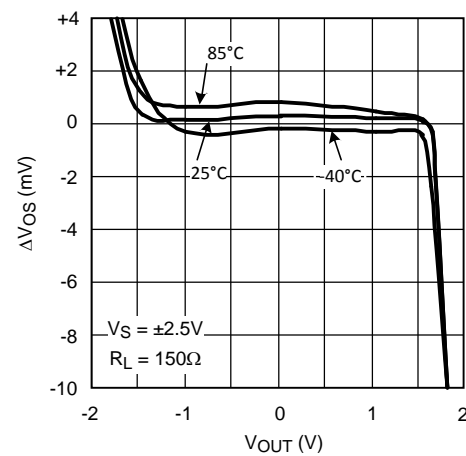

Figure 30.  $\Delta V_{OS}$  vs.  $V_{OUT}$

Typical Characteristics (continued)

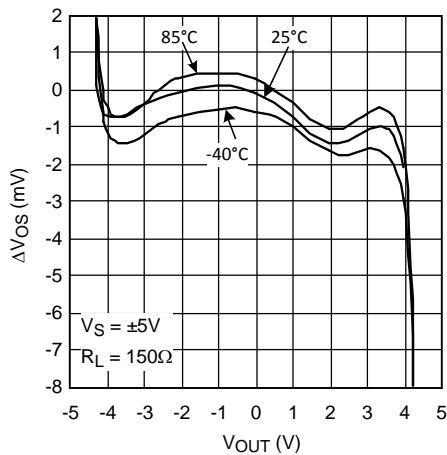

Figure 31.  $\Delta V_{OS}$  vs.  $V_{OUT}$

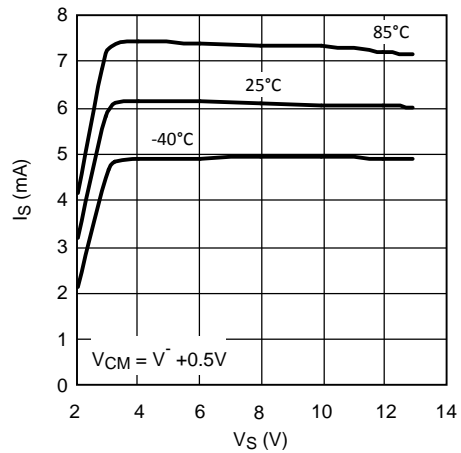

Figure 32.  $I_S$  /Amp vs.  $V_S$

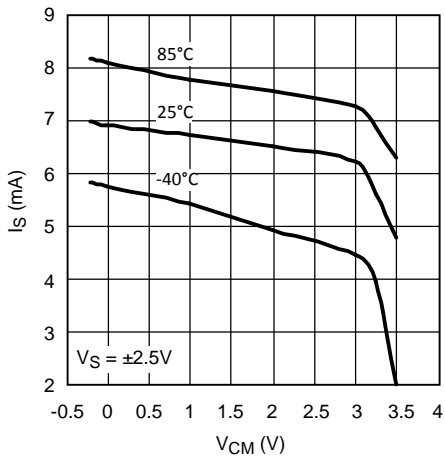

Figure 33.  $I_S$  /Amp vs.  $V_{CM}$

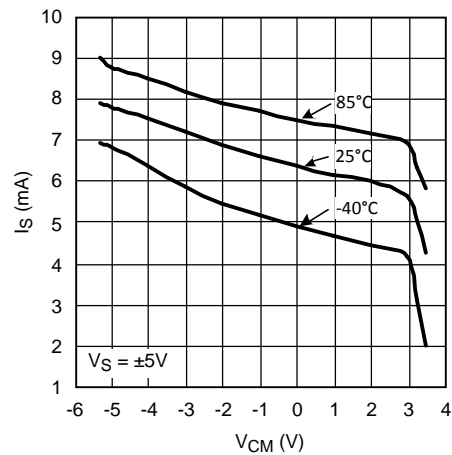

Figure 34.  $I_S$  /Amp vs.  $V_{CM}$

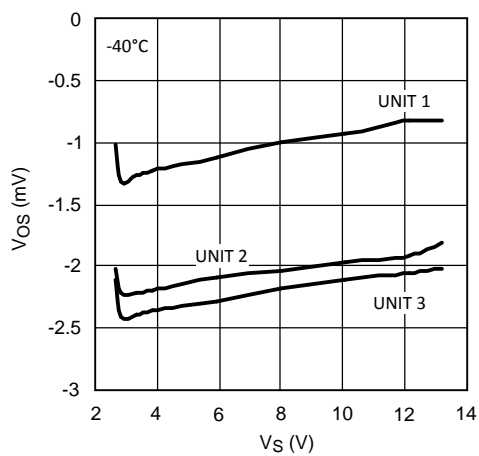

Figure 35.  $V_{OS}$  vs.  $V_S$  (for 3 Representative Units)

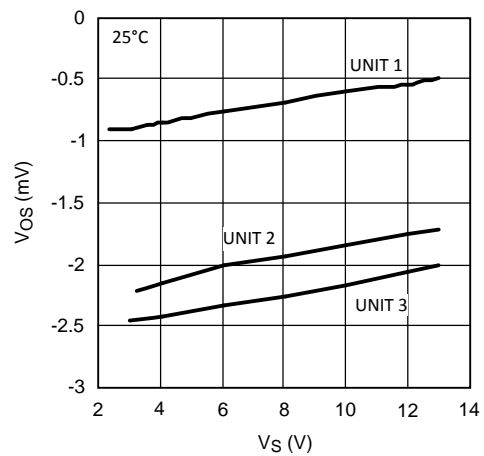

Figure 36.  $V_{OS}$  vs.  $V_S$  (for 3 Representative Units)

Typical Characteristics (continued)

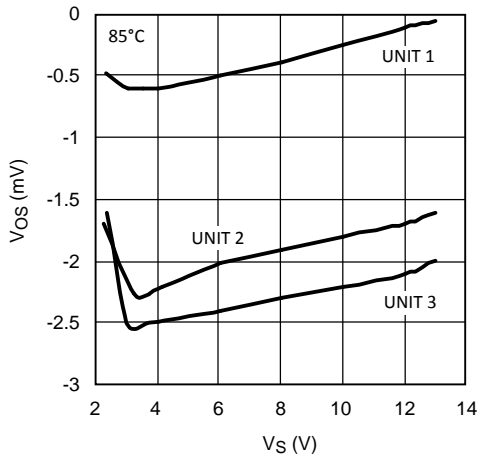

Figure 37.  $V_{OS}$  vs.  $V_S$  (for 3 Representative Units)

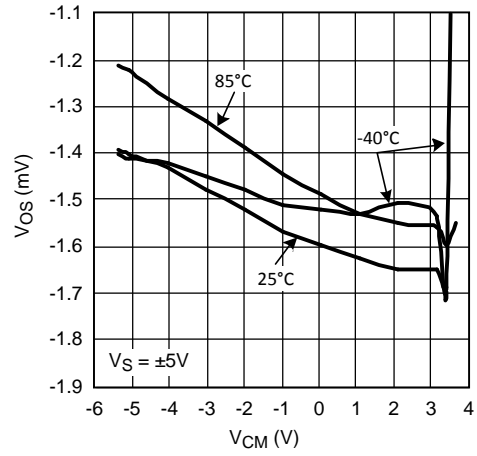

Figure 38.  $V_{OS}$  vs.  $V_{CM}$  (A Typical Unit)

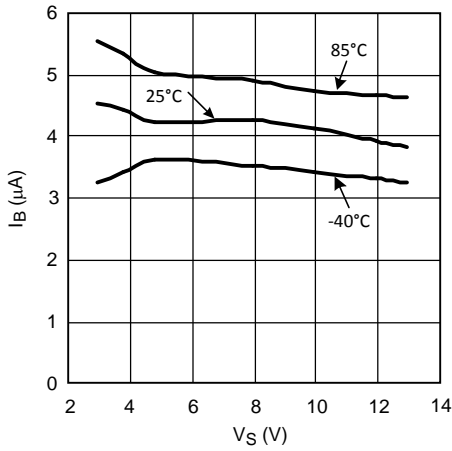

Figure 39.  $|I_B|$  vs.  $V_S$

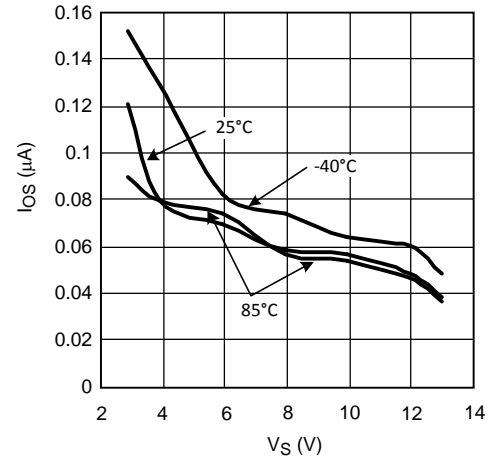

Figure 40.  $I_{OS}$  vs.  $V_S$

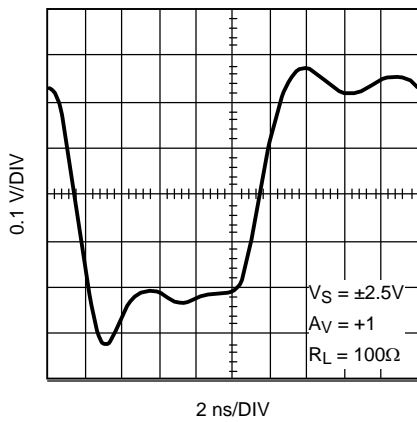

Figure 41. Small Signal Step Response

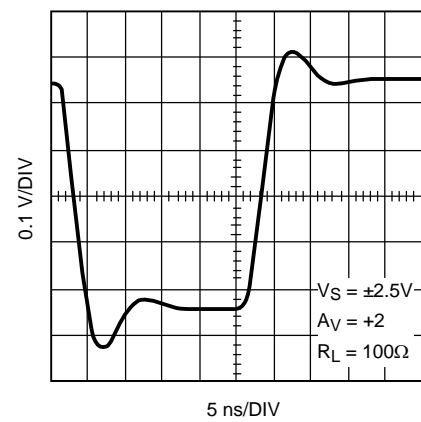
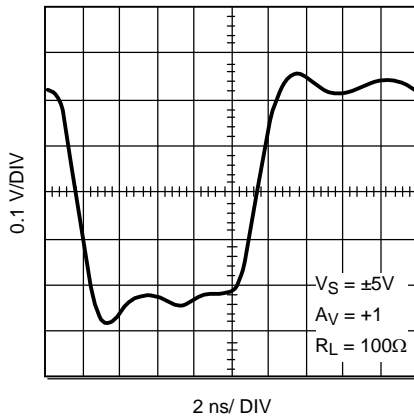
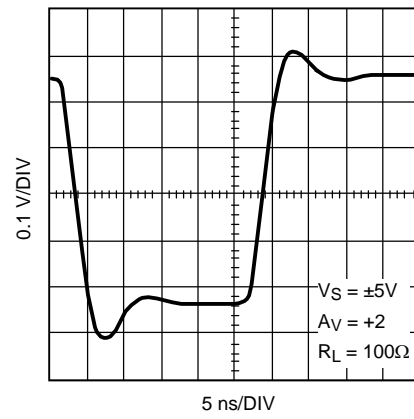

Figure 42. Small Signal Step Response

**Typical Characteristics (continued)**



**Figure 43. Small Signal Step Response**



**Figure 44. Small Signal Step Response**

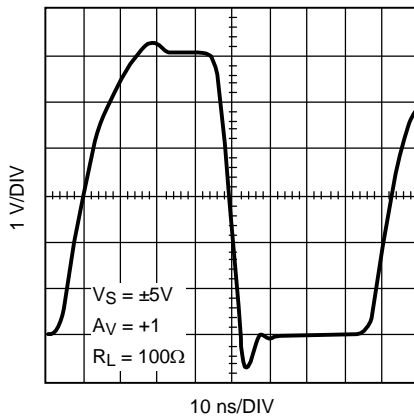

**Figure 45. Large Signal Step Response**

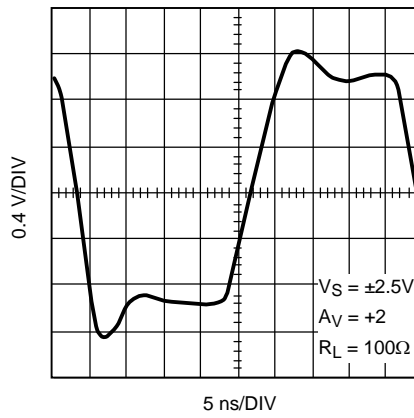

**Figure 46. Large Signal Step Response**

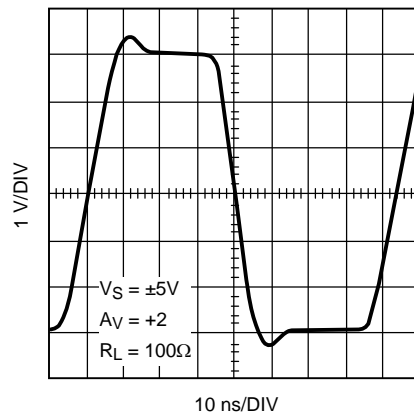

**Figure 47. Large Signal Step Response**

## 7 Detailed Description

### 7.1 Overview

#### 7.1.1 Large Signal Behavior

The LMH6657 and LMH6658 are large-bandwidth, fast slew rate, voltage feedback operational amplifiers ideal for high-speed, large signal applications. The low input referred voltage noise in conjunction with an input voltage range, which extends below  $V_-$ , eases the adoption of this part in applications having a tiny signal at or near system ground, as well as other high-speed, low-distortion, and low-noise systems. Also, the large Gain Bandwidth Product allows high gain operation that does not compromise speed.

### 7.2 Feature Description

The LMH6657 and LMH6658 input stage is designed to provide excess overdrive when needed. This occurs when fast input signal excursions cannot be followed by the output stage. In these situations, the device encounters larger input signals than would be encountered under normal closed loop conditions. The LMH6657 and LMH6658 input stage is designed to take advantage of this "input overdrive" condition. The larger the amount of this overdrive, the greater is the speed with which the output voltage can change. Here is a plot of how the output slew rate limitation varies with respect to the amount of overdrive imposed on the input:

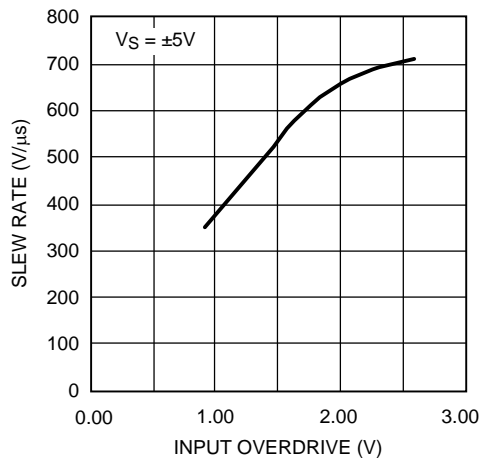

**Figure 48. Plot Showing the Relationship Between Slew Rate and Input Overdrive**

To relate the explanation above to a practical example, consider the following application example. Consider the case of a closed loop amplifier with a gain of  $-1$  amplifying a sinusoidal waveform. From the plot of Output vs. Input (Figure 8), with a 30-MHz signal and  $7V_{PP}$  input signal, it can be seen that the output will be limited to a swing of  $6.9 V_{PP}$ . From the frequency Response plot it can be seen that the inverting gain of  $-1$  has a  $-32^\circ$  output phase shift at this frequency.

It can be shown that this setup will result in about  $1.9 V_{PP}$  differential input voltage corresponding to  $650 V/\mu s$  of slew rate from Figure 48, above ( $SR = V_O(pp) \times \pi \times f = 650V/\mu s$ )

Note that the amount of overdrive appearing on the input for a given sinusoidal test waveform is affected by the following:

- Output swing
- Gain setting
- Input/output phase relationship for the given test frequency
- Amplifier configuration (inverting or noninverting)

Due to the higher frequency phase shift between input and output, there is no closed form solution to input overdrive for a given input. Therefore, Figure 48 is not very useful by itself in determining the output swing.

The following plots aid in predicting the output transition time based on the amount of swing required for a given gain setting.

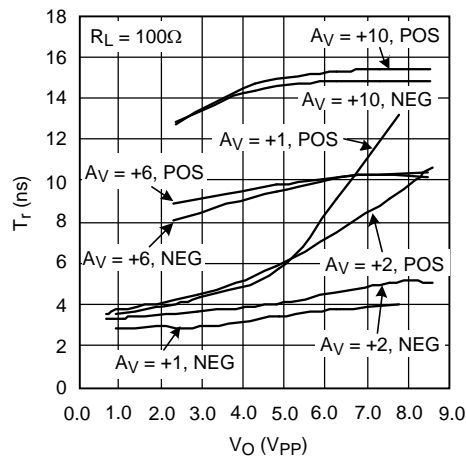
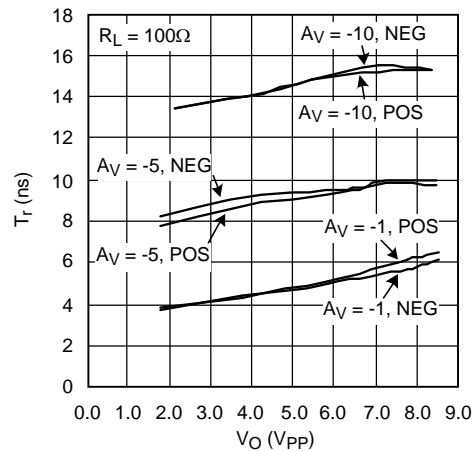
**Feature Description (continued)**

**Figure 49. Output 20%-80% Transition vs. Output Voltage Swing (Noninverting Gain)**

**Figure 50. Output 20%-80% Transition vs. Output Voltage Swing (Inverting Gain)**

Beyond a gain of 5 or so, the LMH6657/6658 output transition would be limited by bandwidth. For example, with a gain of 5, the  $-3\text{dB}$  BW would be around 30MHz corresponding to a rise time of about 12ns (10% - 90%). Assuming a near linear transition, the 20%-80% transition time would be around 9ns which matches the measured results as shown in [Figure 49](#).

When the output is heavily loaded, output swing may be limited by current capability of the device. Refer to [Output Current Capability](#) section for more details.

## 7.3 Device Functional Modes

### 7.3.1 Output Phase Reversal

This is a problem with some operational amplifiers. This effect is caused by phase reversal in the input stage due to saturation of one or more of the transistors when the inputs exceed the normal expected range of voltages. Some applications, such as servo control loops among others, are sensitive to this kind of behavior and would need special safeguards to ensure proper functioning. The LMH6657 and LMH6658 is immune to output phase reversal with input overload. With inputs exceeded, the LMH6657 and LMH6658 output will stay at the clamped voltage from the supply rail. Exceeding the input supply voltages beyond the [Absolute Maximum Ratings](#) of the device could however damage or otherwise adversely effect the reliability or life of the device.

## 8 Application and Implementation

### NOTE

Information in the following applications sections is not part of the TI component specification, and TI does not warrant its accuracy or completeness. TI's customers are responsible for determining suitability of components for their purposes. Customers should validate and test their design implementation to confirm system functionality.

### 8.1 Application Information

#### 8.1.1 Output Characteristics

##### 8.1.1.1 Output Current Capability

The LMH6657/6658 output swing for a given load can be determined by referring to the Output Voltage vs. Output Current plots in [Typical Characteristics](#). Characteristic Tables show the output current when the output is 1V from either rail. The plots and table values can be used to predict closed loop continuous value of current for a given load. If left unchecked, the output current capability of the LMH6657 and LMH6658 could easily result in junction temperature exceeding the maximum allowed value specified under [Absolute Maximum Ratings](#). Proper heat sinking or other precautions are required if conditions as such exist.

Under transient conditions, such as when the input voltage makes a large transition and the output has not had time to reach its final value, the device can deliver output currents in excess of the typical plots mentioned above. Plots shown in [Figure 51](#) and [Figure 52](#) depict how the output current capability improves under higher input overdrive voltages:

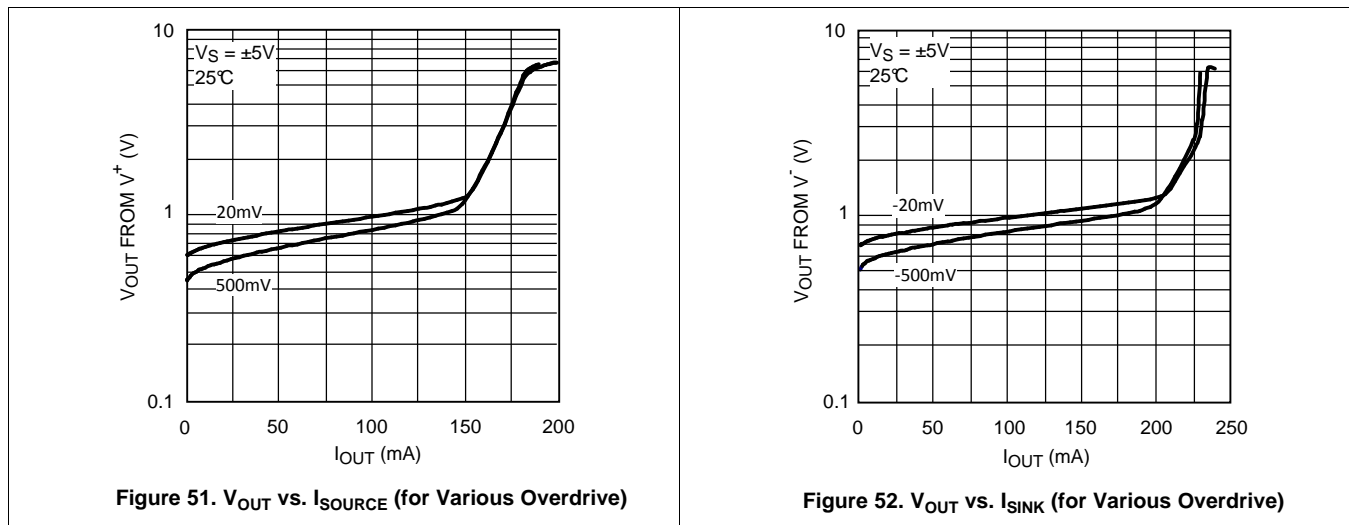

The LMH6657 and LMH6658 output stage is designed to swing within approximately one diode drop of each supply voltage by utilizing specially designed high speed output clamps. This allows adequate output voltage swing even with 5-V supplies and yet avoids some of the issues associated with rail-to-rail output operational amplifiers. Some of these issues are:

- Supply current increases when output reaches saturation at or near the supply rails
- Prolonged recovery when output approaches the rails

The LMH6657 and LMH6658 output is exceedingly well-behaved when it comes to recovering from an overload condition. As can be seen from [Figure 53](#), the LMH6657 and LMH6658 will typically recover from an output overload condition in about 18 ns, regardless of the duration of the overload.

## Application Information (continued)

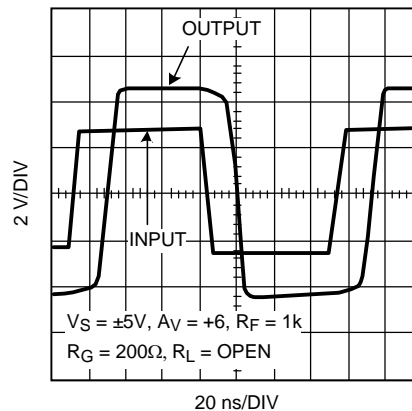

**Figure 53. Output Overload Recovery**

### 8.1.1.2 Driving Capacitive Loads

The LMH6657 and LMH6658 can drive moderate values of capacitance by utilizing a series isolation resistor between the output and the capacitive load. [Typical Characteristics](#) shows the settling time behavior for various capacitive loads and 20  $\Omega$  of isolation resistance. Capacitive load tolerance will improve with higher closed loop gain values. Applications such as ADC buffers, among others, present complex and varying capacitive loads to the operational amplifier; best value for this isolation resistance is often found by experimentation and actual trial and error for each application.

### 8.1.1.3 Distortion

Applications with demanding distortion performance requirements are best served with the device operating in the inverting mode. The reason for this is that in the inverting configuration, the input common-mode voltage does not vary with the signal and there is no subsequent ill effects due to this shift in operating point and the possibility of additional non-linearity. Moreover, under low closed loop gain settings (most suited to low distortion), the noninverting configuration is at a further disadvantage of having to contend with the input common mode voltage range. There is also a strong relationship between output loading and distortion performance (that is, 1 k $\Omega$  vs. 100  $\Omega$  distortion improves by about 20 dB at 100 KHz) especially at the lower frequency end where the distortion tends to be lower. At higher frequency, this dependence diminishes greatly such that this difference is only about 4 dB at 10 MHz. But, in general, lighter output load leads to reduced HD3 term and thus improves THD.

## 9 Power Supply Recommendations

The LMH665x can operate off a single-supply or with dual supplies. The input CM capability of the parts (CMVR) extends all the way down to the V- rail to simplify single-supply applications. Supplies should be decoupled with low-inductance, often ceramic, capacitors to ground less than 0.5 inches from the device pins. TI recommends the use of ground plane, and as in most high-speed devices, it is advisable to remove ground plane close to device sensitive pins such as the inputs.

## 10 Layout

### 10.1 Layout Guidelines

Generally, a good high frequency layout will keep power supply and ground traces away from the inverting input and output pins. Parasitic capacitances on these nodes to ground will cause frequency response peaking and possible circuit oscillations. See Application Note OA-15, *Frequent Faux Pas in Applying Wideband Current Feedback Amplifiers* (SNOA367) for more information. TI suggests the following evaluation boards as a guide for high frequency layout and as an aid in device testing and characterization:

**Layout Guidelines (continued)**

**Table 1. Evaluation Board Guide**

| DEVICE    | PACKAGE     | EVALUATION BOARD PIN |
|-----------|-------------|----------------------|
| LMH6657MF | SOT-23-5    | LMH730216            |
| LMH6657MG | SC-70       | LMH730165            |
| LMH6658MA | 8-Pin SOIC  | LMH730036            |
| LMH6658MM | 8-Pin VSSOP | LMH730123            |

Another important parameter in working with high speed/high performance amplifiers, is the component values selection. Choosing external resistors that are large in value will effect the closed loop behavior of the stage because of the interaction of these resistors with parasitic capacitances. These capacitors could be inherent to the device or a by-product of the board layout and component placement. Either way, keeping the resistor values lower, will diminish this interaction to a large extent. On the other hand, choosing very low value resistors will load down nodes and will contribute to higher overall power dissipation.

**10.2 Layout Example**

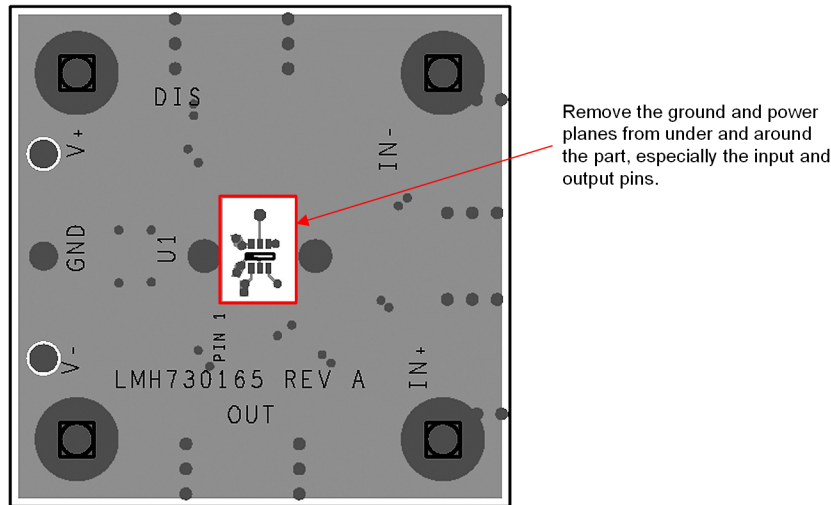

SC-70 Board Layout (Actual size = 1.5 in x 1.5 in)

**Figure 54. Layer 1 Silk**

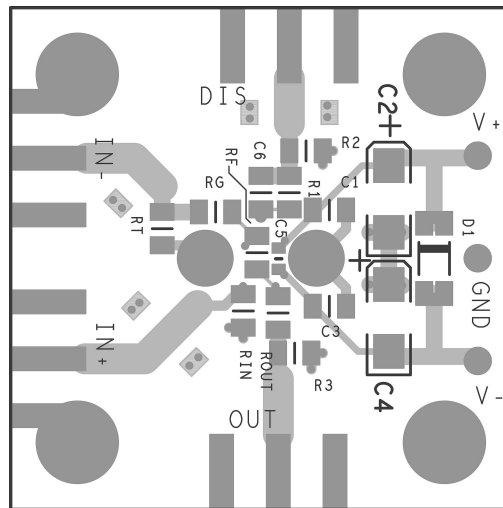
**Layout Example (continued)**

SC-70 Board Layout (Actual size = 1.5 in x 1.5 in)

**Figure 55. Layer 2 Silk**

## 11 Device and Documentation Support

### 11.1 Documentation Support

#### 11.1.1 Related Documentation

See Application Note OA-15, *Frequent Faux Pas in Applying Wideband Current Feedback Amplifiers*, [SNOA367](#)

### 11.2 Related Links

The table below lists quick access links. Categories include technical documents, support and community resources, tools and software, and quick access to sample or buy.

**Table 2. Related Links**

| PARTS   | PRODUCT FOLDER             | SAMPLE & BUY               | TECHNICAL DOCUMENTS        | TOOLS & SOFTWARE           | SUPPORT & COMMUNITY        |
|---------|----------------------------|----------------------------|----------------------------|----------------------------|----------------------------|
| LMH6657 | <a href="#">Click here</a> | <a href="#">Click here</a> | <a href="#">Click here</a> | <a href="#">Click here</a> | <a href="#">Click here</a> |
| LMH6658 | <a href="#">Click here</a> | <a href="#">Click here</a> | <a href="#">Click here</a> | <a href="#">Click here</a> | <a href="#">Click here</a> |

### 11.3 Community Resources

The following links connect to TI community resources. Linked contents are provided "AS IS" by the respective contributors. They do not constitute TI specifications and do not necessarily reflect TI's views; see TI's [Terms of Use](#).

**TI E2E™ Online Community** *TI's Engineer-to-Engineer (E2E) Community*. Created to foster collaboration among engineers. At [e2e.ti.com](http://e2e.ti.com), you can ask questions, share knowledge, explore ideas and help solve problems with fellow engineers.

**Design Support** *TI's Design Support* Quickly find helpful E2E forums along with design support tools and contact information for technical support.

### 11.4 Trademarks

E2E is a trademark of Texas Instruments.  
All other trademarks are the property of their respective owners.

### 11.5 Electrostatic Discharge Caution



These devices have limited built-in ESD protection. The leads should be shorted together or the device placed in conductive foam during storage or handling to prevent electrostatic damage to the MOS gates.

### 11.6 Glossary

[SLYZ022](#) — *TI Glossary*.

This glossary lists and explains terms, acronyms, and definitions.

## 12 Mechanical, Packaging, and Orderable Information

The following pages include mechanical, packaging, and orderable information. This information is the most current data available for the designated devices. This data is subject to change without notice and revision of this document. For browser-based versions of this data sheet, refer to the left-hand navigation.

**PACKAGING INFORMATION**

| Orderable Device | Status<br>(1) | Package Type | Package Drawing | Pins | Package Qty | Eco Plan<br>(2)         | Lead/Ball Finish<br>(6) | MSL Peak Temp<br>(3) | Op Temp (°C) | Device Marking<br>(4/5) | Samples                 |
|------------------|---------------|--------------|-----------------|------|-------------|-------------------------|-------------------------|----------------------|--------------|-------------------------|-------------------------|
| LMH6657MF/NOPB   | ACTIVE        | SOT-23       | DBV             | 5    | 1000        | Green (RoHS & no Sb/Br) | CU SN                   | Level-1-260C-UNLIM   | -40 to 85    | A85A                    | <a href="#">Samples</a> |
| LMH6657MFX/NOPB  | ACTIVE        | SOT-23       | DBV             | 5    | 3000        | Green (RoHS & no Sb/Br) | CU SN                   | Level-1-260C-UNLIM   | -40 to 85    | A85A                    | <a href="#">Samples</a> |
| LMH6657MG        | NRND          | SC70         | DCK             | 5    | 1000        | TBD                     | Call TI                 | Call TI              | -40 to 85    | A76                     |                         |
| LMH6657MG/NOPB   | ACTIVE        | SC70         | DCK             | 5    | 1000        | Green (RoHS & no Sb/Br) | CU SN                   | Level-1-260C-UNLIM   | -40 to 85    | A76                     | <a href="#">Samples</a> |
| LMH6658MA/NOPB   | ACTIVE        | SOIC         | D               | 8    | 95          | Green (RoHS & no Sb/Br) | CU SN                   | Level-1-260C-UNLIM   | -40 to 85    | LMH66<br>58MA           | <a href="#">Samples</a> |
| LMH6658MAX/NOPB  | ACTIVE        | SOIC         | D               | 8    | 2500        | Green (RoHS & no Sb/Br) | CU SN                   | Level-1-260C-UNLIM   | -40 to 85    | LMH66<br>58MA           | <a href="#">Samples</a> |
| LMH6658MM/NOPB   | ACTIVE        | VSSOP        | DGK             | 8    | 1000        | Green (RoHS & no Sb/Br) | CU SN                   | Level-1-260C-UNLIM   | -40 to 85    | A88A                    | <a href="#">Samples</a> |
| LMH6658MMX/NOPB  | ACTIVE        | VSSOP        | DGK             | 8    | 3500        | Green (RoHS & no Sb/Br) | CU SN                   | Level-1-260C-UNLIM   | -40 to 85    | A88A                    | <a href="#">Samples</a> |

(1) The marketing status values are defined as follows:

**ACTIVE:** Product device recommended for new designs.

**LIFEBUY:** TI has announced that the device will be discontinued, and a lifetime-buy period is in effect.

**NRND:** Not recommended for new designs. Device is in production to support existing customers, but TI does not recommend using this part in a new design.

**PREVIEW:** Device has been announced but is not in production. Samples may or may not be available.

**OBSOLETE:** TI has discontinued the production of the device.

(2) Eco Plan - The planned eco-friendly classification: Pb-Free (RoHS), Pb-Free (RoHS Exempt), or Green (RoHS & no Sb/Br) - please check <http://www.ti.com/productcontent> for the latest availability information and additional product content details.

**TBD:** The Pb-Free/Green conversion plan has not been defined.

**Pb-Free (RoHS):** TI's terms "Lead-Free" or "Pb-Free" mean semiconductor products that are compatible with the current RoHS requirements for all 6 substances, including the requirement that lead not exceed 0.1% by weight in homogeneous materials. Where designed to be soldered at high temperatures, TI Pb-Free products are suitable for use in specified lead-free processes.

**Pb-Free (RoHS Exempt):** This component has a RoHS exemption for either 1) lead-based flip-chip solder bumps used between the die and package, or 2) lead-based die adhesive used between the die and leadframe. The component is otherwise considered Pb-Free (RoHS compatible) as defined above.

**Green (RoHS & no Sb/Br):** TI defines "Green" to mean Pb-Free (RoHS compatible), and free of Bromine (Br) and Antimony (Sb) based flame retardants (Br or Sb do not exceed 0.1% by weight in homogeneous material)

(3) MSL, Peak Temp. - The Moisture Sensitivity Level rating according to the JEDEC industry standard classifications, and peak solder temperature.

(4) There may be additional marking, which relates to the logo, the lot trace code information, or the environmental category on the device.

<sup>(5)</sup> Multiple Device Markings will be inside parentheses. Only one Device Marking contained in parentheses and separated by a "~" will appear on a device. If a line is indented then it is a continuation of the previous line and the two combined represent the entire Device Marking for that device.

<sup>(6)</sup> Lead/Ball Finish - Orderable Devices may have multiple material finish options. Finish options are separated by a vertical ruled line. Lead/Ball Finish values may wrap to two lines if the finish value exceeds the maximum column width.

**Important Information and Disclaimer:**The information provided on this page represents TI's knowledge and belief as of the date that it is provided. TI bases its knowledge and belief on information provided by third parties, and makes no representation or warranty as to the accuracy of such information. Efforts are underway to better integrate information from third parties. TI has taken and continues to take reasonable steps to provide representative and accurate information but may not have conducted destructive testing or chemical analysis on incoming materials and chemicals. TI and TI suppliers consider certain information to be proprietary, and thus CAS numbers and other limited information may not be available for release.

In no event shall TI's liability arising out of such information exceed the total purchase price of the TI part(s) at issue in this document sold by TI to Customer on an annual basis.

**TAPE AND REEL INFORMATION**

**QUADRANT ASSIGNMENTS FOR PIN 1 ORIENTATION IN TAPE**

\*All dimensions are nominal

| Device          | Package Type | Package Drawing | Pins | SPQ  | Reel Diameter (mm) | Reel Width W1 (mm) | A0 (mm) | B0 (mm) | K0 (mm) | P1 (mm) | W (mm) | Pin1 Quadrant |
|-----------------|--------------|-----------------|------|------|--------------------|--------------------|---------|---------|---------|---------|--------|---------------|
| LMH6657MF/NOPB  | SOT-23       | DBV             | 5    | 1000 | 178.0              | 8.4                | 3.2     | 3.2     | 1.4     | 4.0     | 8.0    | Q3            |
| LMH6657MFX/NOPB | SOT-23       | DBV             | 5    | 3000 | 178.0              | 8.4                | 3.2     | 3.2     | 1.4     | 4.0     | 8.0    | Q3            |
| LMH6657MG       | SC70         | DCK             | 5    | 1000 | 178.0              | 8.4                | 2.25    | 2.45    | 1.2     | 4.0     | 8.0    | Q3            |
| LMH6657MG/NOPB  | SC70         | DCK             | 5    | 1000 | 178.0              | 8.4                | 2.25    | 2.45    | 1.2     | 4.0     | 8.0    | Q3            |
| LMH6658MAX/NOPB | SOIC         | D               | 8    | 2500 | 330.0              | 12.4               | 6.5     | 5.4     | 2.0     | 8.0     | 12.0   | Q1            |
| LMH6658MM/NOPB  | VSSOP        | DGK             | 8    | 1000 | 178.0              | 12.4               | 5.3     | 3.4     | 1.4     | 8.0     | 12.0   | Q1            |
| LMH6658MMX/NOPB | VSSOP        | DGK             | 8    | 3500 | 330.0              | 12.4               | 5.3     | 3.4     | 1.4     | 8.0     | 12.0   | Q1            |

**TAPE AND REEL BOX DIMENSIONS**

\*All dimensions are nominal

| Device          | Package Type | Package Drawing | Pins | SPQ  | Length (mm) | Width (mm) | Height (mm) |
|-----------------|--------------|-----------------|------|------|-------------|------------|-------------|
| LMH6657MF/NOPB  | SOT-23       | DBV             | 5    | 1000 | 210.0       | 185.0      | 35.0        |
| LMH6657MFX/NOPB | SOT-23       | DBV             | 5    | 3000 | 210.0       | 185.0      | 35.0        |
| LMH6657MG       | SC70         | DCK             | 5    | 1000 | 210.0       | 185.0      | 35.0        |
| LMH6657MG/NOPB  | SC70         | DCK             | 5    | 1000 | 210.0       | 185.0      | 35.0        |
| LMH6658MAX/NOPB | SOIC         | D               | 8    | 2500 | 367.0       | 367.0      | 35.0        |
| LMH6658MM/NOPB  | VSSOP        | DGK             | 8    | 1000 | 210.0       | 185.0      | 35.0        |
| LMH6658MMX/NOPB | VSSOP        | DGK             | 8    | 3500 | 367.0       | 367.0      | 35.0        |

DCK (R-PDSO-G5)

PLASTIC SMALL-OUTLINE PACKAGE



- NOTES:
- A. All linear dimensions are in millimeters.
  - B. This drawing is subject to change without notice.
  - C. Body dimensions do not include mold flash or protrusion. Mold flash and protrusion shall not exceed 0.15 per side.
  - D. Falls within JEDEC MO-203 variation AA.

DCK (R-PDSO-G5)

PLASTIC SMALL OUTLINE

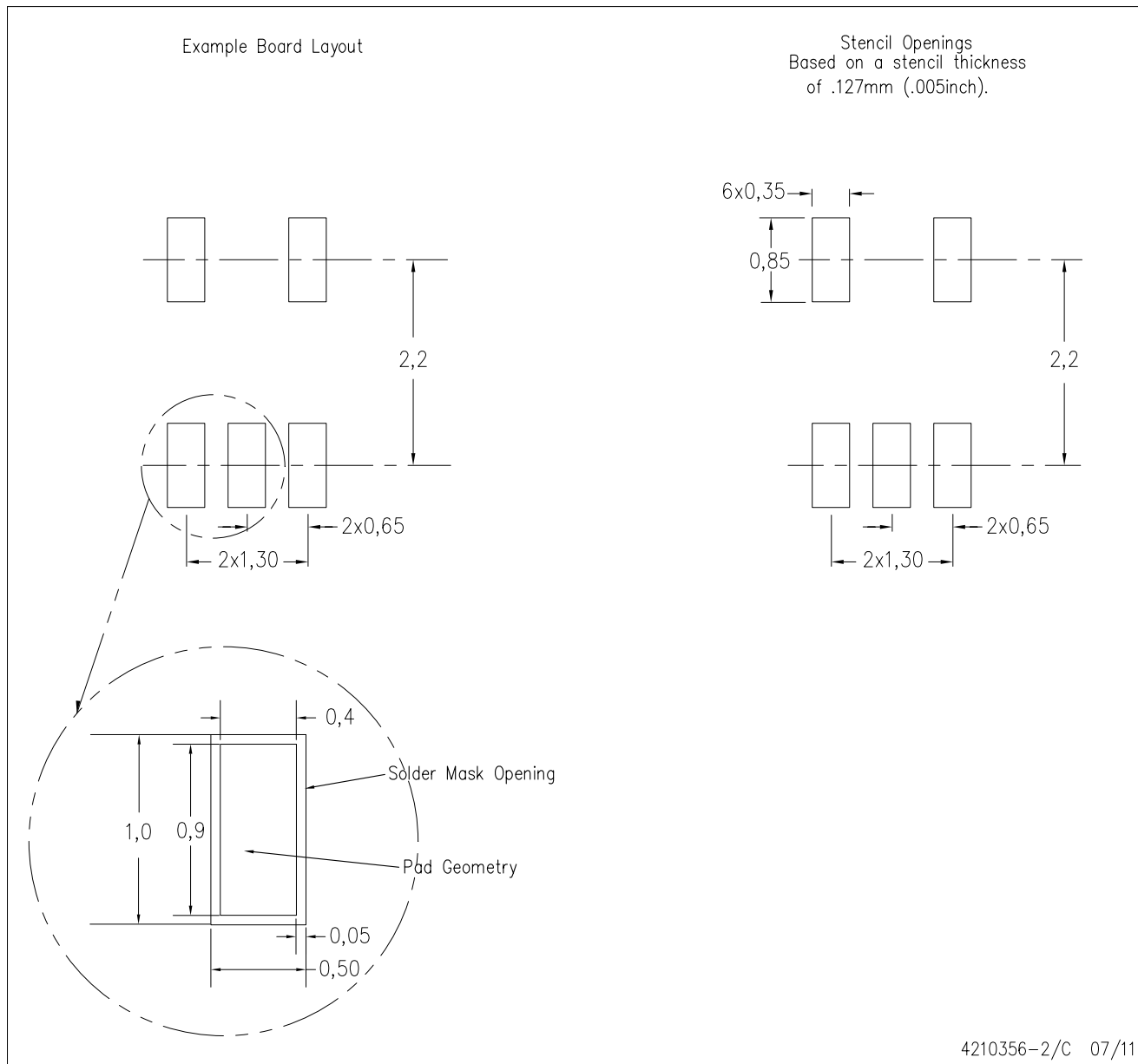

- NOTES:
- All linear dimensions are in millimeters.
  - This drawing is subject to change without notice.
  - Customers should place a note on the circuit board fabrication drawing not to alter the center solder mask defined pad.
  - Publication IPC-7351 is recommended for alternate designs.
  - Laser cutting apertures with trapezoidal walls and also rounding corners will offer better paste release. Customers should contact their board assembly site for stencil design recommendations. Example stencil design based on a 50% volumetric metal load solder paste. Refer to IPC-7525 for other stencil recommendations.



D0008A

# PACKAGE OUTLINE

SOIC - 1.75 mm max height

SMALL OUTLINE INTEGRATED CIRCUIT



NOTES:

1. Linear dimensions are in inches [millimeters]. Dimensions in parenthesis are for reference only. Controlling dimensions are in inches. Dimensioning and tolerancing per ASME Y14.5M.
2. This drawing is subject to change without notice.
3. This dimension does not include mold flash, protrusions, or gate burrs. Mold flash, protrusions, or gate burrs shall not exceed  $.006$  [0.15] per side.
4. This dimension does not include interlead flash.
5. Reference JEDEC registration MS-012, variation AA.

# EXAMPLE BOARD LAYOUT

D0008A

SOIC - 1.75 mm max height

SMALL OUTLINE INTEGRATED CIRCUIT



LAND PATTERN EXAMPLE  
EXPOSED METAL SHOWN  
SCALE:8X



SOLDER MASK DETAILS

4214825/C 02/2019

NOTES: (continued)

- 6. Publication IPC-7351 may have alternate designs.
- 7. Solder mask tolerances between and around signal pads can vary based on board fabrication site.

# EXAMPLE STENCIL DESIGN

D0008A

SOIC - 1.75 mm max height

SMALL OUTLINE INTEGRATED CIRCUIT



SOLDER PASTE EXAMPLE  
BASED ON .005 INCH [0.125 MM] THICK STENCIL  
SCALE:8X

4214825/C 02/2019

NOTES: (continued)

8. Laser cutting apertures with trapezoidal walls and rounded corners may offer better paste release. IPC-7525 may have alternate design recommendations.
9. Board assembly site may have different recommendations for stencil design.



# EXAMPLE BOARD LAYOUT

DBV0005A

SOT-23 - 1.45 mm max height

SMALL OUTLINE TRANSISTOR



LAND PATTERN EXAMPLE  
EXPOSED METAL SHOWN  
SCALE:15X



SOLDER MASK DETAILS

4214839/D 11/2018

NOTES: (continued)

- 5. Publication IPC-7351 may have alternate designs.
- 6. Solder mask tolerances between and around signal pads can vary based on board fabrication site.

# EXAMPLE STENCIL DESIGN

DBV0005A

SOT-23 - 1.45 mm max height

SMALL OUTLINE TRANSISTOR



SOLDER PASTE EXAMPLE  
BASED ON 0.125 mm THICK STENCIL  
SCALE:15X

4214839/D 11/2018

NOTES: (continued)

7. Laser cutting apertures with trapezoidal walls and rounded corners may offer better paste release. IPC-7525 may have alternate design recommendations.
8. Board assembly site may have different recommendations for stencil design.

DGK (S-PDSO-G8)

PLASTIC SMALL-OUTLINE PACKAGE

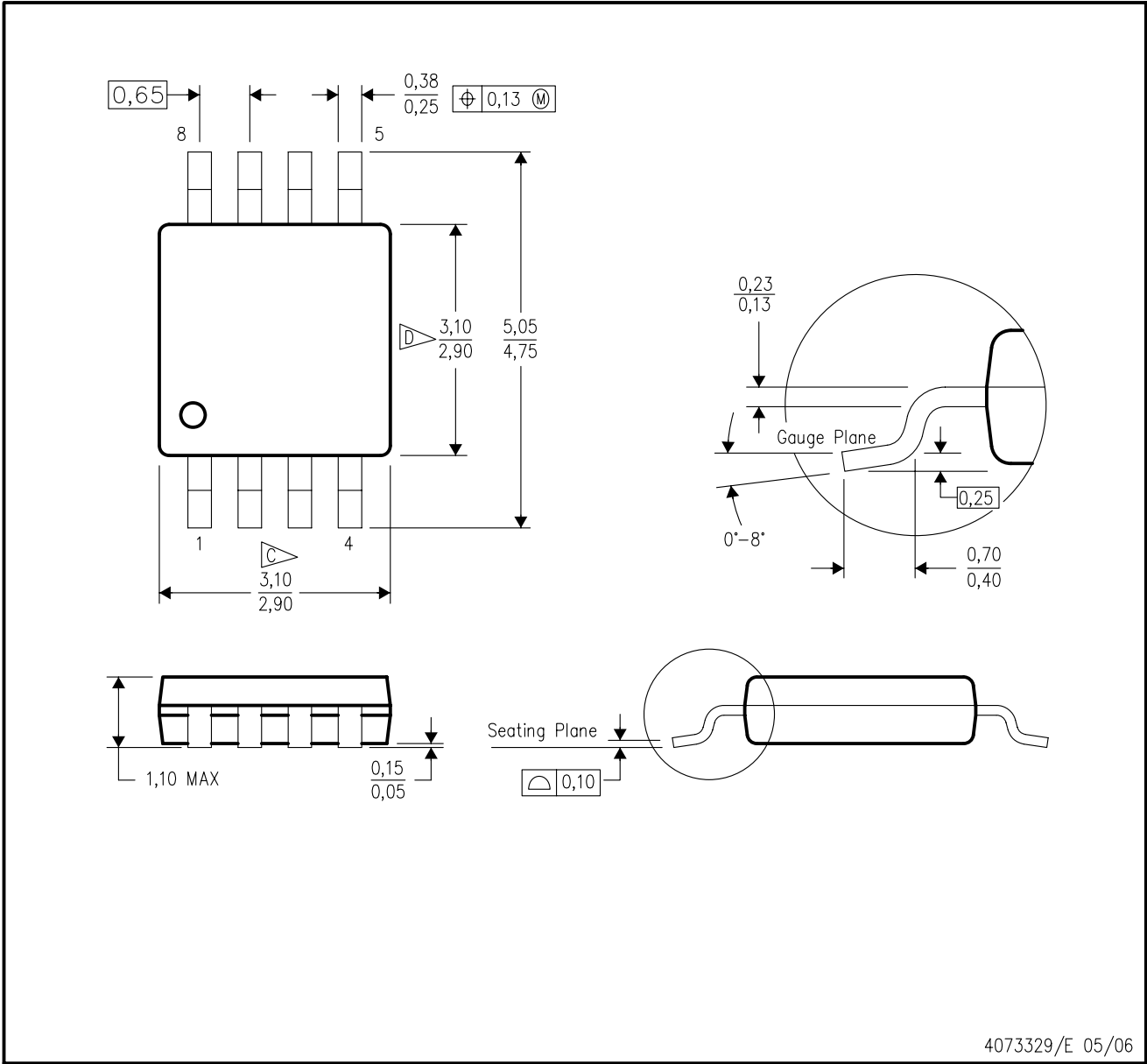

4073329/E 05/06

- NOTES:
- A. All linear dimensions are in millimeters.
  - B. This drawing is subject to change without notice.
  - C. Body length does not include mold flash, protrusions, or gate burrs. Mold flash, protrusions, or gate burrs shall not exceed 0.15 per end.
  - D. Body width does not include interlead flash. Interlead flash shall not exceed 0.50 per side.
  - E. Falls within JEDEC MO-187 variation AA, except interlead flash.



- NOTES:
- A. All linear dimensions are in millimeters.
  - B. This drawing is subject to change without notice.
  - C. Publication IPC-7351 is recommended for alternate designs.
  - D. Laser cutting apertures with trapezoidal walls and also rounding corners will offer better paste release. Customers should contact their board assembly site for stencil design recommendations. Refer to IPC-7525 for other stencil recommendations.
  - E. Customers should contact their board fabrication site for solder mask tolerances between and around signal pads.

## IMPORTANT NOTICE AND DISCLAIMER

TI PROVIDES TECHNICAL AND RELIABILITY DATA (INCLUDING DATASHEETS), DESIGN RESOURCES (INCLUDING REFERENCE DESIGNS), APPLICATION OR OTHER DESIGN ADVICE, WEB TOOLS, SAFETY INFORMATION, AND OTHER RESOURCES "AS IS" AND WITH ALL FAULTS, AND DISCLAIMS ALL WARRANTIES, EXPRESS AND IMPLIED, INCLUDING WITHOUT LIMITATION ANY IMPLIED WARRANTIES OF MERCHANTABILITY, FITNESS FOR A PARTICULAR PURPOSE OR NON-INFRINGEMENT OF THIRD PARTY INTELLECTUAL PROPERTY RIGHTS.

These resources are intended for skilled developers designing with TI products. You are solely responsible for (1) selecting the appropriate TI products for your application, (2) designing, validating and testing your application, and (3) ensuring your application meets applicable standards, and any other safety, security, or other requirements. These resources are subject to change without notice. TI grants you permission to use these resources only for development of an application that uses the TI products described in the resource. Other reproduction and display of these resources is prohibited. No license is granted to any other TI intellectual property right or to any third party intellectual property right. TI disclaims responsibility for, and you will fully indemnify TI and its representatives against, any claims, damages, costs, losses, and liabilities arising out of your use of these resources.

TI's products are provided subject to TI's Terms of Sale ([www.ti.com/legal/termsofsale.html](http://www.ti.com/legal/termsofsale.html)) or other applicable terms available either on [ti.com](http://ti.com) or provided in conjunction with such TI products. TI's provision of these resources does not expand or otherwise alter TI's applicable warranties or warranty disclaimers for TI products.

Mailing Address: Texas Instruments, Post Office Box 655303, Dallas, Texas 75265  
Copyright © 2019, Texas Instruments Incorporated

## Looking for pricing, stock, or lifecycle information?

Click below to explore more details on WIN SOURCE:

 [View LMH6657MFX/NOPB on WIN SOURCE](#)

 [Texas Instruments](#) Information

## Optimize Your Supply Chain with WIN SOURCE Solutions

-  Global Sourcing Solution
-  Obsolete Management
-  Cost Control Management
-  Shortage Management
-  Alternative Solution
-  Excess Inventory Management