



Is Now Part of



ON Semiconductor®

To learn more about ON Semiconductor, please visit our website at
www.onsemi.com

Please note: As part of the Fairchild Semiconductor integration, some of the Fairchild orderable part numbers will need to change in order to meet ON Semiconductor's system requirements. Since the ON Semiconductor product management systems do not have the ability to manage part nomenclature that utilizes an underscore (_), the underscore (_) in the Fairchild part numbers will be changed to a dash (-). This document may contain device numbers with an underscore (_). Please check the ON Semiconductor website to verify the updated device numbers. The most current and up-to-date ordering information can be found at www.onsemi.com. Please email any questions regarding the system integration to Fairchild_questions@onsemi.com.

ON Semiconductor and the ON Semiconductor logo are trademarks of Semiconductor Components Industries, LLC dba ON Semiconductor or its subsidiaries in the United States and/or other countries. ON Semiconductor owns the rights to a number of patents, trademarks, copyrights, trade secrets, and other intellectual property. A listing of ON Semiconductor's product/patent coverage may be accessed at www.onsemi.com/site/pdf/Patent-Marking.pdf. ON Semiconductor reserves the right to make changes without further notice to any products herein. ON Semiconductor makes no warranty, representation or guarantee regarding the suitability of its products for any particular purpose, nor does ON Semiconductor assume any liability arising out of the application or use of any product or circuit, and specifically disclaims any and all liability, including without limitation special, consequential or incidental damages. Buyer is responsible for its products and applications using ON Semiconductor products, including compliance with all laws, regulations and safety requirements or standards, regardless of any support or applications information provided by ON Semiconductor. "Typical" parameters which may be provided in ON Semiconductor data sheets and/or specifications can and do vary in different applications and actual performance may vary over time. All operating parameters, including "Typicals" must be validated for each customer application by customer's technical experts. ON Semiconductor does not convey any license under its patent rights nor the rights of others. ON Semiconductor products are not designed, intended, or authorized for use as a critical component in life support systems or any FDA Class 3 medical devices or medical devices with a same or similar classification in a foreign jurisdiction or any devices intended for implantation in the human body. Should Buyer purchase or use ON Semiconductor products for any such unintended or unauthorized application, Buyer shall indemnify and hold ON Semiconductor and its officers, employees, subsidiaries, affiliates, and distributors harmless against all claims, costs, damages, and expenses, and reasonable attorney fees arising out of, directly or indirectly, any claim of personal injury or death associated with such unintended or unauthorized use, even if such claim alleges that ON Semiconductor was negligent regarding the design or manufacture of the part. ON Semiconductor is an Equal Opportunity/Affirmative Action Employer. This literature is subject to all applicable copyright laws and is not for resale in any manner.



August 2016

FDP12N50NZ / FDPF12N50NZ

N-Channel UniFET™ II MOSFET

500 V, 11.5 A, 520 mΩ

Features

- $R_{DS(on)} = 460 \text{ m}\Omega$ (Typ.) @ $V_{GS} = 10 \text{ V}$, $I_D = 5.75 \text{ A}$
- Low Gate Charge (Typ. 23 nC)
- Low C_{rss} (Typ. 14 pF)
- 100% Avalanche Tested
- ESD Improved Capability
- RoHS Compliant

Applications

- LCD/LED/PDP TV
- Lighting
- Uninterruptible Power Supply

Description

UniFET™ II MOSFET is Fairchild Semiconductor's high voltage MOSFET family based on advanced planar stripe and DMOS technology. This advanced MOSFET family has the smallest on-state resistance among the planar MOSFET, and also provides superior switching performance and higher avalanche energy strength. In addition, internal gate-source ESD diode allows UniFET II MOSFET to withstand over 2kV HBM surge stress. This device family is suitable for switching power converter applications such as power factor correction (PFC), flat panel display (FPD) TV power, ATX and electronic lamp ballasts.

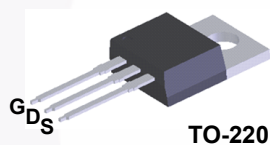

TO-220

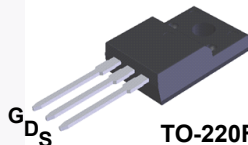

TO-220F

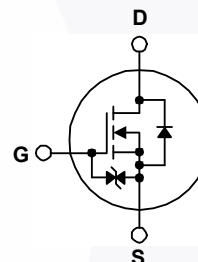

MOSFET Maximum Ratings $T_C = 25^\circ\text{C}$ unless otherwise noted.

Symbol	Parameter	FDP12N50NZ	FDPF12N50NZ	Unit
V_{DSS}	Drain to Source Voltage	500		V
V_{GSS}	Gate to Source Voltage	± 25		V
I_D	Drain Current	- Continuous ($T_C = 25^\circ\text{C}$)	11.5	11.5*
		- Continuous ($T_C = 100^\circ\text{C}$)	6.9	6.9*
I_{DM}	Drain Current	- Pulsed (Note 1)	46	46*
E_{AS}	Single Pulsed Avalanche Energy (Note 2)	560		mJ
I_{AR}	Avalanche Current (Note 1)	11.5		A
E_{AR}	Repetitive Avalanche Energy (Note 1)	17		mJ
dv/dt	MOSFET dv/dt Ruggedness	20		V/ns
	Peak Diode Recovery dv/dt (Note 3)	10		V/ns
P_D	Power Dissipation	($T_C = 25^\circ\text{C}$)	170	42
		- Derate above 25°C	1.37	0.33
T_J, T_{STG}	Operating and Storage Temperature Range	-55 to +150		$^\circ\text{C}$
T_L	Maximum Lead Temperature for Soldering, 1/8" from Case for 5 Seconds	300		$^\circ\text{C}$

*Drain current limited by maximum junction temperature

Thermal Characteristics

Symbol	Parameter	FDP12N50NZ	FDPF12N50NZ	Unit
$R_{\theta JC}$	Thermal Resistance, Junction to Case, Max.	0.73	3.0	$^\circ\text{C}/\text{W}$
$R_{\theta JA}$	Thermal Resistance, Junction to Ambient, Max.	62.5	62.5	

Package Marking and Ordering Information

Device Marking	Device	Package	Reel Size	Tape Width	Quantity
FDP12N50NZ	FDP12N50NZ	TO-220	Tube	N/A	50 units
FDPF12N50NZ	FDPF12N50NZ	TO-220F	Tube	N/A	50 units

Electrical Characteristics $T_C = 25^\circ\text{C}$ unless otherwise noted.

Symbol	Parameter	Test Conditions	Min.	Typ.	Max.	Unit
--------	-----------	-----------------	------	------	------	------

Off Characteristics

BV_{DSS}	Drain to Source Breakdown Voltage	$I_D = 250\mu\text{A}$, $V_{GS} = 0\text{V}$, $T_J = 25^\circ\text{C}$	500	-	-	V
$\Delta BV_{DSS} / \Delta T_J$	Breakdown Voltage Temperature Coefficient	$I_D = 250\mu\text{A}$, Referenced to 25°C	-	0.5	-	$\text{V}/^\circ\text{C}$
I_{DSS}	Zero Gate Voltage Drain Current	$V_{DS} = 500\text{V}$, $V_{GS} = 0\text{V}$ $V_{DS} = 400\text{V}$, $T_C = 125^\circ\text{C}$	-	-	1 10	μA
I_{GSS}	Gate to Body Leakage Current	$V_{GS} = \pm 25\text{V}$, $V_{DS} = 0\text{V}$	-	-	± 10	μA

On Characteristics

$V_{GS(th)}$	Gate Threshold Voltage	$V_{GS} = V_{DS}$, $I_D = 250\mu\text{A}$	3.0	-	5.0	V
$R_{DS(on)}$	Static Drain to Source On Resistance	$V_{GS} = 10\text{V}$, $I_D = 5.75\text{A}$	-	0.46	0.52	Ω
g_{FS}	Forward Transconductance	$V_{DS} = 20\text{V}$, $I_D = 5.75\text{A}$	-	12	-	S

Dynamic Characteristics

C_{iss}	Input Capacitance	$V_{DS} = 25\text{V}$, $V_{GS} = 0\text{V}$ $f = 1\text{MHz}$	-	945	1235	pF
C_{oss}	Output Capacitance		-	155	205	pF
C_{riss}	Reverse Transfer Capacitance		-	14	20	pF
Q_g	Total Gate Charge at 10V	$V_{DS} = 400\text{V}$, $I_D = 11.5\text{A}$ $V_{GS} = 10\text{V}$	-	23	30	nC
Q_{gs}	Gate to Source Gate Charge		-	5.5	-	nC
Q_{gd}	Gate to Drain "Miller" Charge		(Note 4)	-	9.6	-

Switching Characteristics

$t_{d(on)}$	Turn-On Delay Time	$V_{DD} = 250\text{V}$, $I_D = 11.5\text{A}$ $R_G = 25\Omega$	-	20	50	ns
t_r	Turn-On Rise Time		-	50	110	ns
$t_{d(off)}$	Turn-Off Delay Time		-	60	130	ns
t_f	Turn-Off Fall Time		(Note 4)	-	45	100

Drain-Source Diode Characteristics

I_S	Maximum Continuous Drain to Source Diode Forward Current	-	-	11.5	A	
I_{SM}	Maximum Pulsed Drain to Source Diode Forward Current	-	-	46	A	
V_{SD}	Drain to Source Diode Forward Voltage	$V_{GS} = 0\text{V}$, $I_{SD} = 11.5\text{A}$	-	-	1.4	V
t_{rr}	Reverse Recovery Time	$V_{GS} = 0\text{V}$, $I_{SD} = 11.5\text{A}$ $di_F/dt = 100\text{A}/\mu\text{s}$	-	315	-	ns
Q_{rr}	Reverse Recovery Charge		-	2.0	-	μC

Notes:

1. Repetitive Rating: Pulse width limited by maximum junction temperature
2. $L = 8.5\text{mH}$, $I_{AS} = 11.5\text{A}$, $V_{DD} = 50\text{V}$, $R_G = 25\Omega$, Starting $T_J = 25^\circ\text{C}$
3. $I_{SD} \leq 11.5\text{A}$, $di/dt \leq 200\text{A}/\mu\text{s}$, $V_{DD} \leq BV_{DSS}$, Starting $T_J = 25^\circ\text{C}$
4. Essentially Independent of Operating Temperature Typical Characteristics

Typical Characteristics

Figure 1. On-Region Characteristics

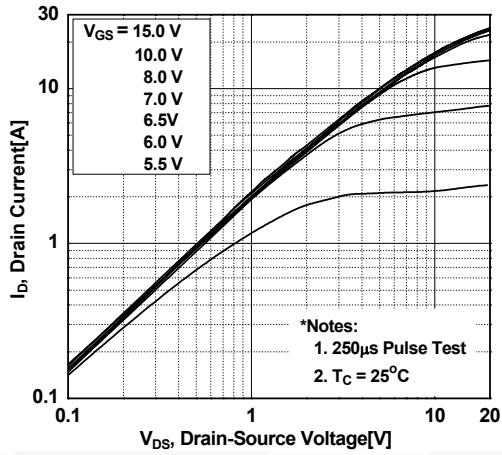

Figure 2. Transfer Characteristics

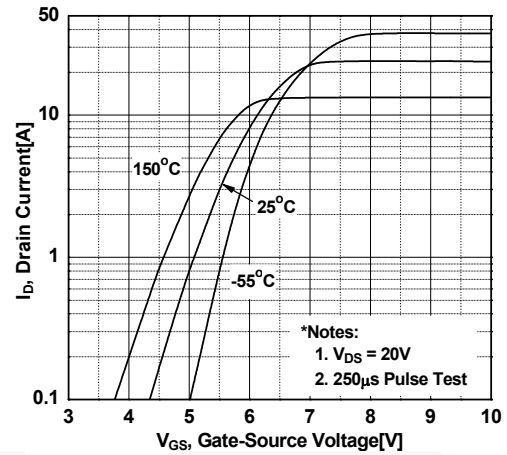

Figure 3. On-Resistance Variation vs. Drain Current and Gate Voltage

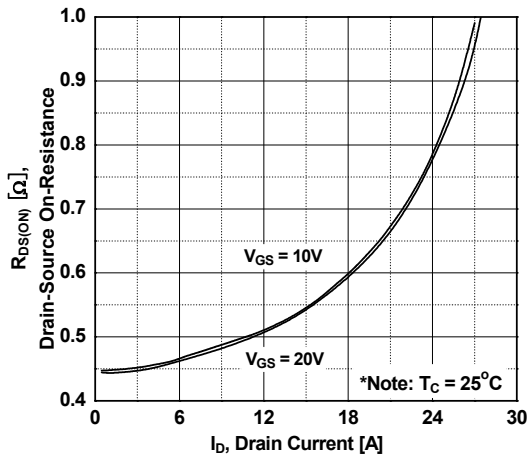

Figure 4. Body Diode Forward Voltage Variation vs. Source Current and Temperature

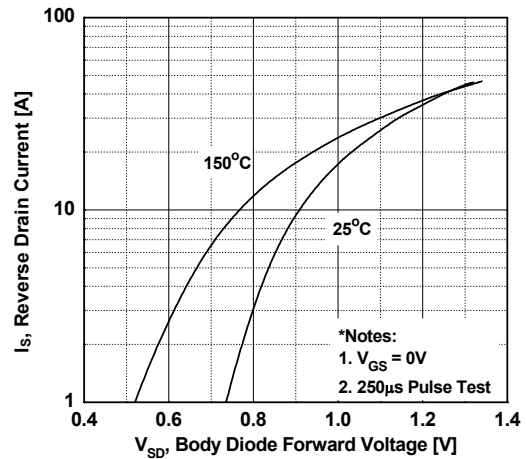

Figure 5. Capacitance Characteristics

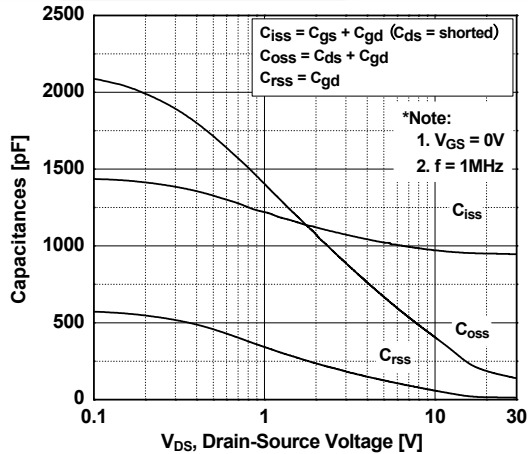
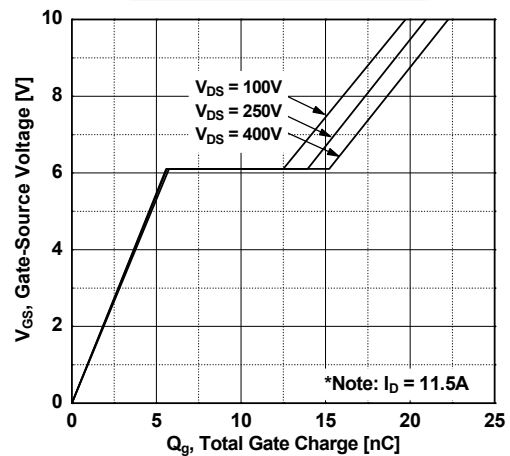

Figure 6. Gate Charge Characteristics



Typical Characteristics (Continued)

Figure 7. Breakdown Voltage Variation vs. Temperature

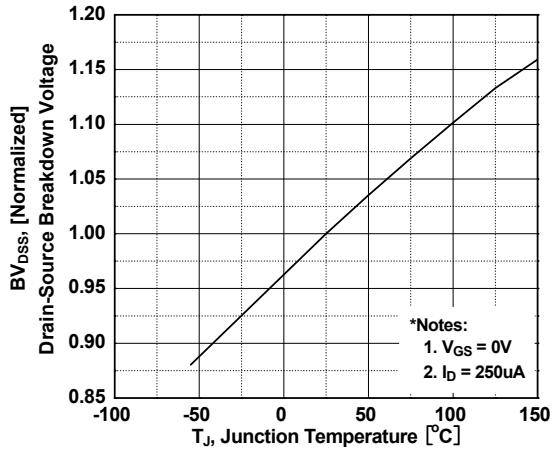

Figure 8. On-Resistance Variation vs. Temperature

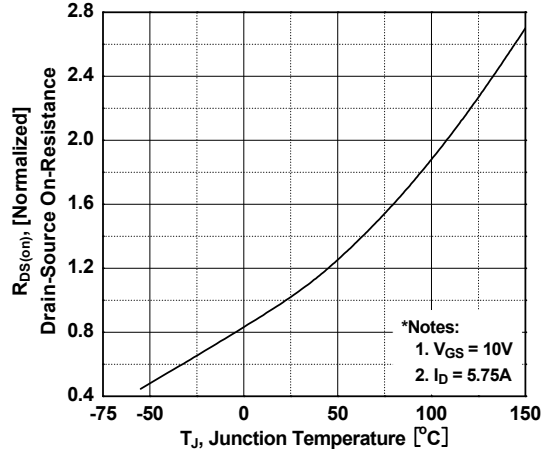

Figure 9. Maximum Safe Operating Area - FDP12N50NZ

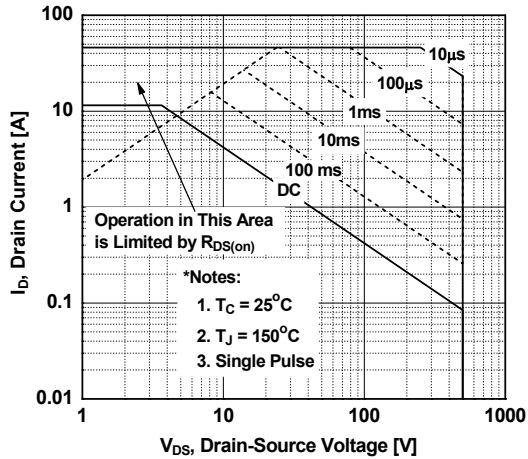

Figure 10. Maximum Safe Operating Area - FDP12N50NZ

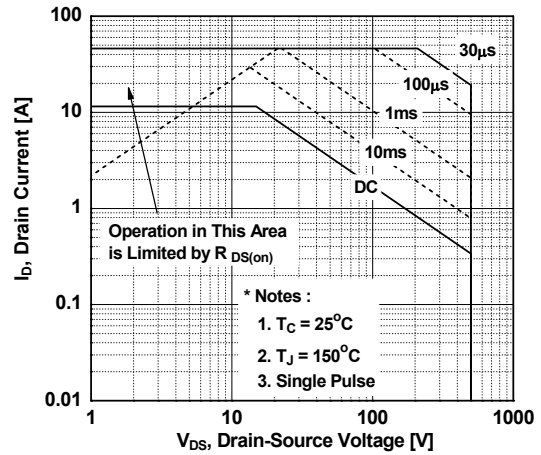
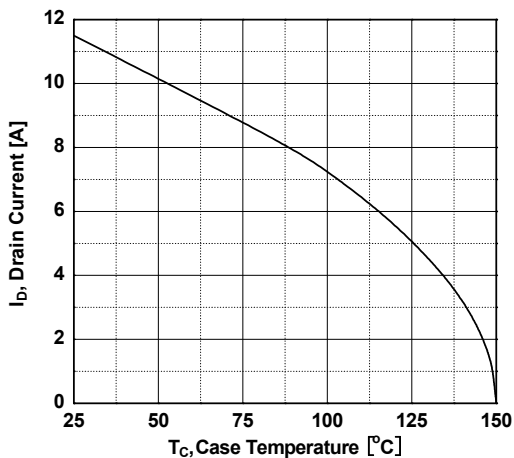

Figure 11. Maximum Drain Current vs. Case Temperature



Typical Characteristics (Continued)

Figure 12. Transient Thermal Response Curve - FDP12N50NZ

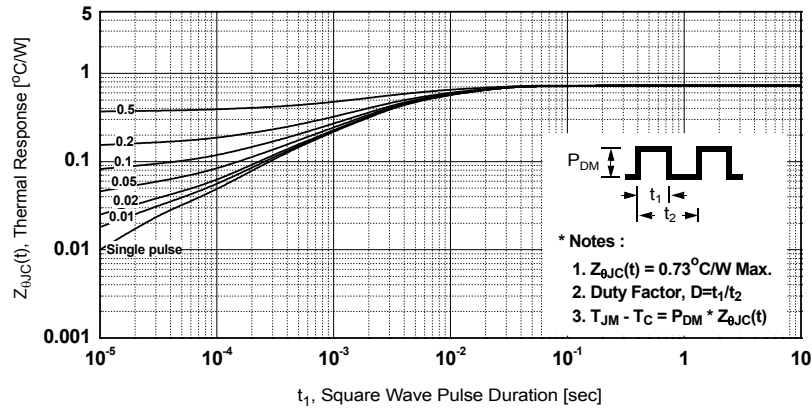

Figure 13. Transient Thermal Response Curve - FDPF12N50NZ

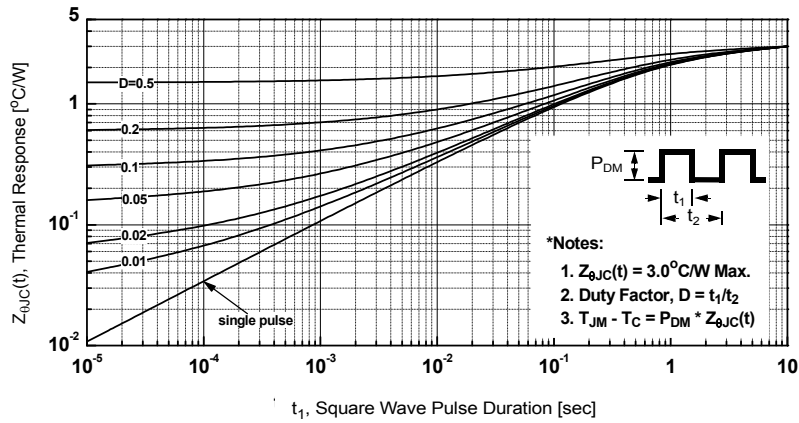

Figure 14. Gate Charge Test Circuit & Waveform

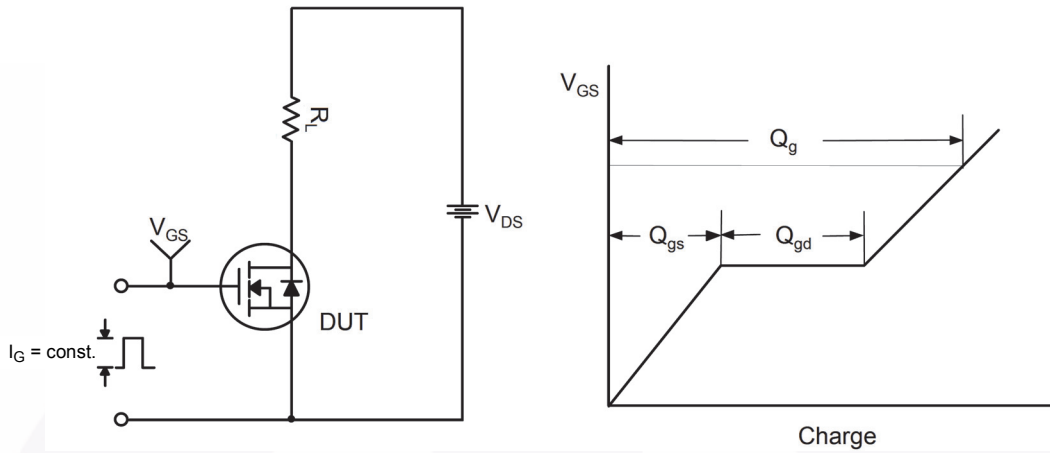

Figure 15. Resistive Switching Test Circuit & Waveforms

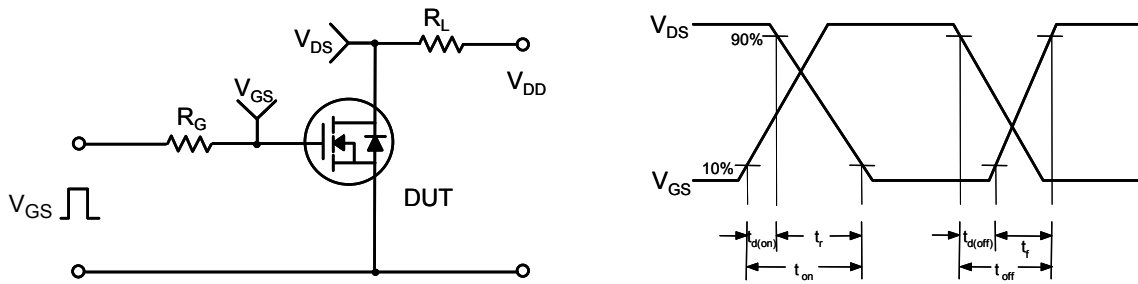

Figure 16. Unclamped Inductive Switching Test Circuit & Waveforms

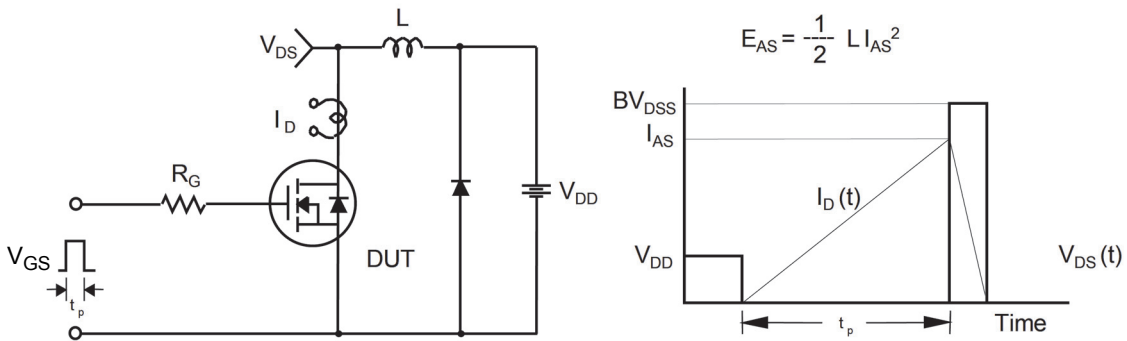
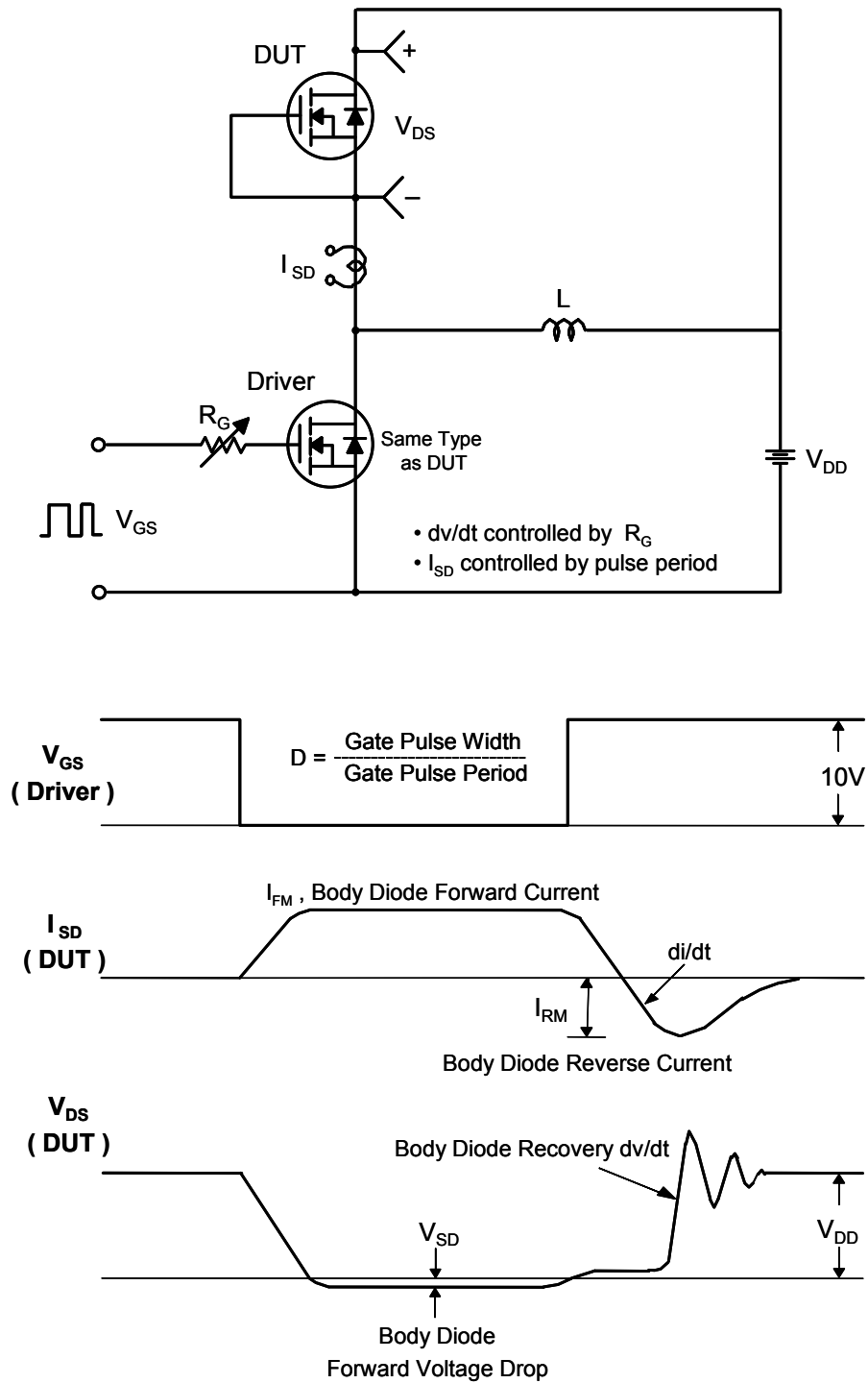
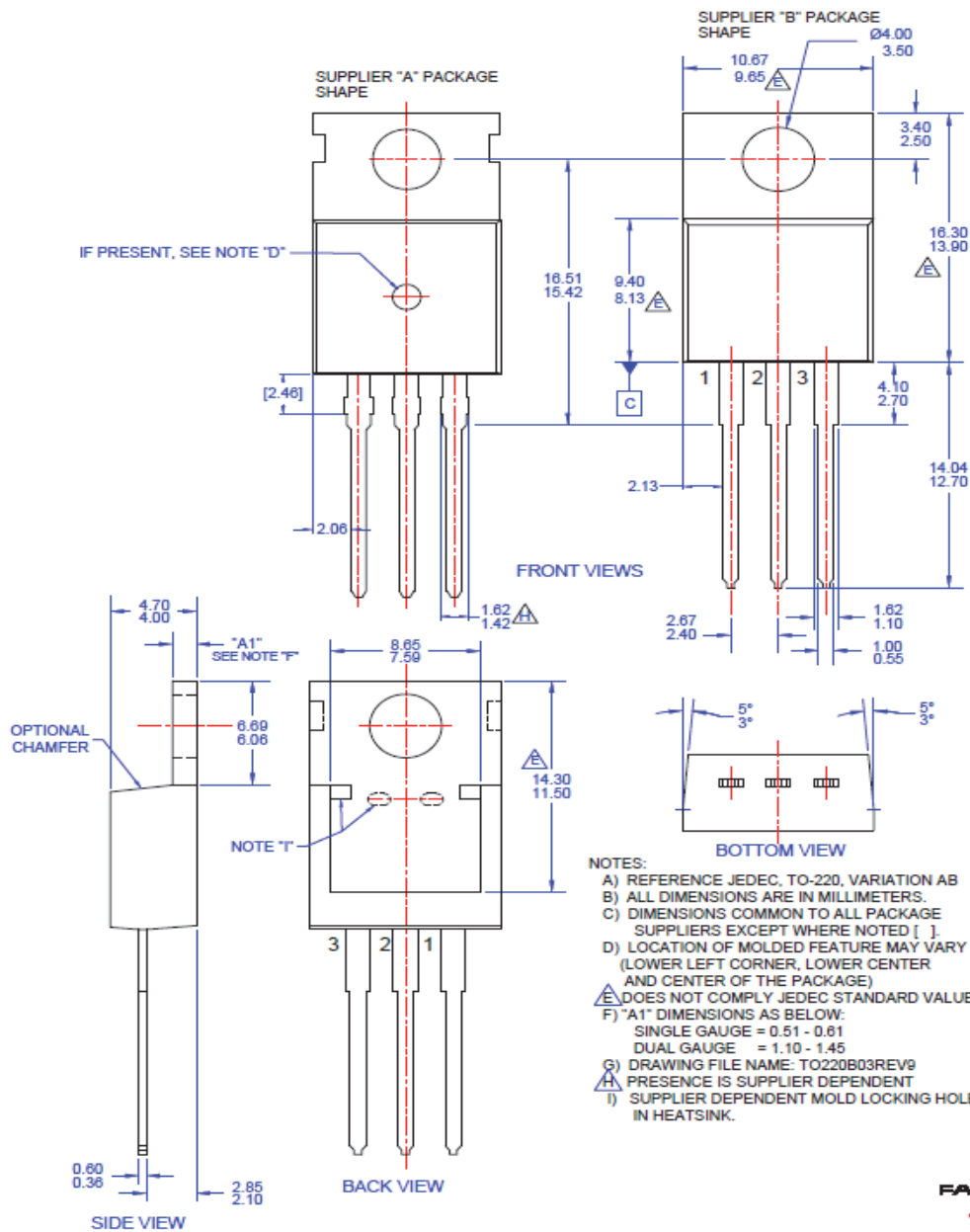

Figure 17. Peak Diode Recovery dv/dt Test Circuit & Waveforms



Mechanical Dimensions

TO-220 3L



- NOTES:
- A) REFERENCE JEDEC, TO-220, VARIATION AB
 - B) ALL DIMENSIONS ARE IN MILLIMETERS.
 - C) DIMENSIONS COMMON TO ALL PACKAGE SUPPLIERS EXCEPT WHERE NOTED [].
 - D) LOCATION OF MOLDED FEATURE MAY VARY (LOWER LEFT CORNER, LOWER CENTER AND CENTER OF THE PACKAGE)
 - E) DOES NOT COMPLY JEDEC STANDARD VALUE.
 - F) "A1" DIMENSIONS AS BELOW:
SINGLE GAUGE = 0.51 - 0.61
DUAL GAUGE = 1.10 - 1.45
 - G) DRAWING FILE NAME: TO220B03REV9
 - H) PRESENCE IS SUPPLIER DEPENDENT
 - I) SUPPLIER DEPENDENT MOLD LOCKING HOLES IN HEATSINK.



Mechanical Dimensions

TO-220F 3L

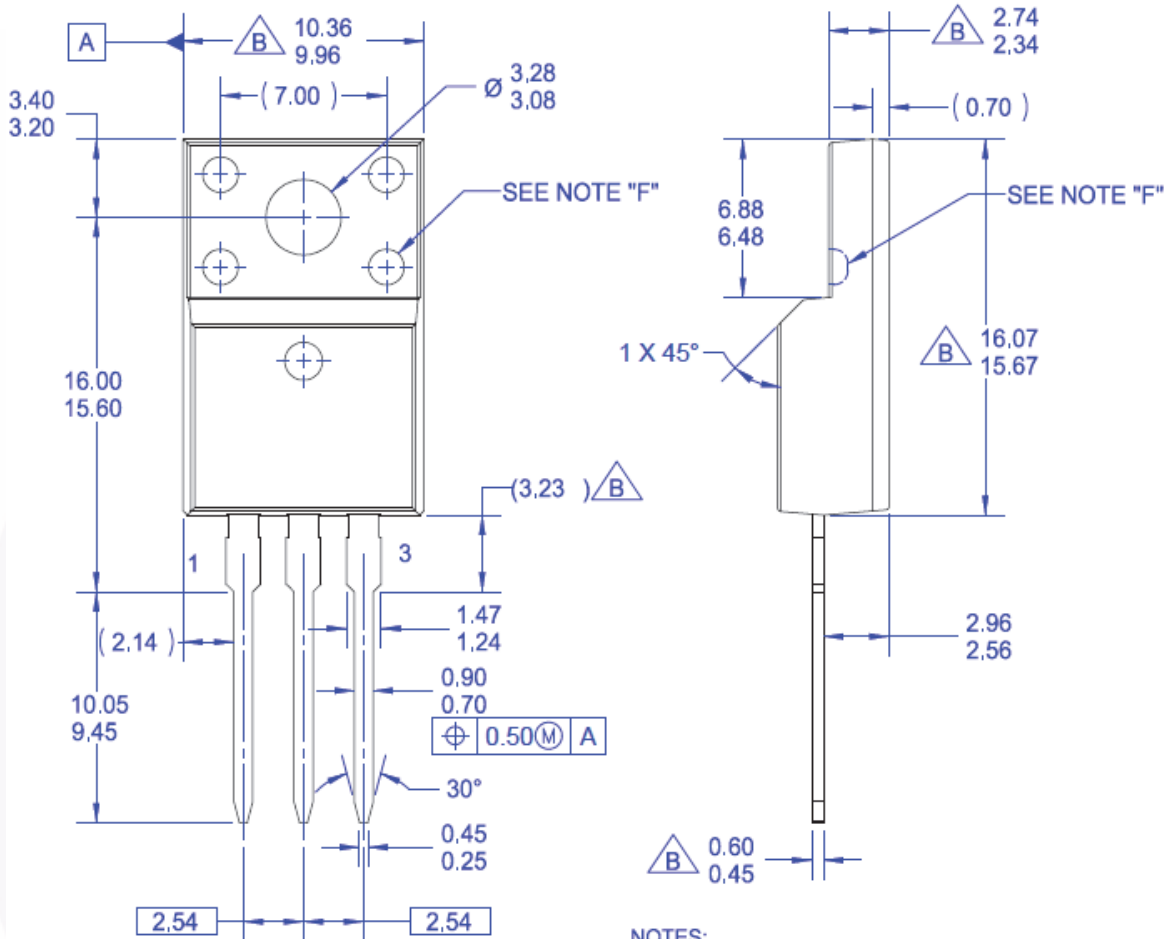

NOTES:





- A. EXCEPT WHERE NOTED CONFORMS TO EIAJ SC91A.
- B. DOES NOT COMPLY EIAJ STD. VALUE.
- C. ALL DIMENSIONS ARE IN MILLIMETERS.
- D. DIMENSIONS ARE EXCLUSIVE OF BURRS, MOLD FLASH AND TIE BAR PROTRUSIONS.
- E. DIMENSION AND TOLERANCE AS PER ASME Y14.5-1994.
- F. OPTION 1 - WITH SUPPORT PIN HOLE.
OPTION 2 - NO SUPPORT PIN HOLE.
- G. DRAWING FILE NAME: TO220M03REV4





TRADEMARKS

The following includes registered and unregistered trademarks and service marks, owned by Fairchild Semiconductor and/or its global subsidiaries, and is not intended to be an exhaustive list of all such trademarks.

- | | | | |
|---|---|---|---|
| AccuPower™ | F-PFS™ | OPTOPLANAR® | |
| AttitudeEngine™ | FRFET® |  | |
| Awinda® | Global Power Resource™ | |  |
| AX-CAP®* | GreenBridge™ | Power Supply WebDesigner™ | TinyBoost® |
| BitSiC™ | Green FPS™ | PowerTrench® | TinyBuck® |
| Build it Now™ | Green FPS™ e-Series™ | PowerXS™ | TinyCalc™ |
| CorePLUS™ | Gmax™ | Programmable Active Droop™ | TinyLogic® |
| CorePOWER™ | GTO™ | QFET® | TINYOPTO™ |
| CROSSVOLT™ | IntelliMAX™ | QS™ | TinyPower™ |
| CTL™ | ISOPLANAR™ | Quiet Series™ | TinyPWM™ |
| Current Transfer Logic™ | Marking Small Speakers Sound Louder and Better™ | RapidConfigure™ | TinyWire™ |
| DEUXPEED® | MegaBuck™ |  | TransSiC™ |
| Dual Cool™ | MICROCOUPLER™ | Saving our world, 1mW/W/kW at a time™ | TriFault Detect™ |
| EcoSPARK® | MicroFET™ | SignalWise™ | TRUECURRENT®* |
| EfficientMax™ | MicroPak™ | SmartMax™ | µSerDes™ |
| ESBC™ | MicroPak2™ | SMART START™ |  |
|  | MillerDrive™ | Solutions for Your Success™ | UHC® |
| Fairchild® | MotionMax™ | SPM® | Ultra FRFET™ |
| Fairchild Semiconductor® | MotionGrid® | STEALTH™ | UniFET™ |
| FACT Quiet Series™ | MTI® | SuperFET® | VCX™ |
| FACT® | MTx® | SuperSOT™-3 | VisualMax™ |
| FastvCore™ | MVN® | SuperSOT™-6 | VoltagePlus™ |
| FETBench™ | mWSaver® | SuperSOT™-8 | XS™ |
| FPS™ | OptoHiT™ | SupreMOS® | Xsens™ |
| | OPTOLOGIC® | SyncFET™ | 仙童® |
| | | Sync-Lock™ | |

*Trademarks of System General Corporation, used under license by Fairchild Semiconductor.

DISCLAIMER

FAIRCHILD SEMICONDUCTOR RESERVES THE RIGHT TO MAKE CHANGES WITHOUT FURTHER NOTICE TO ANY PRODUCTS HEREIN TO IMPROVE RELIABILITY, FUNCTION, OR DESIGN. TO OBTAIN THE LATEST, MOST UP-TO-DATE DATASHEET AND PRODUCT INFORMATION, VISIT OUR WEBSITE AT <http://www.fairchildsemi.com>. FAIRCHILD DOES NOT ASSUME ANY LIABILITY ARISING OUT OF THE APPLICATION OR USE OF ANY PRODUCT OR CIRCUIT DESCRIBED HEREIN; NEITHER DOES IT CONVEY ANY LICENSE UNDER ITS PATENT RIGHTS, NOR THE RIGHTS OF OTHERS. THESE SPECIFICATIONS DO NOT EXPAND THE TERMS OF FAIRCHILD'S WORLDWIDE TERMS AND CONDITIONS, SPECIFICALLY THE WARRANTY THEREIN, WHICH COVERS THESE PRODUCTS.

AUTHORIZED USE

Unless otherwise specified in this data sheet, this product is a standard commercial product and is not intended for use in applications that require extraordinary levels of quality and reliability. This product may not be used in the following applications, unless specifically approved in writing by a Fairchild officer: (1) automotive or other transportation, (2) military/aerospace, (3) any safety critical application – including life critical medical equipment – where the failure of the Fairchild product reasonably would be expected to result in personal injury, death or property damage. Customer's use of this product is subject to agreement of this Authorized Use policy. In the event of an unauthorized use of Fairchild's product, Fairchild accepts no liability in the event of product failure. In other respects, this product shall be subject to Fairchild's Worldwide Terms and Conditions of Sale, unless a separate agreement has been signed by both Parties.

ANTI-COUNTERFEITING POLICY

Fairchild Semiconductor Corporation's Anti-Counterfeiting Policy. Fairchild's Anti-Counterfeiting Policy is also stated on our external website, www.fairchildsemi.com, under Terms of Use

Counterfeiting of semiconductor parts is a growing problem in the industry. All manufacturers of semiconductor products are experiencing counterfeiting of their parts. Customers who inadvertently purchase counterfeit parts experience many problems such as loss of brand reputation, substandard performance, failed applications, and increased cost of production and manufacturing delays. Fairchild is taking strong measures to protect ourselves and our customers from the proliferation of counterfeit parts. Fairchild strongly encourages customers to purchase Fairchild parts either directly from Fairchild or from Authorized Fairchild Distributors who are listed by country on our web page cited above. Products customers buy either from Fairchild directly or from Authorized Fairchild Distributors are genuine parts, have full traceability, meet Fairchild's quality standards for handling and storage and provide access to Fairchild's full range of up-to-date technical and product information. Fairchild and our Authorized Distributors will stand behind all warranties and will appropriately address and warranty issues that may arise. Fairchild will not provide any warranty coverage or other assistance for parts bought from Unauthorized Sources. Fairchild is committed to combat this global problem and encourage our customers to do their part in stopping this practice by buying direct or from authorized distributors.

PRODUCT STATUS DEFINITIONS

Definition of Terms

Datasheet Identification	Product Status	Definition
Advance Information	Formative / In Design	Datasheet contains the design specifications for product development. Specifications may change in any manner without notice.
Preliminary	First Production	Datasheet contains preliminary data; supplementary data will be published at a later date. Fairchild Semiconductor reserves the right to make changes at any time without notice to improve design.
No Identification Needed	Full Production	Datasheet contains final specifications. Fairchild Semiconductor reserves the right to make changes at any time without notice to improve the design.
Obsolete	Not In Production	Datasheet contains specifications on a product that is discontinued by Fairchild Semiconductor. The datasheet is for reference information only.

ON Semiconductor and  are trademarks of Semiconductor Components Industries, LLC dba ON Semiconductor or its subsidiaries in the United States and/or other countries. ON Semiconductor owns the rights to a number of patents, trademarks, copyrights, trade secrets, and other intellectual property. A listing of ON Semiconductor's product/patent coverage may be accessed at www.onsemi.com/site/pdf/Patent-Marking.pdf. ON Semiconductor reserves the right to make changes without further notice to any products herein. ON Semiconductor makes no warranty, representation or guarantee regarding the suitability of its products for any particular purpose, nor does ON Semiconductor assume any liability arising out of the application or use of any product or circuit, and specifically disclaims any and all liability, including without limitation special, consequential or incidental damages. Buyer is responsible for its products and applications using ON Semiconductor products, including compliance with all laws, regulations and safety requirements or standards, regardless of any support or applications information provided by ON Semiconductor. "Typical" parameters which may be provided in ON Semiconductor data sheets and/or specifications can and do vary in different applications and actual performance may vary over time. All operating parameters, including "Typicals" must be validated for each customer application by customer's technical experts. ON Semiconductor does not convey any license under its patent rights nor the rights of others. ON Semiconductor products are not designed, intended, or authorized for use as a critical component in life support systems or any FDA Class 3 medical devices or medical devices with a same or similar classification in a foreign jurisdiction or any devices intended for implantation in the human body. Should Buyer purchase or use ON Semiconductor products for any such unintended or unauthorized application, Buyer shall indemnify and hold ON Semiconductor and its officers, employees, subsidiaries, affiliates, and distributors harmless against all claims, costs, damages, and expenses, and reasonable attorney fees arising out of, directly or indirectly, any claim of personal injury or death associated with such unintended or unauthorized use, even if such claim alleges that ON Semiconductor was negligent regarding the design or manufacture of the part. ON Semiconductor is an Equal Opportunity/Affirmative Action Employer. This literature is subject to all applicable copyright laws and is not for resale in any manner.

PUBLICATION ORDERING INFORMATION

LITERATURE FULFILLMENT:

Literature Distribution Center for ON Semiconductor
19521 E. 32nd Pkwy, Aurora, Colorado 80011 USA
Phone: 303-675-2175 or 800-344-3860 Toll Free USA/Canada
Fax: 303-675-2176 or 800-344-3867 Toll Free USA/Canada
Email: orderlit@onsemi.com

N. American Technical Support: 800-282-9855 Toll Free
USA/Canada
Europe, Middle East and Africa Technical Support:
Phone: 421 33 790 2910
Japan Customer Focus Center
Phone: 81-3-5817-1050

ON Semiconductor Website: www.onsemi.com
Order Literature: <http://www.onsemi.com/orderlit>
For additional information, please contact your local
Sales Representative

Looking for pricing, stock, or lifecycle information?

Click below to explore more details on WIN SOURCE:

-  [View FDPF12N50NZT on WIN SOURCE](#)
-  [Fairchild/ON Semiconductor Information](#)

Optimize Your Supply Chain with WIN SOURCE Solutions

-  Global Sourcing Solution
-  Obsolete Management
-  Cost Control Management
-  Shortage Management
-  Alternative Solution
-  Excess Inventory Management