

Description

The ZMR series of three terminal fixed positive voltage regulators feature internal current limit and will shut down under thermal overload conditions making the devices difficult to destroy.

The circuit design offers an exceptionally low quiescent current, only 30µA for the 2.5V device, ideal for low power applications. The initial devices in the series regulate to 2.5 or 5V with a drive capability up to 50mA.

The device is designed with space saving in mind and is available in the small outline SOT23 package. The ZMR250 has expanded its input voltage range to 22.5V and the ZMR500 has expanded its input voltage range to 25V; equaling that of the ZMR25H and ZMR50H respectively.

The ZMR330 provides a 3.3V output over an input range of 5V to 24V.

Features

- Small Outline SOT23 Package
- 2.5V, 3.3V and 5V Output
- Output Current up to 50mA
- Very Low Quiescent Current (30µA)
- Unconditionally Stable
- Internal Short Circuit Current Limit
- **Totally Lead-Free & Fully RoHS Compliant (Notes 1 & 2)**
- **Halogen and Antimony Free. "Green" Device (Note 3)**

- Notes:
1. No purposely added lead. Fully EU Directive 2002/95/EC (RoHS) & 2011/65/EU (RoHS 2) compliant.
 2. See <http://www.diodes.com> for more information about Diodes Incorporated's definitions of Halogen- and Antimony-free, "Green" and Lead-free.
 3. Halogen- and Antimony-free "Green" products are defined as those which contain <900ppm bromine, <900ppm chlorine (<1500ppm total Br + Cl) and < 1000 ppm antimony compounds.

Pin Assignments

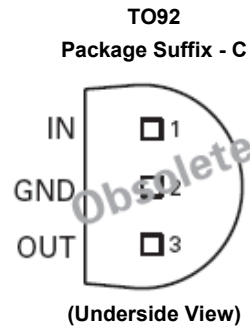
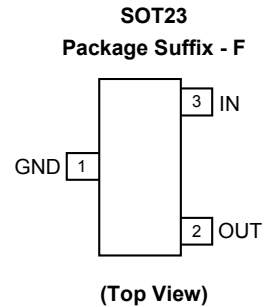

Applications

- Consumer Electronics
- DVD/Blu-Ray Player, CD-ROM, Set Top Box
- TV, Monitor, Security System
- Supply for Low Power Microcontroller
- Local Low Current Supply within Larger Systems

Equivalent Circuit

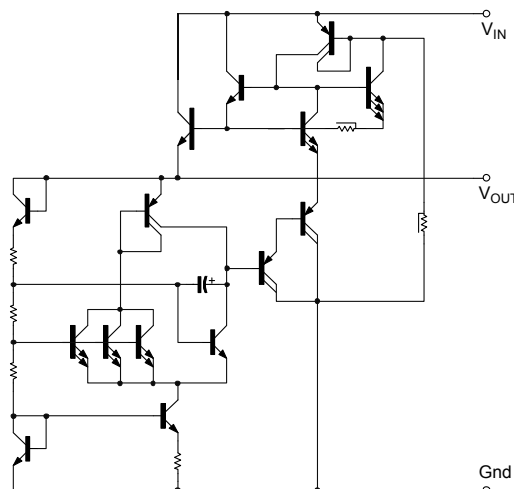

Absolute Maximum Ratings (@T_A = +25°C, unless otherwise specified.)

Parameter	Rating	Unit
Input Voltage		
ZMR250	22.5	V
ZMR330	24	
ZMR500	25	
Power Dissipation (T _{AMB} = +25°C) (Note 6)		
SOT23	500	mW
Output Current (I _O)	100	mA
Ambient Temperature	-55 to +125	°C
Maximum Junction Temperature	125	°C
Storage Temperature	-65 to +150	°C

- Notes:
- The maximum operating input voltage and output current of the device will be governed by the maximum power dissipation of the selected package. Maximum package power dissipation is specified at 25°C and must be linearly derated to zero at T_{AMB} = +125°C.
 - The following data represents pulse test conditions with junction temperatures as indicated at the initiation of the test. Continuous operation of the devices with the stated conditions might exceed the power dissipation limits of the chosen package.
 - Maximum power dissipation for the SOT23 package, is calculated assuming that the device is mounted on a ceramic substrate measuring 15x15x0.6mm.

Recommended Operating Conditions (@T_A = +25°C, unless otherwise specified.)

Input Voltage Range	Min	Max	Unit
ZMR250	4.2	22.5	V
ZMR330	4.8	24	V
ZMR500	7.0	25	V

Electrical Characteristics (@T_A = +25°C, I_O = 10mA, V_{IN} = 6.5V, unless otherwise specified.)

ZMR250

Symbol	Parameter	Condition	Min	Typ	Max	Unit
V _O	Output Voltage		2.438	2.5	2.563	V
		I _O = 0 to 50mA T _J = -55°C to +125°C	2.360		2.640	V
		V _{IN} = 4.5 to 22.5V I _O = 0 to 50mA T _J = -55°C to +125°C	2.630		2.640	V
ΔV _O	Line Regulation	V _{IN} = 4.5 to 22.5V		5	15	mV
ΔV _O	Load Regulation	I _O = 0 to 50mA I _O = 0 to 10mA		20 12	30	mV
I _S	Supply Current	T _J = -55°C to +125°C		30	40	μA
ΔI _S	Supply Current Change	I _O = 0 to 50mA V _{IN} = 4.5 to 22.5V		1 2	±10 10	μA
V _N	Output Noise Voltage	f = 10Hz to 10kHz		65		μVrms
ΔV _{IN} /ΔV _O	Ripple Rejection	V _{IN} = 6.3 to 18V f = 120Hz	55	75		dB
V _{IN}	Input Voltage Required to Maintain Regulation			3.9		V
ΔV _O /ΔT	Average Temperature Coefficient V _O	I _O = 5.0mA T _J = -55°C to +125°C		0.275	0.700	mV/°C

Electrical Characteristics (@ $T_A = +25^\circ\text{C}$, $I_O = 10\text{mA}$, $V_{IN} = 7\text{V}$, unless otherwise specified.)

ZMR330

Symbol	Parameter	Condition	Min	Typ	Max	Unit
V_O	Output Voltage		3.217	3.3	3.383	V
		$I_O = 0$ to 50mA $T_J = -55^\circ\text{C}$ to $+125^\circ\text{C}$	3.148		3.393	V
		$V_{IN} = 5$ to 24V $I_O = 0$ to 50mA $T_J = -55^\circ\text{C}$ to $+125^\circ\text{C}$	3.148		3.408	V
ΔV_O	Line Regulation	$V_{IN} = 5$ to 24V		5	15	mV
ΔV_O	Load Regulation	$I_O = 0$ to 50mA $I_O = 0$ to 10mA		20 13	30	mV
I_S	Supply Current	$T_J = -55^\circ\text{C}$ to $+125^\circ\text{C}$		120	170	μA
ΔI_S	Supply Current Change	$I_O = 0$ to 50mA $V_{IN} = 5$ to 20V		5 2	10 10	μA
V_N	Output Noise Voltage	$f = 10\text{Hz}$ to 10kHz		80		μVrms
$\Delta V_{IN}/\Delta V_O$	Ripple Rejection	$V_{IN} = 6$ to 20V $f = 120\text{Hz}$	55			dB
V_{IN}	Input Voltage Required to Maintain Regulation			4.74		V

Electrical Characteristics (@ $T_A = +25^\circ\text{C}$, $I_O = 10\text{mA}$, $V_{IN} = 10\text{V}$, unless otherwise specified.)

ZMR500

Symbol	Parameter	Condition	Min	Typ	Max	Unit
V_O	Output Voltage		4.785	5	5.125	V
		$I_O = 0$ to 50mA $T_J = -55^\circ\text{C}$ to $+125^\circ\text{C}$	4.780		5.160	V
		$V_{IN} = 7$ to 25V $I_O = 0$ to 50mA $T_J = -55^\circ\text{C}$ to $+125^\circ\text{C}$	4.780		5.175	V
ΔV_O	Line Regulation	$V_{IN} = 7$ to 25V		5	15	mV
ΔV_O	Load Regulation	$I_O = 0$ to 50mA $I_O = 0$ to 10mA		25 15	40	mV
I_S	Supply Current	$T_J = -55^\circ\text{C}$ to $+125^\circ\text{C}$		50	70	μA
ΔI_S	Supply Current Change	$I_O = 0$ to 50mA $V_{IN} = 7$ to 25V		1 2	± 10 10	μA
V_N	Output Noise Voltage	$f = 10\text{Hz}$ to 10kHz		90		μVrms
$\Delta V_{IN}/\Delta V_O$	Ripple Rejection	$V_{IN} = 8$ to 18V $f = 120\text{Hz}$	55	72		dB
V_{IN}	Input Voltage Required to Maintain Regulation			6.2		V
$\Delta V_O/\Delta T$	Average Temperature Coefficient V_O	$I_O = 5.0\text{mA}$ $T_J = -55^\circ\text{C}$ to $+125^\circ\text{C}$		0.275	0.700	$\text{mV}/^\circ\text{C}$

Typical Characteristics

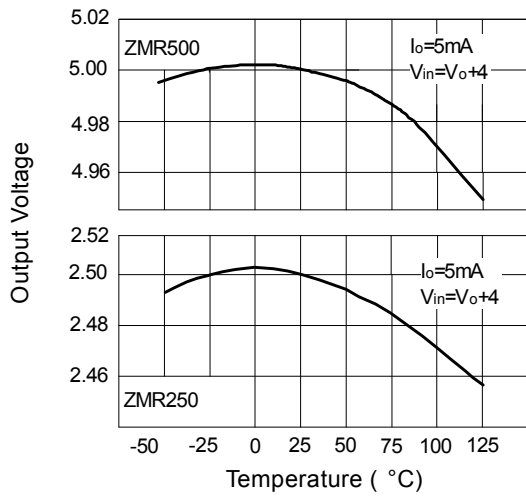

Output Voltage Temperature

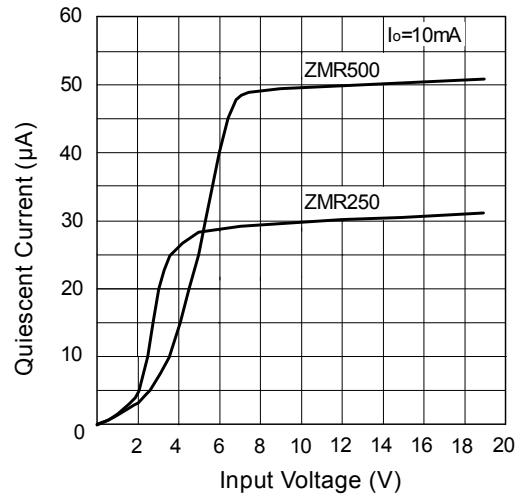

Quiescent Current v Voltage

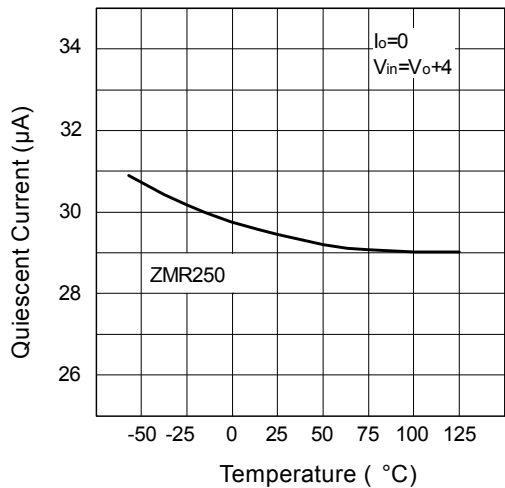

Quiescent Current v Temperature

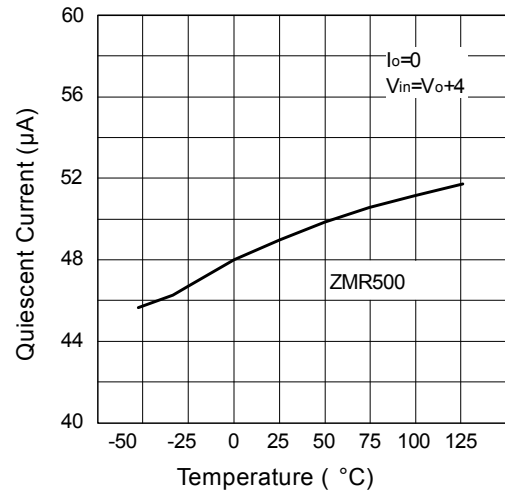

Quiescent Current v Temperature

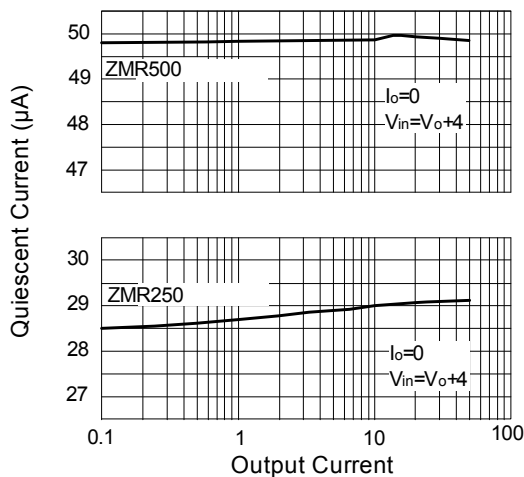

Quiescent Current v Output Current

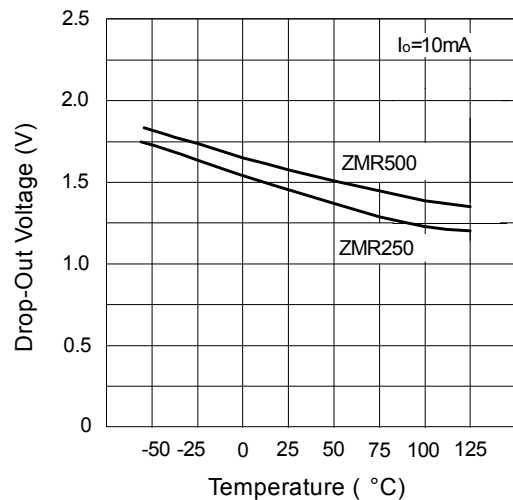

Drop-Out Voltage v Temperature

Typical Characteristics (cont.)

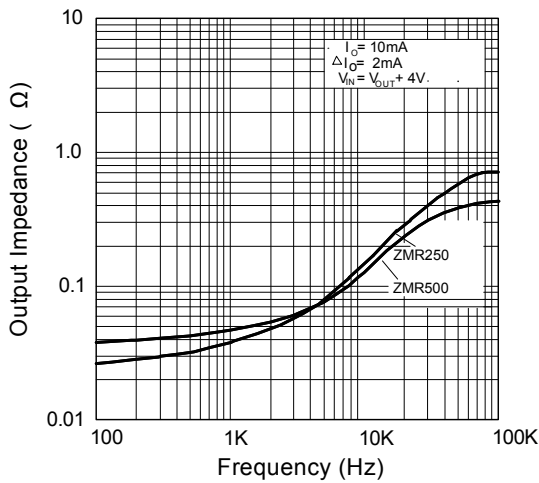

Output Impedance v Frequency

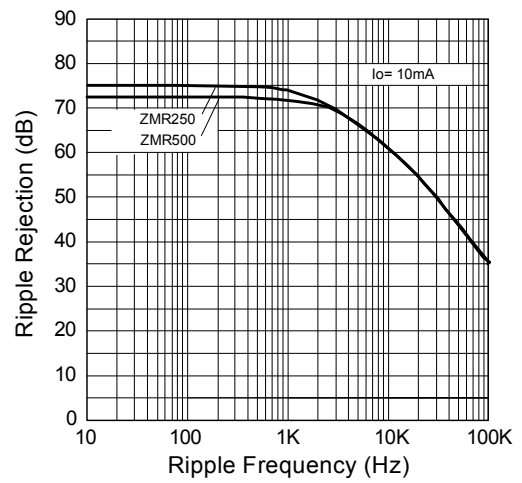

Ripple Rejection v Ripple Frequency

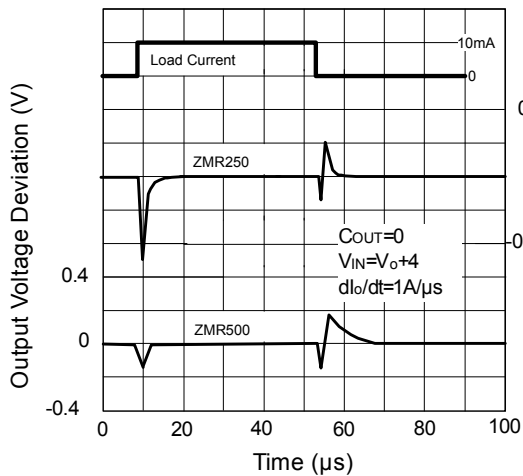

Load Transient Response

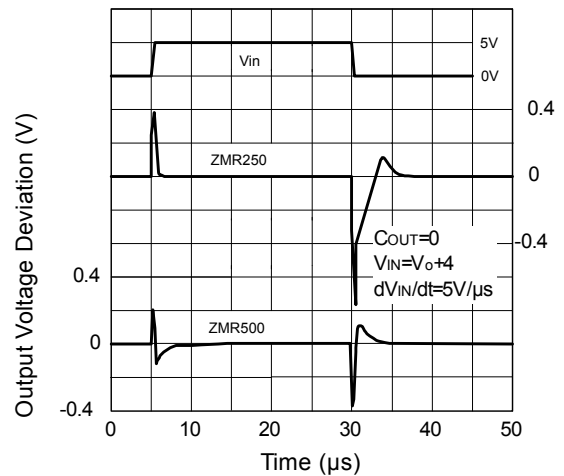

Line Transient Response

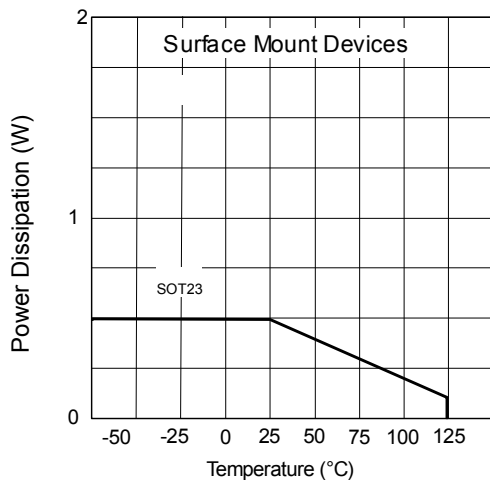

Power Derating

Ordering Information

Part Number	Package	Part Mark	Status	Reel Size (inches)	Quantity per reel	Tape Width (mm)
ZMR25HFTA	SOT23	25X	Obsolete replaced by ZMR250FTA	7"	3000	8mm
ZMR50HFTA	SOT23	50R	Obsolete replaced by ZMR500FTA	7"	3000	8mm
ZMR250FTA	SOT23	25K	Released	7"	3000	8mm
ZMR330FTA	SOT23	330	Released	7"	3000	8mm
ZMR330F-7*	SOT23	330	Released	7"	3000	8mm
ZMR500FTA	SOT23	50K	Released	7"	3000	8mm



* All TO92 variants (ZMRxxxC) are obsolete. Closest replacements are the ZMRxxxFTA.

Package Outline Dimensions (All dimensions in mm.)

Please see AP02002 at <http://www.diodes.com/datasheets/ap02002.pdf> for latest version.

SOT23

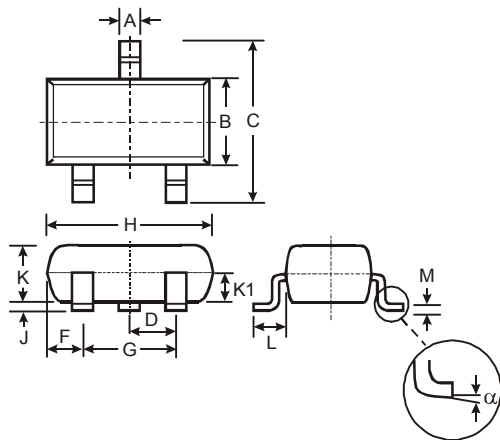

SOT23			
Dim	Min	Max	Typ
A	0.37	0.51	0.40
B	1.20	1.40	1.30
C	2.30	2.50	2.40
D	0.89	1.03	0.915
F	0.45	0.60	0.535
G	1.78	2.05	1.83
H	2.80	3.00	2.90
J	0.013	0.10	0.05
K	0.903	1.10	1.00
K1	-	-	0.400
L	0.45	0.61	0.55
M	0.085	0.18	0.11
α	0°	8°	-

All Dimensions in mm

TO92

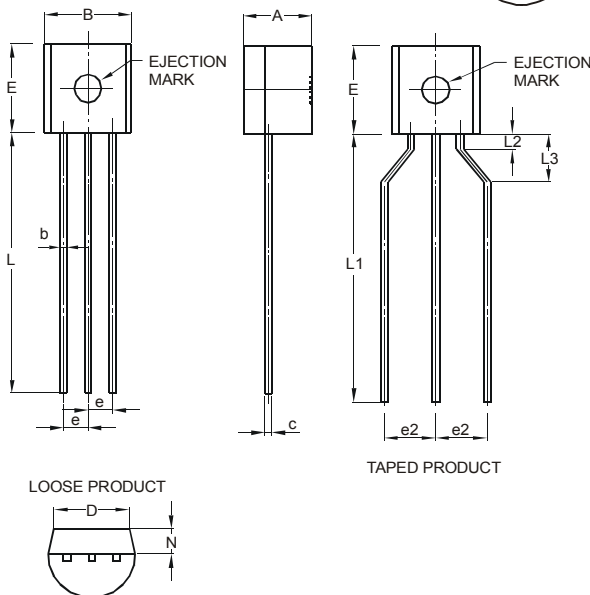

TO92			
Dim	Min	Max	Typ
A	3.45	3.66	—
B	4.27	4.78	—
b	—	—	0.38
c	—	—	0.38
D	—	—	3.87
E	4.32	4.83	—
e	—	—	1.27
e2	2.40	2.90	—
L	12.98	15.00	—
L1	12.80	15.00	—
L2	0.80	-	—
L3	2.00	3.00	—
N	1.22	1.37	—

All Dimensions in mm

Suggested Pad Layout

Please see AP02001 at <http://www.diodes.com/datasheets/ap02001.pdf> for the latest version.

SOT23

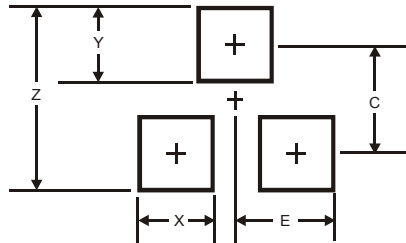

Dimensions	Value (in mm)
Z	2.9
X	0.8
Y	0.9
C	2.0
E	1.35

IMPORTANT NOTICE

DIODES INCORPORATED MAKES NO WARRANTY OF ANY KIND, EXPRESS OR IMPLIED, WITH REGARDS TO THIS DOCUMENT, INCLUDING, BUT NOT LIMITED TO, THE IMPLIED WARRANTIES OF MERCHANTABILITY AND FITNESS FOR A PARTICULAR PURPOSE (AND THEIR EQUIVALENTS UNDER THE LAWS OF ANY JURISDICTION).

Diodes Incorporated and its subsidiaries reserve the right to make modifications, enhancements, improvements, corrections or other changes without further notice to this document and any product described herein. Diodes Incorporated does not assume any liability arising out of the application or use of this document or any product described herein; neither does Diodes Incorporated convey any license under its patent or trademark rights, nor the rights of others. Any Customer or user of this document or products described herein in such applications shall assume all risks of such use and will agree to hold Diodes Incorporated and all the companies whose products are represented on Diodes Incorporated website, harmless against all damages.

Diodes Incorporated does not warrant or accept any liability whatsoever in respect of any products purchased through unauthorized sales channel. Should Customers purchase or use Diodes Incorporated products for any unintended or unauthorized application, Customers shall indemnify and hold Diodes Incorporated and its representatives harmless against all claims, damages, expenses, and attorney fees arising out of, directly or indirectly, any claim of personal injury or death associated with such unintended or unauthorized application.

Products described herein may be covered by one or more United States, international or foreign patents pending. Product names and markings noted herein may also be covered by one or more United States, international or foreign trademarks.

This document is written in English but may be translated into multiple languages for reference. Only the English version of this document is the final and determinative format released by Diodes Incorporated.

LIFE SUPPORT

Diodes Incorporated products are specifically not authorized for use as critical components in life support devices or systems without the express written approval of the Chief Executive Officer of Diodes Incorporated. As used herein:

A. Life support devices or systems are devices or systems which:

1. are intended to implant into the body, or
2. support or sustain life and whose failure to perform when properly used in accordance with instructions for use provided in the labeling can be reasonably expected to result in significant injury to the user.

B. A critical component is any component in a life support device or system whose failure to perform can be reasonably expected to cause the failure of the life support device or to affect its safety or effectiveness.

Customers represent that they have all necessary expertise in the safety and regulatory ramifications of their life support devices or systems, and acknowledge and agree that they are solely responsible for all legal, regulatory and safety-related requirements concerning their products and any use of Diodes Incorporated products in such safety-critical, life support devices or systems, notwithstanding any devices- or systems-related information or support that may be provided by Diodes Incorporated. Further, Customers must fully indemnify Diodes Incorporated and its representatives against any damages arising out of the use of Diodes Incorporated products in such safety-critical, life support devices or systems.

Copyright © 2013, Diodes Incorporated

www.diodes.com

Looking for pricing, stock, or lifecycle information?

Click below to explore more details on WIN SOURCE:

 [View ZMR330F-7 on WIN SOURCE](#)

 [Diodes Incorporated](#) Information

Optimize Your Supply Chain with WIN SOURCE Solutions

-  Global Sourcing Solution
-  Obsolete Management
-  Cost Control Management
-  Shortage Management
-  Alternative Solution
-  Excess Inventory Management