



**THE DATASHEET OF
IRC830PBF**



HEXFET® Power MOSFET

- Dynamic dv/dt Rating
- Repetitive Avalanche Rated
- Current Sense
- Fast Switching
- Ease of Paralleling
- Simple Drive Requirements

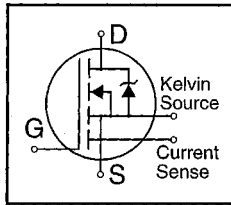

$$V_{DSS} = 500V$$

$$R_{DS(on)} = 1.5\Omega$$

$$I_D = 4.5A$$

Description

Third Generation HEXFETs from International Rectifier provide the designer with the best combination of fast switching, ruggedized device design, low on-resistance and cost-effectiveness.

The HEXSense device provides an accurate fraction of the drain current through the additional two leads to be used for control or protection of the device. These devices exhibit similar electrical and thermal characteristics as their IRF-series equivalent part numbers. The provision of a kelvin source connection effectively eliminates problems of common source inductance when the HEXSense is used as a fast, high-current switch in non current-sensing applications.

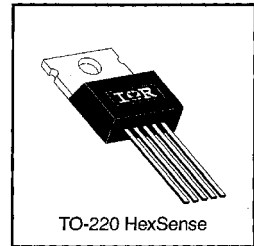

DATA SHEETS

Absolute Maximum Ratings

| | Parameter | Max. | Units |
|---------------------------|---|---------------------|-------|
| $I_D @ T_C = 25^\circ C$ | Continuous Drain Current, $V_{GS} @ 10 V$ | 4.5 | A |
| $I_D @ T_C = 100^\circ C$ | Continuous Drain Current, $V_{GS} @ 10 V$ | 3.0 | |
| I_{DM} | Pulsed Drain Current ① | 18 | |
| $P_D @ T_C = 25^\circ C$ | Power Dissipation | 74 | W |
| | Linear Derating Factor | 0.59 | W/°C |
| V_{GS} | Gate-to-Source Voltage | ± 20 | V |
| E_{AS} | Single Pulse Avalanche Energy ② | 280 | mJ |
| I_{AR} | Avalanche Current ① | 4.5 | A |
| E_{AR} | Repetitive Avalanche Energy ① | 7.4 | mJ |
| dv/dt | Peak Diode Recovery dv/dt ③ | 3.5 | V/ns |
| T_J | Operating Junction and | -55 to +150 | °C |
| T_{STG} | Storage Temperature Range | | |
| | Soldering Temperature, for 10 seconds | | |
| | Mounting Torque, 6-32 or M3 screw | 10 lbf•in (1.1 N•m) | |

Thermal Resistance

| | Parameter | Min. | Typ. | Max. | Units |
|-----------------|-------------------------------------|------|------|------|-------|
| $R_{\theta JC}$ | Junction-to-Case | — | — | 1.7 | °C/W |
| $R_{\theta CS}$ | Case-to-Sink, Flat, Greased Surface | — | 0.50 | — | |
| $R_{\theta JA}$ | Junction-to-Ambient | — | — | 62 | |

Electrical Characteristics @ T_J = 25°C (unless otherwise specified)

| | Parameter | Min. | Typ. | Max. | Units | Test Conditions |
|--------------------------------------|--------------------------------------|------|------|------|-------|---|
| V _{(BR)DSS} | Drain-to-Source Breakdown Voltage | 500 | — | — | V | V _{GS} =0V, I _D =250μA |
| ΔV _{(BR)DSS/ΔT_J} | Breakdown Voltage Temp. Coefficient | — | 0.61 | — | V/°C | Reference to 25°C, I _D =1mA |
| R _{DS(on)} | Static Drain-to-Source On-Resistance | — | — | 1.5 | Ω | V _{GS} =10V, I _D =2.7A ④ |
| V _{GS(th)} | Gate Threshold Voltage | 2.0 | — | 4.0 | V | V _{DS} =V _{GS} , I _D =250μA |
| g _{fs} | Forward Transconductance | 2.7 | — | — | S | V _{DS} =50V, I _D =2.7A ④ |
| I _{DSS} | Drain-to-Source Leakage Current | — | — | 25 | μA | V _{DS} =500V, V _{GS} =0V |
| | | — | — | 250 | | V _{DS} =400V, V _{GS} =0V, T _J =125°C |
| I _{GSS} | Gate-to-Source Forward Leakage | — | — | 100 | nA | V _{GS} =20V |
| | Gate-to-Source Reverse Leakage | — | — | -100 | | V _{GS} =-20V |
| Q _g | Total Gate Charge | — | — | 38 | nC | I _D =3.1A |
| Q _{gs} | Gate-to-Source Charge | — | — | 5.0 | | V _{DS} =400V |
| Q _{gd} | Gate-to-Drain ("Miller") Charge | — | — | 22 | | V _{GS} =10V See Fig. 6 and 13 ④ |
| t _{d(on)} | Turn-On Delay Time | — | 8.2 | — | ns | V _{DD} =250V |
| t _r | rise Time | — | 16 | — | | I _D =3.1A |
| t _{d(off)} | Turn-Off Delay Time | — | 42 | — | | R _G =12Ω |
| t _f | Fall Time | — | 16 | — | | R _D =79Ω See Figure 10 ④ |
| L _D | Internal Drain Inductance | — | 4.5 | — | nH | Between lead, 6 mm (0.25in.) from package and center of die contact |
| L _S | Internal Source Inductance | — | 7.5 | — | | |
| C _{ISS} | Input Capacitance | — | 610 | — | pF | V _{GS} =0V |
| C _{OSS} | Output Capacitance | — | 91 | — | | V _{DS} =25V |
| C _{RSS} | Reverse Transfer Capacitance | — | 68 | — | | f=1.0MHz See Figure 5 |
| r | Current Sensing Ratio | 1440 | — | 1600 | — | I _D =4.5A, V _{GS} =10V |
| C _{OSS} | Output Capacitance of Sensing Cells | — | 9.0 | — | pF | V _{GS} =0V, V _{DS} =25V, f=1.0MHz |

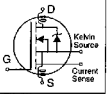

Source-Drain Ratings and Characteristics

| | Parameter | Min. | Typ. | Max. | Units | Test Conditions |
|-----------------|--|--|------|------|-------|---|
| I _S | Continuous Source Current (Body Diode) | — | — | 4.5 | A | MOSFET symbol showing the integral reverse p-n junction diode. |
| I _{SM} | Pulsed Source Current (Body Diode) ① | — | — | 18 | | |
| V _{SD} | Diode Forward Voltage | — | — | 1.6 | V | T _J =25°C, I _S =4.5A, V _{GS} =0V ④ |
| t _{rr} | Reverse Recovery Time | — | 320 | 640 | ns | T _J =25°C, I _F =3.1A |
| Q _{rr} | Reverse Recovery Charge | — | 1.0 | 2.0 | μC | di/dt=100A/μs ④ |
| t _{on} | Forward Turn-On Time | Intrinsic turn-on time is negligible (turn-on is dominated by L _S +L _D) | | | | |

Notes:

- ① Repetitive rating; pulse width limited by max. junction temperature (See Figure 11)
- ② V_{DD}=50V, starting T_J=25°C, L=24mH R_G=25Ω, I_{AS}=4.5A (See Figure 12)
- ③ I_{SD}≤4.5A, di/dt≤75A/μs, V_{DD}≤V_{(BR)DSS}, T_J≤150°C
- ④ Pulse width ≤ 300 μs; duty cycle ≤2%.

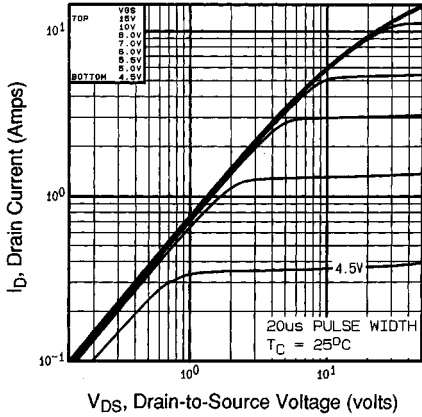

Fig 1. Typical Output Characteristics,
 $T_C=25^\circ\text{C}$

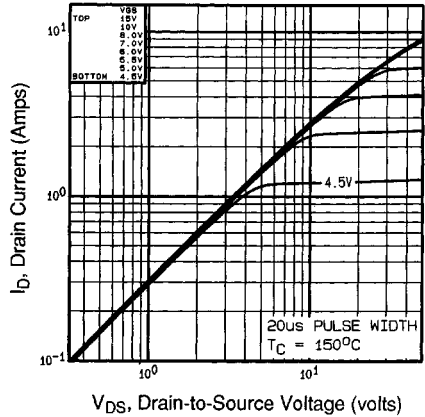

Fig 2. Typical Output Characteristics,
 $T_C=150^\circ\text{C}$

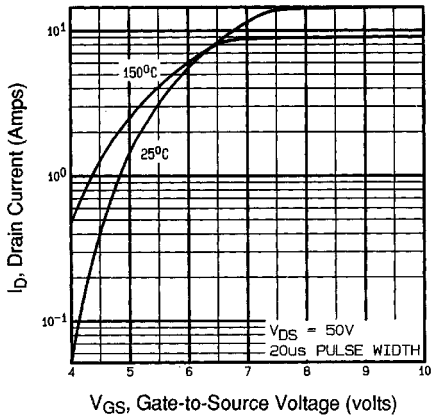

Fig 3. Typical Transfer Characteristics

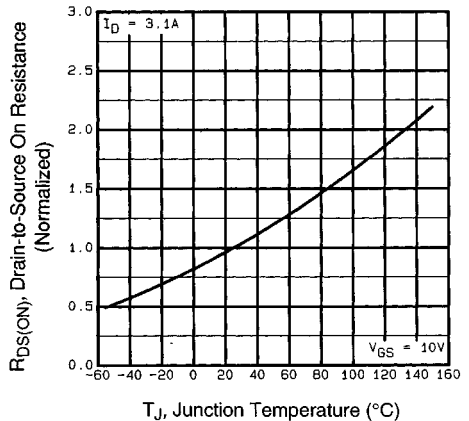

Fig 4. Normalized On-Resistance
Vs. Temperature

DATA SHEETS

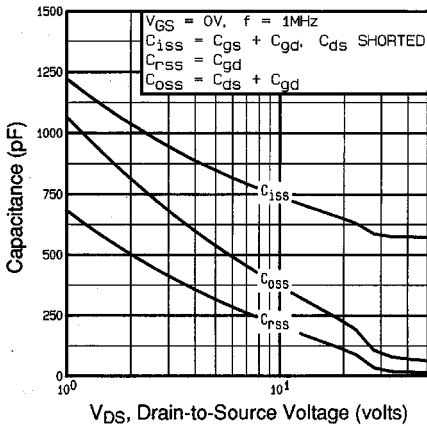

Fig 5. Typical Capacitance Vs. Drain-to-Source Voltage

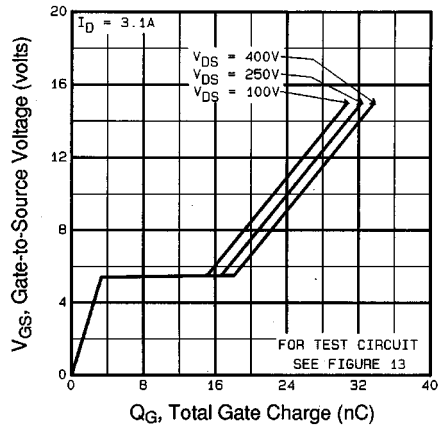

Fig 6. Typical Gate Charge Vs. Gate-to-Source Voltage

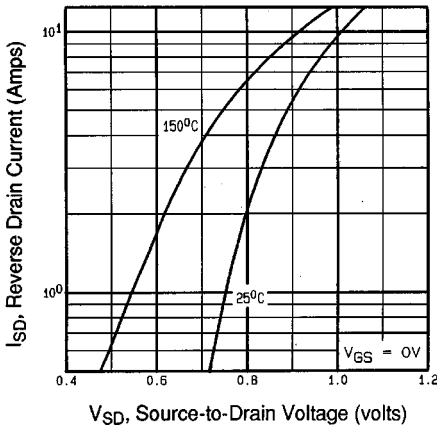

Fig 7. Typical Source-Drain Diode Forward Voltage

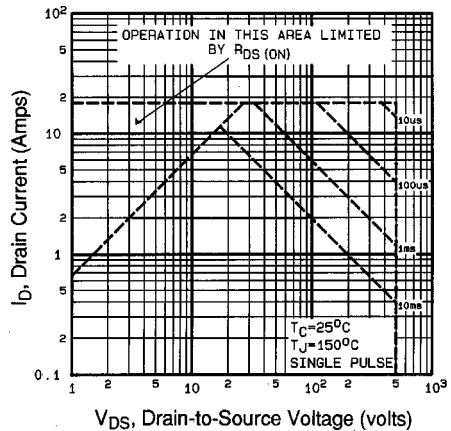

Fig 8. Maximum Safe Operating Area

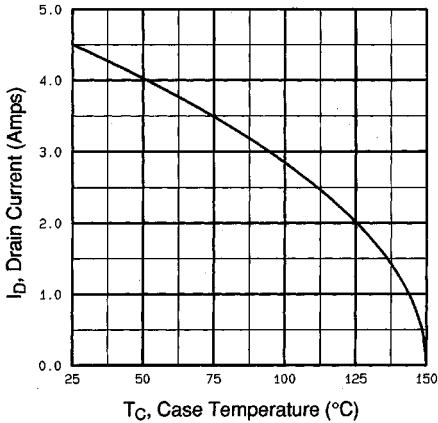

Fig 9. Maximum Drain Current Vs. Case Temperature

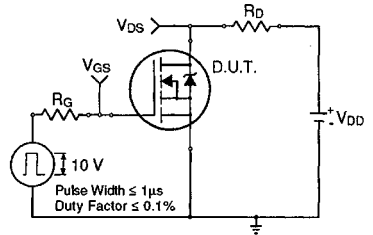

Fig 10a. Switching Time Test Circuit

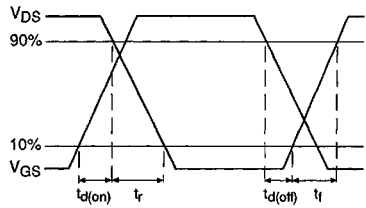

Fig 10b. Switching Time Waveforms

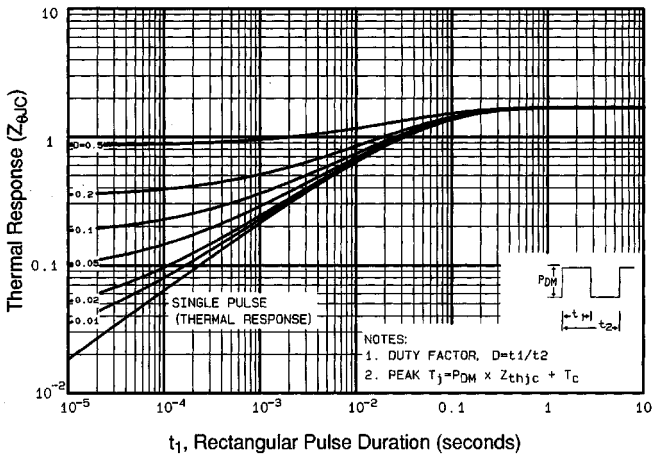

Fig 11. Maximum Effective Transient Thermal Impedance, Junction-to-Case

DATA SHEETS

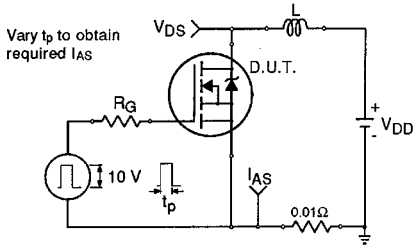

Fig 12a. Unclamped Inductive Test Circuit

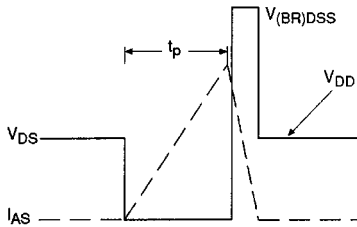

Fig 12b. Unclamped Inductive Waveforms

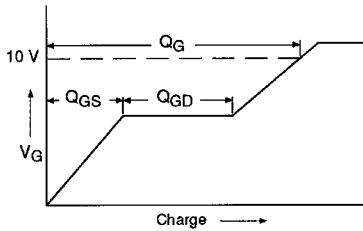

Fig 13a. Basic Gate Charge Waveform

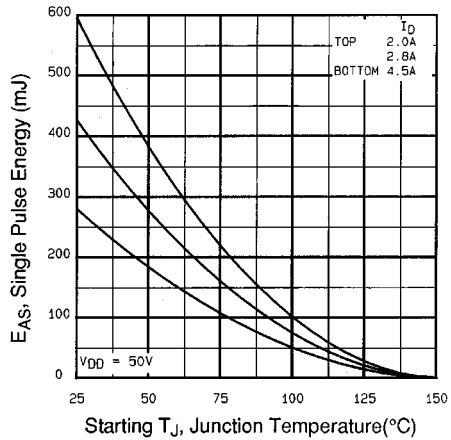

Fig 13c. Maximum Avalanche Energy Vs. Drain Current

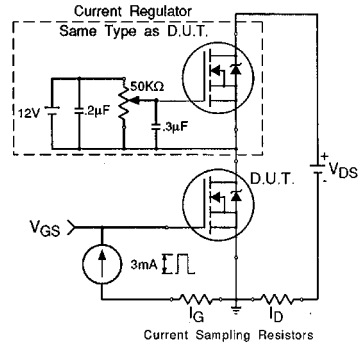

Fig 13b. Gate Charge Test Circuit

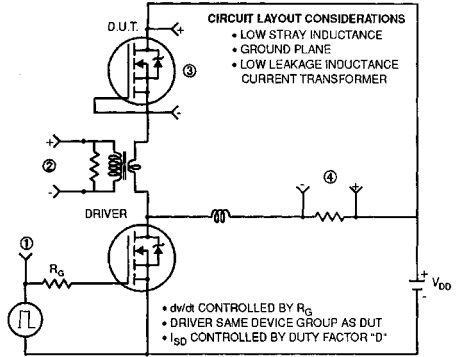
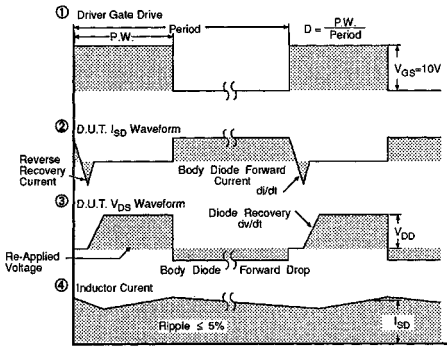

Fig 14. Peak Diode Recovery dv/dt Test Circuit

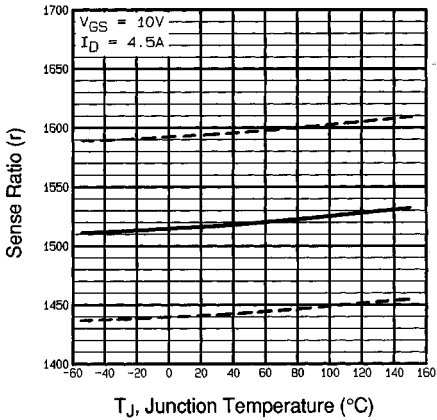

Fig 15. Typical HEXSense Ratio Vs. Junction Temperature

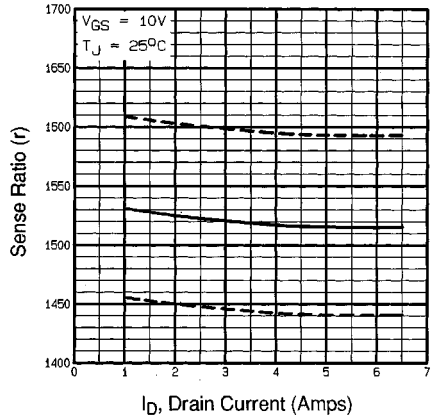

Fig 16. Typical HEXSense Ratio Vs. Drain Current

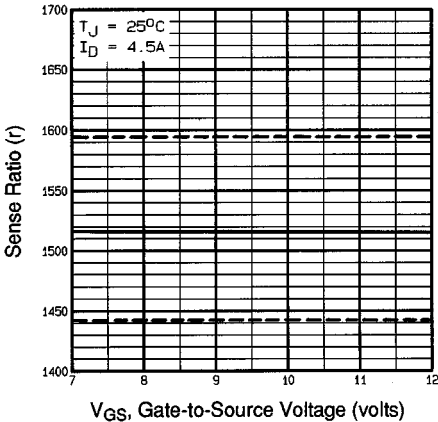
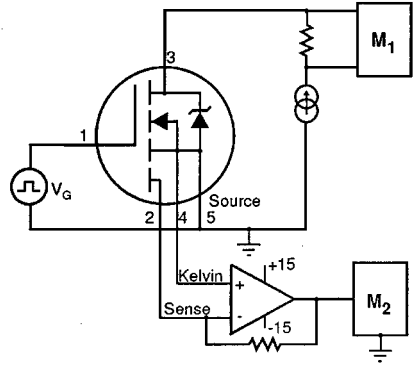

Fig 17. Typical HEXSense Ratio Vs. Gate Voltage



M1, M2 = HIGH SPEED DIGITAL VOLTMETERS

Fig 18. HEXSense Ratio Test Circuit

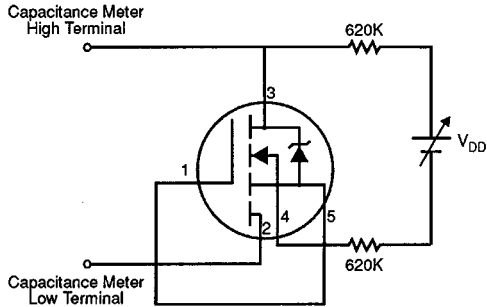



Fig 19. HEXSense Sensing Cell Output Capacitance Test Circuit

Appendix B: Package Outline Mechanical Drawing – See page 1510







Appendix C: Part Marking Information – See page 1517

Looking for pricing, stock, or lifecycle information?

Click below to explore more details on WIN SOURCE:

-  [View IRC830PBF on WIN SOURCE](#)
-  [Vishay Information](#)

Optimize Your Supply Chain with WIN SOURCE

-  Global Sourcing Solution
-  Obsolete Management
-  Cost Control Management
-  Shortage Management
-  Alternative Solution
-  Excess Inventory Management