



**THE DATASHEET OF
MAX6800UR31D3+T**



MAX6800/MAX6801/ MAX6802

3-Pin, Low-Power μ P Reset Circuits

General Description

The MAX6800/MAX6801/MAX6802 microprocessor (μ P) supervisory circuits monitor the power supplies in 2.85V to 5.0V μ P and digital systems. They increase circuit reliability and reduce cost by eliminating external components and adjustments.

These devices perform a single function—they assert a reset signal whenever the V_{CC} supply voltage declines below a preset threshold, keeping it asserted for a preset timeout period after V_{CC} has risen above the reset threshold. The only difference among the three devices is their output. The MAX6801 (push/pull) and MAX6802 (open-drain) have an active-low $\overline{\text{RESET}}$ output, while the MAX6800 (push/pull) has an active-high RESET output. The devices are guaranteed to be in the correct state for V_{CC} down to 0.7V. The MAX6802 is guaranteed to be in the correct state for V_{CC} down to 1.0V.

The reset comparator in these ICs is designed to ignore fast transients on V_{CC} . Reset thresholds are factory-trimmable between 2.63V and 4.80V, in approximately 100mV increments. These devices are available with a 1ms (min), 20ms (min), or 100ms (min) reset pulse width. Ideal for space-critical applications, the MAX6800/MAX6801/MAX6802 come packaged in a 3-pin SOT23. For a lower threshold voltage version, see the MAX6332/MAX6333/MAX6334.

Applications

- Computers
- Controllers
- Intelligent Instruments
- Critical μ P/ μ C Power Monitoring
- Portable/Battery-Powered Equipment

Selector Guide (Standard Versions) appears at end of data sheet.*

Benefits and Features

- Ultra-Low 0.7V Operating Supply Voltage
- Low 4.0 μ A Supply Current
- Precision Monitoring of 2.85V to 5.0V Power-Supply Voltages
- Reset Thresholds Available from 2.63V to 4.80V, in Approximately 100mV Increments
- Fully Specified over Temperature
- Three Power-On Reset Timeout Periods Available (1ms min, 20ms min, 100ms min)
- Low Cost
- Three Available Output Structures: Push/Pull $\overline{\text{RESET}}$, Push/Pull $\overline{\text{RESET}}$, Open-Drain $\overline{\text{RESET}}$
- Guaranteed $\overline{\text{RESET}}/\overline{\text{RESET}}$ Valid to $V_{CC} = 0.7\text{V}$ (MAX6800/MAX6801)
- Power-Supply Transient Immunity
- No External Components Required
- 3-Pin SOT23 Package
- Pin-Compatible with MAX809/MAX810, MAX6326/MAX6327/MAX6328, and MAX6346/MAX6347/MAX6348

Typical Operating Circuit

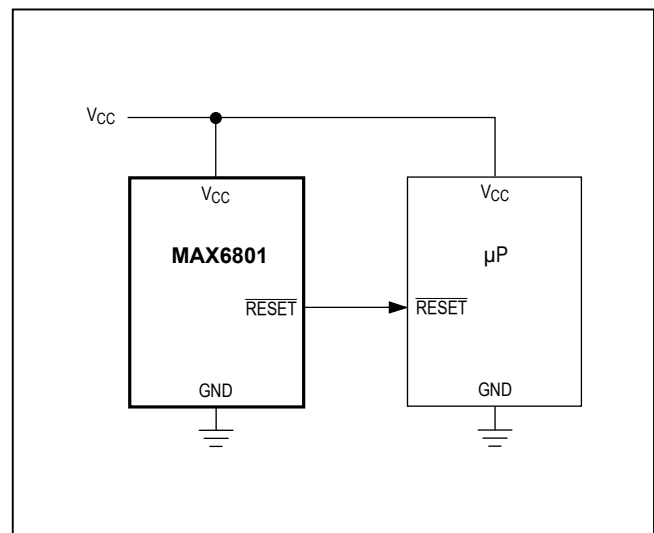

Absolute Maximum Ratings

Terminal Voltage (with respect to GND)	Operating Temperature Range.....	-40°C to +125°C
V_{CC}	Junction Temperature.....	+150°C
Push/Pull RESET, $\overline{\text{RESET}}$	Storage Temperature Range.....	-65°C to +150°C
Open-Drain RESET.....	Lead Temperature (soldering, 10s).....	+300°C
Input Current (V_{CC}).....	Soldering Temperature (reflow).....	+300°C
Output Current (RESET, $\overline{\text{RESET}}$).....	Lead (Pb)-free packages.....	+260°C
Continuous Power Dissipation ($T_A = +70^\circ\text{C}$)	Package containing lead (Pb).....	+240°C
3-Pin SOT23 (derate 4mW/°C above +70°C).....		320mW

Stresses beyond those listed under "Absolute Maximum Ratings" may cause permanent damage to the device. These are stress ratings only, and functional operation of the device at these or any other conditions beyond those indicated in the operational sections of the specifications is not implied. Exposure to absolute maximum rating conditions for extended periods may affect device reliability.

Electrical Characteristics

(V_{CC} = full range, $T_A = -40^\circ\text{C}$ to $+125^\circ\text{C}$, unless otherwise noted. Typical values are at $V_{CC} = +5.0\text{V}$ and $T_A = +25^\circ\text{C}$, reset not asserted.) (Note 1)

PARAMETER	SYMBOL	CONDITIONS		MIN	TYP	MAX	UNITS
Supply Voltage Range (Note 2)	V_{CC}	$T_A = 0^\circ\text{C}$ to $+125^\circ\text{C}$	MAX6800/MAX6801	0.7		5.5	V
			MAX6802	1.0		5.5	
		$T_A = -40^\circ\text{C}$ to $+125^\circ\text{C}$	MAX6800/MAX6801	0.78		5.5	
			MAX6802	1.2		5.5	
Supply Current	I_{CC}	No load	$V_{CC} = +3.0\text{V}$		4	10	µA
			$V_{CC} = +5.0\text{V}$		5	12	
Reset Threshold	V_{TH}	MAX680_UR__D_-T, Table 1	$T_A = +25^\circ\text{C}$	V_{TH} - 1.8%	V_{TH}	V_{TH} + 1.8%	V
			$T_A = -40^\circ\text{C}$ to $+125^\circ\text{C}$	V_{TH} - 3%	V_{TH}	V_{TH} + 3%	
V_{CC} Falling Reset Delay		V_{CC} falling at 10V/ms			30		µs
Reset Active Timeout Period	t_{RP}	MAX680_UR__D1-T		1	1.5	2	ms
		MAX680_UR__D2-T		20	30	40	
		MAX680_UR__D3-T		100	150	200	
$\overline{\text{RESET}}$ Output Low-Voltage (MAX6801/MAX6802)	V_{OL}	Reset asserted	$I_{SINK} = 50\mu\text{A}, V_{CC} \geq 1.0\text{V}$			0.4	V
			$I_{SINK} = 1.2\text{mA}, V_{CC} \geq 2.5\text{V}$			0.3	
			$I_{SINK} = 1.2\text{mA}, V_{CC} \geq 4.25\text{V}$			0.4	
$\overline{\text{RESET}}$ Output High-Voltage (MAX6801)	V_{OH}	Reset not asserted	$I_{SOURCE} = 500\mu\text{A}, V_{CC} \geq 3.0\text{V}$	$0.8 \times V_{CC}$			V
			$I_{SOURCE} = 800\mu\text{A}, V_{CC} \geq 5.0\text{V}$	$0.8 \times V_{CC}$			
RESET Output Voltage (MAX6800)	V_{OH}	Reset asserted	$I_{SOURCE} = 1\mu\text{A}, V_{CC} \geq 1.0\text{V}$	$0.8 \times V_{CC}$			V
			$I_{SOURCE} = 200\mu\text{A}, V_{CC} \geq 1.8\text{V}$	$0.8 \times V_{CC}$			
			$I_{SOURCE} = 800\mu\text{A}, V_{CC} \geq 4.25\text{V}$	$0.8 \times V_{CC}$			
	V_{OL}	Reset not asserted	$I_{SINK} = 1.2\text{mA}, V_{CC} \geq 3.0\text{V}$			0.3	
$I_{SINK} = 3.2\text{mA}, V_{CC} \geq 5.0\text{V}$					0.4		
$\overline{\text{RESET}}$ Output Leakage Current (MAX6802)		$V_{CC} > V_{TH}, \overline{\text{RESET}}$ not asserted				0.5	µA

Note 1: All parts are production tested at $T_A = +25^\circ\text{C}$. Overtemperature limits are guaranteed by design and not production tested.

Note 2: I_{SOURCE} for the MAX6800 is 100nA. I_{SINK} for the MAX6801 is 100nA. I_{SINK} for the MAX6802 is 50µA.

Typical Operating Characteristics

(Reset not asserted, $T_A = +25^\circ\text{C}$, unless otherwise noted.)

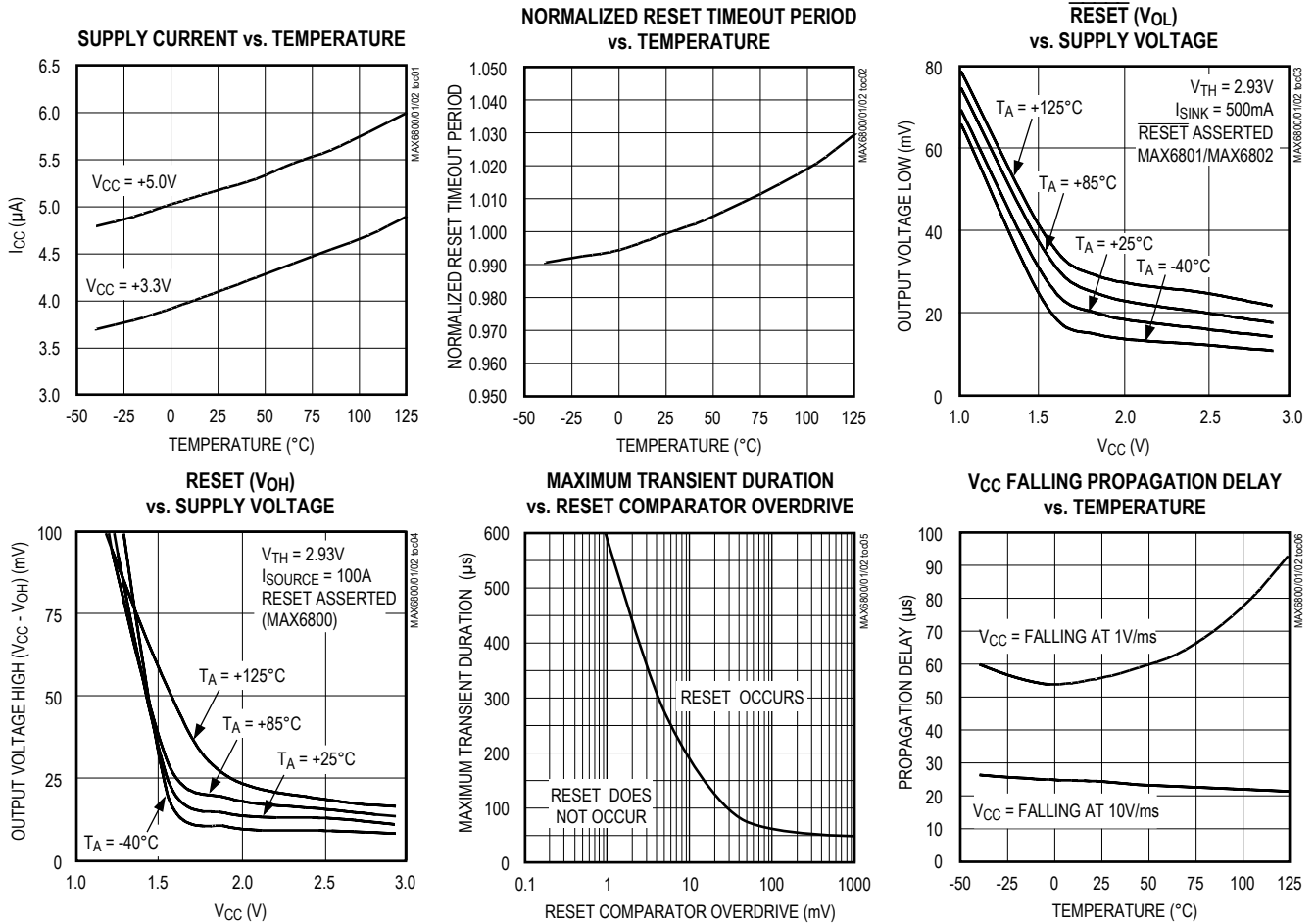

Pin Configuration

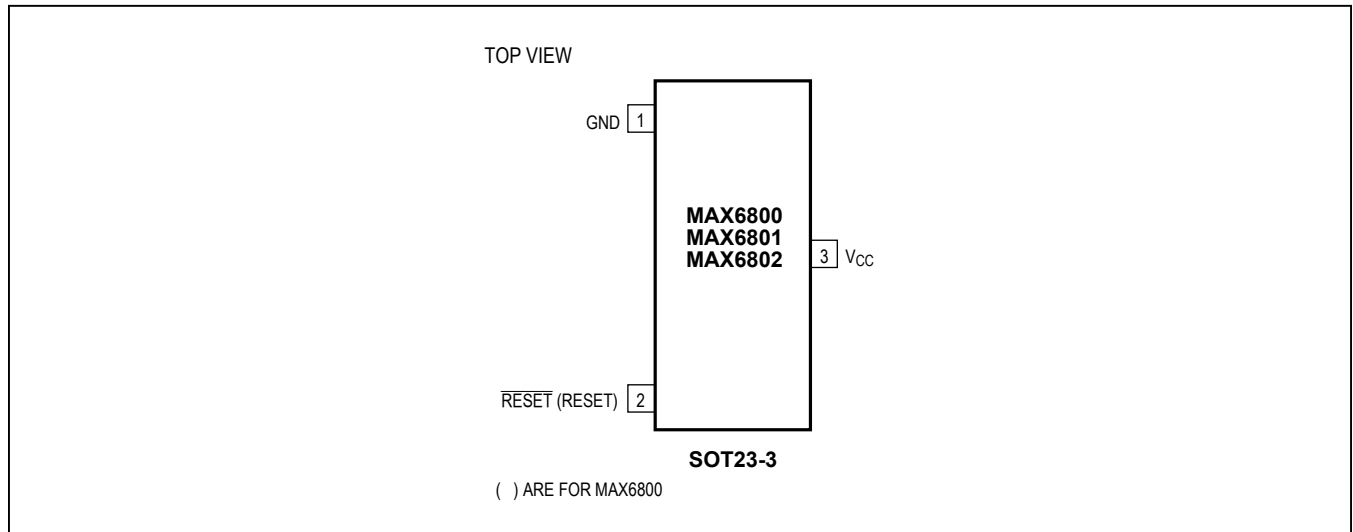

Pin Description

PIN		NAME	FUNCTION
MAX6800	MAX6801/ MAX6802		
1	1	GND	Ground
—	2	$\overline{\text{RESET}}$	Active-Low Reset Output. $\overline{\text{RESET}}$ is asserted while V_{CC} is below the reset threshold and remains asserted for a reset timeout period (t_{RP}) after V_{CC} rises above the reset threshold. $\overline{\text{RESET}}$ on the MAX6801 is push/pull. $\overline{\text{RESET}}$ on the MAX6802 is open-drain.
2	—	RESET	Active-High Reset Output. RESET is asserted while V_{CC} is below the reset threshold and remains asserted for a reset timeout period (t_{RP}) after V_{CC} rises above the reset threshold. RESET on the MAX6800 is push/pull.
3	3	V_{CC}	Supply Voltage Input

Applications Information

Interfacing to μPs with Bidirectional Reset Pins

Since the $\overline{\text{RESET}}$ output on the MAX6802 is open-drain, this device interfaces easily with μPs that have bidirectional reset pins, such as the Motorola 68HC11. Connecting the μP supervisor's $\overline{\text{RESET}}$ output directly to the microcontroller's (μC's) $\overline{\text{RESET}}$ pin with a single pullup resistor allows either device to assert reset (Figure 1).

Negative-Going V_{CC} Transients

In addition to issuing a reset to the μP during power-up, power-down, and brownout conditions, these devices are relatively immune to short-duration, negative-going V_{CC} transients (glitches). The *Typical Operating Characteristics* show the Maximum Transient Duration vs. Reset Comparator Overdrive graph. The graph shows the maximum pulse width that a negative-going V_{CC} transient may typically have without issuing a reset signal. As the amplitude of the transient increases, the maximum allowable pulse width decreases.

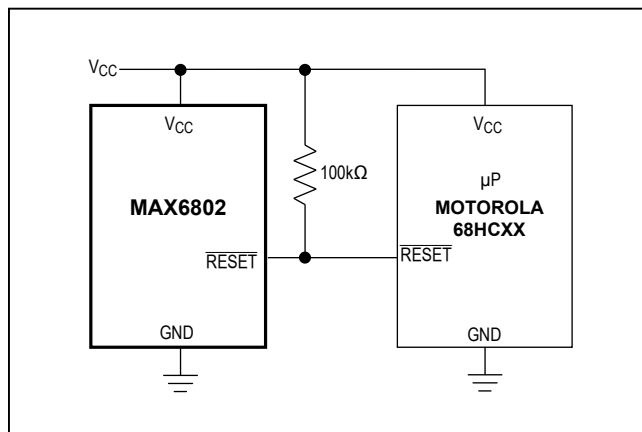

Figure 1. Interfacing to μPs with Bidirectional Reset Pins

Ensuring a Valid Reset Output Down to $V_{CC} = 0V$

When V_{CC} falls below 1V and approaches the minimum operating voltage of 0.7V, push/pull-structured reset sinking (or sourcing) capabilities decrease drastically. High-impedance CMOS-logic inputs connected to the $\overline{\text{RESET}}$ pin can drift to indeterminate voltages. This does not present a problem in most cases, since most μPs and circuitry do not operate when V_{CC} drops below 1V. For the MAX6801 application, where $\overline{\text{RESET}}$ must be valid down to 0V, adding a pulldown resistor between $\overline{\text{RESET}}$ and GND removes stray leakage currents, holding $\overline{\text{RESET}}$ low (Figure 2a). The pulldown resistor value is not critical; 100kΩ is large enough not to load $\overline{\text{RESET}}$ and small enough to pull it low. For the MAX6800 application, where $\overline{\text{RESET}}$ must be valid to $V_{CC} = 0V$, a 100kΩ pullup resistor between $\overline{\text{RESET}}$ and V_{CC} will hold $\overline{\text{RESET}}$ high when V_{CC} falls below 0.7V (Figure 2b).

Since the MAX6802 has an open-drain, active-low output, it typically uses a pullup resistor. With this device, $\overline{\text{RESET}}$ will most likely not maintain an active condition, but will drift to a non-active level due to the pullup resistor and the reduced sinking capability of the open-drain device. Therefore, this device is not recommended for applications where the $\overline{\text{RESET}}$ pin is required to be valid down to $V_{CC} = 0V$.

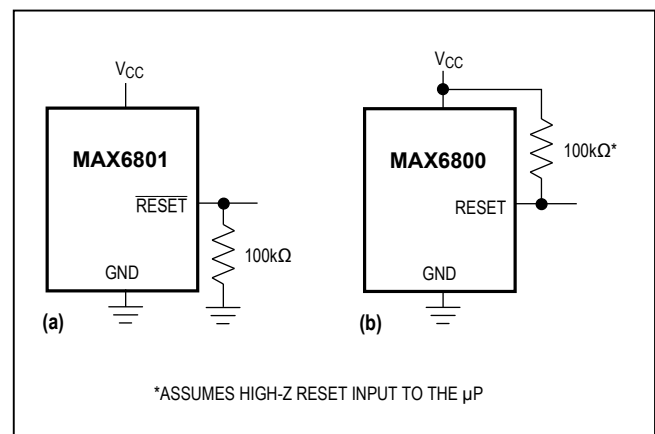

Figure 2. Ensuring Reset Valid Down to $V_{CC} = 0V$

Table 1. Factory-Trimmed Reset Thresholds

RESET THRESHOLD SUFFIX	T _A = +25°C			T _A = -40°C to +125°C	
	MIN	TYP (V _{TH})	MAX	MIN	MAX
48	4.714	4.80	4.886	4.656	4.944
47	4.615	4.70	4.785	4.559	4.841
46	4.547	4.63	4.713	4.491	4.769
45	4.419	4.50	4.581	4.365	4.635
44	4.301	4.38	4.459	4.249	4.511
43	4.223	4.30	4.377	4.171	4.429
42	4.124	4.20	4.276	4.074	4.326
41	4.026	4.10	4.174	3.977	4.223
40	3.928	4.00	4.072	3.880	4.120
39	3.830	3.90	3.970	3.783	4.017
38	3.732	3.80	3.868	3.686	3.914
37	3.633	3.70	3.767	3.589	3.811
36	3.535	3.60	3.665	3.492	3.708
35	3.437	3.50	3.563	3.395	3.605
34	3.339	3.40	3.461	3.298	3.502
33	3.241	3.30	3.359	3.201	3.399
32	3.142	3.20	3.258	3.104	3.296
31	3.025	3.08	3.135	2.988	3.172
30	2.946	3.00	3.054	2.910	3.090
29	2.877	2.93	2.983	2.842	3.018
28	2.750	2.80	2.850	2.716	2.884
27	2.651	2.70	2.749	2.619	2.781
26	2.583	2.63	2.677	2.551	2.709

Selector Guide (Standard Versions*)

PART	OUTPUT STAGE	NOMINAL V _{TH} (V)	MIN RESET TIMEOUT (ms)	SOT TOP MARK
MAX6800UR26D3-T	Push/Pull RESET	2.63	100	FZIE
MAX6800UR29D3-T	Push/Pull RESET	2.93	100	FZIF
MAX6800UR31D3-T	Push/Pull RESET	3.08	100	FZIG
MAX6800UR44D3-T	Push/Pull RESET	4.38	100	FZIH
MAX6800UR46D3-T	Push/Pull RESET	4.63	100	FZII
MAX6801UR26D3-T	Push/Pull $\overline{\text{RESET}}$	2.63	100	FZIK
MAX6801UR29D3-T	Push/Pull $\overline{\text{RESET}}$	2.93	100	FZIM
MAX6801UR31D3-T	Push/Pull $\overline{\text{RESET}}$	3.08	100	FZIN
MAX6801UR44D3-T	Push/Pull $\overline{\text{RESET}}$	4.38	100	FZIO
MAX6801UR46D3-T	Push/Pull $\overline{\text{RESET}}$	4.63	100	FZIP
MAX6802UR26D3-T	Open-Drain RESET	2.63	100	FZIQ
MAX6802UR29D3-T	Open-Drain RESET	2.93	100	FZIR
MAX6802UR31D3-T	Open-Drain RESET	3.08	100	FZIS
MAX6802UR44D3-T	Open-Drain RESET	4.38	100	FZIT
MAX6802UR46D3-T	Open-Drain RESET	4.63	100	FZIU

*Sample stock is generally held on all standard versions.

Ordering Information

PART	TEMP RANGE	PIN-PACKAGE
MAX6800UR__D__-T	-40°C to +125°C	3 SOT23
MAX6801UR__D__-T	-40°C to +125°C	3 SOT23
MAX6802UR__D__-T	-40°C to +125°C	3 SOT23

*These devices are available in factory-set V_{CC} reset thresholds from 2.63V to 4.80V, in approximately 0.1V increments. Choose the desired reset threshold suffix from Table 1 and insert it in the blanks following "UR" in the part number. Factory-programmed reset timeout periods are also available. Insert the number corresponding to the desired nominal reset timeout period (1 = 1ms min, 2 = 20ms min, 3 = 100ms min) in the blank following "D" in the part number. There are 15 standard versions with a required order increment of 2500 pieces. Sample stock is generally held on the standard versions only (see Selector Guide). Contact the factory for availability of non-standard versions (required order increment is 10,000 pieces). All devices available in tape-and-reel only.

Devices are available in both leaded and lead-free packaging. Specify lead-free by replacing "-T" with "+T" when ordering.

Chip Information

PROCESS: BiCMOS

Package Information

For the latest package outline information and land patterns (footprints), go to www.maximintegrated.com/packages. Note that a "+", "#", or "-" in the package code indicates RoHS status only. Package drawings may show a different suffix character, but the drawing pertains to the package regardless of RoHS status.

PACKAGE TYPE	PACKAGE CODE	OUTLINE NO.	LAND PATTERN NO.
3 SOT23	U3-1	21-0051	90-0179

Revision History

REVISION NUMBER	REVISION DATE	DESCRIPTION	PAGES CHANGED
3	10/11	Added automotive-qualified part information to <i>Ordering Information</i> .	1
4	3/12	Updated <i>Factory-Trimmed Reset Thresholds</i> table.	5
5	2/16	Updated <i>Ordering Information</i> table	1

For pricing, delivery, and ordering information, please contact Maxim Direct at 1-888-629-4642, or visit Maxim Integrated's website at www.maximintegrated.com.

Maxim Integrated cannot assume responsibility for use of any circuitry other than circuitry entirely embodied in a Maxim Integrated product. No circuit patent licenses are implied. Maxim Integrated reserves the right to change the circuitry and specifications without notice at any time. The parametric values (min and max limits) shown in the Electrical Characteristics table are guaranteed. Other parametric values quoted in this data sheet are provided for guidance.

Looking for pricing, stock, or lifecycle information?

Click below to explore more details on WIN SOURCE:

- ⊖ [View MAX6800UR31D3+T on WIN SOURCE](#)
- ⊖ [Maxim Integrated Information](#)

Optimize Your Supply Chain with WIN SOURCE Solutions

- ✓ Global Sourcing Solution
- ✓ Obsolete Management
- ✓ Cost Control Management
- ✓ Shortage Management
- ✓ Alternative Solution
- ✓ Excess Inventory Management