



**THE DATASHEET OF
MP62131ES-LF-Z**



DESCRIPTION

The MP62130/MP62131 Power Distribution Switch features internal current limiting to prevent damage to host devices due to faulty load conditions. The MP62130/MP62131 Analog switch features 90mΩ on-resistance and operates from 2.7V to 5.5V input. It is available with a guaranteed current limit, making it ideal for load switching applications. The MP62130/MP62131 has built-in protection for both over current and increased thermal stress. For over current, the device will limit the current by changing to a constant current mode.

As the temperature increases as a result of short circuit, the device will shut off. The device will recover once the device temperature reduces to approx 120°C.

The MP62130/MP62131 is available in MSOP8 and SOIC8 packages.

FEATURES

- 500mA Continuous Current
- Accurate Current Limit
- Output Discharge Function
- 2.7V to 5.5V Supply Range
- 95μA Quiescent Current
- 90mΩ MOSFET
- Thermal-Shutdown Protection
- Under-Voltage Lockout
- 8ms FLAG Deglitch Time
- No FLAG Glitch During Power Up
- Reverse Current Blocking
- MSOP8 and SOIC8 Packages

APPLICATIONS

- Smartphone and PDA
- Portable GPS Device
- Set-top-box
- USB Power Distribution

*MPS® and "The Future of Analog IC Technology" are Trademarks of Monolithic Power Systems, Inc.

TYPICAL APPLICATION

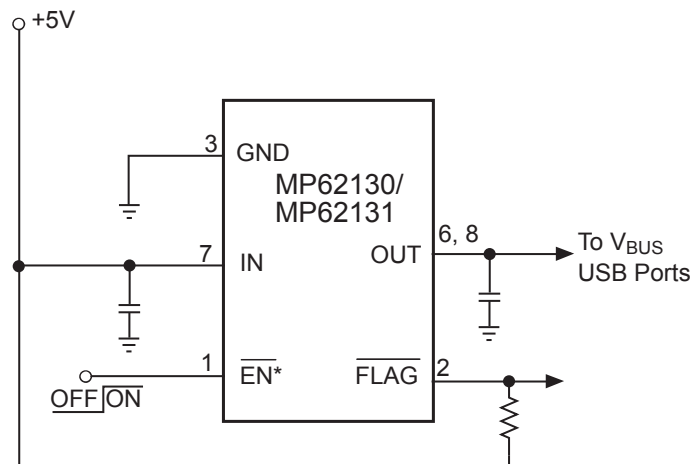

*EN is active high for 62131
 SINGLE-CHANNEL

ORDERING INFORMATION

| Part Number | Enable | Switch | Maximum Continuous Load Current | Typical Short-Circuit Current @ T _A =25°C | Package | Top Marking | Free Air Temperature (T _A) |
|-------------|-------------|--------|---------------------------------|--|---------|-------------|--|
| MP62130ES | Active Low | Single | 500mA | 650mA | SOIC8 | MP62130 | -20°C to +85°C |
| MP62130EK* | | | | | MSOP8 | 62130 | |
| MP62131ES | Active High | | | | SOIC8 | MP62131 | |
| MP62131EK* | | | | | MSOP8 | 62131 | |

* For Tape & Reel, add suffix –Z (e.g. MP62130/MP62131EK–Z).

For RoHS Compliant packaging, add suffix –LF (e.g. MP62130/MP62131EK–LF–Z);

PACKAGE REFERENCE

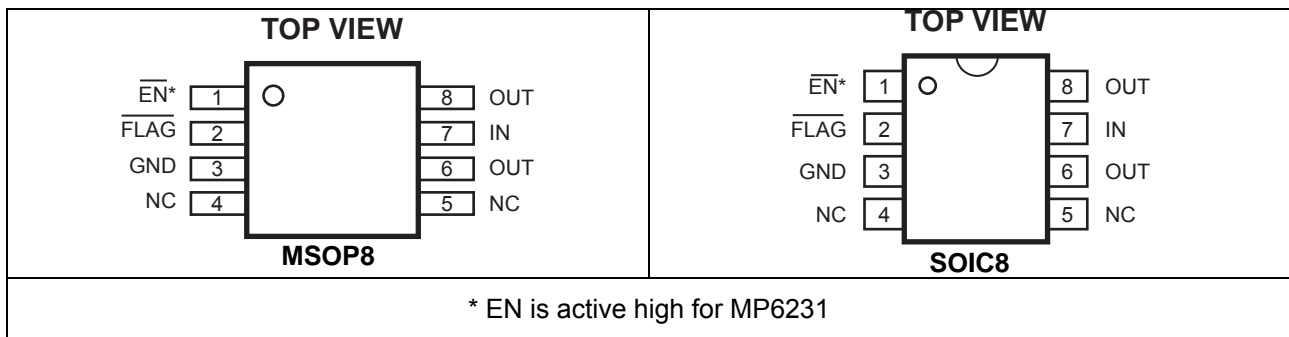

ABSOLUTE MAXIMUM RATINGS ⁽¹⁾

| | |
|--|-----------------|
| IN | -0.3V to +6.5V |
| EN, FLAG, OUT to GND | -0.3V to +6.5V |
| Continuous Power Dissipation (T _A = +25°C) ⁽²⁾ | |
| MSOP8 | 0.83W |
| SOIC8..... | 1.4W |
| Junction Temperature | 150°C |
| Lead Temperature | 260°C |
| Storage Temperature..... | -65°C to +150°C |
| Operating Junct. Temp (T _J)..... | -20°C to +125°C |

| Thermal Resistance ⁽³⁾ | θ _{JA} | θ _{JC} |
|-----------------------------------|-----------------|-----------------|
| MSOP8 | 150 | 65... °C/W |
| SOIC8 | 90 | 42... °C/W |

Notes:

- Exceeding these ratings may damage the device.
- The maximum allowable power dissipation is a function of the maximum junction temperature T_J (MAX), the junction-to-ambient thermal resistance θ_{JA}, and the ambient temperature T_A. The maximum allowable continuous power dissipation at any ambient temperature is calculated by P_D (MAX) = (T_J (MAX)-T_A)/θ_{JA}. Exceeding the maximum allowable power dissipation will cause excessive die temperature, and the regulator will go into thermal shutdown. Internal thermal shutdown circuitry protects the device from permanent damage.
- Measured on JESD51-7 4-layer PCB.

ELECTRICAL CHARACTERISTICS ⁽⁴⁾

$V_{IN}=5V$, $T_A=+25^{\circ}C$, unless otherwise noted.

| Parameter | Condition | Min | Typ | Max | Units |
|--|--|------|-----|------|-------------|
| IN Voltage Range | | 2.7 | | 5.5 | V |
| Supply Current | Single Channel | 75 | 95 | 160 | μA |
| Shutdown Current | Device Disable, $V_{OUT}=\text{float}$, $V_{IN}=5.5V$ | | 1 | | μA |
| Off Switch Leakage | Device Disable, $V_{IN}=5.5V$ | | 1 | | μA |
| Current Limit | | 550 | 650 | 1100 | mA |
| Trip Current | Current Ramp (slew rate $\leq 100A/s$) on Output | | 1.2 | | A |
| Under-voltage Lockout | Rising Edge | 1.95 | 2.3 | 2.65 | V |
| Under-voltage Hysteresis | | 100 | 250 | 400 | mV |
| FET On Resistance | $I_{OUT}=100mA$ ($-20^{\circ}C \leq T_A \leq 85^{\circ}C$) | | 90 | 130 | m Ω |
| EN Input Logic High Voltage | | 2 | | | V |
| EN Input Logic Low Voltage | | | | 0.8 | V |
| FLAG Output Logic Low Voltage | $I_{SINK}=5mA$ | | | 0.4 | V |
| FLAG Output High Leakage Current | $V_{IN}=V_{FLAG}=5.5V$ | | | 1 | μA |
| Thermal Shutdown | | | 140 | | $^{\circ}C$ |
| Thermal Shutdown Hysteresis | | | 20 | | $^{\circ}C$ |
| V_{OUT} Rising Time, T_r ⁽⁵⁾ | $V_{IN}=5.5V$, $C_L=1\mu F$, $R_L=11\Omega$ | | 0.9 | 2 | ms |
| | $V_{IN}=2.7V$, $C_L=1\mu F$, $R_L=11\Omega$ | | 1.7 | 2.7 | ms |
| V_{OUT} Falling Time, T_f ⁽⁵⁾ | $V_{IN}=5.5V$, $C_L=1\mu F$, $R_L=11\Omega$ | | 0.1 | 0.5 | ms |
| | $V_{IN}=2.7V$, $C_L=1\mu F$, $R_L=11\Omega$ | | 0.1 | 0.5 | ms |
| Turn On Time, T_{on} ⁽⁶⁾ | $C_L=100\mu F$, $R_L=11\Omega$ | | 1.8 | 3 | ms |
| Turn Off Time, T_{off} ⁽⁶⁾ | $C_L=100\mu F$, $R_L=11\Omega$ | | 2 | 10 | ms |
| Discharge Resistance | | | 100 | | Ω |
| FLAG Deglitch Time | | 4 | 8 | 15 | ms |
| EN Input Leakage | | | 1 | | μA |
| Reverse Leakage Current | $V_{OUT}=5.5V$, $V_{IN}=\text{GND}$ | | 0.2 | | μA |

Notes:

- 4) Production test at $+25^{\circ}C$. Specifications over the temperature range are guaranteed by design and characterization.
- 5) Measured from 10% to 90% output signal.
- 6) Measured from 50% EN signal to 90% output signal.

PIN FUNCTIONS

| Pin # | Name | Description |
|-------|--------------------------|---|
| 1 | $\overline{\text{EN}}^*$ | Enable Input. Active High(MP62131); Active Low(MP62130) |
| 2 | $\overline{\text{FLAG}}$ | IN-to-OUT Over-current, active-low output flag. Open-Drain. |
| 3 | GND | Ground. |
| 4, 5 | NC | |
| 6, 8 | OUT | Power-Distribution Switch Output. |
| 7 | IN | Input Voltage. Accepts 2.7V to 5.5V input. |

TYPICAL PERFORMANCE CHARACTERISTICS

$T_A = +25^\circ\text{C}$, unless otherwise noted.

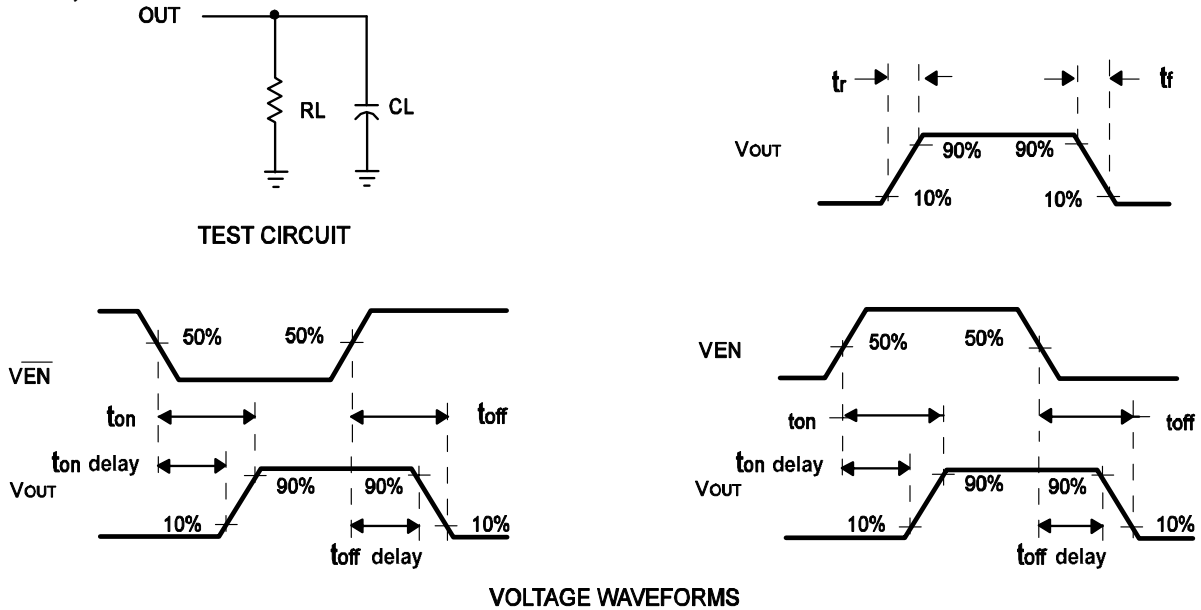
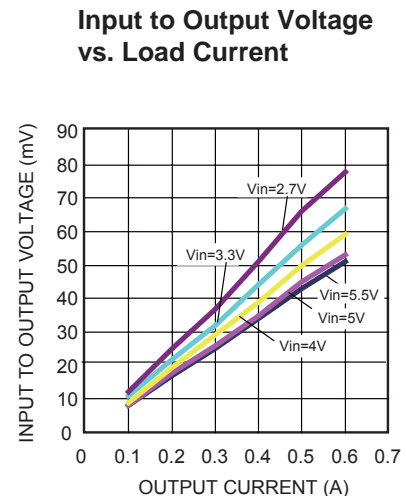
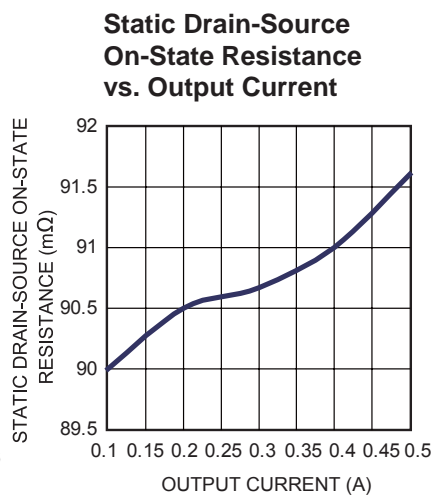
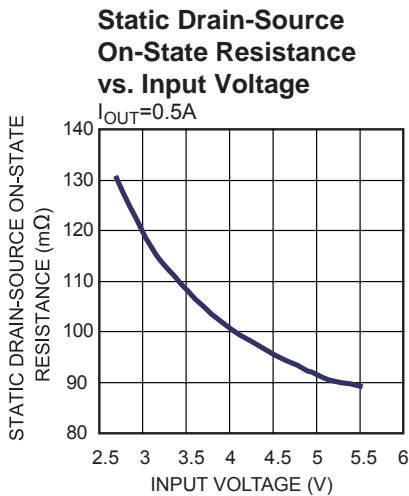
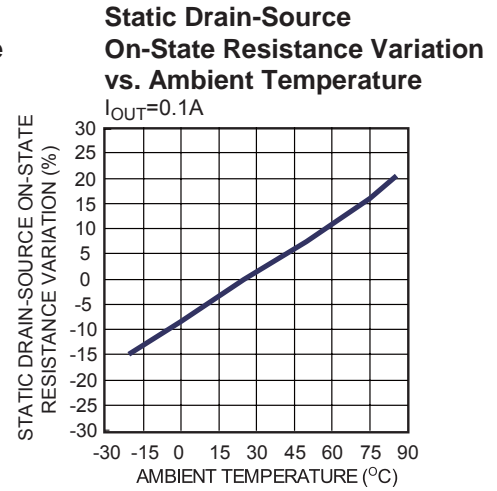
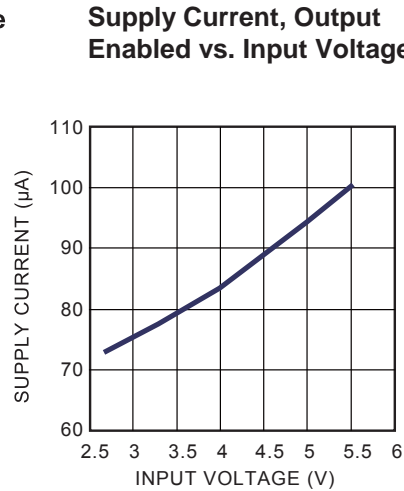
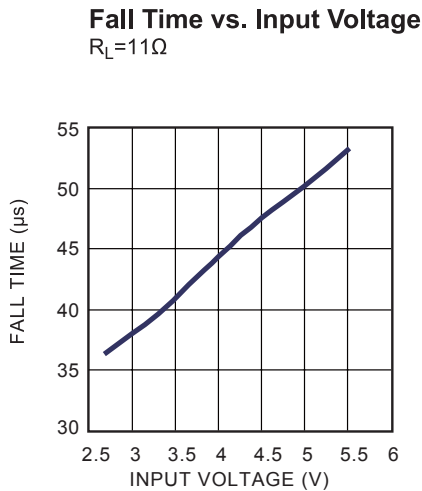
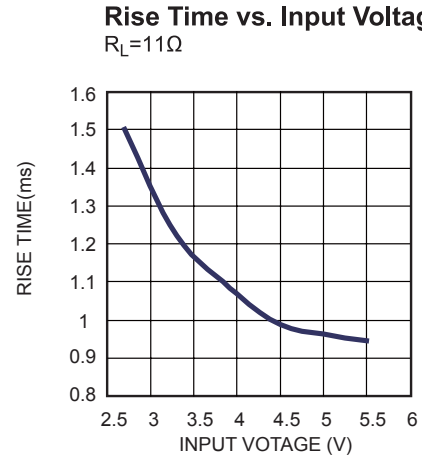
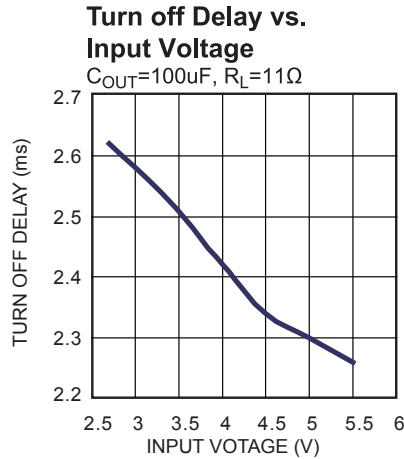
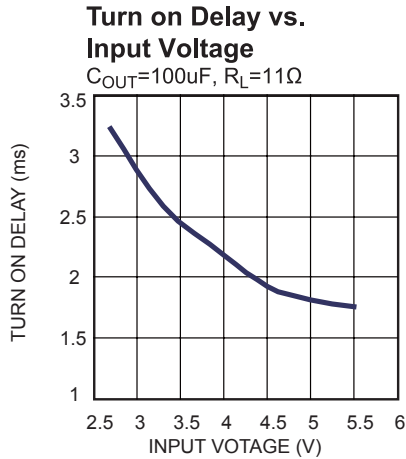

Figure 1—Test Circuit and Voltage Waveforms

TYPICAL PERFORMANCE CHARACTERISTICS

$V_{IN} = 5V$, $V_{EN} = 0V$ for MP62130 or 5v for MP62131, $C_L = 1\mu F$, $T_A = +25^\circ C$, unless otherwise noted.

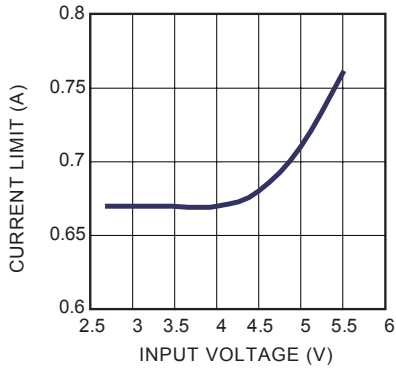
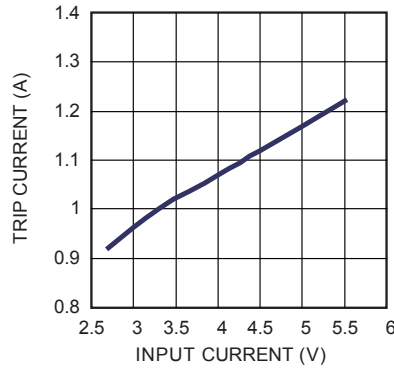
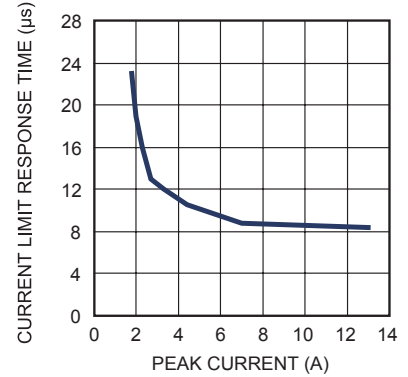
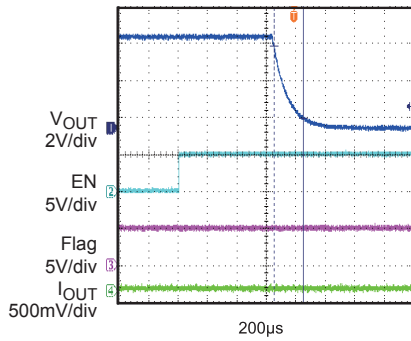
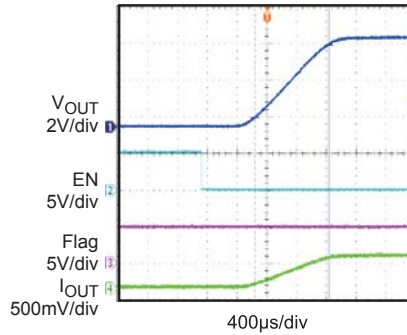
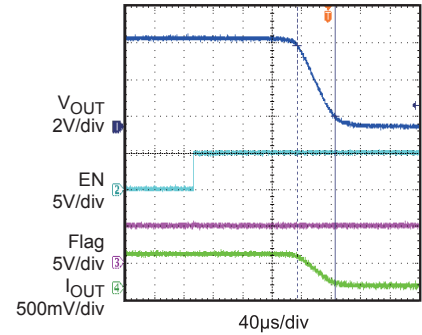
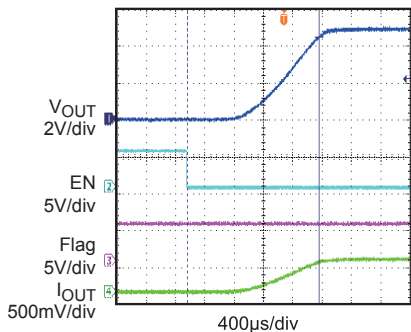
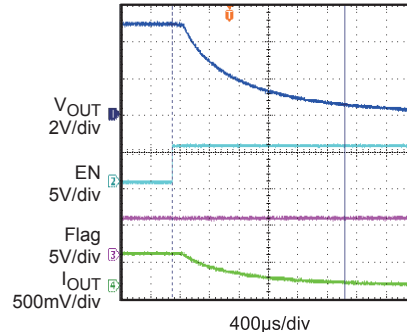
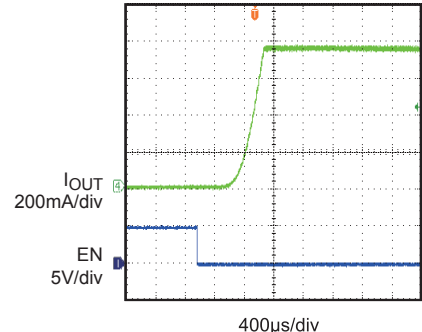

TYPICAL PERFORMANCE CHARACTERISTICS (continued)
 $V_{IN} = 5V$, $V_{EN} = 0V$ for MP62130 or 5v for MP62131, $C_L = 1\mu F$, $T_A = +25^\circ C$, unless otherwise noted.

Current Limit vs. Input Voltage

Threshold Trip Current vs. Input Voltage

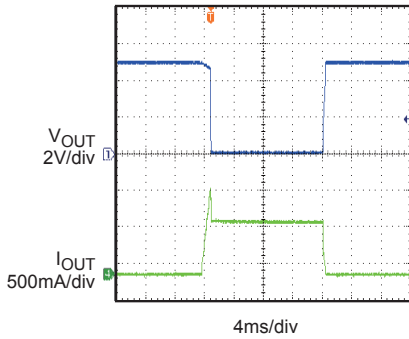
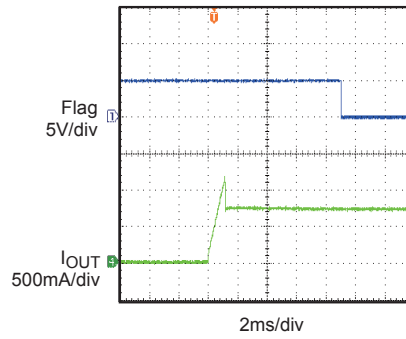
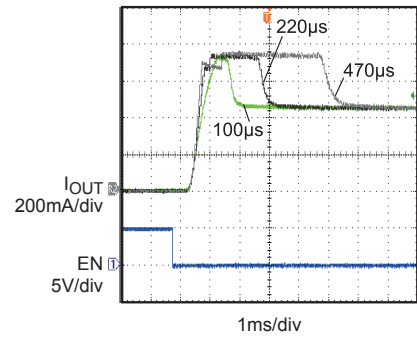
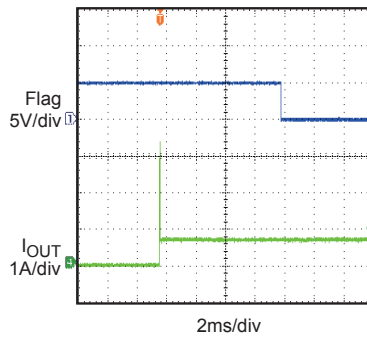
Current Limit Response vs. Peak Current

Turn Off Delay and Fall Time with Output Discharge
 $I_{OUT} = 0A$

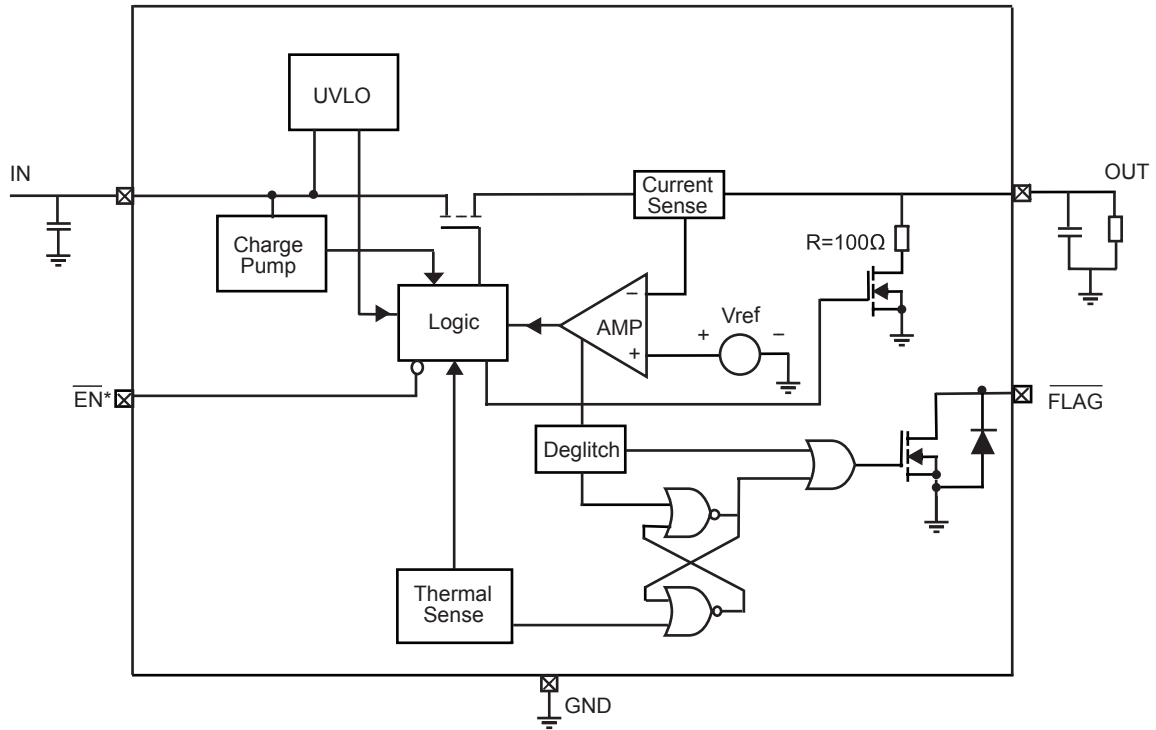
Turn On Delay and Rise Time with 1µF Load
 $I_{OUT} = 0.5A$

Turn Off Delay and Fall Time with 1µF Load
 $I_{OUT} = 0.5A$

Turn On Delay and Rise Time with 100µF Load
 $I_{OUT} = 0.5A$

Turn Off Delay and Fall Time with 100µF Load
 $I_{OUT} = 0.5A$

Short Circuit Current, Device Enabled into Short

TYPICAL PERFORMANCE CHARACTERISTICS (continued)
 $V_{IN} = 5V$, $V_{EN} = 0V$ for MP62130 or 5v for MP62131, $C_L = 1\mu F$, $T_A = +25^\circ C$, unless otherwise noted.

Threshold Trip Current with Ramped Load on Enabled Device

Ramped Load on Enabled Device

Inrush Current with Different Load Capacitance
 $I_{OUT} = 0.5A$

1Ω Load Connected to Enabled Device

FUNCTION BLOCK DIAGRAM



* EN is active high for MP62131

Figure 2—Functional Block Diagram

DETAILED DESCRIPTION

Over Current

When the load exceeds trip current (minimum threshold current triggering constant-current mode) or a short is present, MP62130/MP62131 switches into to a constant-current mode (current limit value). MP62130/MP62131 will be shutdown only if the overcurrent condition stays long enough to trigger thermal protection.

Trigger overcurrent protection for different overload conditions occurring in applications:

- 1) The output has been shorted or overloaded before the device is enabled or input applied. MP62130/MP62131 detects the short or overload and immediately switches into a constant-current mode.
- 2) A short or an overload occurs after the device is enabled. After the current-limit circuit has been tripped (reached the trip current threshold), the device switches into constant-current mode. However, high current may flow for a short period of time before the current-limit circuit can react.
- 3) Output current has been gradually increased beyond the recommended operating current. The load current rises until the trip current threshold is reached or until the thermal limit of the device is exceeded. The MP62130/MP62131 is capable of delivering current up to the trip current threshold without damaging the device. Once the trip threshold has been reached, the device switches into its constant-current mode.

Flag Response

The FLAG pin is an open drain configuration. This FAULT will report a fail mode after an 8ms deglitch timeout. This is used to ensure that no false fault signals are reported. This internal deglitch circuit eliminates the need for extend components. The FLAG pin is not deglitched during an over temperature or voltage lockout.

Thermal Protection

The purpose of thermal protection is to prevent damage in the IC by allowing excessive current to flow and heating the junction. The die temperature is internally monitored until the thermal limit is reached. Once this temperature is reached, the switch will turn off and allow the chip to cool. The switch has a built-in hysteresis.

Under-Voltage Lockout (UVLO)

This circuit is used to monitor the input voltage to ensure that the MP62130/MP62131 is operating correctly. This UVLO circuit also ensures that there is no operation until the input voltage reaches the minimum spec.

Enable

The logic pin disables the chip to reduce the supply current. The device will operate once the enable signal reaches the appropriate level. The input is compatible with both COMS and TTL.

Output Discharge

The part involves a discharge function that provides a resistive discharge path for the external output capacitor. The function will be active when the part is disabled (Input voltage is under UVLO or enable is deasserted) and it will be done in a very limited time.

APPLICATION INFORMATION

Power-Supply Considerations

A 10µF bypass capacitor between IN and GND, close to the device, is recommended. Placing a high-value electrolytic capacitor on the output pin(s) is recommended when the output load is

heavy. This precaution reduces power-supply transients that may cause ringing on the input. Optionally, bypassing the output with a 0.01µF to 0.1µF ceramic capacitor improves the immunity of the device to short-circuit transients.

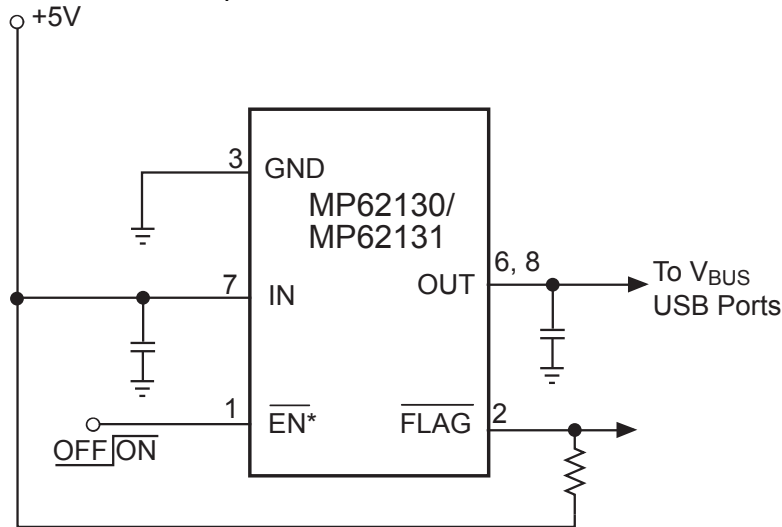

*EN is active high for 62131
SINGLE-CHANNEL

Figure 3—Application Circuit

PACKAGE INFORMATION

MSOP8

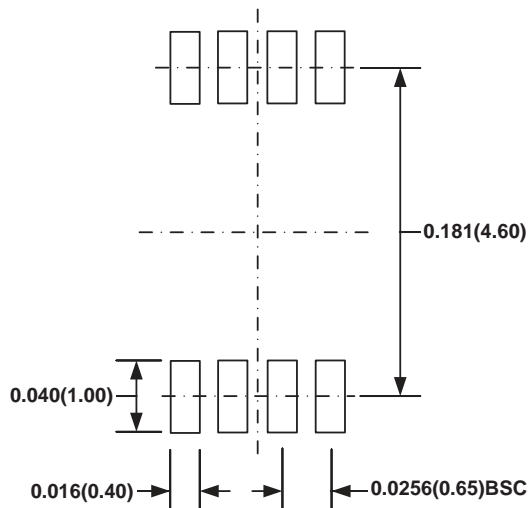
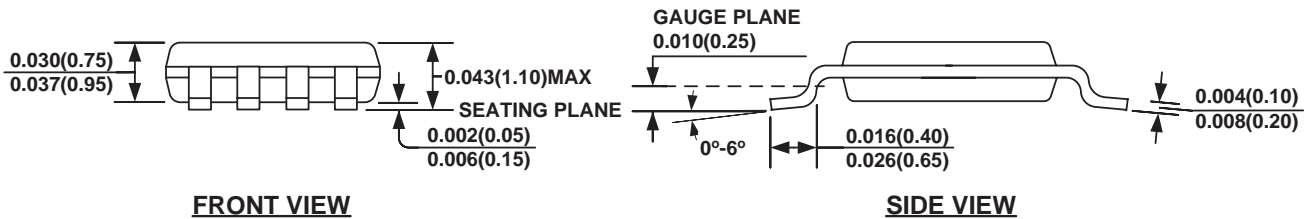
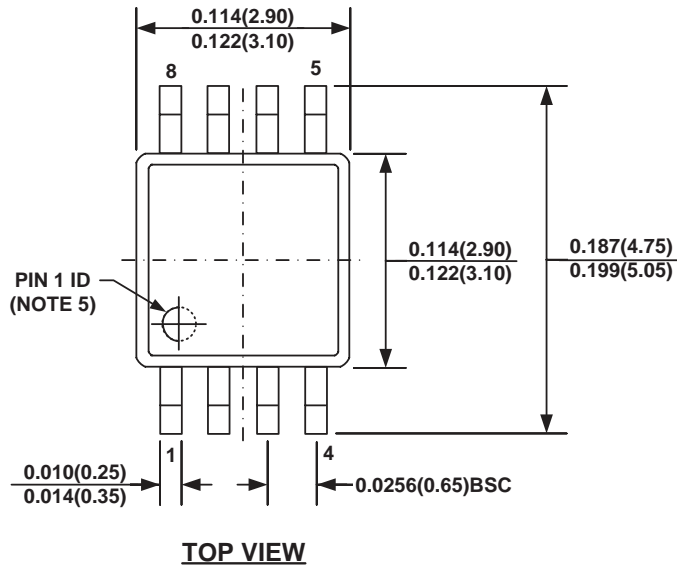

NOTE:

- 1) CONTROL DIMENSION IS IN INCHES. DIMENSION IN BRACKET IS IN MILLIMETERS.
- 2) PACKAGE LENGTH DOES NOT INCLUDE MOLD FLASH, PROTRUSION OR GATE BURR.
- 3) PACKAGE WIDTH DOES NOT INCLUDE INTERLEAD FLASH OR PROTRUSION.
- 4) LEAD COPLANARITY (BOTTOM OF LEADS AFTER FORMING) SHALL BE 0.004" INCHES MAX.
- 5) PIN 1 IDENTIFICATION HAS HALF OR FULL CIRCLE OPTION.
- 6) DRAWING MEETS JEDEC MO-187, VARIATION AA.
- 7) DRAWING IS NOT TO SCALE.

SOIC8

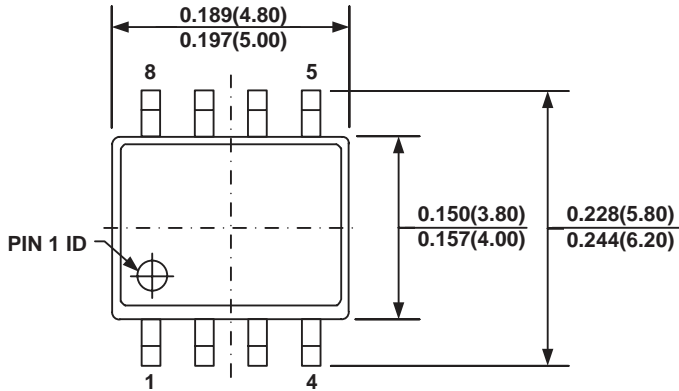

TOP VIEW

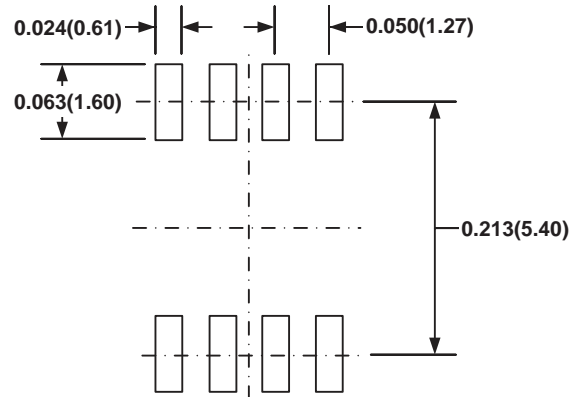

RECOMMENDED LAND PATTERN

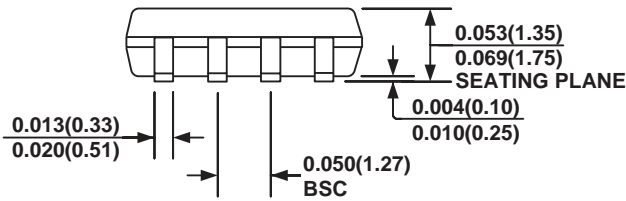

FRONT VIEW

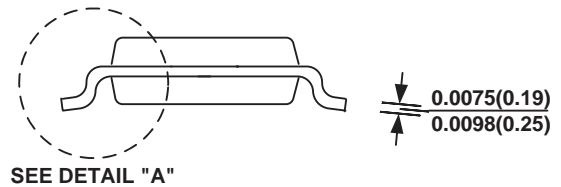

SIDE VIEW

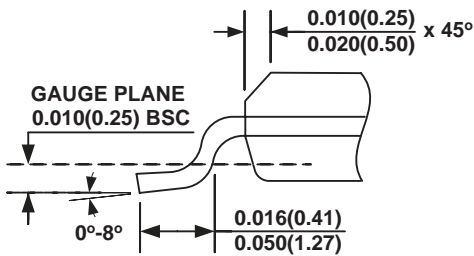

DETAIL "A"



NOTE:

- 1) CONTROL DIMENSION IS IN INCHES. DIMENSION IN BRACKET IS IN MILLIMETERS.
- 2) PACKAGE LENGTH DOES NOT INCLUDE MOLD FLASH, PROTRUSIONS OR GATE BURRS.
- 3) PACKAGE WIDTH DOES NOT INCLUDE INTERLEAD FLASH OR PROTRUSIONS.
- 4) LEAD COPLANARITY (BOTTOM OF LEADS AFTER FORMING) SHALL BE 0.004" INCHES MAX.
- 5) DRAWING CONFORMS TO JEDEC MS-012, VARIATION AA.
- 6) DRAWING IS NOT TO SCALE.

NOTICE: The information in this document is subject to change without notice. Users should warrant and guarantee that third party Intellectual Property rights are not infringed upon when integrating MPS products into any application. MPS will not assume any legal responsibility for any said applications.

Looking for pricing, stock, or lifecycle information?

Click below to explore more details on WIN SOURCE:

-  [View MP62131ES-LF-Z on WIN SOURCE](#)
-  [Monolithic Power Systems Inc. Information](#)

Optimize Your Supply Chain with WIN SOURCE Solutions

-  Global Sourcing Solution
-  Obsolete Management
-  Cost Control Management
-  Shortage Management
-  Alternative Solution
-  Excess Inventory Management